

### GENERAL

The IMC LonTalk® module allows communication between the Lennox IMC M1-7 (version 5.02 and higher) or M1-8 controller and a LonWorks® network. The module translates input and output variables between the Lennox protocol and the LonTalk® protocol.

The IMC LonTalk® Module has been developed to communicate with building automation systems. The functional profiles are proprietary in content and will require the integrator to use the datapoint information included in this manual.

A Lennox zone sensor or a LonTalk® network zone sensor may be used to send the zone temperature to the IMC.

### Table of Contents

Hardware Specifications	1
Network Cable	2
Configuring IMC Unit Controller	2
Data Update Rate	3
Start Up Unit Operation	3
Normal Unit Operation	3
Communication Check Out	4
Communication Failure	4
Network Connection	4
Network Limits	4
Free Topology Networks	4
Network Bus Integration	5
Network Bus Termination	5
LonTalk® Datapoints	6
Zone Sensor Setpoints	8
IMC Alarm Codes	8
Interpretation of Datapoints	9

**Table 1. IMC LonTalk® Hardware Specifications**

<b>ELECTRICAL</b>	
Power Supply	24VAC 50/60Hz (18-30VAC)
Power consumption	< =7 watts
Connector	Two position terminal block ( <b>Polarity Sensitive</b> ) ( <b>Hot, Com</b> )
<b>ENVIRONMENT</b>	
Operating Temperature range	-40F to 155F
Storage temperature range	-40F to 185F
RH	10-95% RH non-condensing
<b>FIELD CONNECTIONS</b>	
<b>LonWorks®</b>	
Transceiver	FTT-10A
Connector	Two position terminal block
Baud Rate	78K
Cable Type	Twisted pair Belden type 8471 or NEMA Level 4.
Max. Cable Length	See Network Limits Section
Bus Termination	1 or 2 termination circuit module required depending on network topology. Lennox part #37X75
<b>LENNOX SysBus</b>	RS485
Connector	Two position terminal block
Baud Rate	9600
Cable Type	Twisted pair w/shield, 22AWG min. Belden type 88761 or 8761. Lennox 27M19, 94L63 or 68M25.
Max. Cable Length	4000 ft. Repeater is required for longer lengths
Bus Termination	None
<b>PHYSICAL</b>	
Dimensions	3.1 x 3.5 x 1.25 IN. (WxDxH)
Weight	0.1 lbs (0.04Kg)
PCB Material	FR4 Conformal coated
Mounting	Four brass 5 in. standoffs for #6 screws.

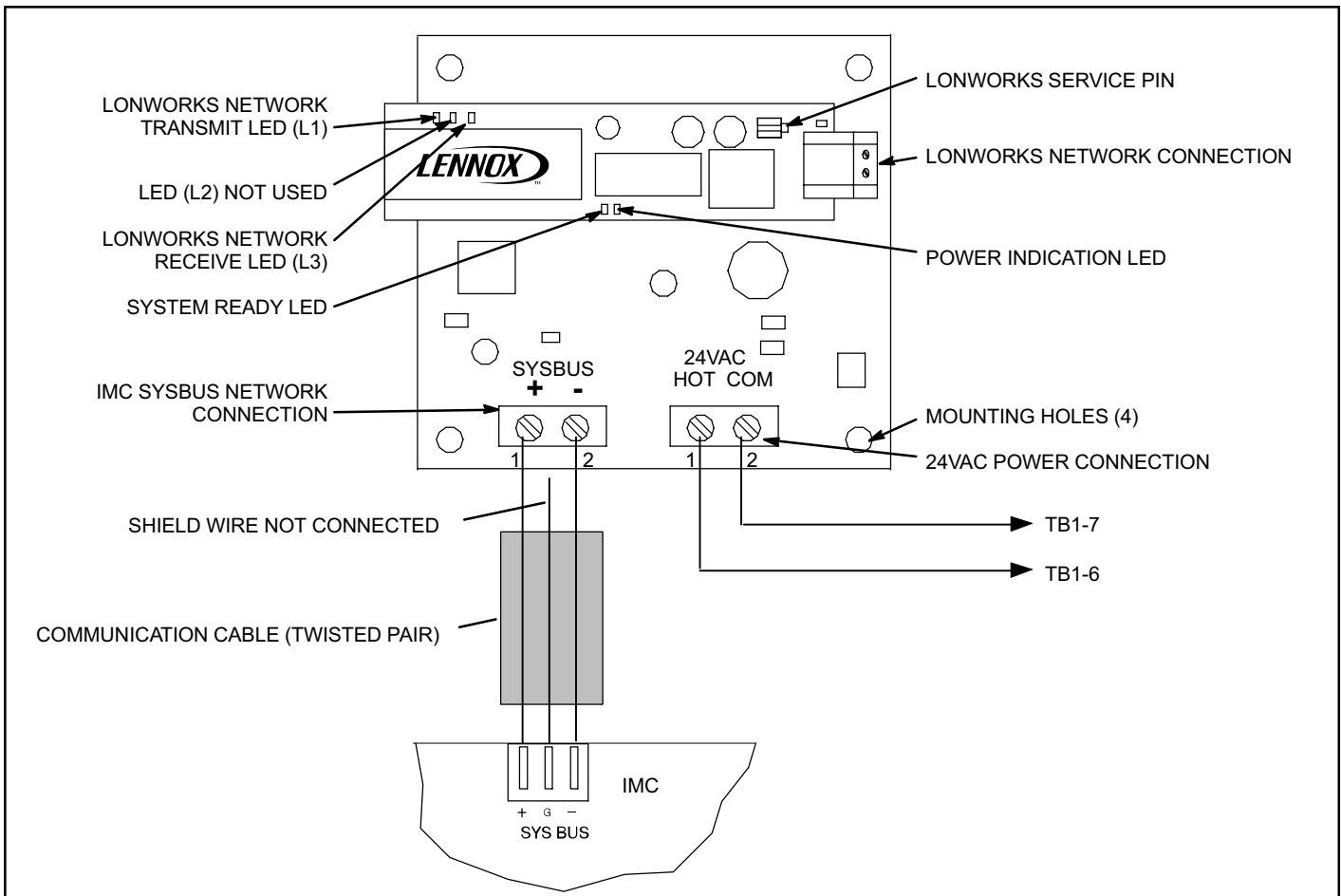

Figure 1. LonTalk® Module and Connections

### Network Cable

The LonWorks® TP/FT-10 network requires Echelon qualified twisted-pair communication cables such as Belden 8471 or NEMA Level 4 cables (see figure 1).

Other Echelon approved equivalent cables may also be used depending on the application. The Belden® 8471 or NEMA Level 4 cables are rated for plenum use.

The network cable should be routed using best practices to avoid induced noise. Do not route alongside power lines, or in proximity to high voltage or high frequency devices, such as ignition controls and variable frequency drives. The average temperature of the wire must not exceed 131°F (55°C).

## ⚠ IMPORTANT

A qualified systems integrator with adequate training and experience is required to integrate and commission the IMC LonTalk® module into a third party LonWorks® building automation system. A LonWorks commissioning software tool is required to commission the LonWorks network.

### Configuring the IMC Unit Controller

#### ECTO Settings

Use the IMC pushbutton and DIP switches to manually adjust the following control parameters (see IMC manual). A PC can also be used with Unit Controller software and a PC converter.

#### Lennox Zone Sensor Installed:

1. Set ECTO 6.01 to option 3 (zone sensor system mode with return air sensor back-up).
2. Set ECTO 6.17 to option 1 (continuous blower during occupied).
3. Set ECTO 6.02-6.05 as specified (back-up occupied and unoccupied heating and cooling setpoints).

#### LonTalk® Zone Sensor Installed:

1. Set ECTO 6.01 to option 3 (zone sensor system mode with return air temperature back-up).
2. Set ECTO 6.17 to option 1 (continuous blower during occupied).
3. Set ECTO 5.27 to option 2 (network zone sensor option).

#### IMC Settings

1. Be sure the occupied 24 VAC input is energized by adding a jumper wire between TB1-8 and 9. In the event that communication is lost between the IMC

LonTalk module and the IMC, the IMC will operate in the occupied mode and use the occupied backup setpoints.

2. Change IMC UNIT ADDRESS DIP switch to 2. See figure 2 and 3.

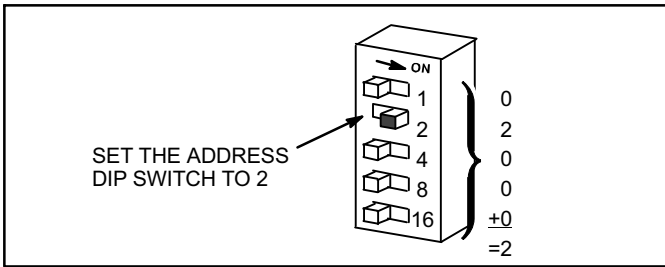

**Figure 2. Address DIP Switch**

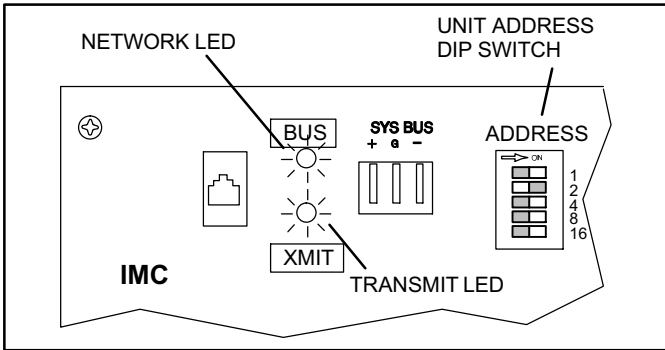

**Figure 3. IMC LEDs**

**Technical Assistance**

For assistance contact Lennox Technical Support at 800-453-6669.

**IMC Version Required**

This module requires a rooftop unit IMC M1-7 (version 5.02 or higher) or M1-8. An IMC upgrade kit is available for earlier M1-7 versions. M1-6 and earlier IMC versions cannot be upgraded for use with the LonTalk module. M1-8 displays version when powered up in the scrolling text (may need to clear error codes). For displaying version on M1-7:

1. Locate IMC board in compressor area. Refer to IMC manual provided with rooftop unit.
2. Set the MODE DIP “UNIT TEST” and “RECALL” switches to “ON”. See figure 4.
3. The IMC LEDs will display the current IMC version.
4. Be certain to return the “UNIT TEST” and “RECALL” switches to “OFF” after viewing the version number. Communication to the IMC is interrupted while these MODE DIP switches are “ON”.

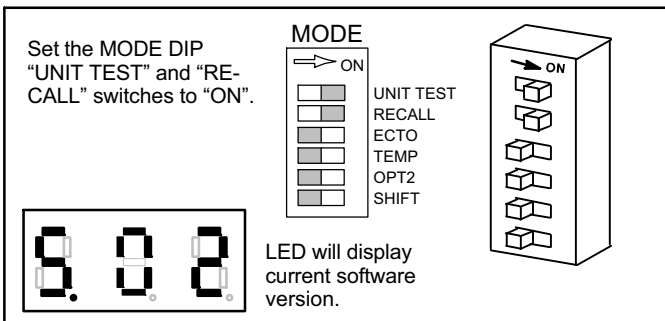

**Figure 4. Check Software Version and Address**

**Data Update Rate**

If a LonTalk Zone Sensor is installed (ECTO 5.27), the nvi-SpaceTemp point must be updated periodically. If nvi-SpaceTemp is not updated for a period of 5 minutes, the IMC will go into the back-up modes described in the “LonTalk Connection Failure” section.

**It is highly recommended that the nviSpaceTemp variable, if it is used, be updated at least every 2 minutes.**

**Acknowledged service, also known as critical binding, must be used for all points of control.**

**Start Up Unit Operation—Before LonWorks® Network is Commissioned**

**Lennox Zone Sensor Installed:**

Two minutes after power-up (ECTO 5.25), the IMC will operate the unit based on the IMC ECTO unoccupied backup setpoints (heating = 60°F, cooling = 85°F) and current zone temperature read by the Lennox zone sensor.

After commissioning, the LonWorks setpoint can be used. If not commissioned, then the IMC backup set points will continue to be used.

**LonTalk Zone Sensor Installed:**

Prior to commissioning, neither LonWorks setpoint nor sensor data are available. The unit will be off.

Five minutes after power-up, the IMC will operate the unit based on the IMC ECTO unoccupied backup setpoints (heating = 60°F, cooling = 85°F) and the current zone temperature read by an additional Lennox zone sensor if installed. If the Lennox zone sensor is not installed, the IMC return air temperature sensor is used as backup (ECTO 6.01).

**Normal Unit Operation—After LonWorks® Network Is Commissioned**

The occupancy of the space can be determined using any combination of the following control points:

- LonWorks Network scheduling
- Manual override
- Space occupancy sensor

**Lennox Zone Sensor Installed:**

The unit is off for up to two minutes after power-up (ECTO 5.25) unless the LonWorks Network sends a setpoint. The unit will operate based on this setpoint and the temperature from the Lennox zone sensor.

In addition to control points, space occupancy can be manually overridden using a Lennox zone sensor equipped with an optional after hours switch.

**LonTalk Zone Sensor Installed:**

The unit is off for up to five minutes after power-up unless the LonWorks Network sends a setpoint and LonTalk zone sensor data. The unit will operate based on this setpoint and temperature data.

## Communication Check

Use table 2 as a guide once the IMC and LonTalk Module are connected and powered. See figure 8.

Use table 3 as a guide once the LonWorks network is set up and operating.

**Table 2. IMC to LonTalk® Module Communication**

LED	Action
IMC BUS and XMIT LEDs flash.	None. Indicates normal communication.
IMC BUS and XMIT LEDs are off.	<ol style="list-style-type: none"> <li>1- Check cable connection between the IMC module.</li> <li>2- Reverse polarity of the cable between the IMC and LonTalk Module.</li> <li>3- Check 24VAC power to LonTalk module.</li> </ol>
IMC BUS LED flashes but XMIT LED is off.	<ol style="list-style-type: none"> <li>1- Make sure MODE DIP RECALL switch is OFF.</li> <li>2- Make sure MODE DIP ECTO switch is OFF.</li> <li>3- Make sure MODE DIP UNIT TEST switch is OFF.</li> </ol>

**Table 3. LonWorks® Network Communication**

LED	Action
LonWorks communication LEDs L1 & L3 flash.	None. Indicates normal communication.
LonWorks communication LED L1 & L3 are off.	<ol style="list-style-type: none"> <li>1- Check LonWorks network connections.</li> <li>2- Make sure LonWorks network is commissioned.</li> <li>3- Make sure 24 volts is connected to the LonWorks module.</li> </ol>

## Connection Failure

Control following a connection failure depends on where the failure occurs, and which input device has been used.

**Table 4. Connection Failure**

	Between IMC and LonTalk Module	LonWorks Network
<b>Lennox Zone Sensor</b>	<ol style="list-style-type: none"> <li>1- During the 5 minutes following a failure, the IMC cycles on last setpoint.</li> <li>2- IMC resets. No heating or cooling during 2 minutes (ECTO 5.25) following reset.</li> <li>3- IMC cycles based on ECTO backup setpoints.</li> <li>4- Occupancy is determined by hardware input at TB1.</li> </ol>	<ol style="list-style-type: none"> <li>1- IMC cycles on last setpoint.</li> <li>2 - Last occupancy input is used.</li> </ol>
<b>LonTalk Zone Sensor</b>	<ol style="list-style-type: none"> <li>1- During 5 minutes following failure, IMC continues current operation: heat, cool, or off.</li> <li>2- IMC resets. No heating or cooling during 5 minutes following reset.</li> <li>3- IMC uses ECTO backup setpoints.</li> <li>4- IMC attempts to use Lennox zone sensor as backup. If this fails, IMC uses return air sensor backup.</li> <li>5- Occupancy is determined by hardware input at TB1.</li> </ol>	<ol style="list-style-type: none"> <li>1- During 5 minutes following failure, IMC continues current operation: heat, cool, or off.</li> <li>2- IMC uses ECTO backup setpoints.</li> <li>3- IMC attempts to use Lennox zone sensor as backup. If this fails, IMC uses return-air-sensor backup.</li> <li>4 - Last occupancy input is used.</li> </ol>

## Network Connection

The IMC LonTalk module has an FTT-10A Free Topology Transceiver for network communication. This transceiver is based on the ANSI/EIA/CEA 709.1 and 709.3 standards. The FTT-10A transceiver network supports free topology wiring and will accommodate bus, star, loop, or any combination of these topologies. The module can be located at any point along the network wiring. This capability simplifies system installation and makes it easier to add nodes when required.

### Network Limits (Free Topology)

The LonWorks TP/FT-10 free topology network is limited

to a maximum of 64 nodes per segment. The maximum total bus length and the maximum node-to-node length is 1640 ft. (500m) for Belden 8471 or NEMA Level 4. Maximum lengths are less for other smaller wire size cables.

Only one termination circuit module is required at any location along the network. Refer to Echelon LonWorks FTT-10 Transceiver User's Guide for additional details.

## Free Topology Networks

Free topology segments require a termination circuit for proper performance. Only one termination circuit module is required at any location along the network. See figure 5.

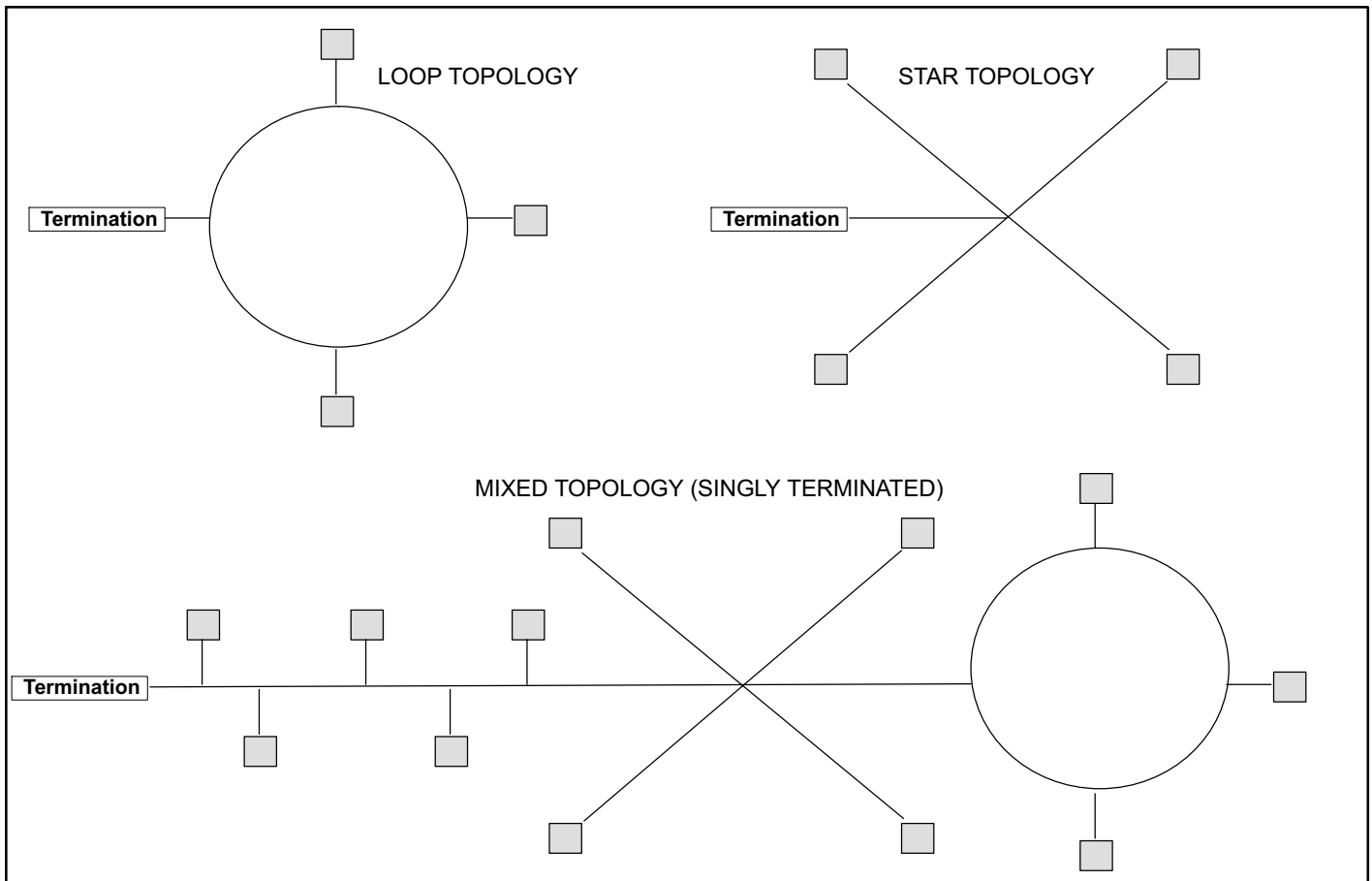

**Figure 5. Free Topology Networks**

**Network Limits (Doubly-Terminated Topology)**

The LonWorks TP/FT-10 Doubly-Terminated topology network is limited to a maximum of 64 nodes per segment. The maximum total bus length is 8900ft. (2700m) for Belden 8471 type cable or 4600ft (1400m) for NEMA Level 4 cable type. Maximum bus lengths are less for other smaller wire size cables.

The maximum stub length is 9.8 ft. (3m). In many cases this bus network is connected in a daisy chain manner where the bus is wired directly to each node, so stub length is zero.

Two termination circuit modules (37X75) are required for each segment. One must be located at each end of the network. See figure 6.

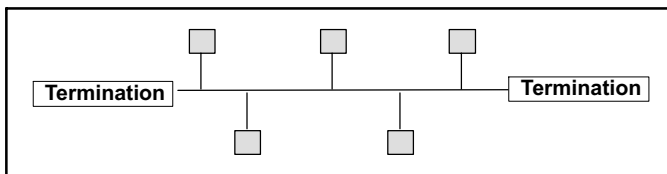

**Figure 6. Doubly Terminated Topology**

**Network Bus Integration**

A network configuration tool such as LonMaker® is required to commission the LonWorks® network. Press the service button on the IMC LonTalk® module to generate a

service message that contains the Neuron ID and all information required to connect it to a system and to configure the module.

Other commissioning methods may be used. The Neuron address is located on the IMC LonTalk module.

An external Interface File (XIF) is available for configuration prior to installation.

**Network Bus Termination**

To install the network bus terminal module 37X75, connect the brown and yellow wires to the network bus that requires single termination and connect the brown and orange wire to the network bus that requires double termination. See figure 7. The unused termination module wire must be covered with a wire nut to prevent potential grounding problems.

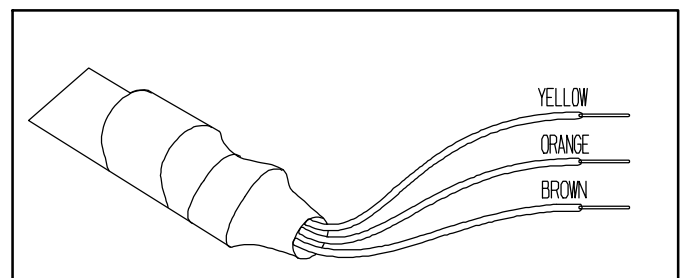

**Figure 7. Network Bus Termination**

## LonTalk<sup>®</sup> Data Points - Inputs (Table 5) and Outputs (Table 6)

The “nvi” and “nvo” prefixes are for standard LonTalk<sup>®</sup> variable names, input and output. These names are as found in the Space Comfort Control and Discharge Air Controller LonMark equipment profiles.

The “snvi” and “snvo” prefixes are for special, manufactur-

er defined, variable names; input and output.

By convention input and output are described from the point of view of the interface module. Inputs are values read by the interface module, and outputs are values written by the interface module.

Table 5. LonWorks <sup>®</sup> Network Variables - Inputs				
LonMarkName	SNVT Index	SNVT Type	SNVT Unit	Description
nviApplicMode	0	SNVT_hvac_mode		Unit application mode
0 - Auto				Heating or cooling. Default after reset.
1 - Heat				Heating only.
3 - Cool				Cooling only.
6 - Off				Unit off.
9 - Fan only				No heating or cooling allowed.
255 - Null				No heating or cooling allowed.
nviOAMinPos	1	SNVT_lev_percent		Min economizer damper position
nviOccManCmd	2	SNVT_occupancy		Zone occupied status
nviOccSchedule	3	SNVT_tod_event		Occupancy scheduler input used to put controller unit into different occupancy modes
nviOccSensor	4	SNVT_occupancy		Occupancy sensor input. Used to indicate the presence of occupants
nviSpaceDehumSP	5	SNVT_lev_percent		Zone relative humidity set point
nviSetpoint	6	SNVT_temp_p	Deg_F	Zone temperature setpoint
nviSetptOffset	7	SNVT_temp_p	Deg_F	Zone temp setpoint offset
nviSpaceTemp	8	SNVT_temp_p	Deg_F	Remote zone temp.
nviEmergOverride	9	SNVT_hvac_emerg		Emergency smoke override
nviComprEnable	10	SNVT_switch		Compressor enable
nviPriHeatEnable	11	SNVT_switch		Primary heat enable
nviAuxHeatEnable	12	SNVT_switch		Auxiliary heat enable
nviDuctStaticSP	57	SNVT_press_f	Inch_H2O	Duct static pressure setpoint
nviBldgStaticSP	58	SNVT_press_f	Inch_H2O	Building static pressure setpoint
nviDACISP	59	SNVT_temp_p	Deg_F	Discharge air cooling setpoint
nviDAHtSP	60	SNVT_temp_p	Deg_F	Discharge air heating setpoint
nviSupFanCap	61	SNVT_lev_cont_f		Supply fan capacity setting
nviExhFanCap	62	SNVT_lev_cont_f		Exhaust fan capacity setting
nviEconEnable	63	SNVT_switch		Economizer enable input

**Table 6. LonWorks Network Variables - Outputs**

LonMarkName	SNVT Index	SNVT Type	SNVT Unit	Description
snvoCommStatus	13	SNVT_count		IMC Communicating
snvoIMCVersion	14	SNVT_str_asc		IMC firmware version. D0-D3 (ASCII)
snvoUnitID	15	SNVT_count		Unit ID. \$3x-Gas/Elect \$4x-Elect/Elect \$5x-Heat Pump
nvoUnitStatus:	16	SNVT_hvac_status		Unit operation mode (i.e. cool, heat, etc.)
1 - HVAC heat				
2 - HVAC morning warmup				
3 - HVAC cool				
5 - HVAC pre-cool				
6 - HVAC off				
7 - HVAC test				
8 - HVAC emergency heat				
9 - HVAC fan only				
12 - HVAC max heat				
14 - HVAC dehumidification				
129 - HVAC fresh air heating				
131 - HVAC fresh air cooling				
145 - HVAC defrost 1				
161 - HVAC defrost 2				
177 - HVAC defrost 1 2				
nvoSpaceTemp	17	SNVT_temp_p	Deg_F	Zone Temperature, effective
nvoDischAirTemp	18	SNVT_temp_p	Deg_F	Supply air temperature
nvoEffectOccup	19	SNVT_occupancy		Zone occupied status
nvoLocalOATemp	20	SNVT_temp_p	Deg_F	Outdoor air temperature
nvoLocalSpaceTemp	21	SNVT_temp_p		Zone Temperature, local
nvoOADamper	22	SNVT_lev_percent		Economizer damper position
nvoHeatPrimary	23	SNVT_lev_percent		Primary heating status
nvoHeatSecondary	24	SNVT_lev_percent		Heat pump electric strip heating status
nvoCoolPrimary	25	SNVT_lev_percent		Cooling compressor 1-4 status (on/off)
nvoEconEnabled	26	SNVT_switch		Economizer outdoor air suitable
nvoSupFanStatus	27	SNVT_switch		Supply fan status
nvoEffectSetpt	28	SNVT_temp_p	Deg_F	Zone temperature set points
snvoCurrentError	29	SNVT_count		Currently displayed error code
snvoErrorPointer	30	SNVT_count		Error pointer. This value points to the next available alarm code location. It runs from 0 to 83 and then returns to 0. Tracking this value and using the ten most recent IMC error codes (next variable) allows an application to 1) determine when new errors are logged by the IMC, 2) what those errors are, and 3) if any errors have been missed due to network delays or other reasons.
snvoMostRecErr1-10	31-40	SNVT_count		Alarm codes listed in the IMC manual
snvoSpaceCO2Eff	41	SNVT_ppm		

table continued on next page

Table 6. LonWorks Network Variables - Outputs				
LonMarkName	SNVT Index	SNVT Type	SNVT Unit	Description
nvoSpaceCO2	42	SNVT_ppm		Zone CO2 level (PPM), local
nvoSpaceRHEff	43	SNVT_lev_percent		Zone relative humidity, effective
nvoSpaceRH	44	SNVT_lev_percent		Zone relative humidity, local
nvoEffSpaceDHSP	45	SNVT_lev_percent		Zone relative humidity set point
nvoDehumidifier	46	SNVT_switch		Dehumidification status
nvoRATemp	47	SNVT_temp_p	Deg_F	Return air temperature
nvoBldgStatPress	48	SNVT_press_p	Inch_H2O	Analog Input 2 (GP1 - VAV Bldg Static)
nvoDuctStatPress	49	SNVT_press_p	Inch_H2O	Analog Input 1 (GP1 - VAV Supply Static)
nvoExhFanStatus	50	SNVT_switch		Exhaust fan status
snvoNeuronByte1	51	SNVT_char_ascii		
snvoNeuronByte2	52	SNVT_char_ascii		
snvoNeuronByte3	53	SNVT_char_ascii		
snvoNeuronByte4	54	SNVT_char_ascii		
snvoNeuronByte5	55	SNVT_char_ascii		
snvoNeuronByte6	56	SNVT_char_ascii		

### Zone Sensor Setpoints

The IMC typically uses four setpoints and the zone temperature to operate the unit when a zone sensor is installed. Because the LonTalk network provides a single setpoint input, the IMC will use the zone temperature and ECTO 6.15 to determine the setpoint in the occupied mode.

During the unoccupied mode, the IMC will use the zone temperature and the difference between ECTO 6.05 and 6.03. See figure 8 for an example of setpoints when the IMC is operating in default mode.

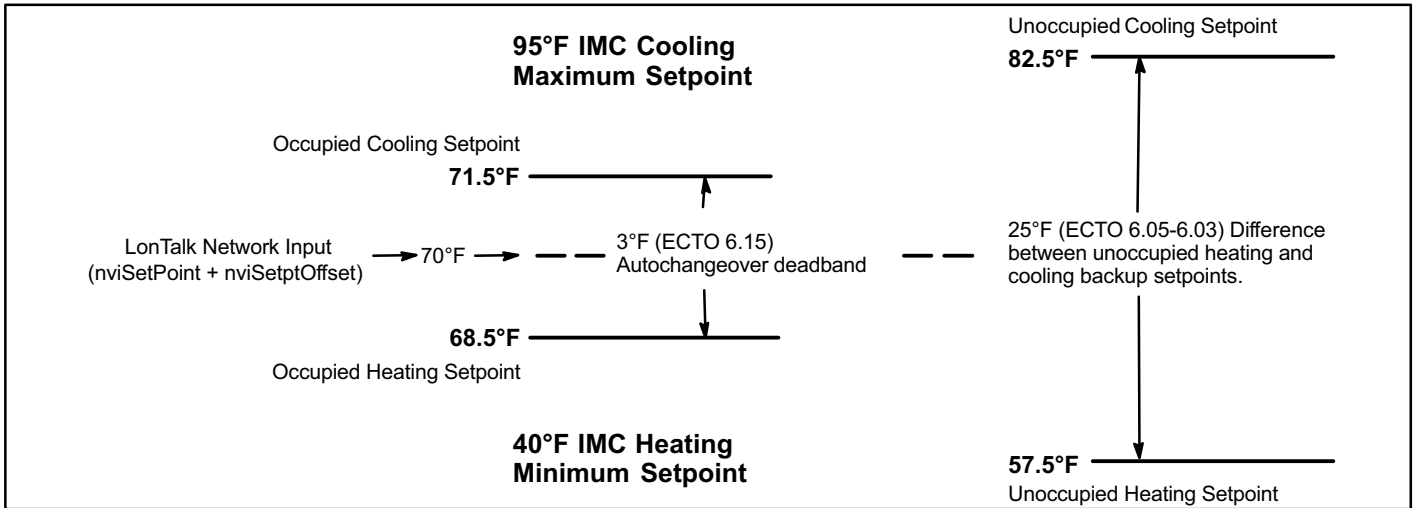

Figure 8. IMC Default Setpoint Example (Zone Sensor Installed)

**IMC Alarm Codes** See the IMC user guide for a list of alarm codes.



## Interpretation Of Datapoints

Variable Name: **nviApplicMode** (input: Application Mode)  
 SNVT Type: SNVT\_hvac\_mode  
 SNVT Index: 0  
 SNVT Units: -  
 Value = 0 - 255

Set the application mode input to Value.

The IMC controller is set locally during commissioning to operate in the remote room sensor control mode (with local or remote room sensor). The LonTalk module does not currently support remote thermostat operation.

Value	Mode	Description
0 \$00	AUTO	Heating or cooling. Default after reset.
1 \$01	HEAT	Heating only.
3 \$03	COOL	Cooling only.
6 \$06	OFF	Unit off.
9 \$09	FAN ONLY	No heating or cooling allowed.
255 \$FF	NUL	Same as AUTO.

AUTO is the default application mode input. When in a remote room sensor mode, AUTO allows the IMC control to generate heating and cooling demands based on room temperature and room temperature setpoint. Auxiliary functions such as dehumidification or emergency override (i.e. smoke mode) will still operate as needed. Also the blower and exhaust fan functions operate.

HEAT and COOL allow the servicing of only heating or cooling demands.

Application mode OFF is a unit-disable state, causing the controller to become idle, and clearing all outputs and timers. All outputs are kept off while application mode is OFF.

Application mode FAN ONLY disables heating and cooling operation. No effect on fan operation. Return to normal operation with AUTO, HEAT, or COOL.

AUTO is the defaults after reset.

Variable Name: **nviOAMinPos** (input: Outdoor Air Damper Minimum Position)  
 SNVT Type: SNVT\_lev\_percent  
 SNVT Index: 1  
 SNVT Units: -  
 Value = 0 - 255

0 -100: Set the minimum position of the outdoor air economizer damper; % open.  
 101 -255: Relinquish to local control. Min. damper position depends on the setting in IMC ECTO 5.24:

ECTO 5.24

=101: Min. damper position set by potentiometer on economizer control.

<101: Min. damper position set by ECTO 5.24.

The minimum damper position is only effective when the system is occupied and the main blower is running. Otherwise the damper remains closed.

Variable Name: **nviOccManCmd** (input: Occupancy Manual Override Control)  
 SNVT Type: SNVT\_occupancy  
 SNVT Index: 2  
 SNVT Units: -  
 Value = 0 - 255

0: space occupied  
 1: space unoccupied (IMC does not support; gives auto operation)  
 2: refresh space occupied timer defined at local controller  
 3-255: auto; clear timer and return to occupancy scheduler state

---

Variable Name: **nviOccSchedule** (input: Occupancy Scheduler Control)  
SNVT Type: SNVT\_tod\_event  
SNVT Index: 3  
SNVT Units: -  
Value = 0 - 255  
0: space occupied  
1-255: space unoccupied

---

Variable Name: **nviOccSensor** (input: Occupancy Sensor Input)  
SNVT Type: SNVT\_occupancy  
SNVT Index: 4  
SNVT Units: -  
Value = 0 - 255  
0: occupancy sensor indicates space occupied  
1: occupancy sensor indicates space unoccupied (IMC does not support; gives auto operation)  
2-255: auto; return to occupancy scheduler state  
The occupancy inputs are logically “OR”; if any one is “OCCUPIED” then the space is occupied, otherwise the space is “UNOCCUPIED”. No single input can force the space “UNOCCUPIED”.

---

Variable Name: **nviSpaceDehumSP** (input: Space Dehumidification Setpoint)  
SNVT Type: SNVT\_lev\_percent  
SNVT Index: 5  
SNVT Units: -  
Value = 0 - 100  
0-100: % relative humidity setpoint  
Dehumidification begins when the effective space relative humidity rises to this setpoint value.  
Dehumidification ends when the effective space relative humidity reaches falls below this setpoint value minus a dehumidification deadband that is typically 3%. The deadband value is set locally during commissioning.

---

Variable Name: **nviSetpoint** (input: Temperature Setpoint)  
SNVT Type: SNVT\_temp\_p  
SNVT Index: 6  
SNVT Units: Deg\_F  
Value = 36.25 – 100.00 degF, in 0.25 degF increments  
The single-point nviSetpoint (including offset; see below) is converted locally to occupied and unoccupied heating and cooling setpoints. The occupied and unoccupied heating and cooling setpoints are computed to be centered (if possible) on the effective single-point setpoint. This is done while preserving the occupied and unoccupied deadbands, as well as any local restrictions on minimum or maximum values.  
The occupied heat/cool auto-changeover deadband value is set locally during commissioning.  
The unoccupied heat/cool auto-changeover deadband value is set locally during commissioning by adjusting the backup unoccupied heating and cooling setpoints. The difference between these setpoints will be used as the unoccupied heat/cool auto-changeover deadband value.

---

Variable Name: **nviSetptOffset** (input: Temperature Setpoint Offset)  
SNVT Type: SNVT\_temp\_p  
SNVT Index: 7  
SNVT Units: Deg\_F  
Value = -32.00 – 31.75 degF, in 0.25 degF increments  
A signed value added to the Temperature Setpoint (abs) value to provide an effective temperature setpoint. See above regarding deadbands and limits.

---

---

Variable Name: **nviSpaceTemp** (input: Space Temperature)  
 SNVT Type: SNVT\_temp\_p  
 SNVT Index: 8  
 SNVT Units: Deg\_F  
 Value = 36.25 – 100.00 degF, in 0.25 degF increments

A network value for the space temperature. Heating and cooling demands are generated based on the nviSpaceTemp, and the nviSetpoint and nviSetptOffset values. See above.

When an IMC is commissioned for LonWorks gateway remote room sensor operation, it will wait for 5 minutes following start up to receive space temperature data. The IMC will remain in a no-run mode until data is received, or until the 5 minute period has expired.

If 5 minutes passes without data being received, then the IMC begins to use local data for the space temperature. If a local sensor is connected then it will be used. If not, then a failed-sensor error is recorded and the IMC will enter the backup mode of operation (set locally during commissioning).

It is recommended that network data be updated at intervals of no more than 2 minutes to be sure that a single missed-data event will not constitute a data update failure.

If data appears after a sensor failure is processed, it will be treated as an intermittent sensor. Normal operation will resume. If the IMC is in a backup mode, then it will reset before resuming.

---

Variable Name: **nviEmergOverride** (input: Emergency Override)  
 SNVT Type: SNVT\_hvac\_emerg  
 SNVT Index: 9  
 SNVT Units: -  
 Value = 0 - 255

Set the emergency mode defined by Value, decoded as:

Value	Mode	Supply Fan	Exhaust Fan	Outdoor Damper
0	NORMAL	auto	auto	auto
1	PRESSURIZE	on	off	open
2	DEPRESSURIZE	off	on (speed)	closed
3	PURGE	on	on (speed)	open
4	SHUTDOWN	off	off	closed
5	FIRE			
6	DEPRESSURIZE	off	on (pressure)	closed
7	PURGE	on	on (pressure)	open
>7	NUL (normal)	auto	auto	auto

auto –normal operation

(speed) –exhaust fan runs at speed pre-selected at equipment

(pressure) –exhaust fan runs to maintain building press setpoint; local or remote

Mode 5, FIRE, is a locally defined operation (set at commissioning). For units without VFD exhaust fans, modes 6-7 are the same as 2-3.

NviEmergOverride input takes precedence over local smoke input.

---

Variable Name: **nviComprEnable** (input: Compressor Enable)  
 SNVT Type: SNVT\_switch  
 SNVT Index: 10  
 SNVT Units: -  
 Value = 0 - 255

0: output disabled  
 1-100: output limited to 1 – 100% of maximum  
 101-255: maximum output permitted

The following table shows the Value where the indicated compressor stage is disabled, for equipment having the indicated maximum number of compressor stages:

Maximum Stages	Stage Disabled When Value < x			
	1	2	3	4
1	Value < 50			
2	Value < 33	Value < 66		
3	Value < 25	Value < 50	Value < 75	
4	Value < 20	Value < 40	Value < 60	Value < 80

Free cooling using an economizer with outdoor air is not considered a stage. Only compressors are considered to be stages. Disabled stages are re-enabled at the above values plus 3% hysteresis.

---

Variable Name: **nviPriHeatEnable** (input: Primary Heat Enable)  
 SNVT Type: SNVT\_switch  
 SNVT Index: 11  
 SNVT Units: -  
 Value = 0 - 255

0: output disabled  
 1-100: output limited to 1 – 100% of maximum  
 101-255: maximum output permitted

The table shown above for nviComprEnable can also be applied here to the nviPriHeatEnable. It shows the Value where the indicated primary heating stage is disabled, for equipment having the indicated maximum number of primary heating stages. In heat pump systems during heating operation, the lower value of nviComprEnable and nviPriHeatEnable is used to establish the compressors that can run.

---

Variable Name: **nviAuxHeatEnable** (input: Auxiliary Heat Enable)  
 SNVT Type: SNVT\_switch  
 SNVT Index: 12  
 SNVT Units: -  
 Value = 0 - 255

0: output disabled  
 1-100: output limited to 1 – 100% of maximum  
 101-255: maximum output permitted

The table shown above for nviComprEnable can also be applied here to the nviAuxHeatEnable. It shows the Value where the indicated auxiliary heating stage is disabled, for equipment having the indicated maximum number of auxiliary heating stages.

The nviAuxHeatEnable is only used in heat pump systems.

---

Variable Name: **nviDuctStaticSP** (input: Duct Static Setpoint)  
 SNVT Type: SNVT\_press\_f  
 SNVT Index: 57  
 SNVT Units: Inch\_H2O  
 Value = 0.0 - 5.0 inWC

The setpoint for control of duct static pressure, in inches of water column. The main blower speed or bypass damper setting is varied to maintain this value. The setpoint can be selected from the range of 0.0 to 5.0 inches of water column.

---

Variable Name: **nviBldgStaticSP** (input: Building Static Setpoint)  
SNVT Type: SNVT\_press\_f  
SNVT Index: 58  
SNVT Units: Inch\_H2O  
Value = -0.5 - 0.5 inWC

The setpoint for control of building static pressure, in inches of water column. The exhaust blower is cycled or, if a VFD is used, its speed is varied to maintain this value. The setpoint can be selected from the range of -0.5 to +0.5 inches of water column.

---

Variable Name: **nviDACISP** (input: Discharge Air Cooling Setpoint)  
SNVT Type: SNVT\_temp\_p  
SNVT Index: 59  
SNVT Units: Deg\_F  
Value = 40 - 80 degF, and -9 degF

The setpoint for control of discharge (or supply) air temperature during cooling. When the controller is in the correct mode of operation, sending this setpoint will cause cooling components to cycle, or vary their output, in order to maintain this temperature in the leaving air stream. The setpoint can be selected from the range of 40 to 80 degrees Fahrenheit. Selecting a value of -9 degF causes the control to revert to the use of its locally programmed setpoint.

---

Variable Name: **nviDAHtSP** (input: Discharge Air Heating Setpoint)  
SNVT Type: SNVT\_temp\_p  
SNVT Index: 60  
SNVT Units: Deg\_F  
Value = 80 - 140 degF, and -9 degF

The setpoint for control of discharge (or supply) air temperature during heating. When the controller is in the correct mode of operation, sending this setpoint will cause heating components to cycle, or vary their output, in order to maintain this temperature in the leaving air stream. The setpoint can be selected from the range of 80 to 140 degrees Fahrenheit. Selecting a value of -9 degF causes the control to revert to the use of its locally programmed setpoint.

---

Variable Name: **nviSupFanCap** (input: Supply Fan Capacity Input)  
SNVT Type: SNVT\_lev\_cont\_f  
SNVT Index: 61  
SNVT Units: -  
Value = 0 - 255

0 - 100: Set the supply fan capacity as a % of maximum speed.  
101 - 255: Relinquish to local control. Supply fan capacity depends on IMC ECTO values.  
Supply fan capacity is only effective when the main blower is running.

---

Variable Name: **nviExhFanCap** (input: Exhaust Fan Capacity Input)  
SNVT Type: SNVT\_lev\_cont\_f  
SNVT Index: 62  
SNVT Units: -  
Value = 0 - 255

0 - 100: Set the exhaust fan capacity as a % of maximum speed.  
101 - 255: Relinquish to local control. Exhaust fan capacity depends on IMC ECTO values.  
Exhaust fan capacity is only effective when the exhaust fan is running.

---

Variable Name: nviEconEnable (Input: Economizer enable)  
SNVT Type: SNVT\_switch  
SVNT Index: 63  
SNVT Units: -  
Value = 0-255

0: Economizer disable  
1: Economizer enable  
>1: Economizer auto; relinquish to local control

LonTalk control of the economizer requires the economizer board A56 (EM1) to have switches selected to TMP temperature mode. See the IMC manual for additional settings.

---

Variable Name: **snvoCommStatus** (output: Communication Status)  
SNVT Type: SNVT\_count  
SNVT Index: 13  
SNVT Units: -  
Value = 0 - 1

0: Lennox IMC is not communicating.  
1: Lennox IMC is communicating.

---

Variable Name: **snvoIMCVersion** (output: IMC Firmware Version)  
SNVT Type: SNVT\_str\_asc  
SNVT Index: 14  
SNVT Units: -  
Value = 0, 46, 48 - 57

0: end of string  
46: "."  
48: "0"  
...  
57: "9"

The version number of the IMC firmware is found in a nul-terminated ASCII string, most-significant-character first. Maximum length is 8 chars, including nul.

---

Variable Name: **snvoUnitID** (output: Rooftop Unit Type)  
SNVT Type: SNVT\_count  
SNVT Index: 15  
SNVT Units: -  
Value = 0 - 255

48-63: gas heat, electric cool  
64-79: electric heat, electric cool  
80-95: electric heat pump, with or without electric resistive heat  
These are the currently defined IMC unit types.

---

Variable Name:        **nvoUnitStatus**           (output: Unit Operating Status)  
SNVT Type:            SNVT\_hvac\_status  
SNVT Index:           16  
SNVT Units:           -

Value = 0 - 255

- 1 – HVAC heat.
- 2 – HVAC morning warmup.
- 3 – HVAC cool.
- 5 – HVAC pre-cool.
- 6 – HVAC off.
- 7 – HVAC test.
- 8 – HVAC emergency heat.
- 9 – HVAC fan only.
- 12 – HVAC max heat.
- 14 – HVAC dehumidification.
- 129 – HVAC fresh air heating.
- 131 – HVAC fresh air cooling.
- 145 – HVAC defrost compressor 1.
- 161 – HVAC defrost compressor 2.
- 177 – HVAC defrost compressor 1 & 2.

These are the currently defined IMC unit status.

---

Variable Name:        **nvoSpaceTemp**           (output: Space Temperature)  
SNVT Type:            SNVT\_temp\_p  
SNVT Index:           17  
SNVT Units:           Deg\_F

Value = 63.75 – 100.00 degF, in 0.25 degF increments

Space temperature from local IMC sensor, or from “Space Temperature Input”.

This is the actual value being used by the IMC. Its source is either a locally wired temperature sensor (see nvoLocalSpace-Tmp) or the network input (see nviSpaceTemp)

---

Variable Name:        **nvoDischAirTemp**       (output: Discharge Air Temperature)  
SNVT Type:            SNVT\_temp\_p  
SNVT Index:           18  
SNVT Units:           Deg\_F

Value = -8.7 – 164.4 degF, in 0.7 degF increments

Discharge air temperature measurement from IMC sensor.

---

Variable Name:        **nvoEffectOccup**       (output: Effective Occupancy)  
SNVT Type:            SNVT\_occupancy  
SNVT Index:           19  
SNVT Units:           -

Value = 0 - 2

- 0:           space occupied
- 1:           space unoccupied
- 2:           space occupied (timed override)

The occupancy override timer is established locally for each controller during system commissioning.

The nvoEffectOccup depends on the nviOccSchedule, the nviOccManCmd, and the nviOccSensor. The nvoEffectOccup is occupied if any of these inputs are in the occupied state. Otherwise nvoEffectOccup is unoccupied.

The local IMC occupied input is ignored when a LonTalk module is used.

---

Variable Name: **nvoLocalOATemp** (output: Local Outdoor Air Temperature)  
SNVT Type: SNVT\_temp\_p  
SNVT Index: 20  
SNVT Units: Deg\_F  
Value = -30.6 – 131.6 degF, in 0.6 degF increments  
Outdoor air temperature measurement from IMC sensor.

---

Variable Name: **nvoLocalSpaceTmp** (output: Local Space Temperature)  
SNVT Type: SNVT\_temp\_p  
SNVT Index: 21  
SNVT Units: Deg\_F  
Value = 63.75 – 100.00 degF, in 0.25 degF increments  
Space temperature from IMC sensor.

---

Variable Name: **nvoOADamper** (output: Outdoor Air Damper Position)  
SNVT Type: SNVT\_lev\_percent  
SNVT Index: 22  
SNVT Units: -  
Value = 0 – 100, 255  
0 - 100: Outdoor air damper position; percent-open.  
255: No damper.

---

Variable Name: **nvoHeatPrimary** (output: Primary Heating Capacity)  
SNVT Type: SNVT\_lev\_percent  
SNVT Index: 23  
SNVT Units: -  
Value = 0 – 100  
0 - 100: Current level of the primary heating capacity.  
This is based on the number of gas stages operating in a gas/electric unit, or compressors operating in a heat pump, or electric resistance stages operating in an electric/electric unit.

---

Variable Name: **nvoHeatSecondary** (output: Secondary Heating Capacity)  
SNVT Type: SNVT\_lev\_percent  
SNVT Index: 24  
SNVT Units: -  
Value = 0 – 100  
0 - 100 Current level of the secondary heating capacity.  
This is auxiliary (electric resistance “strip”) heat in a heat pump. Whether it is on in addition to the primary heat (compressor), or as emergency heat while the compressor is locked-out.

---

Variable Name: **nvoCoolPrimary** (output: Primary Cooling Capacity)  
SNVT Type: SNVT\_lev\_percent  
SNVT Index: 25  
SNVT Units: -  
Value = 0 – 100  
0 - 100: Current level of the primary cooling capacity.  
This is based on the number of compressors operating.  
There is no secondary cooling.

---



---

Variable Name: **nvoEconEnabled** (output: Economizer Enabled)  
SNVT Type: SNVT\_switch  
SNVT Index: 26  
SNVT Units: -  
Value = 0 – 1, 255

0: Economizer is disabled.  
1: Economizer is enabled (outdoor air is suitable for free cooling).  
255: No economizer.

The enabled state only indicates that the IMC has determined that the outdoor air is suitable for free cooling. The unit is actually executing free cooling operation if nvoEconEnabled is 1, and nvoUnitStatus is 3, 5, or 131.

---

Variable Name: **nvoSupFanStatus** (output: Supply Fan Status)  
SNVT Type: SNVT\_switch  
SNVT Index: 27  
SNVT Units: -  
Value = 0 – 100

0 Supply fan off.  
1 Supply fan on (single-speed fan).  
2 - 100 Supply fan on (variable-speed fan; percent of full speed).

---

Variable Name: **nvoEffectSetpt** (output: Effective Space Temp Setpoint)  
SNVT Type: SNVT\_temp\_p  
SNVT Index: 28  
SNVT Units: Deg\_F  
Value = 40.0 – 95.0 degF, in 0.25 degF increments

The effective space temperature setpoint, which depends on:

current nviSetpoint,  
current nviSetptOffset,  
current nvoEffectOccup,  
most recent heating or cooling demand indicated by nvoUnitStatus,  
any local setpoint adjustment,  
and heating and cooling deadbands and differentials set at system commissioning.

---

Variable Name: **snvoCurrentError** (output: Current Error Displayed At IMC)  
SNVT Type: SNVT\_count  
SNVT Index: 29  
SNVT Units: -  
Value = 0 - 255

This is the code for the currently occurring alarm condition, if any. If no alarm is currently in progress, then the Value is 0. If the Value is not zero, then “Current Error” and “Most Recent Error 1” (see below) will be equal.

Refer to the IMC User’s Guide for alarm code descriptions.

---

Variable Name: **snvoErrorPointer** (output: Error Index)  
SNVT Type: SNVT\_count  
SNVT Index: 30  
SNVT Units: -  
Value = 0 - 83

This value points to the next available alarm code location. It runs from 0 to 83, and then rolls-over to 0. Tracking this value and using the ten-most-recent-error-codes (see below) allows an application to determine when new errors are logged by the IMC, what those errors are, and if any errors have been missed due to network delays or for any other reason.

---

Variable Name: **snvoMostRecErr1,** (output: Ten Most Recent Errors)  
**snvoMostRecErr2,**  
...  
**snvoMostRecErr10**

SNVT Type: SNVT\_count  
SNVT Index: 31, 32, ..., 40  
SNVT Units: -  
Value = 1 - 255

These are the ten most recently occurring diagnostic codes; snvoMostRecErr1 is the most recent.

The IMC does not time-stamp error codes. This must be done by the master controller.

This is a first-in first-out buffer. Error codes are stored as they occur, and no filtering is done with respect to duplication or error code severity or priority.

When another error code is logged at snvoMostRecErr1, the value in snvoMostRecErr10 is lost, being replaced by snvoMostRecErr9.

Refer to the IMC User's Guide for alarm code descriptions.

---

Variable Name: **snvoSpaceCO2Eff** (output: Effective Space CO2)

SNVT Type: SNVT\_ppm  
SNVT Index: 41  
SNVT Units: -  
Value = 0 - 2000

0 - 6: no sensor  
7 - 1992: valid CO<sub>2</sub> measurement  
1993 - 2000: sensor error

This is the actual value being used by the IMC, and is the value measured at the IMC.

---

Variable Name: **nvoSpaceCO2** (output: Local Space CO2 Sensor)

SNVT Type: SNVT\_ppm  
SNVT Index: 42  
SNVT Units: -  
Value = 0 - 2000

0 - 6: no sensor  
7 - 1992: valid CO<sub>2</sub> measurement  
1993 - 2000: sensor error

This is the actual value being used by the IMC, and is the value measured at the IMC.

---

Variable Name: **nvoSpaceRHEff** (output: Effective Space Rel. Humidity)

SNVT Type: SNVT\_lev\_percent  
SNVT Index: 43  
SNVT Units: -  
Value = 0 - 100

0: no sensor  
1 - 99: valid relative humidity measurement  
100: sensor error

This is the actual value being used by the IMC, and is the value measured at the IMC.

---

Variable Name: **nvoSpaceRH** (output: Local Space Rel. Humidity Sensor)  
SNVT Type: SNVT\_lev\_percent  
SNVT Index: 44  
SNVT Units: -  
Value = 0 - 100  
0: no sensor  
1 - 99: valid relative humidity measurement  
100: sensor error  
This is the actual value being used by the IMC, and is the value measured at the IMC.

---

Variable Name: **nvoEffSpaceDHSP** (output: Effective Dehumidification Setpoint)  
SNVT Type: SNVT\_lev\_percent  
SNVT Index: 45  
SNVT Units: -  
Value = 0 - 100  
Relative humidity setpoint for dehumidification operation.  
Deadband is set locally during commissioning.

---

Variable Name: **nvoDehumidifier** (output: Dehumidification Status)  
SNVT Type: SNVT\_switch  
SNVT Index: 46  
SNVT Units: -  
Value = 0 – 2  
0: No dehumidification installed.  
1: Dehumidification installed but not running.  
2: Dehumidification installed and running.

---

Variable Name: **nvoRATemp** (output: Return Air Temperature)  
SNVT Type: SNVT\_temp\_p  
SNVT Index: 47  
SNVT Units: Deg\_F  
Value = -8.7 – 164.4 degF, in 0.7 degF increments  
Unit return air temperature measurement from IMC sensor.

---

Variable Name: **nvoBldgStatPress** (output: Building Static Pressure)  
SNVT Type: SNVT\_press\_p  
SNVT Index: 48  
SNVT Units: Inch\_H2O  
Value = -0.500 – 0.500 inWC, in 0.004 inWC increments  
Building (space) static pressure measurement from IMC sensor.

---

Variable Name: **nvoDuctStatPress** (output: Supply Duct Static Pressure)  
SNVT Type: SNVT\_press\_p  
SNVT Index: 49  
SNVT Units: Inch\_H2O  
Value = 0.00 – 5.00 inWC, in 0.02 inWC increments  
Duct (supply) static pressure measurement from IMC sensor.

---

Variable Name: **nvoExhFanStatus** (output: Exhaust Fan Status)  
SNVT Type: SNVT\_switch  
SNVT Index: 50  
SNVT Units: -  
Value = 0 – 100  
0: Exhaust fan off.  
1: Exhaust fan on (single-speed fan).  
2 - 100: Exhaust fan on (variable-speed fan; percent of full speed).

---

Variable Name: **snvoNeuronByte1,** (output: Six Byte Neuron ID)  
**SnvoNeuronByte2,**  
...  
**SnvoNeuronByte6**  
SNVT Type: SNVT\_char\_ascii  
SNVT Index: 51, 52, ..., 56  
SNVT Units: -  
Value = 0 – 255  
The 6-byte Neuron ID for the Echelon Neuron IC in the LonTalk module.  
snvoNeuronByte1 is the most significant byte, and snvoNeuronByte6 is the least significant byte.

---