

ICOMFORT®-ENABLED SL280UHNV SERIES UNITS

SL280UHNVseries units are 80% efficiency gas furnaces used for upflow or horizontal applications only, manufactured with Lennox Duralok heat exchangers formed of aluminized steel. SL280UHNV units are available in heating capacities of 40,000 to 100,000 Btuh and cooling applications up to 5 tons. Refer to Engineering Handbook for proper sizing.

Units are approved for installations up 4500 ft. SL280UHNV model units are equipped with the iComfort® enabled SureLight® two-stage variable speed integrated control. SL280UHNV unit meets the California Nitrogen Oxides (NOx) Standards and California Seasonal Efficiency requirements. All units use a redundant gas valve to assure safety shut-off as required by C.S.A.

All specifications in this manual are subject to change. Procedures outlined in this manual are presented as a recommendation only and do not supersede or replace local or state codes. In the absence of local or state codes, the guidelines and procedures outlined in this manual (except where noted) are recommendations only and do not constitute code.



Contents

I-Unit Components.....4
Blower Data 16
II-Placement and Installation31
III-Start-Up.....31
IV-Heating System Service Checks.....32
V-Typical Operating Characteristics 34
VI-Maintenance35
VII- Wiring and Sequence of Operation.....38
VIII- Field Wiring With Conventional Thermostat.....42
IX- Program Unit Capacity Size Modes46
X- Troubleshooting47

⚠ WARNING
Improper installation, adjustment, alteration, service or maintenance can cause property damage, personal injury or loss of life. Installation and service must be performed by a licensed professional HVAC installer or equivalent, service agency, or the gas supplier.

⚠ CAUTION
As with any mechanical equipment, contact with sharp sheet metal edges can result in personal injury. Take care while handling this equipment and wear gloves and protective clothing.

SPECIFICATIONS

Gas	Model No.	SL280UH060NV36A	SL280UH080NV48B
Heating Performance	¹ AFUE	80%	80%
High Fire	Input - Btuh	60,000	80,000
	Output - Btuh	48,000	64,000
	Temperature rise range - °F	30 - 60	30 - 60
	Gas Manifold Pressure (in. w.g.) Natural Gas Only	3.4	3.4
Low Fire	Input - Btuh	39,000	52,000
	Output - Btuh	31,000	41,000
	Temperature rise range - °F	20 - 50	20 - 50
	Gas Manifold Pressure (in. w.g.) Natural Gas Only	1.5	1.5
High static - in. w.g.	Heating	0.8	0.8
	Cooling	1.0	1.0
Connections in.	Flue connection - in. round	4	4
	Gas pipe size IPS	1/2	1/2
Indoor Blower	Wheel nominal diameter x width - in.	10 X 8	11-1/2 X 9
	Motor output - hp	1/2	1.0
	Tons of add-on cooling	2 - 3	2.5 - 4
	Air Volume Range - cfm	606 - 1345	679 - 2002
Electrical Data	Voltage	120 volts - 60 hertz - 1 phase	
	Blower motor full load amps	7.7	12.8
	Maximum overcurrent protection	15	20
Shipping Data	lbs. - 1 package	112	138

NOTE - Filters and provisions for mounting are not furnished and must be field provided.

¹ Annual Fuel Utilization Efficiency based on DOE test procedures and according to FTC labeling regulations. Isolated combustion system rating for non-weatherized furnaces.

SPECIFICATIONS

Gas	Model No.	SL280UH080NV60C	SL280UH100NV60C
Heating Performance	¹ AFUE	80%	80%
High Fire	Input - Btuh	80,000	100,000
	Output - Btuh	64,000	80,000
	Temperature rise range - °F	30 - 60	30 - 60
	Gas Manifold Pressure (in. w.g.) Natural Gas Only	3.4	3.4
Low Fire	Input - Btuh	52,000	65,000
	Output - Btuh	41,000	52,000
	Temperature rise range - °F	20 - 50	25 - 50
	Gas Manifold Pressure (in. w.g.) Natural Gas Only	1.5	1.5
High static - in. w.g.	Heating	0.8	0.8
	Cooling	1.0	1.0
Connections in.	Flue connection - in. round	4	4
	Gas pipe size IPS	1/2	1/2
Indoor Blower	Wheel nominal diameter x width - in.	11-1/2 X 10	11-1/2 X 10
	Motor output - hp	1.0	1.0
	Tons of add-on cooling	3 - 5	3 - 5
	Air Volume Range - cfm	826 - 2305	812 - 2125
Electrical Data	Voltage	120 volts - 60 hertz - 1 phase	
	Blower motor full load amps	12.8	12.8
	Maximum overcurrent protection	20	20
Shipping Data	lbs. - 1 package	157	161

NOTE - Filters and provisions for mounting are not furnished and must be field provided.

¹ Annual Fuel Utilization Efficiency based on DOE test procedures and according to FTC labeling regulations. Isolated combustion system rating for non-weatherized furnaces.

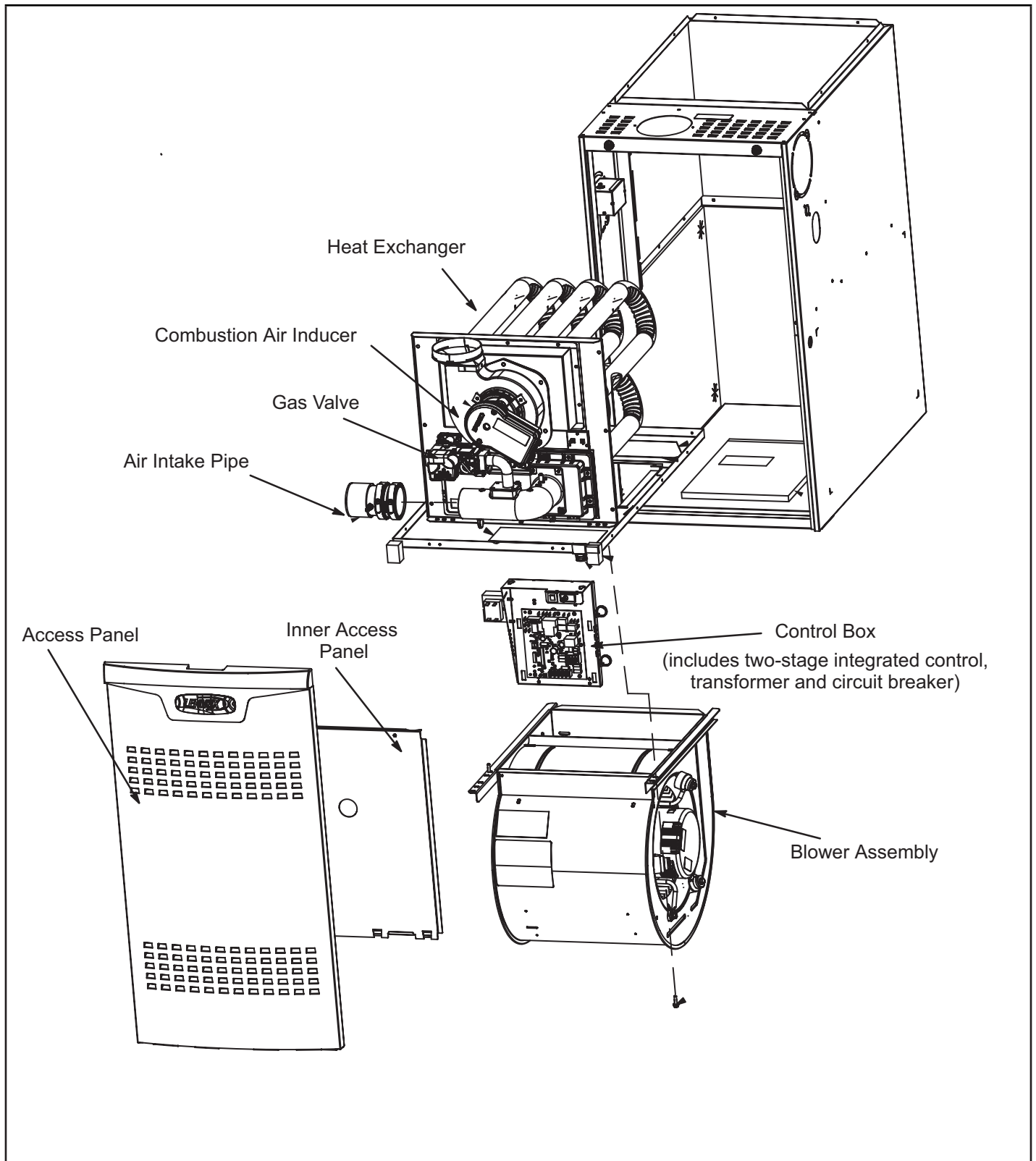

FIGURE 1

I-Unit Components

SL280UHNV unit components are shown in Figure 1. The gas valve, combustion air inducer and burners can be accessed by removing the access panel. Electrical components are in the control box (Figure 2) found in the blower section.

SL280UHNV units are factory equipped with a bottom return air panel in place. The panel is designed to be field removed as required for bottom air return. Markings are provided for side return air and may be cut out in the field.

ELECTROSTATIC DISCHARGE (ESD)

Precautions and Procedures

⚠ CAUTION

Electrostatic discharge can affect electronic components. Take precautions during furnace installation and service to protect the furnace's electronic controls. Precautions will help to avoid control exposure to electrostatic discharge by putting the furnace, the control and the technician at the same electrostatic potential. Neutralize electrostatic charge by touching hand and all tools on an unpainted unit surface, such as the gas valve or blower deck, before performing any service procedure.

A- Control Box

1. Control Transformer (T1)

A transformer located in the control box provides power to the low voltage section of the unit. Transformers on all models are rated 40VA with a 120V primary and a 24V secondary.

2. Door Interlock Switch (S51)

A door interlock switch rated 14A at 125VAC is wired in series with line voltage. When the inner blower access panel is removed the unit will shut down.

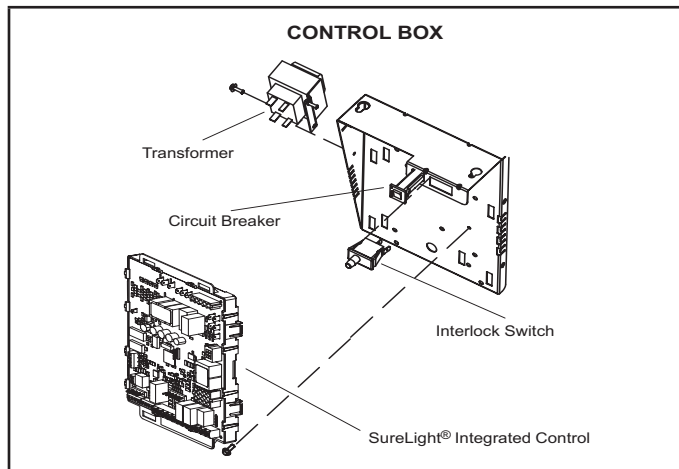

FIGURE 2

3. Circuit Breaker (CB8)

A 24V circuit breaker is also located in the control box. The switch provides overcurrent protection to the transformer (T1). The breaker is rated 3A at 32V. If the current exceeds this limit the breaker will trip and all unit operation will shutdown. The breaker can be manually reset by pressing the button on the face. See Figure 3

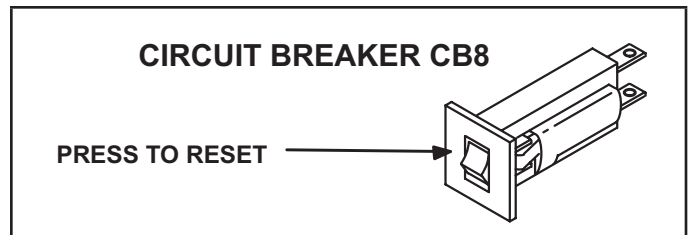

FIGURE 3

⚠ WARNING



Shock hazard. Disconnect power before servicing. Integrated control is not field repairable. If control is inoperable, simply replace entire control. Can cause injury or death. Unsafe operation will result if repair is attempted.

4. Integrated Control (A92)

Units are equipped with the icomfort enabled SureLight® two-stage, variable speed integrated control. This control is used with the icomfort Wi-Fi® thermostat as part of a communicating comfort system. The control can also operate with a non-communicating conventional single or two-stage thermostat. The system consists of a ignition / blower control (Figure 4 and Figure 5) with control pin designations in Table 1, Table 2 and Table 3 and ignitor (Figure 13). The control and ignitor work in combination to ensure furnace ignition and ignitor durability. The control provides gas ignition, safety checks and indoor blower control with two-stage gas heating.

The furnace combustion air inducer, gas valve and indoor blower are controlled in response to various system inputs such as thermostat signal, pressure and limit switch signal and flame signal. The control features a seven-segment LED display, indicating furnace status (including indoor blower) and error codes. The LED flashes in single digits. For example using Table 5 under LIMIT CODE, an "E" followed by "2" followed by "5" followed by "0", the limit switch circuit is open. The control also has two unpowered (dry) 1/4" contacts for a humidifier and a 120 volt accessory terminal. Both rated at (1) one amp each.

Electronic Ignition

At the beginning of the heat cycle the integrated control monitors the first stage and second stage combustion air inducer prove switch. The control will not begin the heating cycle if the first stage prove switch is closed (by-passed). Likewise the integrated control will not begin the second stage heating cycle if the second stage prove switch is closed, and will remain in first stage heat. However, if the second stage prove switch closes during the first stage heat pre-purge, the control will allow second stage heat.

Once the first stage prove switch is determined to be open, the combustion air inducer is energized on low (first stage) heat speed. When the differential in the prove switch is great enough, the prove switch closes and a 15-second pre-purge begins.

NOTE - During abnormal conditions such as low supply voltage or low outdoor temperatures and the low fire pressure switch does not close, the combustion air inducer will switch to high fire. After a 15 second pre-purge the high fire pressure switch will close and the unit will begin operation on high fire. After 10 to 20 seconds of high fire operation the unit will switch to low fire.

After the 15-second pre-purge period, the SureLight ignitor warms up for 20 seconds after which the gas valve opens for a 4-second trial for ignition. The ignitor energizes during the trial until flame is sensed. If ignition is not proved during the 4-second period, the control will try four more times with an inter purge and warm-up time between trials of 35 seconds. After a total of five trials for ignition (including the initial trial), the control goes into Watchguard-Flame Failure mode. After a 60-minute reset period, the control will begin the ignition sequence again.

Two Stage Operation / Thermostat Selection DIP Switch

The control can be utilized in two modes: SINGLE-STAGE thermostat or TWO-STAGE thermostat. The thermostat selection is made using a DIP switch and must be positioned for the particular application. DIP switch 1, labeled T^hSTAT HEAT STAGE is factory-set in the OFF position for use with a two-stage thermostat. Move the DIP switch to ON for use with a single stage thermostat.

While in the single-stage thermostat mode, the burners will always fire on first-stage heat. The combustion air inducer will operate on low speed and indoor blower will operate on low heat speed. The unit will switch to second stage heat after a “recognition period”. DIP switch 2, labeled SECOND STAGE DELAY, is factory set in the OFF position for a 7 minute recognition period. The switch can be moved to the ON position for a 12 minute recognition period, after which time the unit will switch to secondstage heat.

While in the two-stage thermostat mode (two DIP switch setting) the burners will fire on first-stage heat. The combustion air inducer will operate on low speed and indoor blower will operate on low heat speed. The unit will switch to second-stage heat on call from the indoor thermostat. If there is a simultaneous call for first and second stage heat, the unit will fire an first stage heat and switch to second stage heat after 30 seconds of operation. See Sequence of Operation flow charts in the back of this manual for more detail.

TABLE 1

SureLight® Control 5 Pin Terminal Designation	
PIN#	Function
1	Ignitor
2	Combustion Air Inducer High Speed
3	Combustion Air Inducer Low Speed
4	Combustion Air Inducer Neutral
5	Ignitor Neutral

TABLE 2

SureLight® Control 12 Pin Terminal Designation	
PIN#	Function
1	Gas Valve High Fire
2	Second Stage Prove Switch
3	Rollout In
4	Ground
5	24V Hot
6	Primary Limit In
7	Gas Valve Low Stage
8	Gas Valve Common
9	24V Neutral
10	Ground
11	Rollout Switch Out
12	1st Stage Prove Switch

TABLE 3

SureLight® Control 6 Pin Terminal Designation	
PIN#	Function
1	Data Input From Motor
2	Common
3	Not Used
4	Data Output To Motor
5	5 Volt Bias Supply
6	Not Used

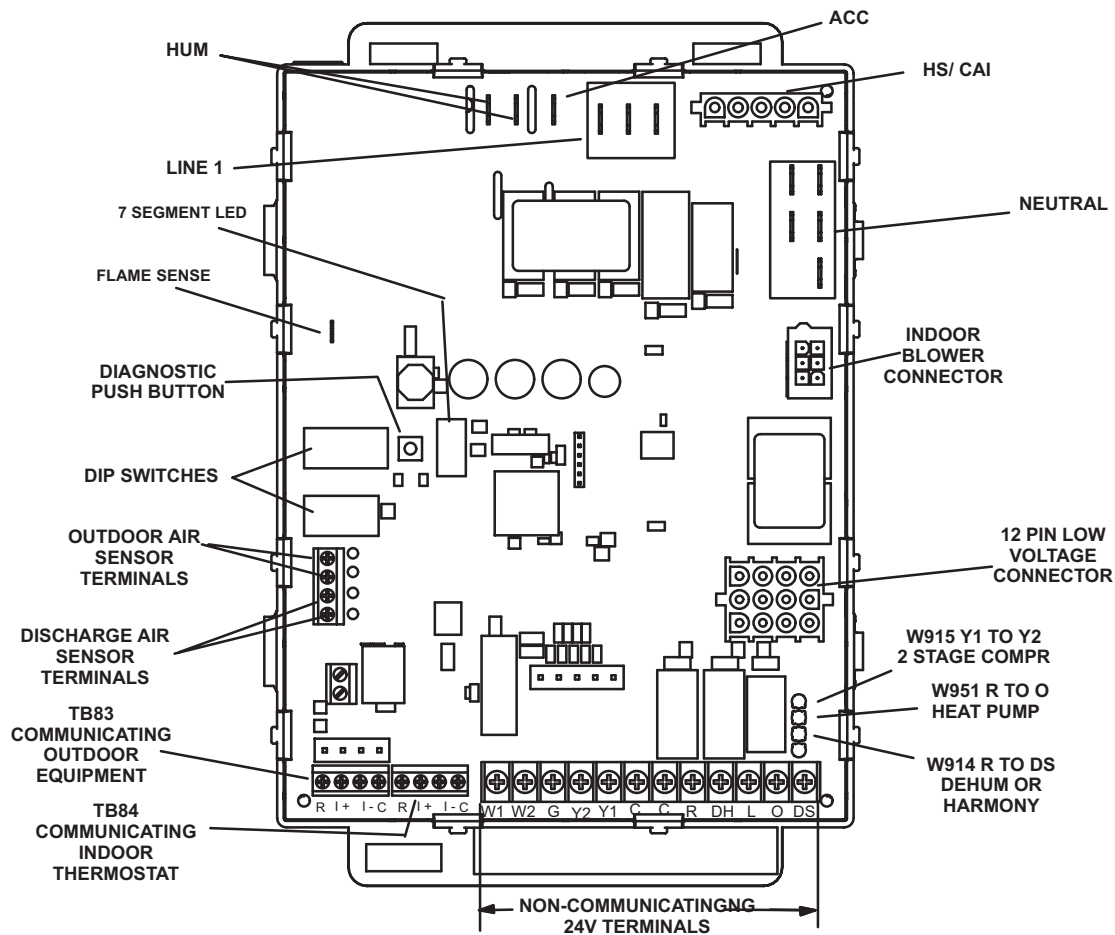

RS-BUS LINK (TB82, future use)

I+ = DATA HIGH CONNECTION
 I- = DATA LOW CONNECTION

RS-BUS OUTDOOR (TB83)

R = 24VAC
 I+ = DATA HIGH CONNECTION
 I- = DATA LOW CONNECTION
 C = 24VAXC COMMON

RS-BUS INDOOR (TB84)

R = 24VAC
 I+ = DATA HIGH CONNECTION
 I- = DATA LOW CONNECTION
 C = 24VAXC COMMON

1/4" QUICK CONNECT TERMINALS

HUM = UNPOWERED NORMALLY OPEN (DRY) CONTACTS
 XMFR = 120 VAC OUTPUT TO TRANSFORMER
 LI = 120 VAC INPUT TO CONTROL
 ACC = 120 VAC OUTPUT TO OPTIONAL ACCESSORY
 NEUTRALS = 120 VAC NEUTRAL

THERMOSTAT CONNECTIONS (TB1)

DS = DEHUMIDIFICATION SIGNAL
 W2 = HEAT DEMAND FROM 2ND STAGE T/STAT
 W1 = HEAT DEMAND FROM 1ST STAGE T/STAT
 R = CLASS 2 VOLTAGE TO THERMOSTAT
 G = MANUAL FAN FROM T'STAT
 C = THERMOSTAT SIGNAL GROUND CONNECTED TO TRANSFORMER GRD (TR) & CHASIS GROUND (GRD)
 Y1 = THERMOSTAT 1ST STAGE COOL SIGNAL
 Y2 = THERMOSTAT 2ND STAGE COOL SIGNAL
 O = THERMOSTAT SIGNAL TO HEAT PUMP REVERSING VALVE
 DH = DEHUMIDIFICATION OUTPUT COMMUNICATING THERMOSTAT ONLY
 L = USE ONLY WITH A COMMUNICATING THERMOSTAT AND A NON-COMMUNICATING OUTDOOR UNIT

FIGURE 4

INTEGRATED CONTROL CONFIGURATION GUIDE

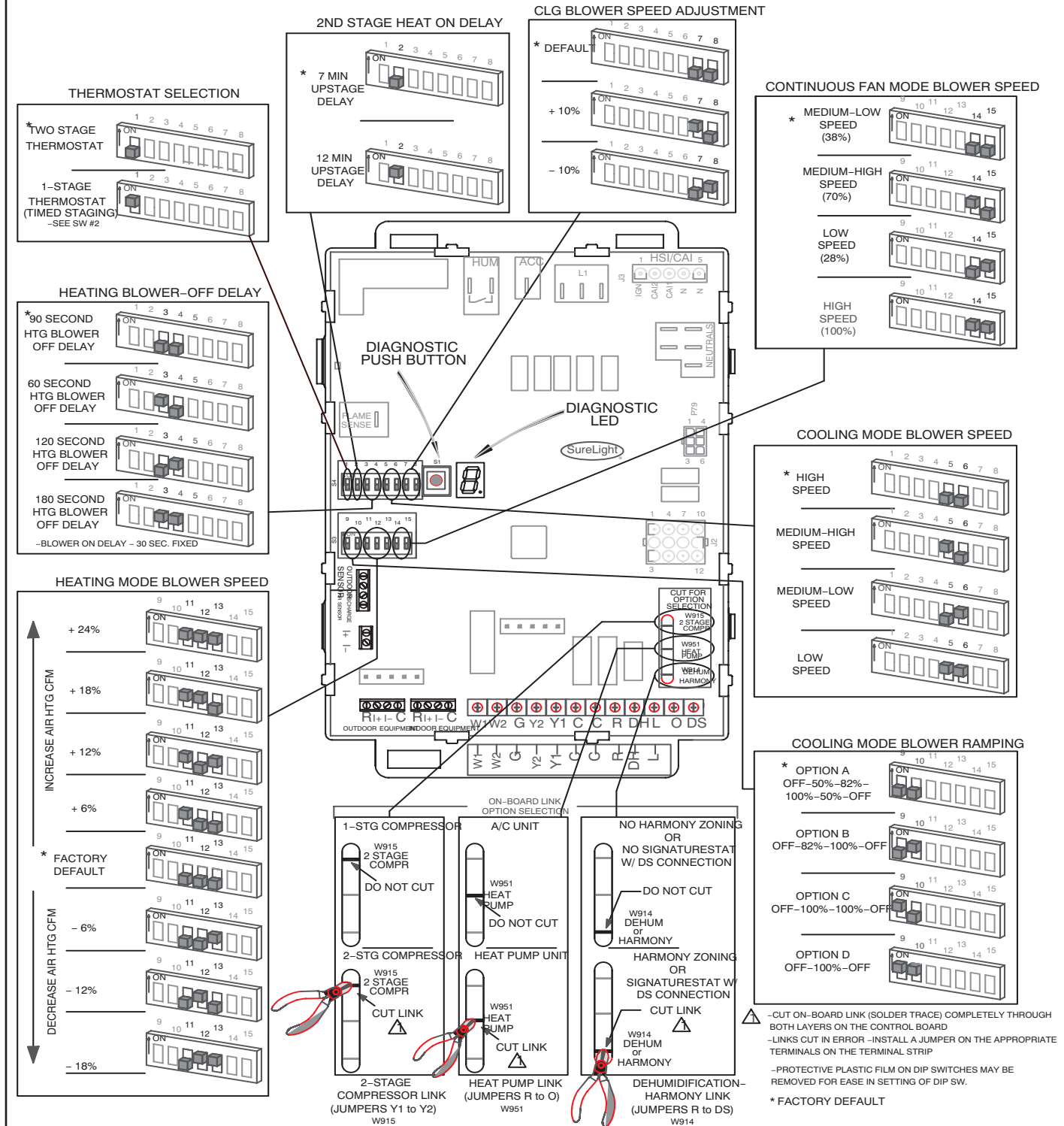

FIGURE 5

TABLE 4
Integrated Control Diagnostic Modes

Display	Action (when button released)
No change (idle)*	Remain in idle mode
Solid "E"	Enter diagnostic recall mode
Solid "D"	Discharge Air Installed
Solid "F"	Enter flame signal mode
Solid "P" (variable speed only)	Program unit capacity/size (Unit Code)
Two horizontal bars =	Soft disable

* No change implies the display will continue to show whatever is currently being displayed for normal operation (blinking decimal, active error code, heat state, etc..)

Diagnostic LED (Figure 5)

The seven-segment diagnostic LED displays operating status, target airflow, error codes and other information. The table beginning on Page 9 lists diagnostic LED codes.

Diagnostic Push Button (Figure 5)

The diagnostic push button is located adjacent to the seven-segment diagnostic LED. This button is used to enable the Error Code Recall "E" mode and the Flame Signal "F" mode. Press the button and hold it to cycle through a menu of options. Every five seconds a new menu item will be displayed. When the button is released, the displayed item will be selected. Once all items in the menu have been displayed, the menu resumes from the beginning until the button is released.

Error Code Recall Mode

Select "E" from the menu to access the most recent 10 error codes. Select "c" from the Error Code Recall menu to clear all error codes. Button must be pressed a second time while "c" is flashing to confirm command to delete codes. Press the button until a solid "≡" is displayed to exit the Error Code Recall mode.

Flame Signal Mode

Select "F" from the menu to access the flame signal mode. The integrated control will display the flame current on 7 segment LED in in micro amps (uA).

- Flame signal mode is exited after any of the following: Power is reset
- Pressing and holding push button until 3 horizontal lines "≡" are displayed
- 10 minutes after entering the flame sense mode.

Program Unit Capacity/Size Mode

After the "P" is selected (by releasing the push button) the integrated control will start flashing the "P" on display for 90 seconds. If push button is pressed again and held during that time, the control will start to display characters corresponding to different variable speed furnace models for 3 seconds each. While the wanted character-model is displayed push button has to be released. Selected option will flash display for 10 seconds and during that time push button has to be pressed and held for 5 seconds. Once control accepts new setting it will store data in non-volatile memory and reset itself. If 10 seconds expires or push button is held less than 5 seconds, control will exit field test mode and go into idle without changing programming the unit size.

Soft Disable

Soft disabling is when thermostat finds a device on the BUS that it does not recognize and the thermostat sends a the device a message to be in soft disabling mode until properly configured. Two horizontal bars will display.

Steps to follow if the damper control module is displaying the soft disable code.

- 1 - Confirm proper wiring between all devices (thermostat, damper control module, indoor and outdoor).
- 2 - Cycle power to the control that is displaying the soft disable code.
- 3 - Put the room thermostat through set up.
- 4 - Go to **setup / system devices / thermostat / edit / then push reset.**
- 5 - Go to **setup / system devices / thermostat / edit / then push resetAll.**

TABLE 5

Integrated Diagnostic Codes/Status of Equipment

Code	Diagnostic Codes/Status of Equipment	Action Required to Clear and Recover	
.	Idle mode (Decimal blinks at 1 Hertz -- 0.5 second ON, 0.5 second OFF).		
A	Cubic feet per minute (cfm) setting for indoor blower (1 second ON, 0.5 second OFF) / cfm setting for current mode displayed.		
C	Cooling stage (1 second ON, 0.5 second OFF) / 1 or 2 displayed / Pause / cfm setting displayed / Pause / Repeat codes).		
d	Dehumidification mode (1 second ON) / 1 second OFF) / cfm setting displayed / Pause / Repeat Codes).		
h	Heat pump stage (1 second ON, 0.5 second OFF) / % of input rate displayed / Pause / cfm setting / Pause / Repeat codes.		
H	Gas Heat Stage (1 second ON, 0.5 second OFF) / 1 or 2 displayed / Pause / cfm setting displayed / Pause / Repeat codes. Blinking during ignition.		
dF	Defrost mode.		
U	Discharge Air Temperature		
E105	Device communication problem - No other devices on RS BUS (Communication system).		Equipment is unable to communicate. Indicates numerous message errors. In most cases errors are related to electrical noise. Make sure high voltage power is separated from RSBus. Check for miswired and/or loose connections between the stat, indoor unit and outdoor unit. Check for a high voltage source of noise close to the system. Fault clears after communication is restored.
E110	Low line voltage.		Line Voltage Low (Voltage lower than nameplate rating). Check power line voltage and correct. Alarm clears 5 seconds after fault recovered.
E111	Low line voltage.	Reverse line power voltage wiring. System resumes normal operation 5 seconds after fault recovered.	
E112	Ground not detected	System shuts down. Provide proper earth ground. System resumes normal operation 5 seconds after fault recovered.	
E113	High line voltage.	Line Voltage High (Voltage higher than nameplate rating). Provide power voltage within proper range. System resumes normal operation 5 seconds after fault recovered.	
E114	Line voltage frequency out-of-range.	No 60 Hertz Power. Check voltage and line power frequency. Correct voltage and frequency problems. System resumes normal operation 5 seconds after fault recovered.	
E115	Low 24V - Control will restart if the error recovers.	24-Volt Power Low (Range is 18 to 30 volts). Check and correct voltage. Check for additional power-robbing equipment connected to system. May require installation of larger VA transformer to be installed in furnace / air handler. Clears after fault recovered.	
E116	High 24V.	24 Volt Power High (Range is 18 to 30 volts). Check and correct voltage. Check for proper line voltage (120V, 240V, etc.) to equipment. Clears when control senses proper voltage.	
E117	Poor ground detected (Warning only)	Provide proper grounding for unit. Check for proper earth ground to the system. Warning only will clear 30 seconds after fault recovered.	
E120	Unresponsive device. Communication only.	Usually caused by delay in outdoor unit responding to indoor unit polling. Recycle power. Check all wiring connections. Cleared after unresponsive device responds to any inquiry.	

TABLE 5 Continued

Code	Diagnostic Codes/Status of Equipment	Action Required to Clear and Recover
E124	Active communicating thermostat signal missing for more than 3 minutes.	Equipment lost communication with the thermostat. Check four wiring connections, ohm wires and cycle power at the thermostat. Alert stops all services and waits for heartbeat message from thermostat (subnet controller). Cleared after valid thermostat (subnet controller) message is received.
E125	Control failed self-check, internal error, failed hardware. Will restart if error recovers. Integrated control not communicating. Covers hardware errors (flame sense circuit faults, pin shorts, etc.).	Hardware problem on the control. Cycle power on control. Replace if problem prevents service and is persistent. Critical alert. Cleared 300 seconds after fault recovered.
E126	Control internal communication problem.	Hardware problem on the control. Cycle power on control. Replace if problem prevents service and is persistent. Cleared 300 seconds after fault recovered.
E131	Corrupted control parameters (Verify configuration of system). Communicating only.	Reconfigure the system. Replace control if heating or cooling is not available. Only applicable in the communicating mode, not in startup. Exit from Commissioning and Execute 'Set Factory Default mode Control will still operate on default parameter settings
E180	Outdoor air temperature sensor failure. Only shown if shorted or out-of-range.	Compare outdoor sensor resistance to temperature/ resistance charts in unit installation instructions. Replace sensor pack if necessary. At beginning of (any) configuration, furnace or air handler control will sense outdoor air and discharge air temperature sensor(s). If detected (reading in range), appropriate feature will be set as 'installed' and that could be seen in 'About' screen. In normal operation after control recognizes sensors, alarm will be sent if valid temperature reading is lost. To get rid of setting and alarm, redo configuration and make sure that temperature sensor is marked as 'not installed' in Indoor Unit 'About' screen. When Indoor unit control is replaced, thermostat will 'tell' new control if temperature sensor is in system or not. Clears 30 seconds after fault recovered.
E200	Hard lockout - Rollout circuit open or previously open.	Correct cause of rollout trip, or replace flame rollout switch. Test furnace operation. Cleared after fault recovered.
E201	Indoor blower communication failure - Unable to communicate with blower motor.	Indoor blower communication failure (including power outage). Lost communication with indoor blower motor. Possible causes: motor not powered, loose wiring. Problem may be on control or motor side. Cleared after fault recovered.
E202	Indoor blower motor mis-match - Indoor motor horsepower does not match unit capacity.	Incorrect appliance capacity code selected. Check for proper configuring under: Unit Size Codes for Furnace/Air Handler on configuration guide or in installation instructions. Cleared after the correct match is detected following a reset. (Remove thermostat from system while applying power and reprogramming.)
E203	Appliance capacity / size is NOT programmed. Invalid unit codes refer to configuration flow chart.	No appliance capacity code selected. Check for proper configuring under: Unit Size Codes for Furnace on configuration guide or in installation instructions. Critical Alert. Cleared after valid unit code is read following a reset. (Remove thermostat from system while applying power and reprogramming.)
E204	Gas valve mis-wired.	Check gas valve operation and wiring. Clears when repaired.
E205	Gas valve control relay contact shorted.	Check wiring on control and gas valve. If wiring is correct, replace control.

TABLE 5 Continued

Code	Diagnostic Codes/Status of Equipment	Action Required to Clear and Recover
E206	Gas valve second-stage relay failure	Furnace will operate on 1st stage for remainder of the heating demand. Will clear after fault recovered. If unable to operate 2nd stage, replace control.
E207	Hot surface ignitor sensed open.	Measure resistance of hot surface ignitor. Replace if open or not within specified range found in IOM. Resumes normal operation after fault is cleared.
E223	Low pressure switch failed open.	Check pressure (inches w.c.) of low pressure switch closing on heat call. Measure operating pressure (inches w.c.). Inspect vent and combustion air inducer for correct operation and restriction. Resumes normal operation after fault is cleared
E224	Low pressure switch failed closed.	Check operation of low pressure switch to see if it is stuck closed on heat call longer than 150 seconds. Measure operating pressure (inches w.c.). Inspect vent and combustion air inducer for correct operation and restriction. Resumes normal operation after fault is cleared.
E225	High pressure switch failed open.	Check pressure (inches w.c.) of high pressure switch closing on heat call. Measure operating pressure (inches w.c.). Inspect vent and combustion air inducer for correct operation and restriction. Resumes normal operation after fault is cleared.
E226	High pressure switch failed closed	Check operation of high pressure switch closing on heat call. Measure operating pressure (inches w.c.). Inspect vent and combustion air inducer for correct operation and restriction. Resumes normal operation after fault is cleared.
E227	Low pressure switch open during trial for ignition or run mode.	Check pressure (inches w.c.) of low pressure switch closing on heat call. Measure operating pressure (inches w.c.). Inspect vent and combustion air inducer for correct operation and restriction. Resumes normal operation after fault is cleared.
E228	Combustion air inducer calibration failure	Unable to perform pressure switch calibration. Check vent system and pressure switch wiring connections. Resumes normal operation after fault is cleared.
E229	Ignition on high fire	IFC switched to high fire ignition because low fire pressure switch did not close in allowed time. No action is needed.
E240	Low flame current - Run mode.	Check micro-amperes of flame sensor using control diagnostics or field-installed mode. Clean or replace sensor. Measure voltage of neutral to ground to ensure good unit ground. Alert clears after current heat call has been completed.
E241	Flame sensed out of sequence - Flame still present.	Shut off gas. Check for gas valve leak. Replace, if necessary. Alert clears when fault is recovered.
E250	Limit switch circuit open.	Check for proper firing rate on furnace. Ensure there is no blockage in heater. Check for proper air flow. If limit not closed within 3 minutes, unit will go into 1-hour soft lockout. Resumes normal operation after fault is cleared.
E252	Discharge air temperature too high (gas heat only).	Check temperature rise, air flow and input rate. Cleared when heat call is finished.
E270	Soft lockout - Exceeded maximum number of retries. No flame current sensed.	Check for proper gas flow. Ensure that ignitor is lighting burner. Check flame sensor current. Clears when heat call finishes successfully.

TABLE 5 Continued

Code	Diagnostic Codes/Status of Equipment	Action Required to Clear and Recover
E271	Soft lockout - Exceeded maximum number of retries. Last retry failed due to the pressure switch opening.	Check pressure (inches w.c.) of low pressure switch closing on heat call. Measure operating pressure (inches w.c.). Inspect vent and combustion air inducer for correct operation and restriction. Clears when heat call finishes successfully.
E272	Soft lockout - Exceeded maximum number of recycles. Last recycle due to the pressure switch opening.	Check operation of low pressure switch to see if it is stuck closed on heat call. Check pressure (inches w.c.) of high pressure switch closing on heat call. Measure operating pressure (inches w.c.). Inspect vent and combustion air inducer for correct operation and restriction. Clears when heat call finishes successfully.
E273	Soft lockout - Exceeded maximum number of recycles. Last recycle due to flame failure.	Check micro-amperes of flame sensor using control diagnostics or field-installed mode. Clean or replace sensor. Measure voltage of neutral to ground to ensure good unit ground. Clears when heat call finishes successfully.
E274	Soft lockout - Exceeded maximum number of recycles. Last recycle failed due to the limit circuit opening or limit remained open longer than 3 minutes	Shut down system. 1-hour soft lockout. Check firing rate and air flow. Check for blockage. Clears when heat call finishes successfully.
E275	Soft lockout - Flame sensed out of sequence. Flame signal is gone.	Shut off gas. Check for gas valve leak. 1-hour soft lockout. Clears when flame has been proven stable.
E276	Watchguard calibration failure.	Unable to perform pressure switch calibration. Check vent system and pressure switch wiring connections. 1-hour soft lockout. Clears when calibration has finished successfully.
E290	Ignitor circuit fault - Failed ignitor or triggering circuitry.	Measure resistance of hot surface ignitor. Replace if open or not within specifications. 1-hour soft lockout. Clears when flame has been proven stable.
E291	Heat air flow restricted below the minimum.	Check for dirty filter and air flow restriction. Check blower performance. 1-hour soft lockout. Cleared when heat call finishes successfully.
E292	Indoor blower motor unable to start due to obstructed wheel, seized bearings.	Indoor blower motor unable to start (seized bearing, stuck wheel, etc.). Replace motor or wheel if assembly does not operate or meet performance standards. 1-hour soft lockout. Clears after circulator successfully starts.
E294	Combustion air inducer over current.	Check combustion blower bearings, wiring and amps. Replace if does not operate or does not meet performance standards. Clears after inducer current is sensed to be in-range after the ignition following the soft lockout or reset.
E295	Indoor blower motor temperature is too high.	Indoor blower motor over temperature (motor tripped on internal protector). Check motor bearings and amps. Replace if necessary. Cleared after blower demand is satisfied.
E310	Discharge error temperature sensor failure. Only shown if shorted or out of range.	Compare outdoor sensor resistance to temperature/ resistance charts in installation instructions. Replace sensor if necessary. Cleared in Communicating mode: 30 seconds after fault recovered. In Non- Communicating mode: Cleared after the current heat call is completed.
E311	Heat rate reduced to match indoor blower air flow.	Warning Only. Furnace blower in cutback mode due to restricted airflow. Reduce firing rate every 60 seconds to match available CFM. Check filter and duct system. To clear, replace filter if needed or repair/ add duct. 2-stage controls will reduce firing rate to 1st stage. Clears when heat call finishes successfully.

TABLE 5 Continued

Code	Diagnostic Codes/Status of Equipment	Action Required to Clear and Recover
E312	Restricted air flow in cooling or continuous fan mode is lower than cfm setting.	Warning Only. Restricted airflow - Indoor blower is running at a reduced CFM (Cutback Mode - The variable speed motor has pre-set speed and torque limiters to protect the motor from damage caused by operating outside of design parameters (0 to 0.8" W.C.. total external static pressure). Check filter and duct system. To clear, replace filter if needed or repair/add duct. Cleared after the current service demand is satisfied.
E313	Indoor or outdoor unit capacity mismatch. Communication only.	Incorrect indoor/outdoor capacity code selected. Check for proper configuring in installation instructions. Alarm is just a warning. The system will operate, but might not meet efficiency and capacity parameters. Alarm will clear when commissioning is exited. Cleared after commissioning is complete.
E331	Global network connection - Communication link problem.	For Future Use.
E334	Relay "Y1" stuck on interated control.	Replace integrated control.
E347	No 24 Volt output on Y1 of "integrated control" with non communicating outdoor unit.	Operation stopped. Y1 relay / Stage 1 failed. (Pilot relay contacts did not close or the relay coil did not energize; no input back to IFC chip). Critical Alert. Cleared after reset and Y1 input sensed.
E348	No 24 Volt output on Y2 of "integrated control" with noncommunicating outdoor unit.	Y2 relay / Stage 2 failed. (Pilot relay contacts did not close or the relay coil did not energize; no input back to IFC chip). Critical Alert. Cleared after reset and Y1 input sensed.
E349	No 24 Volts between R & O on "integrated control" with non communicating outdoor unit (Dual fuel module required for heat pump application)	Configuration link R to O needs to be restored. Replace link or hardware. Applicable in non communicating mode. Critical Alert.
E370	Interlock switch sensed open for 2 minutes.	Control sees the loss of 24VAC for 2 minutes. Terminate all services and wait for interlock switch to close. The alarm will clear when 24VAC is continuously sensed on DS terminal for a minimum of 10 seconds or on a power reset.
E400	LSOM - Compressor internal overload tripped.	Thermostat demand Y1 is present; but, compressor is not running. Check power to outdoor unit. Clears the error after current is sensed in both RUN and START sensors for at least 2 seconds, or after service is removed, or after power reset.
E401	LSOM Compressor long run cycle or low system pressure.	Compressor ran more than 18 hours to satisfy a single thermostat demand. Critical Alert. Clears the error after 30 consecutive normal run cycles or power reset. Also monitors low pressure switch trips.
E402	LSOM - Outdoor unit system pressure trip.	Discharge or suction pressure out-of-limits, or compressor overloaded. Clears the error after 4 consecutive normal compressor run cycles.
E403	LSOM - Compressor short-cycling. (Running less than 4 minutes). Outdoor unit pressure trip	Compressor runs less than 3 minutes to satisfy a thermostat demand. Clears the error after 4 consecutive normal run cycles or power reset.
E404	LSOM - Compressor rotor locked. Compressor short-cycling. (Running less than 4 minutes).	Compressor rotor locked up due to run capacitor short, bearings are seized, excessive liquid refrigerant, etc. Clears the error after 4 consecutive normal run cycles or after power reset.
E405	LSOM - Compressor open circuit.	Compressor circuit open (due to power disconnection, open fuse, etc.) Clears the error after 1 normal compressor run cycle.

TABLE 5 Continued		
Code	Diagnostic Codes/Status of Equipment	Action Required to Clear and Recover
E406	LSOM - Compressor open start circuit.	Required amount of current is not passing through Start current transformer. Clears the error after current is sensed in START sensor, or after power reset.
E407	LSOM - Compressor open run circuit.	Required amount of current is not passing through Run current transformer. Clears the error after current is sensed in RUN sensor, or 1 normal compressor run cycle, or after power reset.
E408	LSOM - Compressor contactor is welded.	Compressor runs continuously. Clears the error after 1 normal compressor run cycle or after power reset.
E409	LSOM - Compressor low voltage.	Secondary voltage is below 18VAC. After 10 minutes, operation is discontinued. Clears the code after voltage is higher than 20 VAC for 2 seconds or after power reset.

DIP Switch Settings

NOTE - All icomfort settings are set at the icomfort Wi-Fi® thermostat. See icomfort installation instruction. In icomfort communication system all DIP switch and clippable link settings are ignored. For conventional thermostats proceed with DIP switch and clippable link settings as outlined in the following.

Heating Operation DIP Switch Settings

Switch 1 -- Thermostat Selection -- This unit may be used with either a single-stage or two-stage thermostat. The thermostat selection is made using a DIP switch which must be properly positioned for the particular application. The DIP switch is factory-positioned for use with a two-stage thermostat. If a single-stage thermostat is to be used, the DIP switch must be repositioned.

- Select "OFF" for two-stage heating operation controlled by a two-stage heating thermostat (factory setting);
- Select "ON" for two-stage heating operation controlled by a single-stage heating thermostat. This setting provides a timed delay before second-stage heat is initiated.

Switch 2 -- Second Stage Delay (Used with Single-

Stage Thermostat Only) -- This switch is used to determine the second stage on delay when a single-stage thermostat is being used. The switch is factory-set in the OFF position, which provides a 7-minute delay before second-stage heat is initiated. If the switch is toggled to the ON position, it will provide a 12-minute delay before second-stage heat is initiated. This switch is only activated when the thermostat selector jumper is positioned for SINGLE-stage thermostat use.

Switches 3 and 4 -- Blower-Off Delay -- The blower-on delay of 30 seconds is not adjustable. The blower-off delay (time that the blower operates after the heating demand has been satisfied) can be adjusted by moving switches 3 and 4 on the integrated control. The unit is shipped from the factory with a blower-off delay of 90 seconds. The blower off delay affects comfort and is adjustable to satisfy individual applications. Adjust the blower off delay to achieve a supply air temperature between 90° and 110°F at the exact moment that the blower is de-energized. Longer off delay settings provide lower supply air temperatures; shorter settings provide higher supply air temperatures. Table 6 provides the blower off timings that will result from different switch settings.

TABLE 6

Blower Off Delay Switch Settings		
Blower Off Delay Seconds	Switch 3	Switch 4
60	On	Off
90 (factory)	Off	Off
120	Off	On
180	On	On

Indoor Blower Operation DIP Switch Settings

Switches 5 and 6 -- Cooling Mode Blower Speed -- The unit is shipped from the factory with the dip switches positioned for high speed (4) indoor blower motor operation during the cooling mode. Table 7 provides the cooling mode blower speeds that will result from different switch settings. Switches 5 and 6 set the blower cfm for second-stage cool. The integrated control automatically ramps down to 70% of the second-stage cfm for first-stage cfm. Refer to tables for corresponding cfm values.

TABLE 7

Cooling Mode Blower Speeds		
Speed	Switch 5	Switch 6
Low	On	On
Medium Low	Off	On
Medium High	On	Off
High (factory)	Off	Off

Switches 7 and 8 -- Cooling Blower Speed Adjustment

-- The unit is shipped from the factory with the dip switches positioned for NORMAL (no) adjustment. The dip switches may be positioned to adjust the blower speed by +10% or -10% to better suit the application. Table 8 below provides blower speed adjustments that will result from different switch settings. Refer to tables for corresponding cfm values.

TABLE 8

Cooling Blower Speed Adjustment		
Adjustment	Switch 7	Switch 8
+10% (approx)	On	Off
Factory Default	Off	Off
-10% (approx)	Off	Off

Switches 9 and 10 -- Cooling Mode Blower Speed Ramping -- Blower speed ramping may be used to enhance dehumidification performance. The switches are factory set at option A which has the greatest effect on dehumidification performance. Table 9 provides the cooling mode blower speed ramping options that will result from different switch settings. The cooling mode blower speed ramping options are detailed below.

TABLE 9

Cooling Mode Blower Speed Ramping		
Ramping	Switch 9	Switch 10
A (Factory)	Off	Off
B	Off	On
C	On	Off
D	On	On

Ramping Option A (Factory Selection)

- Motor runs at 50% for 30 seconds.
- Motor then runs at 82% for approximately 7-1/2 minutes.
- If demand has not been satisfied after 7-1/2 minutes, motor runs at 100% until demand is satisfied.
- Once demand is met, motor runs at 50% for 30 seconds then ramps down to stop.

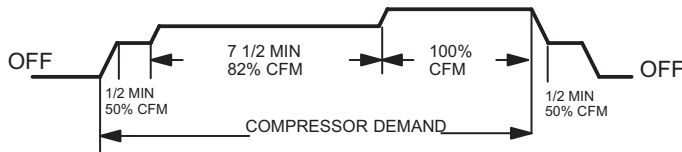

Ramping Option B

- Motor runs at 82% for approximately 7-1/2 minutes. If demand has not been satisfied after 7-1/2 minutes, motor runs at 100% until demand is satisfied.
- Once demand is met, motor ramps down to stop.



Ramping Option C

- Motor runs at 100% until demand is satisfied.
- Once demand is met, motor runs at 100% for 45 seconds then ramps down to stop.

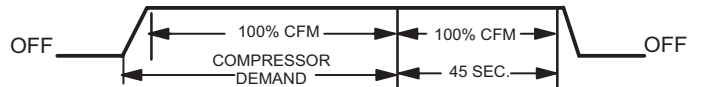

Ramping Option D

- Motor runs at 100% until demand is satisfied.
- Once demand is met, motor ramps down to stop.

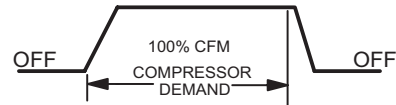

Switches 11, 12 and 13 -- Heating Mode Blower Speed

The switches are factory set to the OFF position which provides factory default heat speed. Refer to Table 10 for switches 11, 12 and 13 that provided the corresponding increases or decrease to both high and low heat demand.

TABLE 10

Heating Mode Blower Speeds			
Heat Speed	Switch 11	Switch 12	Switch 13
Increase 24%	On	On	On
Increase 18%	On	On	Off
Increase 12%	On	Off	On
Increase 6%	On	Off	Off
Factory Default	Off	Off	Off
Decrease 6%	Off	Off	On
Decrease 12%	Off	On	Off
Decrease 18%	Off	On	On

Switches 14 and 15 -- Continuous Blower Speed --

Table 11 provides continuous blower speed adjustments that will result from different switch settings.

TABLE 11

Continuous Blower Speed		
Continuous Blower Speed	Switch 14	Switch 15
28% of High Cool Speed	Off	On
38% of High Cool Speed (Factory)	Off	Off
70% of High Cool Speed	On	Off
100% of High Cool Speed	On	On

BLOWER DATA

SL280UH060NV36A BLOWER PERFORMANCE (less filter)

BOTTOM RETURN AIR

0 through 0.8 in. w.g. (Heating) and 0 through 1.0 in. w.g. (Cooling) External Static Pressure Range

HEATING

¹ Heating Speed DIP Switch Settings	First Stage Heating Speed - cfm	Second Stage Heating Speed - cfm
+24%	1030	1140
+18%	965	1075
+12%	925	1020
+6%	870	965
Factory Default	825	915
-6%	775	865
-12%	735	810
-18%	685	760

COOLING

¹ Cooling Speed DIP Switch Settings	First Stage Cooling Speed - cfm				Second Stage Cooling Speed - cfm			
	Low	Medium-Low	Medium-High	² High	Low	Medium-Low	Medium-High	² High
+	595	715	815	920	845	1015	1175	1340
Factory Default	565	680	735	840	790	945	1070	1215
-	510	610	695	780	715	845	980	1120

SL280UH060NV36A BLOWER PERFORMANCE (less filter)

SINGLE SIDE RETURN AIR

0 through 0.8 in. w.g. (Heating) and 0 through 1.0 in. w.g. (Cooling) External Static Pressure Range

HEATING

¹ Heating Speed DIP Switch Settings	First Stage Heating Speed - cfm	Second Stage Heating Speed - cfm
+24%	985	1100
+18%	950	1050
+12%	875	1000
+6%	850	935
Factory Default	800	890
-6%	750	840
-12%	700	790
-18%	680	740

COOLING

¹ Cooling Speed DIP Switch Settings	First Stage Cooling Speed - cfm				Second Stage Cooling Speed - cfm			
	Low	Medium-Low	Medium-High	² High	Low	Medium-Low	Medium-High	² High
+	575	700	800	890	835	990	1145	1300
Factory Default	535	630	745	825	760	890	1020	1185
-	475	580	645	750	690	820	950	1055

¹ Cooling and heating speeds are based on a combination of DIP switch settings on the furnace control. Refer to Installation Instructions for specific DIP Switch Settings.

² Factory default setting.

NOTES - The effect of static pressure is included in air volumes shown.

First stage HEAT is approximately 91% of the same second stage HEAT.

First stage COOL (two-stage air conditioning units only) is approximately 70% of the same second stage COOL speed position.

Continuous Fan Only speed is selectable at 28%, 38%, 70% and 100% of the selected second stage cooling speed - minimum 250 cfm.

Lennox iHarmony® Zoning System Applications - Minimum blower speed is 250 cfm.

BLOWER DATA

SL280UH080NV48B BLOWER PERFORMANCE (less filter)

BOTTOM RETURN AIR

0 through 0.8 in. w.g. (Heating) and 0 through 1.0 in. w.g. (Cooling) External Static Pressure Range

HEATING

¹ Heating Speed DIP Switch Settings	First Stage Heating Speed - cfm	Second Stage Heating Speed - cfm
+24%	1350	1500
+18%	1270	1420
+12%	1200	1340
+6%	1130	1270
Factory Default	1060	1190
-6%	970	1130
-12%	880	1025
-18%	845	950

COOLING

¹ Cooling Speed DIP Switch Settings	First Stage Cooling Speed - cfm				Second Stage Cooling Speed - cfm			
	Low	Medium-Low	Medium-High	² High	Low	Medium-Low	Medium-High	² High
+	640	870	1030	1200	1020	1310	1535	1750
Factory Default	590	770	925	1100	935	1200	1400	1600
-	545	635	750	960	815	1080	1260	1430

SL280UH080NV48B BLOWER PERFORMANCE (less filter)

SINGLE SIDE RETURN AIR

0 through 0.8 in. w.g. (Heating) and 0 through 1.0 in. w.g. (Cooling) External Static Pressure Range

HEATING

¹ Heating Speed DIP Switch Settings	First Stage Heating Speed - cfm	Second Stage Heating Speed - cfm
+24%	1245	1385
+18%	1180	1320
+12%	1130	1245
+6%	1045	1185
Factory Default	1095	1120
-6%	1020	1050
-12%	825	975
-18%	840	865

COOLING

¹ Cooling Speed DIP Switch Settings	First Stage Cooling Speed - cfm				Second Stage Cooling Speed - cfm			
	Low	Medium-Low	Medium-High	² High	Low	Medium-Low	Medium-High	² High
+	600	810	995	1165	995	1265	1490	1680
Factory Default	560	705	855	1050	905	1140	1350	1525
-	540	585	750	910	735	1010	1200	1365

¹ Cooling and heating speeds are based on a combination of DIP switch settings on the furnace control. Refer to Installation Instructions for specific DIP Switch Settings.² Factory default setting.

NOTES - The effect of static pressure is included in air volumes shown.

First stage HEAT is approximately 91% of the same second stage HEAT.

First stage COOL (two-stage air conditioning units only) is approximately 70% of the same second stage COOL speed position.

Continuous Fan Only speed is selectable at 28%, 38%, 70% and 100% of the selected second stage cooling speed - minimum 380 cfm.

Lennox iHarmony® Zoning System Applications - Minimum blower speed is 380 cfm.

BLOWER DATA

SL280UH080NV48B BLOWER PERFORMANCE (less filter)

SIDE RETURN AIR WITH OPTIONAL RETURN AIR BASE

0 through 0.8 in. w.g. (Heating) and 0 through 1.0 in. w.g. (Cooling) External Static Pressure Range

HEATING

¹ Heating Speed DIP Switch Settings	First Stage Heating Speed - cfm	Second Stage Heating Speed - cfm
+24%	1300	1445
+18%	1230	1355
+12%	1145	1300
+6%	1215	1225
Factory Default	1015	1150
-6%	1050	1070
-12%	860	1000
-18%	750	935

COOLING

¹ Cooling Speed DIP Switch Settings	First Stage Cooling Speed - cfm				Second Stage Cooling Speed - cfm			
	Low	Medium-Low	Medium-High	² High	Low	Medium-Low	Medium-High	² High
+	625	835	1000	1190	1000	1280	1500	1715
Factory Default	590	760	910	1070	910	1180	1360	1560
-	540	655	800	940	760	1040	1230	1380

SL280UH080NV60C BLOWER PERFORMANCE (less filter)

BOTTOM RETURN AIR, RETURN AIR FROM BOTH SIDES OR RETURN AIR FROM BOTTOM AND ONE SIDE

0 through 0.8 in. w.g. (Heating) and 0 through 1.0 in. w.g. (Cooling) External Static Pressure Range

HEATING

¹ Heating Speed DIP Switch Settings	First Stage Heating Speed - cfm	Second Stage Heating Speed - cfm
+24%	1375	1530
+18%	1330	1450
+12%	1260	1390
+6%	1185	1315
Factory Default	1130	1235
-6%	1050	1165
-12%	980	1090
-18%	940	1020

COOLING

¹ Cooling Speed DIP Switch Settings	First Stage Cooling Speed - cfm				Second Stage Cooling Speed - cfm			
	Low	Medium-Low	Medium-High	² High	Low	Medium-Low	Medium-High	² High
+	1080	1235	1410	1655	1540	1745	2000	2300
Factory Default	975	1125	1290	1500	1390	1595	1815	2130
-	880	1010	1165	1360	1265	1440	1630	1930

¹ Cooling and heating speeds are based on a combination of DIP switch settings on the furnace control. Refer to Installation Instructions for specific DIP Switch Settings.² Factory default setting.

NOTES - The effect of static pressure is included in air volumes shown.

First stage HEAT is approximately 91% of the same second stage HEAT.

First stage COOL (two-stage air conditioning units only) is approximately 70% of the same second stage COOL speed position.

Continuous Fan Only speed is selectable at 28%, 38%, 70% and 100% of the selected second stage cooling speed - minimum 380 cfm.

Lennox iHarmony® Zoning System Applications - Minimum blower speed is 380 cfm for 08048B and 450cfm for 08060C

BLOWER DATA

SL280UH080NV60C BLOWER PERFORMANCE (less filter)

Single Side Return Air - Air volumes in **bold** require Optional Return Air base and field fabricated transition to accommodate 20 x 25 x 1 in. air filter in order to maintain proper air velocity.

0 through 0.8 in. w.g. (Heating) and 0 through 1.0 in. w.g. (Cooling) External Static Pressure Range

HEATING		
¹ Heating Speed DIP Switch Settings	First Stage Heating Speed - cfm	Second Stage Heating Speed - cfm
+24%	1350	1485
+18%	1280	1420
+12%	1220	1345
+6%	1155	1270
Factory Default	1100	1200
-6%	1020	1135
-12%	965	1070
-18%	870	980

COOLING								
¹ Cooling Speed DIP Switch Settings	First Stage Cooling Speed - cfm				Second Stage Cooling Speed - cfm			
	Low	Medium-Low	Medium-High	² High	Low	Medium-Low	Medium-High	² High
+	1050	1180	1350	1570	1500	1700	1915	2240
Factory Default	960	1080	1225	1420	1370	1540	1760	2035
-	845	950	1110	1290	1235	1390	1570	1840

BLOWER DATA

SL280UH100NV60C BLOWER PERFORMANCE (less filter)

BOTTOM RETURN AIR, RETURN AIR FROM BOTH SIDES OR RETURN AIR FROM BOTTOM AND ONE SIDE

0 through 0.8 in. w.g. (Heating) and 0 through 1.0 in. w.g. (Cooling) External Static Pressure Range

HEATING

¹ Heating Speed DIP Switch Settings	First Stage Heating Speed - cfm	Second Stage Heating Speed - cfm
+24%	1745	1930
+18%	1670	1825
+12%	1580	1740
+6%	1500	1655
Factory Default	1425	1565
-6%	1310	1470
-12%	1260	1390
-18%	1190	1300

COOLING

¹ Cooling Speed DIP Switch Settings	First Stage Cooling Speed - cfm				Second Stage Cooling Speed - cfm			
	Low	Medium-Low	Medium-High	² High	Low	Medium-Low	Medium-High	² High
+	1200	1250	1380	1585	1710	1790	1950	2270
Factory Default	1075	1150	1275	1460	1570	1610	1785	2065
-	1010	1050	1150	1320	1410	1480	1625	1880

SL280UH100NV60C BLOWER PERFORMANCE (less filter)

Single Side Return Air - Air volumes in **bold** require Optional Return Air base and field fabricated transition to accommodate 20 x 25 x 1 in. air filter in order to maintain proper air velocity.

0 through 0.8 in. w.g. (Heating) and 0 through 1.0 in. w.g. (Cooling) External Static Pressure Range

HEATING

¹ Heating Speed DIP Switch Settings	First Stage Heating Speed - cfm	Second Stage Heating Speed - cfm
+24%	1600	1785
+18%	1530	1685
+12%	1440	1600
+6%	1370	1515
Factory Default	1290	1415
-6%	1260	1390
-12%	1175	1290
-18%	1065	1190

COOLING

¹ Cooling Speed DIP Switch Settings	First Stage Cooling Speed - cfm				Second Stage Cooling Speed - cfm			
	Low	Medium-Low	Medium-High	² High	Low	Medium-Low	Medium-High	² High
+	1140	1180	1300	1480	1615	1695	1865	2160
Factory Default	1040	1060	1190	1365	1460	1530	1690	1960
-	930	970	1070	1240	1325	1380	1520	1760

¹ Cooling and heating speeds are based on a combination of DIP switch settings on the furnace control. Refer to Installation Instructions for specific DIP Switch Settings.

² Factory default setting.

NOTES - The effect of static pressure is included in air volumes shown.

First stage HEAT is approximately 91% of the same second stage HEAT.

First stage COOL (two-stage air conditioning units only) is approximately 70% of the same second stage COOL speed position.

Continuous Fan Only speed is selectable at 28%, 38%, 70% and 100% of the selected second stage cooling speed - minimum 450 cfm.

Lennox iHarmony® Zoning System Applications - Minimum blower speed is 450 cfm.

On-Board Links

Note: In icomfort systems with a conventional outdoor unit (non-communicating), the on-board clippable links must be set to properly configure the system.

WARNING

Carefully review all configuration information provided. Failure to properly set DIP switches, jumpers and on-board links can result in improper operation!

On-Board Link W914 Dehum or Harmony (R to DS)

On-board link W914, is a clippable connection between terminals R and DS on the integrated control. W914 must be cut when the furnace is installed with either the Harmony III zone control or a thermostat which features humidity control. If the link is left intact the PMW signal from the Harmony III control will be blocked and also lead to control

damage. Refer to Table 12 for operation sequence in applications including SL280UHNV, a thermostat which features humidity control and a single-speed outdoor unit. Table 13 gives the operation sequence in applications with a two-speed outdoor unit.

On-Board Link W951 Heat Pump (R to O)

On-board link W951 is a clippable connection between terminals R and O on the integrated control. W951 must be cut when the furnace is installed in applications which include a heat pump unit and a thermostat which features dual fuel use. If the link is left intact, terminal "O" will remain energized eliminating the HEAT MODE in the heat pump.

On-Board Link W915 2 Stage Compr (Y1 to Y2)

On-board link W915 is a clippable connection between terminals Y1 and Y2 on the integrated control. W915 must be cut if two-stage cooling will be used. If the Y1 to Y2 link is not cut the outdoor unit will operate in second-stage cooling only.

**TABLE 12
OPERATING SEQUENCE**

SL280UHV, Non-Communicating Thermostat with Humidity Control Feature and Single-Speed Outdoor Unit

OPERATING SEQUENCE		SYSTEM DEMAND				SYSTEM RESPONSE				
System Condition	Step	Thermostat Demand				Relative Humidity		Compressor	Blower CFM (cool)	Comments
		Y1	O	G	W1	Status	D			
NO CALL FOR DEHUMIDIFICATION										
Normal Operation	1	On	On	On		Acceptable	24 VAC	High	100%	Compressor and indoor blower follow thermostat demand
BASIC MODE (only active on a Y1 thermostat demand)										
Normal Operation	1	On	On	On		Acceptable	24 VAC	High	100%	ComfortSense® 7500 thermostat energizes Y1 and de-energizes D on a call for dehumidification
Dehumidification call	2	On	On	On		Demand	0 VAC	High	70%*	
PRECISION MODE (operates independent of a Y1 demand)										
Normal Operation	1	On	On	On		Acceptable	24 VAC	High	100%	Dehumidification mode begins when humidity is greater than set point
Dehumidification Call	2	On	On	On		Demand	0 VAC	High	70%*	
Dehumidification Call Only	1	On	On	On		Demand	0 VAC	High	70%*	ComfortSense® 7500 thermostat will try to maintain room humidity setpoint by allowing the room space to maintain a cooler room thermostat setpoint**
		Jumpers at indoor unit with a single stage outdoor unit. With Condensing unit - Cut W914 (R to DS) on SureLight® control With Heat Pump - Cut W914 (R to DS) & W951 (R to O) on SureLight® control								

Dave Lennox ComfortSense® 7500 thermostat to use for this application - Y2081 4 heat / 2 cool

*Dehumidification blower speed is 70% of COOL speed for all units .

**In Precision mode, ComfortSense® 7000 thermostat will maintain room temperature up to 2 °F (1.2°C) cooler than room setting.

**TABLE 13
OPERATING SEQUENCE**

SL280UHV, Non-Communicating Thermostat with Humidity Control Feature and Two-Speed Outdoor Unit

OPERATING SEQUENCE		SYSTEM DEMAND						SYSTEM RESPONSE				
System Condition	Step	Thermostat Demand						Relative Humidity		Compressor	Blower CFM (cool)	Comments
		Y1	Y2	O	G	W1	W2	Status	D			
NO CALL FOR DEHUMIDIFICATION												
Normal Operation Y1	1	On		On	On			Acceptable	24 VAC	Low	70%*	Compressor and indoor blower follow thermostat demand
Normal Operation Y2	2	On	On	On	On			Acceptable	24 VAC	High	100%	
ROOM THERMOSTAT CALLS FOR FIRST STAGE COOLING												
BASIC MODE (only active on a Y1 thermostat demand)												
Normal Operation	1	On		On	On			Acceptable	24 VAC	Low	70%*	ComfortSense® 7500 thermostat energizes Y1 and de-energizes D on a call for de-humidification
Dehumidification call	2	On	On	On	On			Demand	0 VAC	High	70%**	
PRECISION MODE (operates independent of a Y1 demand)												
Normal Operation	1	On		On	On			Acceptable	24 VAC	Low	70%*	Dehumidification mode begins when humidity is greater than set point
Dehumidification Call	2	On	On	On	On			Demand	0 VAC	High	70%**	
Dehumidification Call Only	1	On	On	On	On			Demand	0 VAC	High	70%**	ComfortSense® 7500 thermostat will try to maintain room humidity setpoint by allowing the room space to maintain a cooler room thermostat setpoint**
ROOM THERMOSTAT CALLS FOR FIRST AND SECOND STAGE COOLING												
BASIC MODE (only active on a Y1 thermostat demand)												
Normal Operation	1	On	On	On	On			Acceptable	24 VAC	High	100%	ComfortSense® 7500 thermostat energizes Y2 and de-energizes D on a call for de-humidification
Dehumidification Call	2	On	On	On	On			Demand	0 VAC	High	70%**	
PRECISION MODE (operates independent of a Y1 thermostat demand)												
Normal Operation	1	On		On	On			Acceptable	24 VAC	Low	70%*	Dehumidification mode begins when humidity is greater than set point
Dehumidification Call	2	On	On	On	On			Demand	0 VAC	High	70%**	
Dehumidification Call ONLY	1	On	On	On	On			Demand	0 VAC	High	70%**	ComfortSense® 7500 thermostat will try to maintain room humidity setpoint by allowing the room space to maintain a cooler room thermostat setpoint***
	Jumpers at indoor unit with a two stage outdoor unit Cut factory jumper from Y1 to Y2 or cut W915 (Y1 to Y2) With Condensing unit - Cut W914 (R to DS) on SureLight® control With Heat Pump - Cut W914 (R to DS) & W951 (R to O) on SureLight® control											
<i>Dave Lennox ComfortSense® 7500 thermostat to use for this application - Y2081 4 heat / 2 cool</i>												
<i>*Normal operation first stage cooling blower speed is 70% COOL speed.</i>												
<i>**Dehumidification blower speed is, reduced to 70% of COOL.</i>												
<i>***In Precision mode, ComfortSense® 7000 thermostat will maintain room temperature up to 2 °F (1.2°C) cooler than room setting.</i>												

B- Indoor Blower Motor

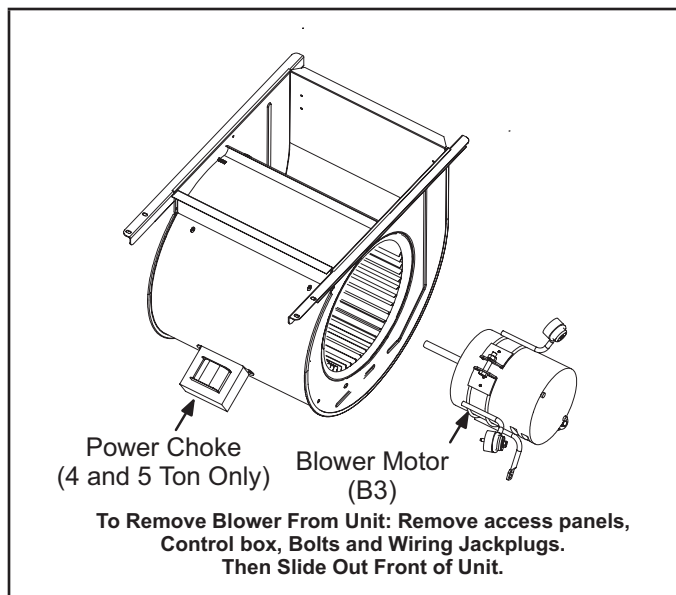

FIGURE 6

⚠ WARNING

During blower operation, the ECM motor emits energy that may interfere with pacemaker operation. Interference is reduced by both the sheet metal cabinet and distance.

During blower operation, the ECM motor emits energy that may interfere with pacemaker operation. Interference is reduced by both the sheet metal cabinet and distance. The motor communicates with the integrated control via a 2-way serial connection. The motor receives all necessary functional parameters from the integrated control and does not rely on a factory program like traditional variable speed motors. SL280UHNV units use a three-phase, electronically controlled D.C. brushless motor (controller converts single phase a.c. to three phase D.C.), with a permanent-magnettype rotor (Figure 7). Because this motor has a permanent magnet rotor it does not need brushes like conventional D.C. motors.

The stator windings are split into three poles which are electrically connected to the controller. This arrangement allows motor windings to turn on and off in sequence by the controller.

⚠ IMPORTANT

Earlier ECM motors used on other Lennox furnace models are not interchangeable with motors used on the SL280UH furnace line.

A solid-state controller is permanently attached to the motor. The controller is primarily an A.C. to D.C. converter. Converted D.C. power is used to drive the motor. The controller contains a microprocessor which monitors varying conditions inside the motor (such as motor workload).

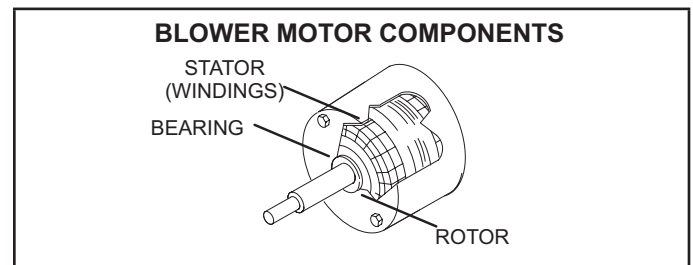

FIGURE 7

The controller uses sensing devices to sense what position the rotor is in at any given time. By sensing the position of the rotor and then switching the motor windings on and off in sequence, the rotor shaft turns the blower.

All SL280UHNV blower motors use single phase power. An external run capacitor is not used. The motor uses permanently lubricated ball-type bearings.

Internal Operation

The motor is controlled via serial communication between the integrated control on the furnace and the controller attached to the motor shell. The messages sent back and forth between the two controls serve to communicate rotational direction, demand, motor size, current draw, torque, and rpm, among other variables.

Motor rpm is continually adjusted internally to maintain constant static pressure against the blower wheel. The controller monitors the static work load on the motor and motor ampdraw to determine the amount of rpm adjustment. Blower rpm may be adjusted any amount in order to maintain a constant cfm as shown in Blower Ratings Tables. The cfm remains relatively stable over a broad range of static pressure. Since the blower constantly adjusts rpm to maintain a specified cfm, motor rpm is not rated. Hence, the terms "cool speed", "heat speed" or "speed tap" in this manual, on the unit wiring diagram and on blower B3, refer to blower cfm regardless of motor rpm.



Initial Power Up

When line voltage is applied to B3, there will be a large inrush of power lasting less than 1/4 second. This inrush charges a bank of DC filter capacitors inside the controller. If the disconnect switch is bounced when the disconnect is closed, the disconnect contacts may become welded. Try not to bounce the disconnect switch when applying power to the unit.

Motor Start-Up

When B3 begins start-up, the motor gently vibrates back and forth for a moment. This is normal. During this time the electronic controller is determining the exact position of the rotor. Once the motor begins turning, the controller slowly eases the motor up to speed (this is called "soft-start"). The motor may take as long as 10-15 seconds to reach full speed. If the motor does not reach 200 rpm within 13 seconds, the motor shuts down. Then the motor will immediately attempt a restart. The shutdown feature provides protection in case of a frozen bearing or blocked blower wheel. The motor may attempt to start eight times. If the motor does not start after the eighth try, the controller locks out. Reset controller by momentarily turning off power to unit.

The DC filter capacitors inside the controller are connected electrically to the motor supply wires. The capacitors take approximately 5 minutes to discharge when the disconnect is opened. For this reason it is necessary to wait at least 5 minutes after turning off power to the unit before attempting to service motor.

 DANGER	
	Disconnect power from unit and wait at least five minutes to allow capacitors to discharge before attempting to service motor. Failure to wait may cause personal injury or death.

Power Choke (L13)

A choke coil is used on SL280UHNV 4 and 5 ton units equipped with 1 hp motors. The choke is located on the blower housing and is used to suppress transient current spikes.

Troubleshooting Motor Operation

To verify motor operation see steps below and Figure 8 and Figure 9.

- 1 - Remove J48 (5 pin power plug) from P48 on the motor.
- 2 - With the power on at the furnace and door switch depressed, use a test meter to verify 120V between pins 4 and 5 on J48.
- 3 - Reconnect J48 to P48 on the motor.
- 4 - Remove J49 (4 pin low voltage connector) from P49 on the motor.
- 5 - Using test jumpers, apply 24V to pins 3 and 4 on P49 on the motor.

Note: Do not apply 24V to pins 2 and 4 on P49. Doing so will cause permanent damage to the motor.

- 6 - 6- Motor should run at 75%.
- 7 - Test is complete. Remove jumpers and reconnect plugs.

Another option is to use the TECMate PRO motor tester with the 16 to 4 pin adaptor. The use of the TECMate PRO isolates the motor from the integrated control. Follow the instructions provided with the kit. If the motor runs do not replace.

BLOWER B3 HARNESS CONNECTORS

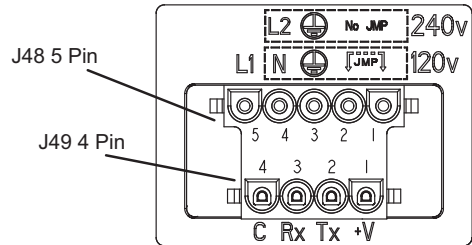
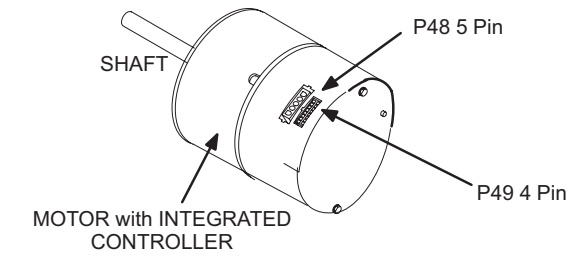

J49 4 Pin Control Connector	
PIN	DESCRIPTION
1	12V INPUT
2	SERIAL DATA OUTPUT
3	SERIAL DATA INPUT
4	COMMON

J48 5 Pin Line Voltage Connector	
PIN	DESCRIPTION
1	JUMPER PIN 1 TO PIN 2 FOR 120VAC LINE INPUT ONLY ***
2	120VAC LINE INPUT ONLY ***
3	CHASSIS GROUND
4	AC LINE
5	AC LINE

FIGURE 8

BLOWER B3 HARNESS CONNECTORS

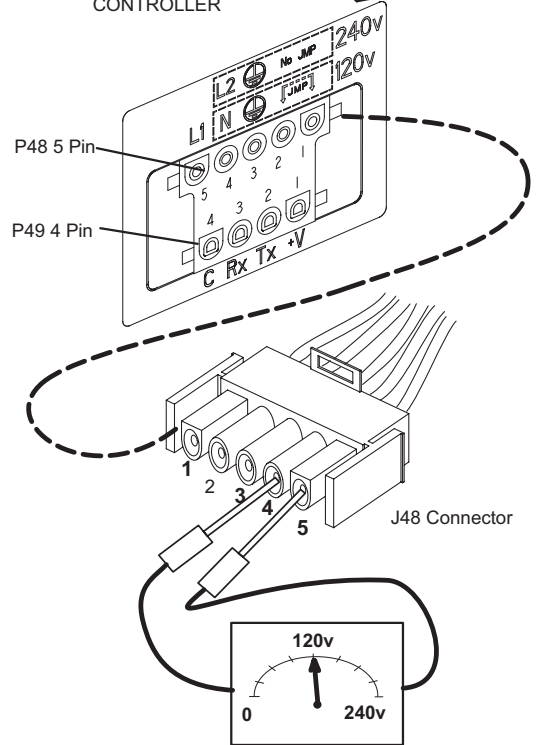
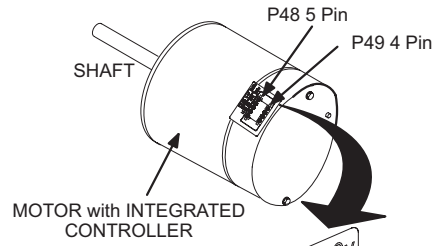

J48 Connector installed on motor

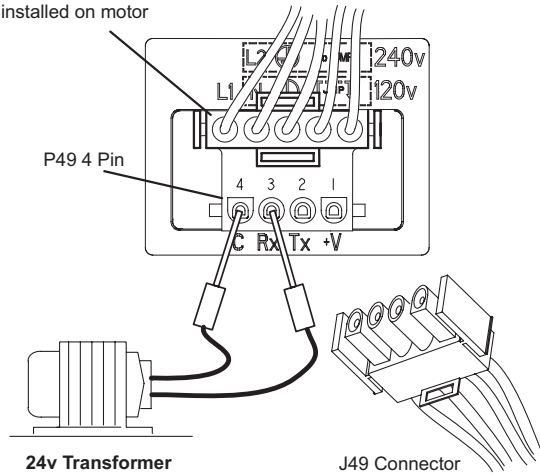

FIGURE 9

Troubleshooting Motor Windings

Ensure that motor windings are not damaged by performing the following tests:

NOTE - If your ohm meter is not an auto-ranging type, set it to the highest ohm scale (100k ohms or greater) before performing tests.

TABLE 14

Ohm Meter Range		
Scale	Measurement Range	
	In Words	ohms
2M	two megohm - two million ohms	0 - 2,000,000
200k	two hundred kilohm - two hundred thousand ohms	0 - 200,000
20k	twenty kilohm -- twenty thousand ohms	0-20,000
2k	two kilohm -- two thousand ohms	0 - 2,000
200	two hundred ohm	0 - 200

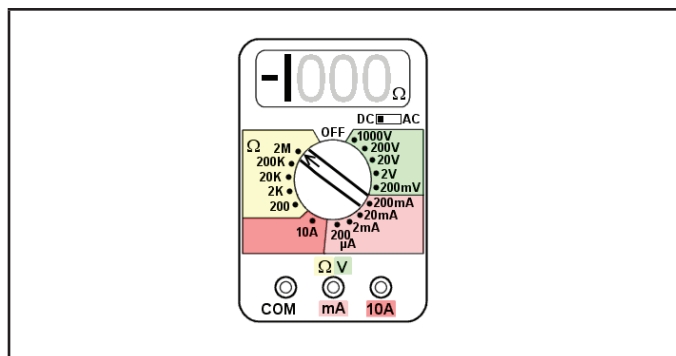

FIGURE 10

TEST A

Measure the resistance between each of the three motor leads (3-pin plug) and the unpainted part of the end shield.

If the winding resistance to ground is <100k ohms, replace the motor and control module. If the resistance to ground is >100k, the motor windings are fine. Proceed to Test B.

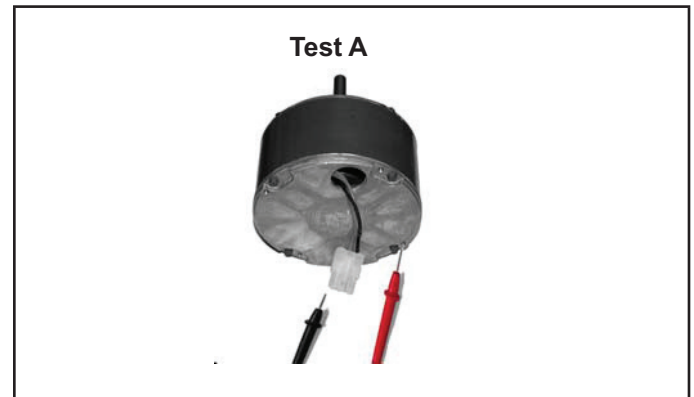

FIGURE 11

TEST B

Use an ohmmeter to measure the motor phase-to-phase resistance by checking these combinations of the the 3-pin motor plug. For the purpose of this test, start at either end of the connector as lead 1.

- 1 - The lead-to-lead resistance across any two leads should be less than 20 ohms.
- 2 - Each lead-to-lead resistance should be the same.

If the measured resistance is greater than 20 ohms, replace the motor and control module.

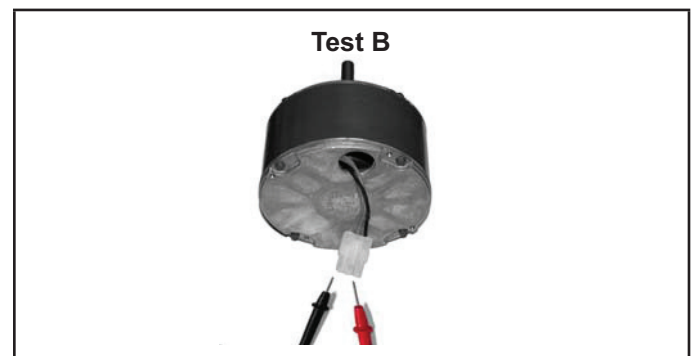

FIGURE 12

C- Heating Components

1. Ignitor

The SureLight® ignitor is made of durable silicon nitride. Ignitor longevity is enhanced by controlling voltage to the ignitor. The integrated control provides a regulated 120 volts to the ignitor for a consistent ignition and long ignitor life. Ohm value should be 39 to 70. See Figure 13 for ignitor location and Figure 14 for ignitor check out.

NOTE - The SL280UHNV furnace contains electronic components that are polarity sensitive. Make sure that the furnace is wired correctly and is properly grounded.

2. Flame Sensor

A flame sensor is located on the top of the air gas plenum. See Figure 13. The sensor can be removed for service without removing the burner. During operation, flame is sensed by current passed through the flame and sensing electrode. The SureLight control allows the gas valve to remain open as long as flame signal is sensed. To check flame sense signal use the push-button found on the integrated control and go to Field Test Mode. The menu will display the flame signal. See Table 15 for flame signal.

TABLE 15
Flame Signal in Microamps

Normal	Low	Drop Out
2.6 or greater	2.5 or less	1.1

3. Gas Valve

The valve (Figure 16) is internally redundant to assure safety shut-off. If the gas valve must be replaced, the same type valve must be used.

24VAC terminals and gas control knob are located on the valve. A wire harness connects the terminals from the gas valve to the electronic ignition control. 24V applied to the terminals energizes the valve. Inlet and outlet pressure taps are located on the valve. A regulator adjustment screw is located on the valve.

4. Thermal Switch

The auto-reset switch is located on the front of the intake air elbow. The switch will safely shut the unit down if excessive temperatures are detected. See Figure 13. When the switch senses excessive temperature, the circuit breaks and the ignition control immediately stops ignition and closes the gas valve.

5. Burner and Orifice

Burners are factory set and require no adjustment. Always operate the unit with air gas plenum in place. The burner has one orifice located between the gas valve and the air intake assembly (Figure 13). To check or replace the orifice remove the intake air screen, coupling and intake air elbow. Using a 5/8" socket, go through the elbow and unscrew the gas orifice. The burner uses an orifice (see Table 16) that is precisely matched to the burner input. The burner can be removed for service. If burner has been removed, it is critical to replace all gaskets.

TABLE 16
Gas Orifices

Unit Input	Orifice Size (0 - 4500 ft)
060	0.0595
080	0.0689
100	0.0810

6. Primary Limit Control (S10)

The primary limit (S10) is located in the heating vestibule panel. When excess heat is sensed in the heat exchanger, the limit will open. If the limit is open, the furnace control energizes the supply air blower and closes the gas valve. The limit automatically resets when unit temperature returns to normal. The switch must reset within three minutes or the SureLight control will go into Watch guard for one hour. The switch is factory set and cannot be adjusted. The switch may have a different set point for each unit model number. See Lennox Repair Parts Handbook if limit switch must be replaced.

HEATING COMPONENTS

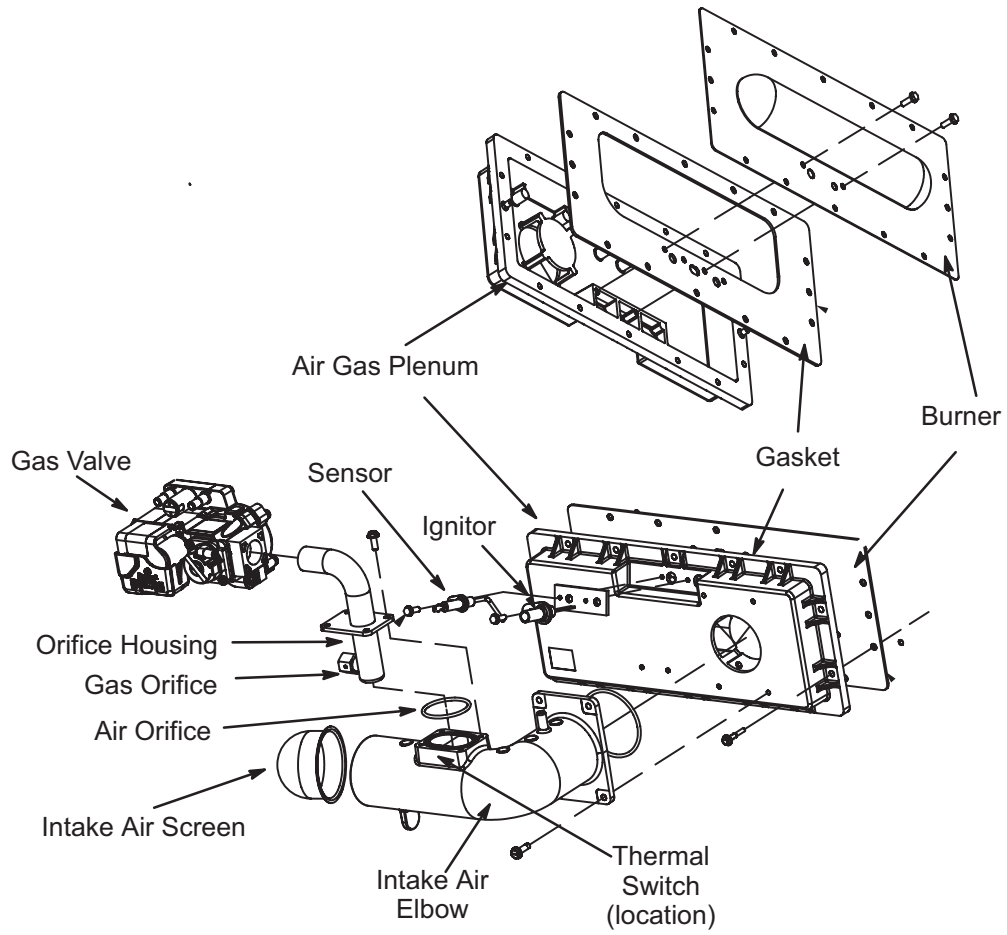
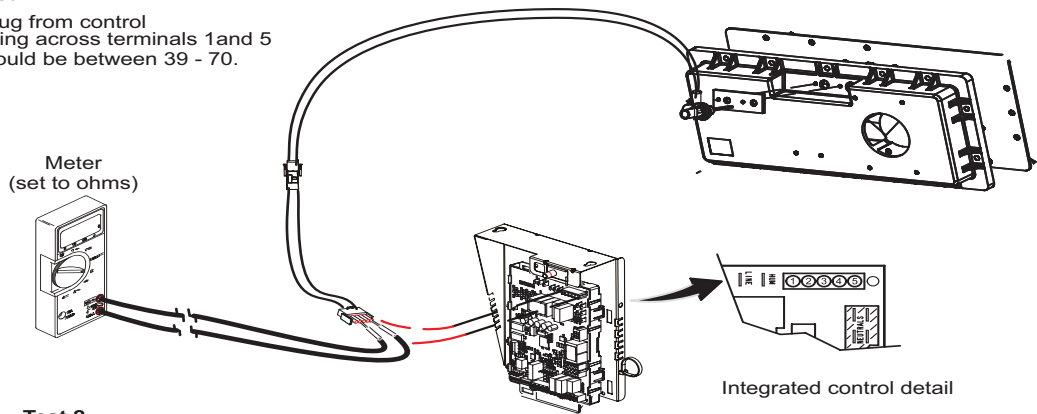

FIGURE 13

SL280UHNV Ignitor Check Out (exploded view for clarity)

Test 1

Remove 5-pin plug from control
Check ohms reading across terminals 1 and 5
Ohm value should be between 39 - 70.



Test 2

Separate the 2-pin jack plug near the manifold and check resistance of the ignitor. If the reading is correct, then there is a problem with the wiring between the jack plug and control. If the reading is not correct the issue is the ignitor.

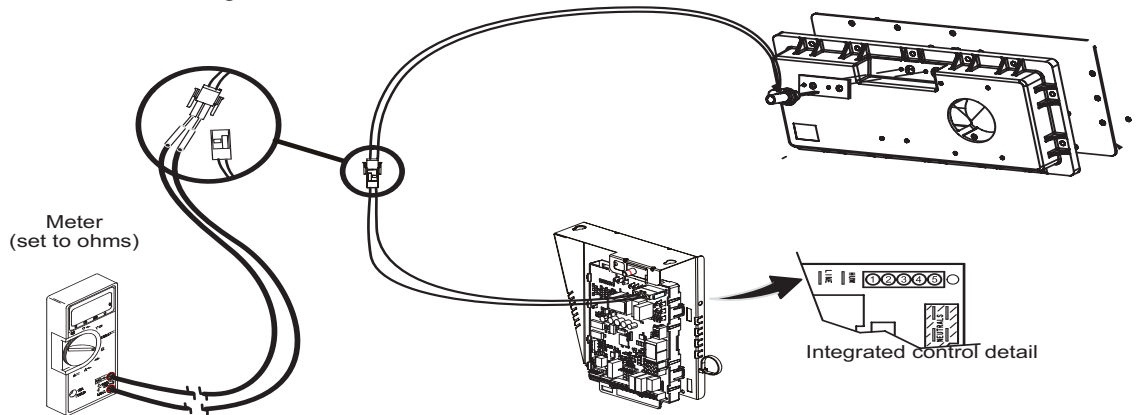

Test 3

Insert meter probes into the terminals 1 and 5. (Use small diameter probes in order to not damage plug). Check voltage during 20 second warm up period. Voltage should read 120 volts \pm 10%. If voltage is above these values, check for correct supply voltage to furnace.

Meter
(set to AC volts)

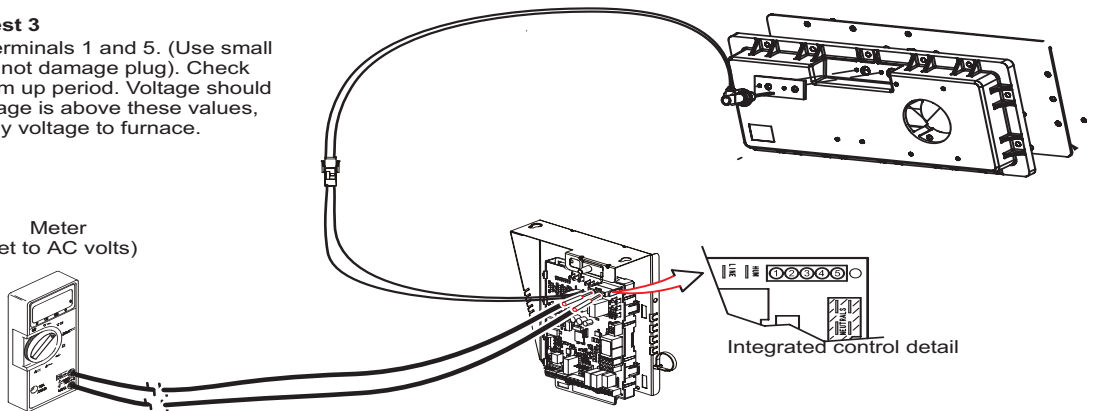

FIGURE 14

7. Combustion Air Inducer (B6)

All SL280UHNV units use a two-stage combustion air inducer to move air through the burners and heat exchanger during heating operation. The blower uses a 120VAC motor. The motor operates during all heating operation and is controlled by integrated control control A92. The inducer also operates for 15 seconds before burner ignition (prepurge) and for 5 seconds after the gas valve closes (postpurge). The inducer operates on low speed during firststage heat, then switches to high speed for second stage heat.

8. Combustion Air Inducer Prove Switch (S18)

SL280UHNV series units are equipped with a single combustion air proving switch (first and second stage) located near the gas valve. See Figure 15. The switch is a single-pole single-throw proving switch electrically connected to the integrated control. The purpose of the switch is to prevent burner operation if the combustion air inducer is not operating or if the flue becomes obstructed.

On heat demand (first or second stage) the switch senses that the combustion air inducer is operating. It closes a circuit to the integrated control when pressure inside the combustion air inducer decreases to a certain set point. The set point is 0.20" for low heat and high heat and the same for all SL280UHNV models. The pressure sensed by the switch is negative relative to atmospheric pressure. If the flue becomes obstructed during operation, the switch senses a loss of pressure difference and opens the circuit to the furnace control and gas valve.

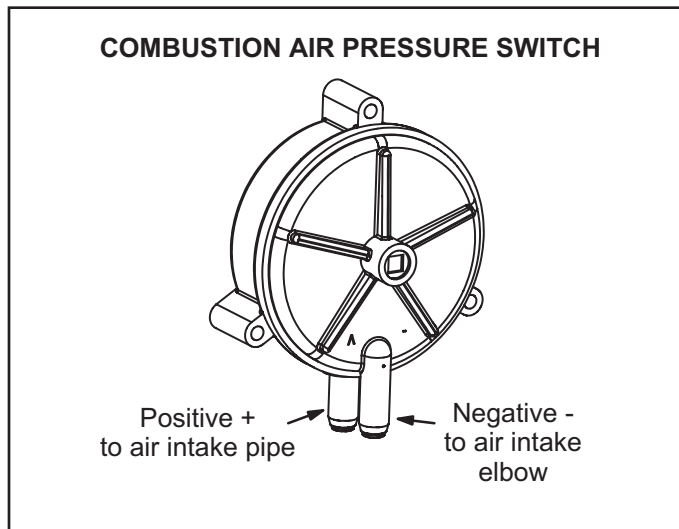

FIGURE 15

NOTE - The switch is factory set and is not field adjustable. It is a safety shut-down control in the furnace and must not be by-passed for any reason. If switch is closed or bypassed, the control will not initiate ignition at start up.

II-Placement and Installation

Make sure unit is installed in accordance with installation instructions and applicable codes.

III-Start-Up

A-Preliminary and Seasonal Checks

- 1 - Inspect electrical wiring, both field and factory installed for loose connections. Tighten as required.
- 2 - Check voltage at disconnect switch. Voltage must be within range listed on the nameplate. If not, consult the power company and have voltage condition corrected before starting unit.

B-Heating Start-Up

⚠ WARNING

Shock and burn hazard.

SL280UHNV units are equipped with a hot surface ignition system. Do not attempt to light manually.

- 1 - STOP! Read the safety information at the beginning of this section.
- 2 - Set the thermostat to the lowest setting.
- 3 - Turn off all electrical power to the unit.
- 4 - This furnace is equipped with an ignition device which automatically lights the burners. Do not try to light the burners by hand.
- 5 - Remove the access panel.
- 6 - Turn switch on gas valve to OFF. Do not force. See figure 16.
- 7 - Wait five minutes to clear out any gas. If you then smell gas, STOP! Immediately call your gas supplier from a neighbor's phone. Follow the gas supplier's instructions. If you do not smell gas go to next step.

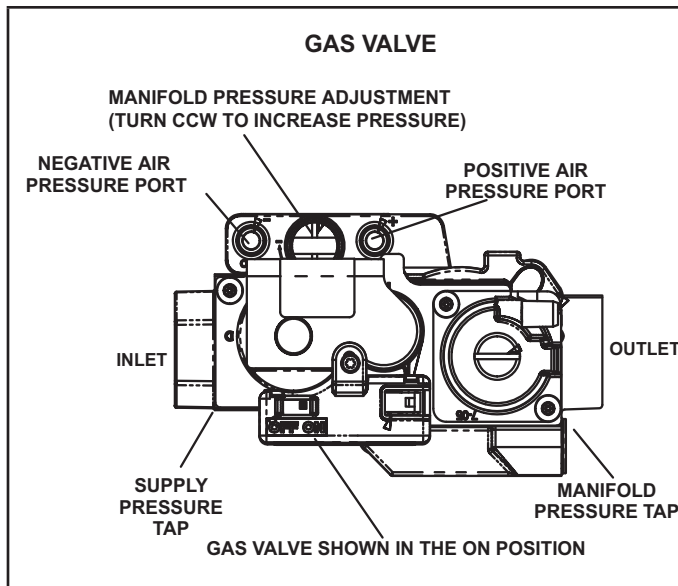

FIGURE 16

- 8 - Move switch on gas valve to ON. Do not force. See Figure 16.
- 9 - Replace the access panel.
- 10 - Turn on all electrical power to the unit.
- 11 - Set the thermostat to desired setting.

NOTE - When unit is initially started, steps 1 through 11 may need to be repeated to purge air from gas line.

Turning Off Gas To Unit

- 1 - Set thermostat to lowest setting.
- 2 - Turn off all electrical power to unit if service is to be performed.
- 3 - Remove access panel.
- 4 - Move switch on valve to OFF. Do not force.
- 5 - Replace access panel.

Failure To Operate

If the unit fails to operate, check the following:

- 1 - Is the thermostat calling for heat?
- 2 - Are access panels securely in place?
- 3 - Is the main disconnect switch closed?
- 4 - Is there a blown fuse or tripped circuit breaker?
- 5 - Is the filter dirty or plugged? Dirty or plugged filters will cause the limit control to shut the unit off.
- 6 - Is gas turned on at the meter?
- 7 - Is the manual main shut-off valve open?
- 8 - Is the internal manual shut-off valve open?
- 9 - Is the unit ignition system in lock out? If the unit locks out again, call the service technician to inspect the unit for blockages.

10 - Is pressure switch closed? Obstructed flue will cause unit to shut off at pressure switch. Check flue and outlet for blockages.

11 - Are flame rollout switches tripped? If flame rollout switches are tripped, call the service technician for inspection.

C-Safety or Emergency Shutdown

Turn off unit power. Close manual and main gas valves.

D-Extended Period Shutdown

Turn off thermostat or set to "UNOCCUPIED" mode. Close all gas valves (both internal and external to unit) to guarantee no gas leak into combustion chamber. Turn off power to unit. All access panels and covers must be in place and secured.

IV-Heating System Service Checks

A-CSA Certification

All units are CSA design certified without modifications. Refer to the SL280UHNV Installation Instruction.

B-Gas Piping

⚠ CAUTION

If a flexible gas connector is required or allowed by the authority that has jurisdiction, black iron pipe shall be installed at the gas valve and extend outside the furnace cabinet.

⚠ WARNING

Do not over torque (800 in-lbs) or under torque (350 in-lbs) when attaching the gas piping to the gas valve.

Gas supply piping should not allow more than 0.5"W.C. drop in pressure between gas meter and unit. Supply gas pipe must not be smaller than unit gas connection.

Compounds used on gas piping threaded joints should be resistant to action of liquefied petroleum gases.

C-Testing Gas Piping

⚠ IMPORTANT

In case emergency shutdown is required, turn off the main shut-off valve and disconnect the main power to unit. These controls should be properly labeled by the installer.

When pressure testing gas lines, the gas valve must be disconnected and isolated. Gas valves can be damaged if subjected to more than 0.5 psig (14" W.C.). See Figure 17. If the pressure is greater than 0.5psig (14"W.C.), use the manual shut-off valve before pressure testing to isolate furnace from gas supply.

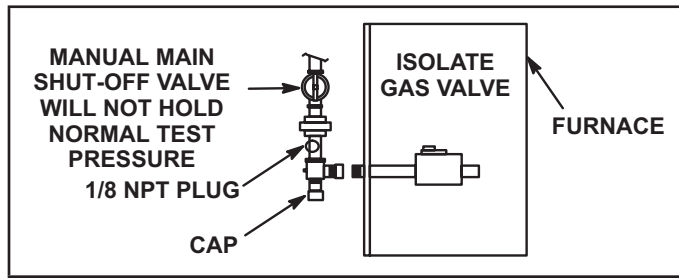

FIGURE 17

When checking piping connections for gas leaks, use preferred means. Kitchen detergents can cause harmful corrosion on various metals used in gas piping. Use of a specialty Gas Leak Detector is strongly recommended. It is available through Lennox under part number 31B2001. See Corp. 8411-L10, for further details.

Do not use matches, candles, flame or any other source of ignition to check for gas leaks.

D-Testing Gas Supply Pressure

A port on the inlet side of the gas valve provides access to the supply pressure tap. See figure 16. Loosen the screw and connect a manometer to measure supply pressure. The minimum supply line pressure is 4.5" - 13.0" w.c. for natural and 11.0 - 13.0" wc for LP/Propane. Tighten after measurements have been taken.

⚠ IMPORTANT

For safety, connect a shut-off valve between the manometer and the gas tap to permit shut off of gas pressure to the manometer.

E- Proper Gas Flow (Approximate)

Furnace should operate at least 5 minutes before checking gas flow. Determine time in seconds for **two** revolutions of gas through the meter. (Two revolutions assures a more accurate time.) **Divide by two** and compare to time in Table 17 below.

NOTE- To obtain accurate reading, shut off all other gas appliances connected to meter.

TABLE 17

GAS METER CLOCKING CHART

SL280N Unit	Seconds for One Revolution			
	Natural		LP Propane	
	1 cu ft Dial	2 cu ft Dial	1 cu ft Dial	2 cu ft Dial
060	60	120	150	300
080	45	90	112	224
100	36	72	N/A	N/A
Natural-1000 btu/cu ft - Propane - 2500btu/cu ft				

F-Rate Check

Manifold Pressure Measurement

To correctly measure manifold pressure, follow the steps below:

- 1 - Remove the threaded plug from the outlet side of the gas valve and install a field-provided barbed fitting. Connect measuring device "+" connection to barbed fitting to measure manifold pressure.
- 2 - Start unit on low heat and allow 15 minutes for unit to reach steady state.
- 3 - After allowing unit to stabilize for 15 minutes, record manifold pressure and compare to value given in Table 18.
- 4 - Repeat on high heat.
- 5 - Shut unit off and remove manometer as soon as an accurate reading has been obtained. Take care to remove barbed fitting and replace threaded plug.
- 6 - Start unit and perform leak check. Seal leaks if found.

TABLE 18

Manifold in. wc.

Unit	LP Con. Kit	High Fire Nat	Low Fire Nat	High Fire LP	Low Fire LP
060	20P40	3.0 - 3.8	1.3 - 1.7	3.4 - 3.8	1.5 - 1.9
080	20P41			N/A	N/A
100	N/A				

G-Proper Combustion

Furnace should operate minimum 15 minutes with correct gas flow rate before checking combustion. Take combustion sample beyond the flue outlet. Table 19 shows acceptable combustion for ALL SL280UHNV models. The maximum carbon monoxide reading should not exceed 100 ppm.

TABLE 19

Firing Rate	CO ₂ % For Nat	CO ₂ % For LP/Propane
High Fire	6.0 - 7.8	7.5 - 9.0
Low Fire		

V-Typical Operating Characteristics

A-Blower Operation and Adjustment

- 1 - Blower operation is dependent on thermostat control system.
- 2 - Generally, blower operation is set at thermostat subbase fan switch. With fan switch in ON position, blower operates continuously. With fan switch in AUTO position, blower cycles with demand or runs continuously while heating or cooling circuit cycles.
- 3 - Depending on the type of indoor thermostat, blower and entire unit will be off when the system switch is in OFF position.

B-Temperature Rise Figure 18

Temperature rise for SL280UHNV units depends on unit input, blower speed, blower horsepower and static pressure as marked on the unit rating plate. The blower speed must be set for unit operation within the range of "TEMP. RISE °F" listed on the unit rating plate.

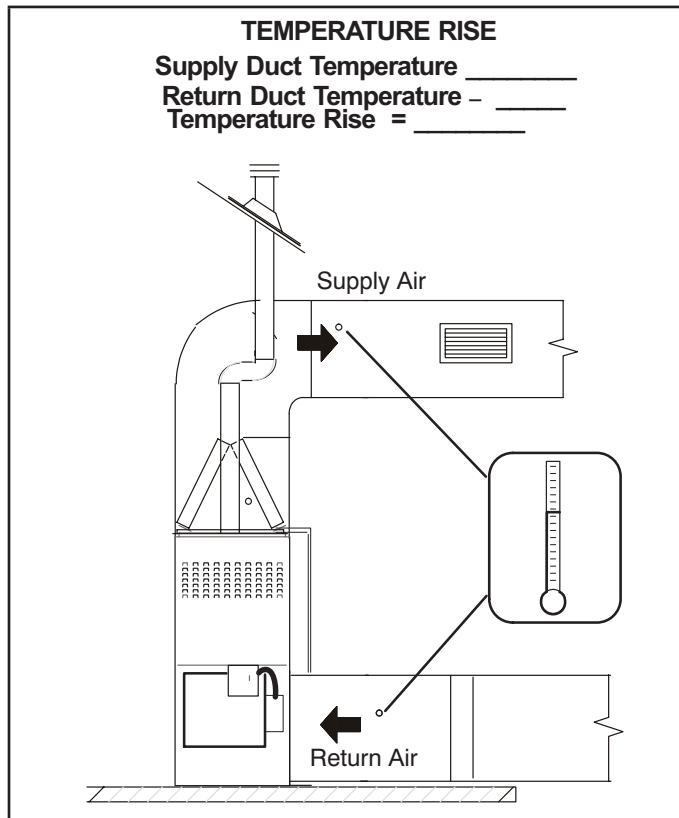

C-External Static Pressure

- 1 - Tap locations shown in Figure 19.
- 2 - Punch a 1/4" diameter hole in supply and return air plenums. Insert manometer hose flush with inside edge of hole or insulation. Seal around the hose with permagum. Connect the zero end of the manometer to the discharge (supply) side of the system. On ducted systems, connect the other end of manometer to the return duct as above.
- 3 - With only the blower motor running and the evaporator coil dry, observe the manometer reading. Adjust blower motor speed to deliver the air desired according to the job requirements. For heating speed external static pressure drop must not be more than 0.5" W.C. For cooling speed external static pressure drop must not be more than 0.8" W.C.
- 4 - Seal the hole when the check is complete.

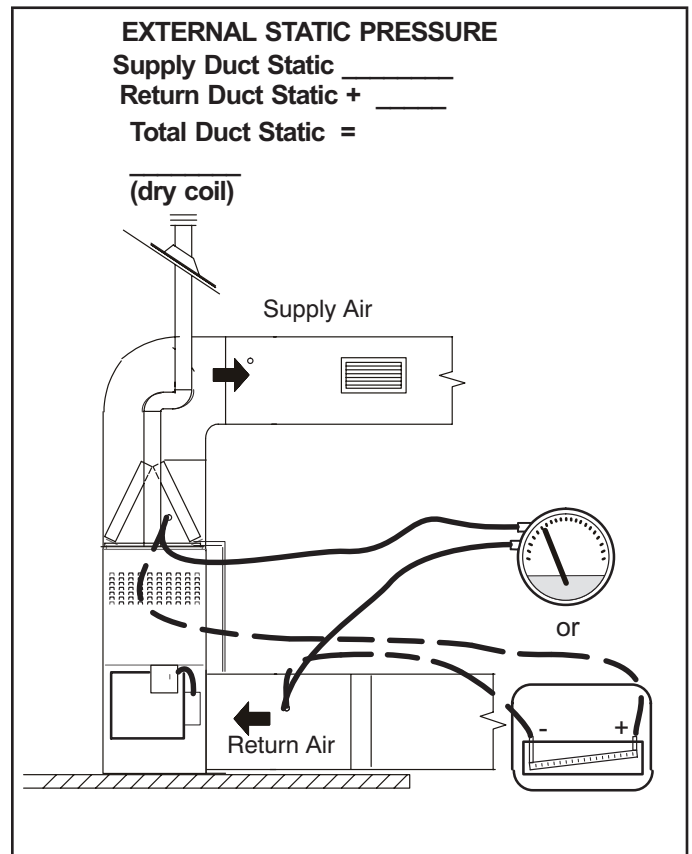

VI-Maintenance

Annual Furnace Maintenance

At the beginning of each heating season, and to comply with the Lennox Limited Warranty, your system should be checked by a licensed professional technician (or equivalent) as follows:

WARNING

Disconnect power before servicing unit..

CAUTION

Label all wires prior to disconnection when servicing controls. Wiring errors can cause improper and dangerous operation. Verify proper operation after servicing.

- 1 - Check wiring for loose connections, voltage at indoor unit and amperage of indoor motor.
- 2 - Check the condition of the belt and shaft bearings if applicable.
- 3 - Inspect all gas pipe and connections for leaks.
- 4 - Check the cleanliness of filters and change if necessary (monthly).

IMPORTANT

If a highefficiency filter is being installed as part of this system to ensure better indoor air quality, the filter must be properly sized. Highefficiency filters have a higher static pressure drop than standardefficiency glass/foam filters. If the pressure drop is too great, system capacity and performance may be reduced. The pressure drop may also cause the limit to trip more frequently during the winter and the indoor coil to freeze in the summer, resulting in an increase in the number of service calls.

Before using any filter with this system, check the specifications provided by the filter manufacturer against the data given in the appropriate Lennox Product Specifications bulletin. Additional information is provided in Service and Application Note ACC002 (August 2000).

WARNING

The blower access panel must be securely in place when the blower and burners are operating. Gas fumes, which could contain carbon monoxide, can be drawn into living space resulting in personal injury or death.

- 5 - Check the condition and cleanliness of burners and heat exchanger and clean if necessary.
- 6 - Check the cleanliness of blower assembly and clean the housing, blower wheel and blower motor if necessary. The blower motors are prelubricated for extended bearing life. No further lubrication is needed.

- 7 - Inspect the combustion air inducer and clean if necessary.
- 8 - Evaluate the heat exchanger integrity by inspecting the heat exchanger per the AHRI heat exchanger inspection procedure. This procedure can be viewed at www.ahrinet.org
- 9 - Ensure sufficient combustion air is available to the furnace. Fresh air grilles and louvers (on the unit and in the room where the furnace is installed) must be properly sized, open and unobstructed to provide combustion air.
- 10 - Inspect the furnace venting system to make sure it is in place, structurally sound, and without holes, corrosion, or blockage. Vent system must be free and clear of obstructions and must slope upward away from the furnace. Vent system should be installed per the National Fuel Gas Code
- 11 - Inspect the furnace return air duct connection to ensure the duct is sealed to the furnace. Check for air leaks on supply and return ducts and seal where necessary.
- 12 - Check the condition of the furnace cabinet insulation and repair if necessary.
- 13 - Perform a complete combustion analysis during the furnace inspection to ensure proper combustion and operation. Consult Service Literature for proper combustion values.
- 14 - Verify operation of CO detectors and replace batteries as required.

Perform a general system test. Turn on the furnace to check operating functions such as the start-up and shut-off operation.

- 1 - Check the operation of the ignition system, inspect and clean flame sensor. Check microamps before and after. Check controls and safety devices (gas valve, flame sensor, temperature limits). Consult Service Manual for proper operating range. Thermal Limits should be checked by restricting airflow and not disconnecting the indoor blower. For additional details, please see Service and Application Note H049.
- 2 - Verify that system total static pressure and airflow settings are within specific operating parameters.
- 3 - Clock gas meter to ensure that the unit is operating at the specified firing rate. Check the supply pressure and the manifold pressure. On two-stage gas furnaces check the manifold pressure on high fire and low fire. If manifold pressure adjustment is necessary, consult the Service Literature for unit specific information on adjusting gas pressure. Not all gas valves are adjustable. Verify correct temperature rise.

A-Heat Exchanger and Burners Figure 20

Cleaning the Heat Exchanger and Burners

NOTE - Use papers or protective covering in front of the furnace during cleaning.

- 1 - Turn off both electrical and gas power supplies to furnace.
- 2 - Remove flue pipe and top cap (some applications top cap can remain) from the unit.
- 3 - Label the wires from gas valve, thermal switch, primary limit switch and make-up box then disconnect them.
- 4 - Remove the screws that secure the combustion air inducer to the collector box.
- 5 - Disconnect gas supply piping. Remove the screw securing the air fuel plenum and remove along with the air intake assembly as one component.
- 6 - Remove screws from both sides, top and bottom of vestibule panel.
- 7 - Remove heat exchanger. It may be necessary to spread cabinet side to allow more room. If so, remove five screws from the left side or right side of cabinet. See Figure 21.
- 8 - Back wash using steam. Begin from the burner opening on each tube. Steam must not exceed 275°F.
- 9 - To clean burner and intake debris screen, run a vacuum cleaner over the face of burners. Visually inspect inside the burner. Remove any blockage. Figure 20 shows burner detail. Replace gasket between burner plate and air fuel plenum then re-install burner plate.
- 10 - To clean the combustion air inducer visually inspect and using a wire brush clean where necessary. Use compressed air to clean off debris and any rust.
- 11 - Reinstall heat exchanger in vestibule. (Replace the five screws in the cabinet from step 7 if removed).
- 12 - Reinstall the air fuel plenum and air intake assembly. Make note of the numbered sequence when re-installing the air fuel plenum. Follow the sequence as shown in Figure 20. Torque screws to a maximum of 100 ± 5 in - lbs. and a minimum 60 in - lbs.
- 13 - Re-install the combustion air inducer assembly. Make note to re-install all screws. Failure to replace all screws may cause leaks. Reconnect all wires.
- 14 - Reconnect top cap and vent pipe to combustion air inducer outlet.
- 15 - Reconnect gas supply piping.
- 16 - Turn on power and gas supply to unit.
- 17 - Set thermostat and check for proper operation.
- 18 - Check all piping connections, factory and field, for gas leaks. Use a leak detecting solution or other preferred means.

CAUTION

Some soaps used for leak detection are corrosive to certain metals. Carefully rinse piping thoroughly after leak test has been completed. Do not use matches, candles, flame or other sources of ignition to check for gas leaks.

- 19 - If a leak is detected, shut gas and electricity off and repair leak.
- 20 - Repeat steps 18 and 19 until no leaks are detected.
- 21 - Replace access panel

Heat Exchanger and Burner Assembly Removal

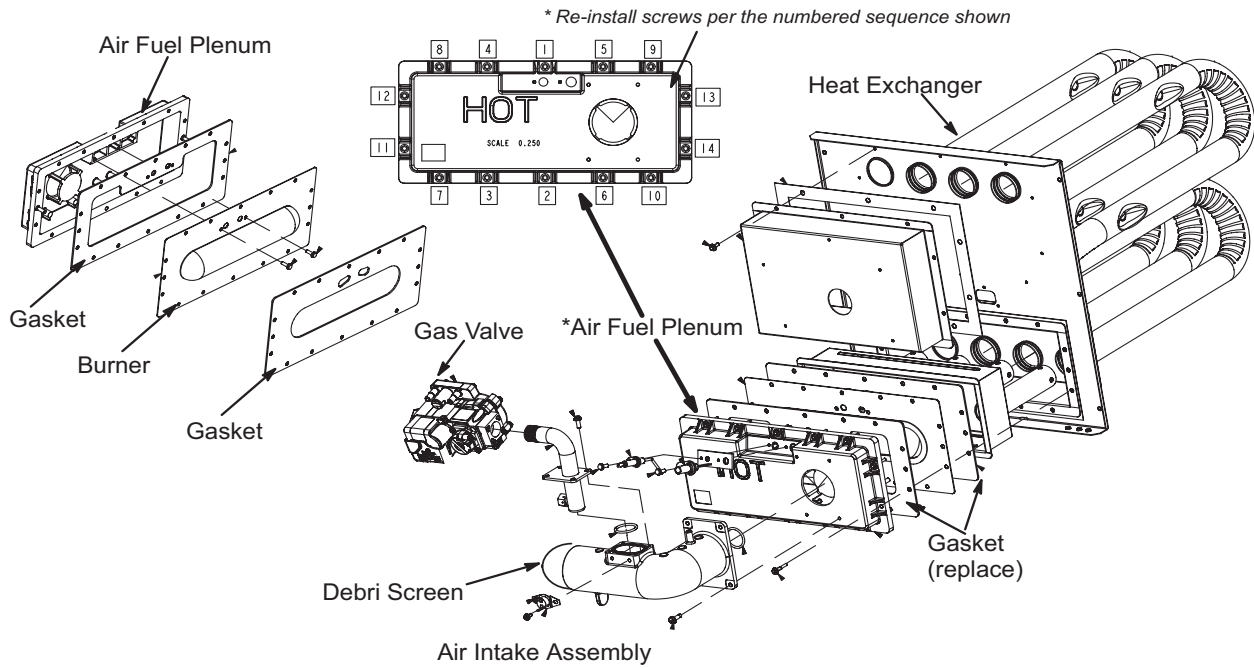

FIGURE 20

Remove 5 screws if necessary
(cabinet for reference only)

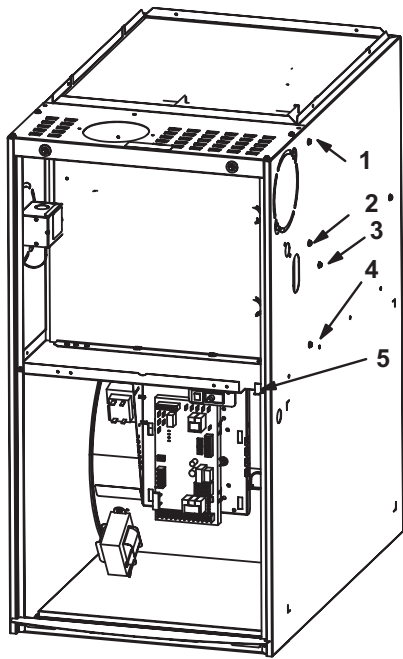
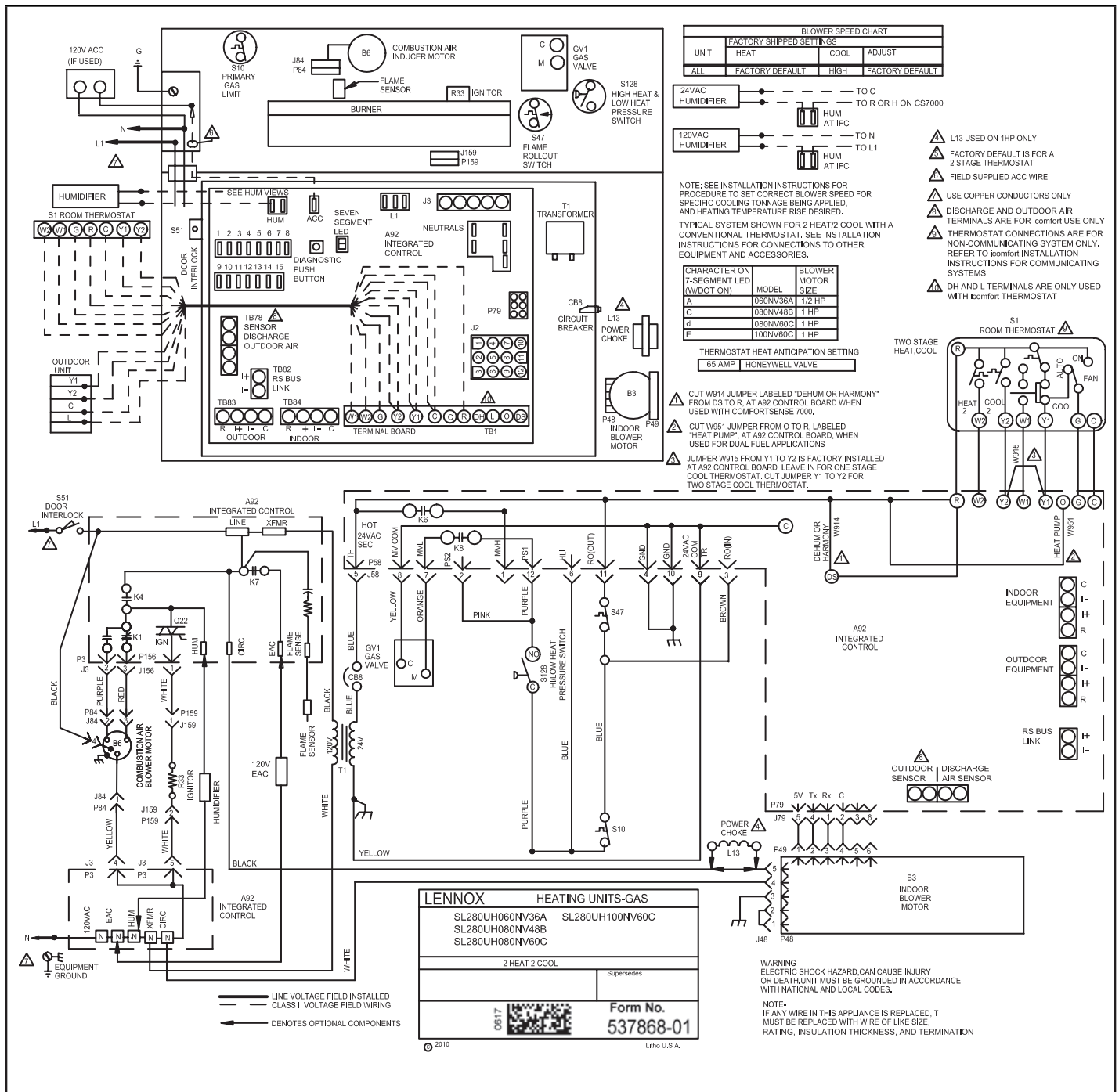

FIGURE 21



VII- Wiring and Sequence of Operation

When there is a call for heat, the iComfort® enabled integrated control runs a self check. The control checks for S10 primary limit and S47 rollout switch normally closed contacts. The control also checks for S102 high heat and S128 low heat prove switch normally open contacts. Once self check is complete and all safety switches are operational, heat call can continue.

NOTE - The ignition control thermostat selection DIP switch is factory-set in the "TWO-STAGE" position.

⚠ WARNING

Electric Shock Hazard. Can cause injury or death. Unit must be properly grounded in accordance with national and local codes.

⚠ WARNING

Fire Hazard. Use of aluminum wire with this product may result in a fire, causing property damage, severe injury or death. Use copper wire only with this product.

CAUTION

Failure to use properly sized wiring and circuit breaker may result in property damage. Size wiring and circuit breaker(s) per Product Specifications bulletin (EHB) and unit rating plate.

Applications Using a Two-Stage Thermostat

A - Heating Sequence -- Integrated Control Thermostat Selection DIP Switch 1 OFF in "Two-Stage" Position (Factory Setting)

- 1 - On a call for heat, thermostat first-stage contacts close sending a signal to the integrated control. The integrated control runs a self-diagnostic program and checks high temperature limit for normally closed contacts and pressure switch for normally open contacts. The combustion air inducer is energized at low speed.
- 2 - Once the control receives a signal that the pressure switch has closed, the combustion air inducer begins a 15-second pre-purge in low speed.
- 3 - After the pre-purge is complete, a 20-second initial ignitor warm-up period begins. The combustion air inducer continues to operate at low speed.
- 4 - After the 20-second warm-up period has ended, the gas valve is energized on low fire and ignition occurs. At the same time, the control module sends a signal to begin an indoor blower 30-second ON-delay. When the delay ends, the indoor blower motor is energized on the low fire heating speed, the HUM contacts close energizing the humidifier and 120V ACC terminal is energized. The furnace will continue this operation as long as the thermostat has a first-stage heating demand.

NOTE - *If the indoor thermostat is set on CONTINUOUS FAN ON mode, the furnace will light on high fire (second-stage) for 60 seconds to improve heat exchanger warm up. After 60 second warm-up period, furnace will switch to low fire (first-stage).*

- 5 - If second-stage heat is required, the thermostat second-stage heat contacts close and send a signal to the integrated control. The integrated control initiates a 30-second second-stage recognition delay.
- 6 - At the end of the recognition delay, the integrated control energizes the combustion air inducer at high speed. The gas valve is energized on high fire and the indoor blower motor is energized for operation at the high fire heating speed.
- 7 - When the demand for high fire heat is satisfied, the combustion air inducer is switched to the low-fire heating speed and the gas valve reduces to low fire. The low-fire gas valve continues operation. The indoor blower motor is switched to the low-fire heating speed.

- 8 - When the thermostat demand for low-fire heat is satisfied, the gas valve is de-energized and the field-selected indoor blower off delay begins. The combustion air inducer begins a 5-second post-purge period.
- 9 - When the combustion air post-purge period is complete, the inducer, the HUM contacts as well as the 120V ACC terminals are de-energized. The indoor blower is de-energized at the end of the off delay.

Applications Using A Single-Stage Thermostat

B - Heating Sequence -- Integrated Control Thermostat Selection DIP Switch 1 ON in "Single-Stage" Position

NOTE - *In these applications, two-stage heat will be initiated by the integrated control if heating demand has not been satisfied after the field adjustable period (7 or 12 minutes).*

- 1 - On a call for heat, thermostat first-stage contacts close sending a signal to the integrated control. The integrated control runs a self-diagnostic program and checks high temperature limit switches for normally closed contacts and pressure switches for normally open contacts. The combustion air inducer is energized at low speed.
- 2 - Once the control receives a signal that the pressure switch has closed, the combustion air inducer begins a 15-second pre-purge in low speed.
- 3 - After the pre-purge is complete, a 20-second initial ignitor warm-up period begins. The combustion air inducer continues to operate at low speed.
- 4 - After the 20-second warm-up period has ended, the gas valve is energized on low fire (first stage) and ignition occurs. At the same time, the control module sends a signal to begin an indoor blower 30-second ON-delay. When the delay ends, the indoor blower motor is energized on the low fire heating speed and the HUM contacts are energized. The integrated control also initiates a second-stage on delay (factory-set at 7 minutes; adjustable to 12 minutes).
- 5 - If the heating demand continues beyond the secondstage on delay, the integrated control energizes the combustion air inducer at high speed. The gas valve is energized on high fire and the indoor blower motor is energized for operation at the high fire heating speed.
- 6 - When the thermostat heating demand is satisfied, the combustion air inducer begins a 5-second low speed post-purge. The field-selected indoor blower off delay begins. The indoor blower operates at the low-fire heating speed.
- 7 - When the combustion air post-purge period is complete, the inducer, the HUM contacts as well as the 120V ACC terminals are de-energized. The indoor blower is de-energized at the end of the off delay.

Communicating Enabled Furnace and Non-Communicating Outdoor Unit

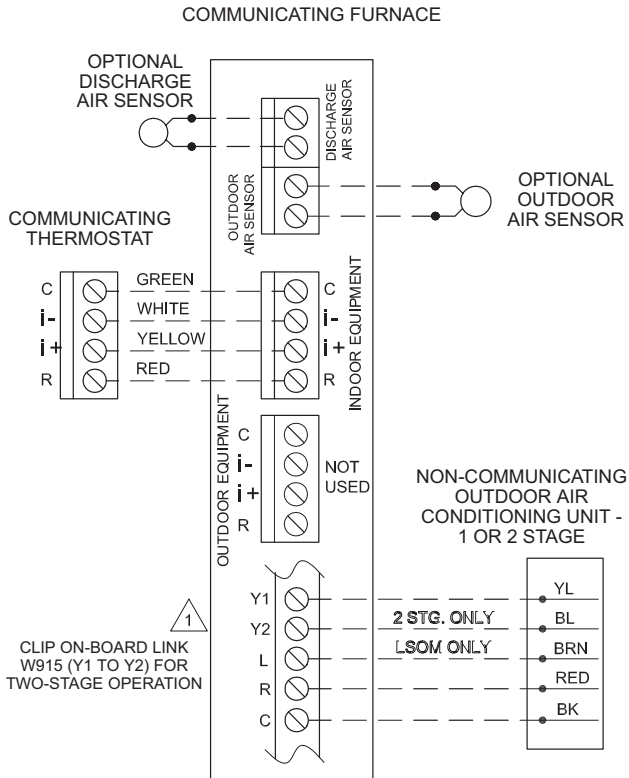

Communicating Enabled Furnace and Communicating Enabled Outdoor Unit

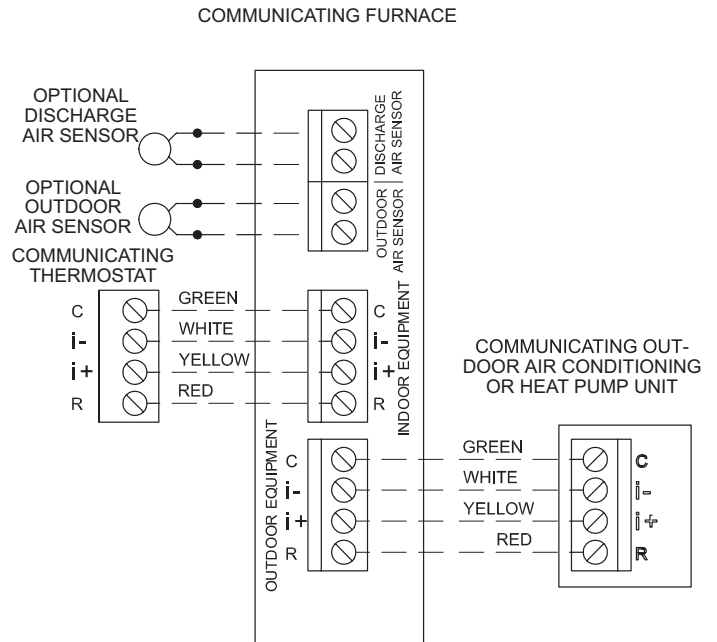

Communicating systems four thermostat wires between the thermostat and the furnace/air handler control and four wires between the outdoor unit and the furnace/air handler control. When a thermostat cable with more than four wires is used, the extra wires must be properly connected to avoid electrical noise. The wires must not be left disconnected.

Use wire nuts to bundle the four unused wires at each end of the cable. A single wire should then be connected to the indoor unit end of the wire bundle and attached to the "C" terminals as shown below.

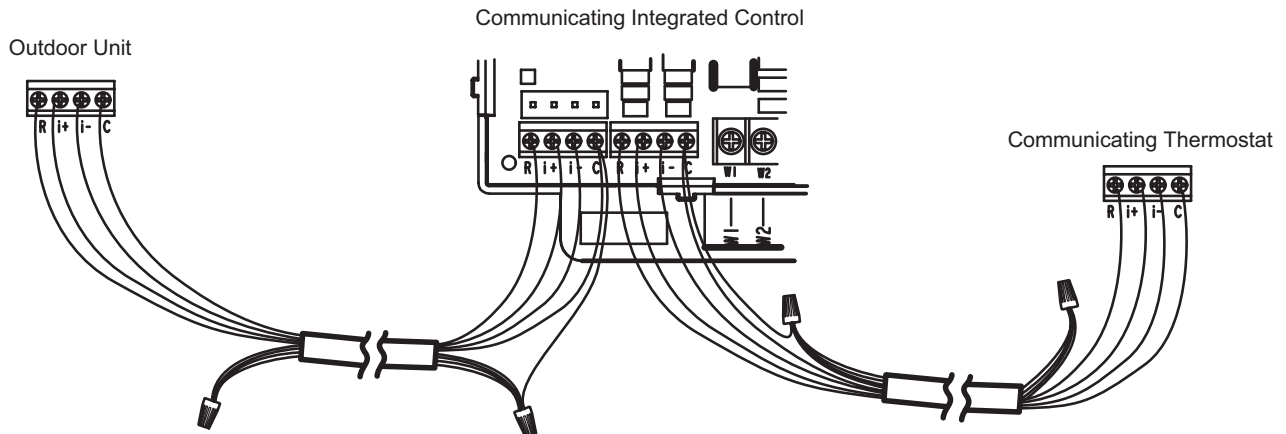

Optional Accessories for use with Communicating System

NOTE: COMMUNICATING THERMOSTAT SENSES HUMIDITY & CONTROLS HUM CONTACTS TO CYCLE HUMIDIFIER BASED ON DEMAND. NO OTHER CONTROL OR HUMIDISTAT REQUIRED.

OPTIONAL OUTDOOR AIR SENSOR FOR USE WITH HUMIDIFIER (IF NOT ALREADY IN THE SYSTEM FOR OTHER FUNCTIONS. BUILT INTO ALL COMMUNICATING ENABLED OUTDOOR UNITS).

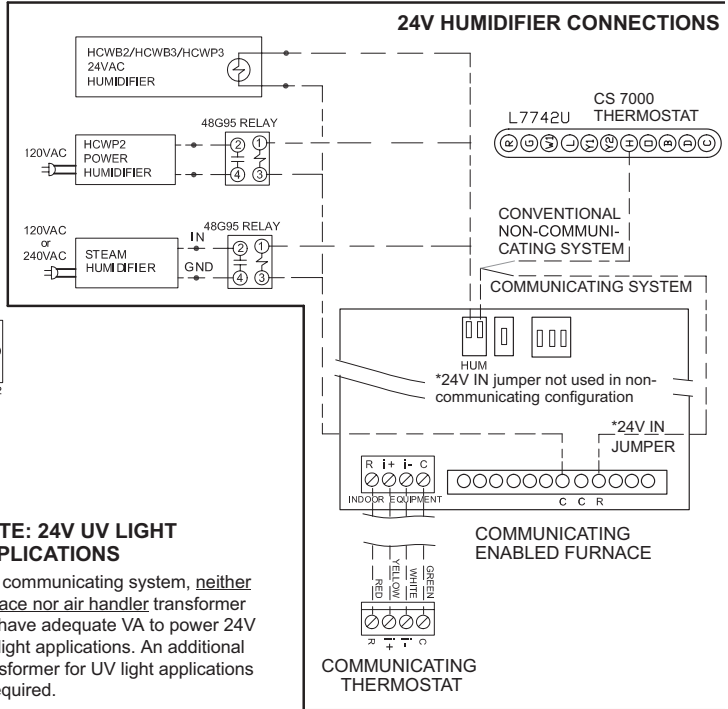
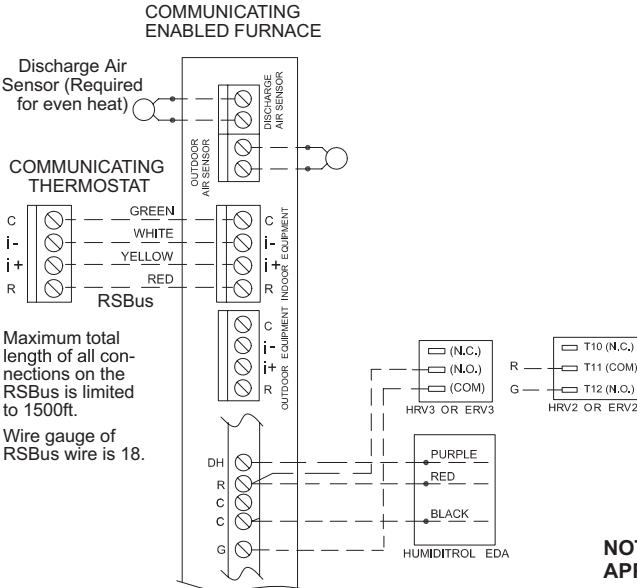
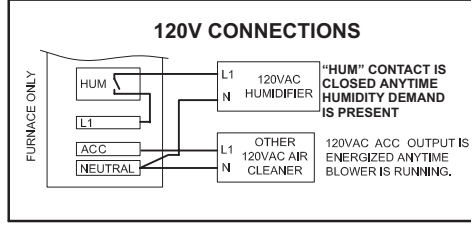

NOTE: 24V UV LIGHT APPLICATIONS
In a communicating system, neither furnace nor air handler transformer will have adequate VA to power 24V UV light applications. An additional transformer for UV light applications is required.

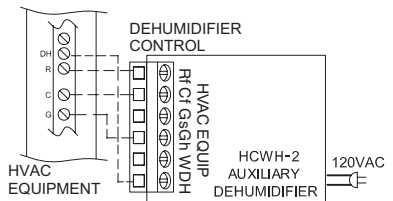
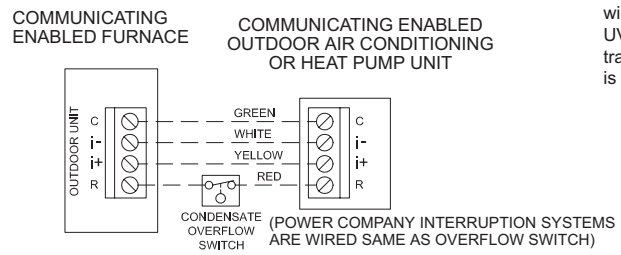

HEPA BYPASS FILTER X2680 HEPA INTERLOCK KIT

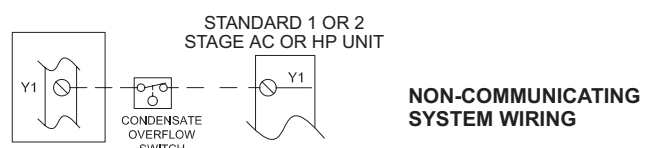
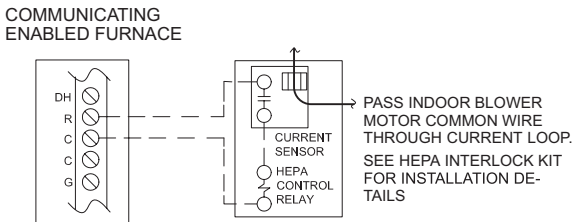

LVCS VENTILATION CONTROL SYSTEM

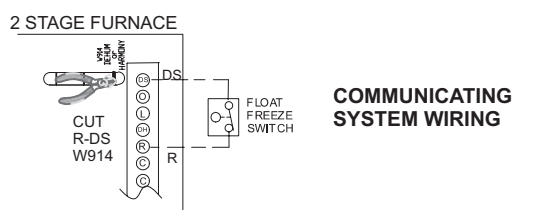
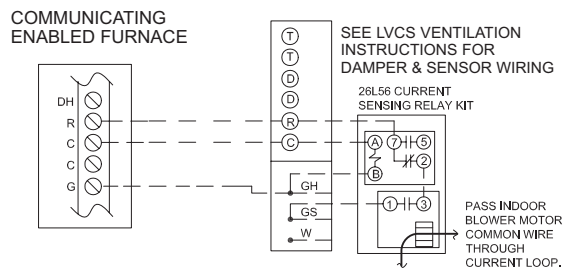

VIII- Field Wiring With Conventional Thermostat

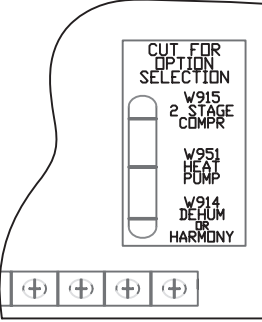
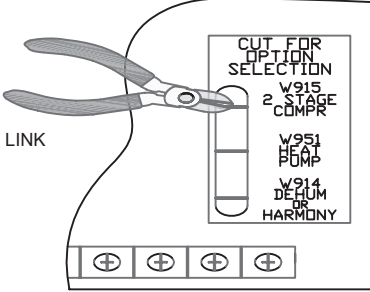
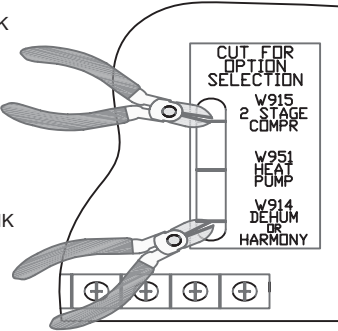
Thermostat	DIP Switch Settings and On-Board Links		Wiring Connections																														
	DIP Switch 1 Thermostat Heating Stages	On Board Links Must Be Cut To Select System Options																															
1 Heat / 1 Cool <i>NOTE - Use DIP switch 2 to set second-stage heat ON delay. OFF-7 minutes. ON-12 minutes.</i>	ON	DO NOT CUT ANY ON-BOARD LINKS 	<table border="0"> <tr> <td>S1 T'STAT</td> <td>FURNACE TERM. STRIP</td> <td>OUTDOOR UNIT</td> </tr> <tr> <td></td> <td>(DS)</td> <td></td> </tr> <tr> <td>(W2)</td> <td>(W2)</td> <td></td> </tr> <tr> <td>(W1)-----</td> <td>(W1)</td> <td></td> </tr> <tr> <td>(R)-----</td> <td>(R)</td> <td>*----- (R)</td> </tr> <tr> <td>(G)-----</td> <td>(G)</td> <td></td> </tr> <tr> <td>(C)-----</td> <td>(C)</td> <td>----- (C)</td> </tr> <tr> <td></td> <td>(Y2)</td> <td></td> </tr> <tr> <td>(Y)-----</td> <td>(Y1)</td> <td>----- (Y1)</td> </tr> <tr> <td></td> <td>(O)</td> <td></td> </tr> </table>	S1 T'STAT	FURNACE TERM. STRIP	OUTDOOR UNIT		(DS)		(W2)	(W2)		(W1)-----	(W1)		(R)-----	(R)	*----- (R)	(G)-----	(G)		(C)-----	(C)	----- (C)		(Y2)		(Y)-----	(Y1)	----- (Y1)		(O)	
S1 T'STAT	FURNACE TERM. STRIP	OUTDOOR UNIT																															
	(DS)																																
(W2)	(W2)																																
(W1)-----	(W1)																																
(R)-----	(R)	*----- (R)																															
(G)-----	(G)																																
(C)-----	(C)	----- (C)																															
	(Y2)																																
(Y)-----	(Y1)	----- (Y1)																															
	(O)																																
1 Heat / 2 Cool <i>NOTE - Use DIP switch 2 to set second-stage heat ON delay. OFF-7 minutes. ON-12 minutes.</i>	ON	CUT ON-BOARD LINK W915 2 STAGE COMPR 	<table border="0"> <tr> <td>S1 T'STAT</td> <td>FURNACE TERM. STRIP</td> <td>OUTDOOR UNIT</td> </tr> <tr> <td></td> <td>(DS)</td> <td></td> </tr> <tr> <td></td> <td>(W2)</td> <td></td> </tr> <tr> <td>(W)-----</td> <td>(W1)</td> <td></td> </tr> <tr> <td>(R)-----</td> <td>(R)</td> <td>*----- (R)</td> </tr> <tr> <td>(G)-----</td> <td>(G)</td> <td></td> </tr> <tr> <td>(C)-----</td> <td>(C)</td> <td>----- (C)</td> </tr> <tr> <td>(Y2)-----</td> <td>(Y2)</td> <td>----- (Y2)</td> </tr> <tr> <td>(Y1)-----</td> <td>(Y1)</td> <td>----- (Y1)</td> </tr> <tr> <td></td> <td>(O)</td> <td></td> </tr> </table>	S1 T'STAT	FURNACE TERM. STRIP	OUTDOOR UNIT		(DS)			(W2)		(W)-----	(W1)		(R)-----	(R)	*----- (R)	(G)-----	(G)		(C)-----	(C)	----- (C)	(Y2)-----	(Y2)	----- (Y2)	(Y1)-----	(Y1)	----- (Y1)		(O)	
S1 T'STAT	FURNACE TERM. STRIP	OUTDOOR UNIT																															
	(DS)																																
	(W2)																																
(W)-----	(W1)																																
(R)-----	(R)	*----- (R)																															
(G)-----	(G)																																
(C)-----	(C)	----- (C)																															
(Y2)-----	(Y2)	----- (Y2)																															
(Y1)-----	(Y1)	----- (Y1)																															
	(O)																																
1 Heat / 2 Cool with t'stat with humidity control <i>NOTE - Use DIP switch 2 to set second-stage heat ON delay. OFF-7 minutes. ON-12 minutes.</i>	ON	CUT ON-BOARD LINK W915 2 STAGE COMPR CUT ON-BOARD LINK W914 DEHUM OR HARMONY 	<table border="0"> <tr> <td>S1 T'STAT</td> <td>FURNACE TERM. STRIP</td> <td>OUTDOOR UNIT</td> </tr> <tr> <td>(DS)-----</td> <td>(DS)</td> <td></td> </tr> <tr> <td></td> <td>(W2)</td> <td></td> </tr> <tr> <td>(W1)-----</td> <td>(W1)</td> <td></td> </tr> <tr> <td>(R)-----</td> <td>(R)</td> <td>*----- (R)</td> </tr> <tr> <td>(G)-----</td> <td>(G)</td> <td></td> </tr> <tr> <td>(C)-----</td> <td>(C)</td> <td>----- (C)</td> </tr> <tr> <td>(Y2)-----</td> <td>(Y2)</td> <td>----- (Y2)</td> </tr> <tr> <td>(Y1)-----</td> <td>(Y1)</td> <td>----- (Y1)</td> </tr> <tr> <td></td> <td>(O)</td> <td></td> </tr> </table>	S1 T'STAT	FURNACE TERM. STRIP	OUTDOOR UNIT	(DS)-----	(DS)			(W2)		(W1)-----	(W1)		(R)-----	(R)	*----- (R)	(G)-----	(G)		(C)-----	(C)	----- (C)	(Y2)-----	(Y2)	----- (Y2)	(Y1)-----	(Y1)	----- (Y1)		(O)	
S1 T'STAT	FURNACE TERM. STRIP	OUTDOOR UNIT																															
(DS)-----	(DS)																																
	(W2)																																
(W1)-----	(W1)																																
(R)-----	(R)	*----- (R)																															
(G)-----	(G)																																
(C)-----	(C)	----- (C)																															
(Y2)-----	(Y2)	----- (Y2)																															
(Y1)-----	(Y1)	----- (Y1)																															
	(O)																																

* Not required on all units.

Field Wiring With Conventional Thermostat (Continued)

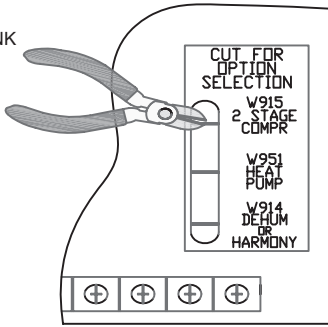
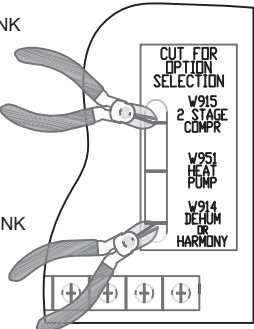
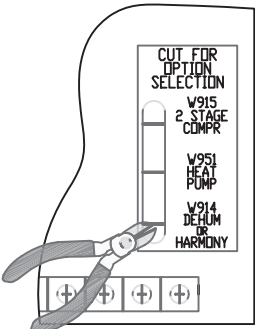
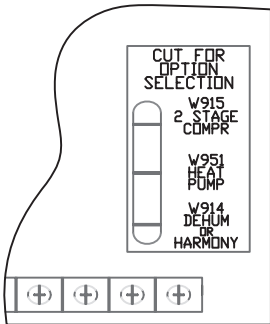
Thermostat	DIP Switch Settings and On-Board Links		Wiring Connections																														
	DIP Switch 1 Thermostat Heating Stages	On Board Links Must Be Cut To Select System Options																															
2 Heat / 2 Cool	OFF	<p>CUT ON-BOARD LINK W915 2 STAGE COMPR</p> 	<table border="0"> <tr> <td>S1 T'STAT</td> <td>FURNACE TERM. STRIP</td> <td>OUTDOOR UNIT</td> </tr> <tr> <td>(W2)-----</td> <td>(W2)</td> <td></td> </tr> <tr> <td>(W1)-----</td> <td>(W1)</td> <td></td> </tr> <tr> <td>(R)-----</td> <td>(R)-----*</td> <td>(R)</td> </tr> <tr> <td>(G)-----</td> <td>(G)</td> <td></td> </tr> <tr> <td>(C)-----</td> <td>(C)-----</td> <td>(C)</td> </tr> <tr> <td>(Y2)-----</td> <td>(Y2)-----</td> <td>(Y2)</td> </tr> <tr> <td>(Y1)-----</td> <td>(Y1)-----</td> <td>(Y1)</td> </tr> <tr> <td></td> <td>(O)</td> <td></td> </tr> </table>	S1 T'STAT	FURNACE TERM. STRIP	OUTDOOR UNIT	(W2)-----	(W2)		(W1)-----	(W1)		(R)-----	(R)-----*	(R)	(G)-----	(G)		(C)-----	(C)-----	(C)	(Y2)-----	(Y2)-----	(Y2)	(Y1)-----	(Y1)-----	(Y1)		(O)				
S1 T'STAT	FURNACE TERM. STRIP	OUTDOOR UNIT																															
(W2)-----	(W2)																																
(W1)-----	(W1)																																
(R)-----	(R)-----*	(R)																															
(G)-----	(G)																																
(C)-----	(C)-----	(C)																															
(Y2)-----	(Y2)-----	(Y2)																															
(Y1)-----	(Y1)-----	(Y1)																															
	(O)																																
2 Heat / 2 Cool with t'stat with humidity control	OFF	<p>CUT ON-BOARD LINK W915 2 STAGE COMPR</p> <p>CUT ON-BOARD LINK W914 DEHUM OR HARMONY</p> 	<table border="0"> <tr> <td>S1 T'STAT</td> <td>FURNACE TERM. STRIP</td> <td>OUTDOOR UNIT</td> </tr> <tr> <td>(D8)-----</td> <td>(D8)</td> <td></td> </tr> <tr> <td>(W2)-----</td> <td>(W2)</td> <td></td> </tr> <tr> <td>(W1)-----</td> <td>(W1)</td> <td></td> </tr> <tr> <td>(R)-----</td> <td>(R)-----*</td> <td>(R)</td> </tr> <tr> <td>(G)-----</td> <td>(G)</td> <td></td> </tr> <tr> <td>(C)-----</td> <td>(C)-----</td> <td>(C)</td> </tr> <tr> <td>(Y2)-----</td> <td>(Y2)-----</td> <td>(Y2)</td> </tr> <tr> <td>(Y1)-----</td> <td>(Y1)-----</td> <td>(Y1)</td> </tr> <tr> <td></td> <td>(O)</td> <td></td> </tr> </table>	S1 T'STAT	FURNACE TERM. STRIP	OUTDOOR UNIT	(D8)-----	(D8)		(W2)-----	(W2)		(W1)-----	(W1)		(R)-----	(R)-----*	(R)	(G)-----	(G)		(C)-----	(C)-----	(C)	(Y2)-----	(Y2)-----	(Y2)	(Y1)-----	(Y1)-----	(Y1)		(O)	
S1 T'STAT	FURNACE TERM. STRIP	OUTDOOR UNIT																															
(D8)-----	(D8)																																
(W2)-----	(W2)																																
(W1)-----	(W1)																																
(R)-----	(R)-----*	(R)																															
(G)-----	(G)																																
(C)-----	(C)-----	(C)																															
(Y2)-----	(Y2)-----	(Y2)																															
(Y1)-----	(Y1)-----	(Y1)																															
	(O)																																
2 Heat / 1 Cool with t'stat with humidity control	OFF	<p>CUT ON-BOARD LINK W914 DEHUM OR HARMONY</p> 	<table border="0"> <tr> <td>S1 T'STAT</td> <td>FURNACE TERM. STRIP</td> <td>OUTDOOR UNIT</td> </tr> <tr> <td>(D8)-----</td> <td>(D8)</td> <td></td> </tr> <tr> <td>(W2)-----</td> <td>(W2)</td> <td></td> </tr> <tr> <td>(W1)-----</td> <td>(W1)</td> <td></td> </tr> <tr> <td>(R)-----</td> <td>(R)-----*</td> <td>(R)</td> </tr> <tr> <td>(G)-----</td> <td>(G)</td> <td></td> </tr> <tr> <td>(C)-----</td> <td>(C)-----</td> <td>(C)</td> </tr> <tr> <td>(Y1)-----</td> <td>(Y1)-----</td> <td>(Y1)</td> </tr> <tr> <td></td> <td>(O)</td> <td></td> </tr> </table>	S1 T'STAT	FURNACE TERM. STRIP	OUTDOOR UNIT	(D8)-----	(D8)		(W2)-----	(W2)		(W1)-----	(W1)		(R)-----	(R)-----*	(R)	(G)-----	(G)		(C)-----	(C)-----	(C)	(Y1)-----	(Y1)-----	(Y1)		(O)				
S1 T'STAT	FURNACE TERM. STRIP	OUTDOOR UNIT																															
(D8)-----	(D8)																																
(W2)-----	(W2)																																
(W1)-----	(W1)																																
(R)-----	(R)-----*	(R)																															
(G)-----	(G)																																
(C)-----	(C)-----	(C)																															
(Y1)-----	(Y1)-----	(Y1)																															
	(O)																																
2 Heat / 1 Cool	OFF	<p>DO NOT CUT ANY ON-BOARD LINKS</p> 	<table border="0"> <tr> <td>S1 T'STAT</td> <td>FURNACE TERM. STRIP</td> <td>OUTDOOR UNIT</td> </tr> <tr> <td>(W2)-----</td> <td>(W2)</td> <td></td> </tr> <tr> <td>(W1)-----</td> <td>(W1)</td> <td></td> </tr> <tr> <td>(R)-----</td> <td>(R)-----*</td> <td>(R)</td> </tr> <tr> <td>(G)-----</td> <td>(G)</td> <td></td> </tr> <tr> <td>(C)-----</td> <td>(C)</td> <td></td> </tr> <tr> <td></td> <td>(Y2)</td> <td></td> </tr> <tr> <td>(Y)-----</td> <td>(Y1)-----</td> <td>(Y1)</td> </tr> <tr> <td></td> <td>(O)</td> <td></td> </tr> </table>	S1 T'STAT	FURNACE TERM. STRIP	OUTDOOR UNIT	(W2)-----	(W2)		(W1)-----	(W1)		(R)-----	(R)-----*	(R)	(G)-----	(G)		(C)-----	(C)			(Y2)		(Y)-----	(Y1)-----	(Y1)		(O)				
S1 T'STAT	FURNACE TERM. STRIP	OUTDOOR UNIT																															
(W2)-----	(W2)																																
(W1)-----	(W1)																																
(R)-----	(R)-----*	(R)																															
(G)-----	(G)																																
(C)-----	(C)																																
	(Y2)																																
(Y)-----	(Y1)-----	(Y1)																															
	(O)																																

* Not required on all units.

Field Wiring With Conventional Thermostat (Continued)

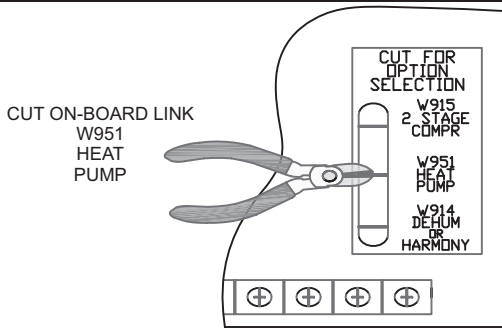
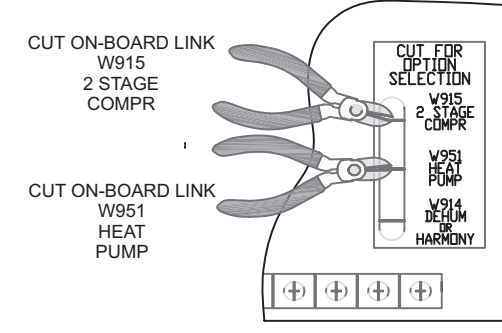
Thermostat	DIP Switch Settings and On-Board Links		Wiring Connections																																													
	DIP Switch 1 Thermostat Heating Stages	On Board Links Must Be Cut To Select System Options																																														
<p>Dual Fuel Single Stage Heat Pump</p> <p>ComfortSense thermostat w/ dual fuel capabilities Capable of 2 stage gas heat control</p>	OFF	 <p>CUT ON-BOARD LINK W951 HEAT PUMP</p> <p>CUT ON-BOARD LINK W914 DEHUM OR HARMONY</p>	<table style="width: 100%; border-collapse: collapse;"> <thead> <tr> <th style="width: 33%;">T'STAT</th> <th style="width: 33%;">FURNACE TERM. STRIP</th> <th style="width: 33%;">HEAT PUMP</th> </tr> </thead> <tbody> <tr><td>R</td><td>R</td><td>R</td></tr> <tr><td>H</td><td></td><td></td></tr> <tr><td>W2</td><td>W2</td><td></td></tr> <tr><td>W1</td><td>W1</td><td>W1</td></tr> <tr><td>O</td><td>O</td><td>O</td></tr> <tr><td>L</td><td></td><td>L</td></tr> <tr><td>Y1</td><td>Y1</td><td>Y</td></tr> <tr><td>Y2</td><td></td><td></td></tr> <tr><td>G</td><td>G</td><td></td></tr> <tr><td>D</td><td>DS</td><td></td></tr> <tr><td>B</td><td>Y2</td><td></td></tr> <tr><td>C</td><td>C</td><td>C</td></tr> <tr><td>T</td><td></td><td></td></tr> <tr><td>T</td><td></td><td>outdoor sensor</td></tr> </tbody> </table>	T'STAT	FURNACE TERM. STRIP	HEAT PUMP	R	R	R	H			W2	W2		W1	W1	W1	O	O	O	L		L	Y1	Y1	Y	Y2			G	G		D	DS		B	Y2		C	C	C	T			T		outdoor sensor
T'STAT	FURNACE TERM. STRIP	HEAT PUMP																																														
R	R	R																																														
H																																																
W2	W2																																															
W1	W1	W1																																														
O	O	O																																														
L		L																																														
Y1	Y1	Y																																														
Y2																																																
G	G																																															
D	DS																																															
B	Y2																																															
C	C	C																																														
T																																																
T		outdoor sensor																																														
<p>Dual Fuel Two Stage Heat Pump</p> <p>ComfortSense thermostat w/ dual fuel capabilities Capable of 2 stage gas heat control</p>	OFF	 <p>CUT ON-BOARD LINK W915 2 STAGE COMPR</p> <p>CUT ON-BOARD LINK W951 HEAT PUMP</p>	<table style="width: 100%; border-collapse: collapse;"> <thead> <tr> <th style="width: 33%;">T'STAT</th> <th style="width: 33%;">FURNACE TERM. STRIP</th> <th style="width: 33%;">HEAT PUMP</th> </tr> </thead> <tbody> <tr><td>R</td><td>R</td><td>R</td></tr> <tr><td>H</td><td></td><td></td></tr> <tr><td>W2</td><td>W2</td><td></td></tr> <tr><td>W1</td><td>W1</td><td>W1</td></tr> <tr><td>O</td><td>O</td><td>O</td></tr> <tr><td>L</td><td></td><td>L</td></tr> <tr><td>Y1</td><td>Y1</td><td>Y1</td></tr> <tr><td>Y2</td><td></td><td>Y2</td></tr> <tr><td>G</td><td>G</td><td></td></tr> <tr><td>D</td><td>DS</td><td></td></tr> <tr><td>B</td><td>Y2</td><td>Y2 out blue</td></tr> <tr><td>C</td><td>C</td><td>C</td></tr> <tr><td>T</td><td></td><td></td></tr> <tr><td>T</td><td></td><td>outdoor sensor</td></tr> </tbody> </table>	T'STAT	FURNACE TERM. STRIP	HEAT PUMP	R	R	R	H			W2	W2		W1	W1	W1	O	O	O	L		L	Y1	Y1	Y1	Y2		Y2	G	G		D	DS		B	Y2	Y2 out blue	C	C	C	T			T		outdoor sensor
T'STAT	FURNACE TERM. STRIP	HEAT PUMP																																														
R	R	R																																														
H																																																
W2	W2																																															
W1	W1	W1																																														
O	O	O																																														
L		L																																														
Y1	Y1	Y1																																														
Y2		Y2																																														
G	G																																															
D	DS																																															
B	Y2	Y2 out blue																																														
C	C	C																																														
T																																																
T		outdoor sensor																																														

* Connect W1 to W1 ONLY if using defrost tempering kit 67M41

NOTE - **Do NOT** make a wire connection between the room thermostat L terminal and the L terminal of the furnace integrated control.

Field Wiring With Conventional Thermostat (Continued)

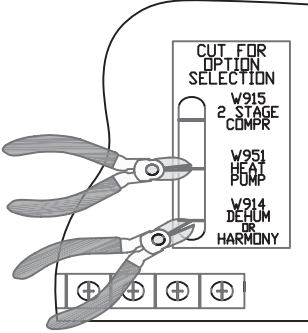
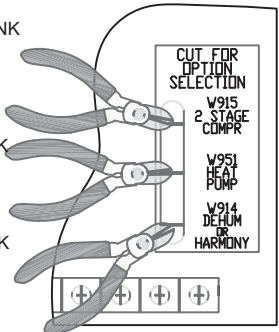
Thermostat	DIP Switch Settings and On-Board Links		Wiring Connections																																													
	DIP Switch 1 Thermostat Heating Stages	On Board Links Must Be Cut To Select System Options																																														
<p>Dual Fuel Single Stage Heat Pump</p> <p>ComfortSense thermostat w/ dual fuel capabilities</p> <p>Capable of 2 stage gas heat control w/dehumidification control</p>	OFF	<p>CUT ON-BOARD LINK W951 HEAT PUMP</p> <p>CUT ON-BOARD LINK W914 DEHUM OR HARMONY</p> 	<table style="width: 100%; border-collapse: collapse;"> <thead> <tr> <th style="width: 33%;">T'STAT</th> <th style="width: 33%;">FURNACE TERM. STRIP</th> <th style="width: 33%;">HEAT PUMP</th> </tr> </thead> <tbody> <tr><td>R</td><td>R</td><td>R</td></tr> <tr><td>H</td><td></td><td></td></tr> <tr><td>W2</td><td>W2</td><td>67M41*</td></tr> <tr><td>W1</td><td>W1</td><td>W1</td></tr> <tr><td>O</td><td>O</td><td>O</td></tr> <tr><td>L</td><td></td><td>L</td></tr> <tr><td>Y1</td><td>Y1</td><td>Y</td></tr> <tr><td>Y2</td><td></td><td></td></tr> <tr><td>G</td><td>G</td><td></td></tr> <tr><td>D</td><td>DS</td><td></td></tr> <tr><td>B</td><td>Y2</td><td></td></tr> <tr><td>C</td><td>C</td><td>C</td></tr> <tr><td>T</td><td></td><td>outdoor sensor</td></tr> <tr><td>T</td><td></td><td></td></tr> </tbody> </table>	T'STAT	FURNACE TERM. STRIP	HEAT PUMP	R	R	R	H			W2	W2	67M41*	W1	W1	W1	O	O	O	L		L	Y1	Y1	Y	Y2			G	G		D	DS		B	Y2		C	C	C	T		outdoor sensor	T		
T'STAT	FURNACE TERM. STRIP	HEAT PUMP																																														
R	R	R																																														
H																																																
W2	W2	67M41*																																														
W1	W1	W1																																														
O	O	O																																														
L		L																																														
Y1	Y1	Y																																														
Y2																																																
G	G																																															
D	DS																																															
B	Y2																																															
C	C	C																																														
T		outdoor sensor																																														
T																																																
<p>Dual Fuel Two Stage Heat Pump</p> <p>ComfortSense thermostat w/ dual fuel capabilities</p> <p>Capable of 2 stage gas heat control w/dehumidification</p>	OFF	<p>CUT ON-BOARD LINK W915 2 STAGE COMPR</p> <p>CUT ON-BOARD LINK W951 HEAT PUMP</p> <p>CUT ON-BOARD LINK W914 DEHUM OR HARMONY</p> 	<table style="width: 100%; border-collapse: collapse;"> <thead> <tr> <th style="width: 33%;">T'STAT</th> <th style="width: 33%;">FURNACE TERM. STRIP</th> <th style="width: 33%;">HEAT PUMP</th> </tr> </thead> <tbody> <tr><td>R</td><td>R</td><td>R</td></tr> <tr><td>H</td><td></td><td></td></tr> <tr><td>W2</td><td>W2</td><td>67M41*</td></tr> <tr><td>W1</td><td>W1</td><td>W1</td></tr> <tr><td>O</td><td>O</td><td>O</td></tr> <tr><td>L</td><td></td><td>L</td></tr> <tr><td>Y1</td><td>Y1</td><td>Y1</td></tr> <tr><td>Y2</td><td></td><td>Y2</td></tr> <tr><td>G</td><td>G</td><td></td></tr> <tr><td>D</td><td>DS</td><td></td></tr> <tr><td>B</td><td>Y2</td><td>Y2 out blue</td></tr> <tr><td>C</td><td>C</td><td>C</td></tr> <tr><td>T</td><td></td><td>outdoor sensor</td></tr> <tr><td>T</td><td></td><td></td></tr> </tbody> </table>	T'STAT	FURNACE TERM. STRIP	HEAT PUMP	R	R	R	H			W2	W2	67M41*	W1	W1	W1	O	O	O	L		L	Y1	Y1	Y1	Y2		Y2	G	G		D	DS		B	Y2	Y2 out blue	C	C	C	T		outdoor sensor	T		
T'STAT	FURNACE TERM. STRIP	HEAT PUMP																																														
R	R	R																																														
H																																																
W2	W2	67M41*																																														
W1	W1	W1																																														
O	O	O																																														
L		L																																														
Y1	Y1	Y1																																														
Y2		Y2																																														
G	G																																															
D	DS																																															
B	Y2	Y2 out blue																																														
C	C	C																																														
T		outdoor sensor																																														
T																																																

* Connect W1 to W1 ONLY if using defrost tempering kit 67M41

NOTE - **Do NOT** make a wire connection between the room thermostat L terminal and the L terminal of the furnace integrated control.

IX- Program Unit Capacity Size Modes

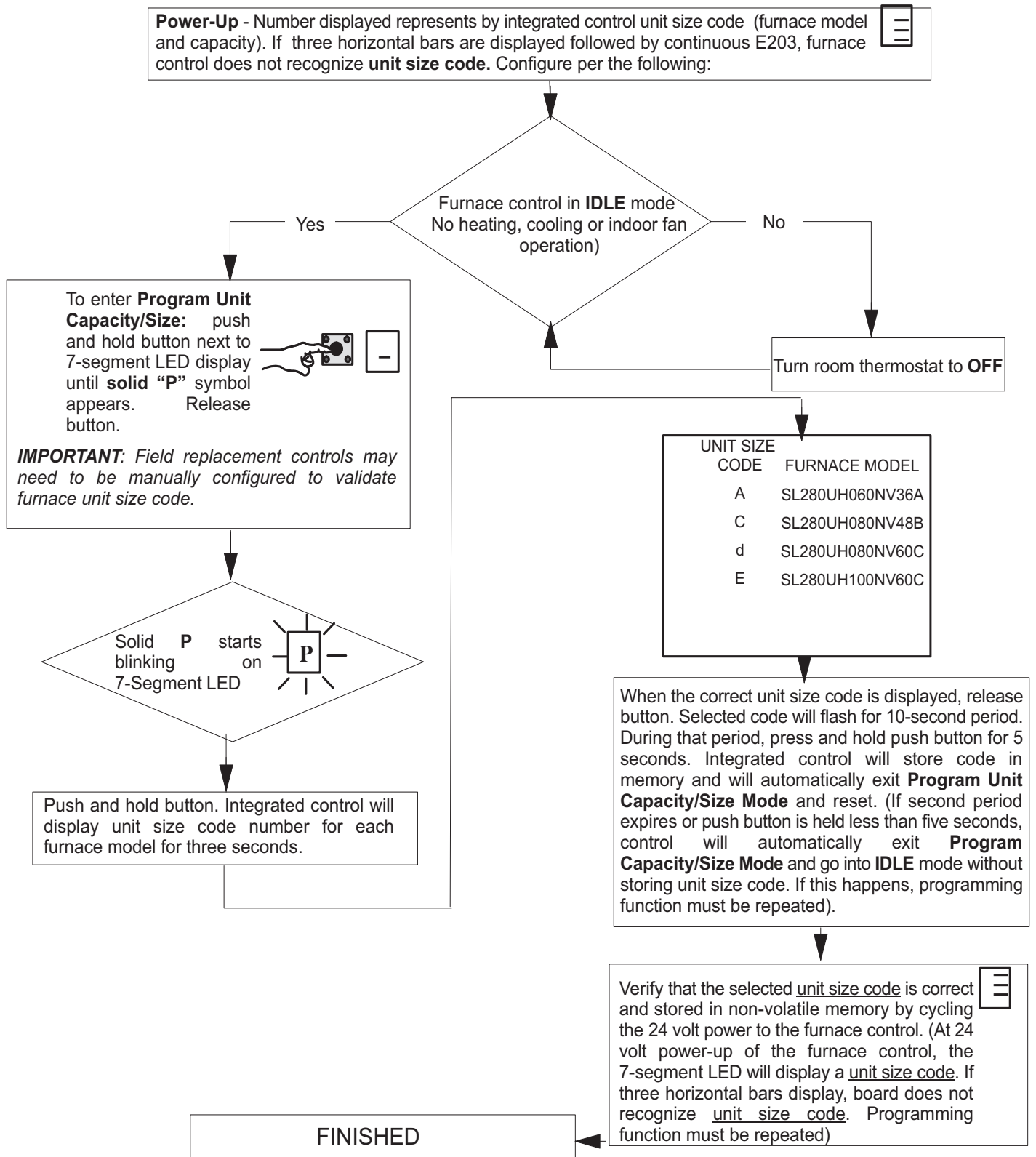

X- Troubleshooting

Heating Sequence of Operation

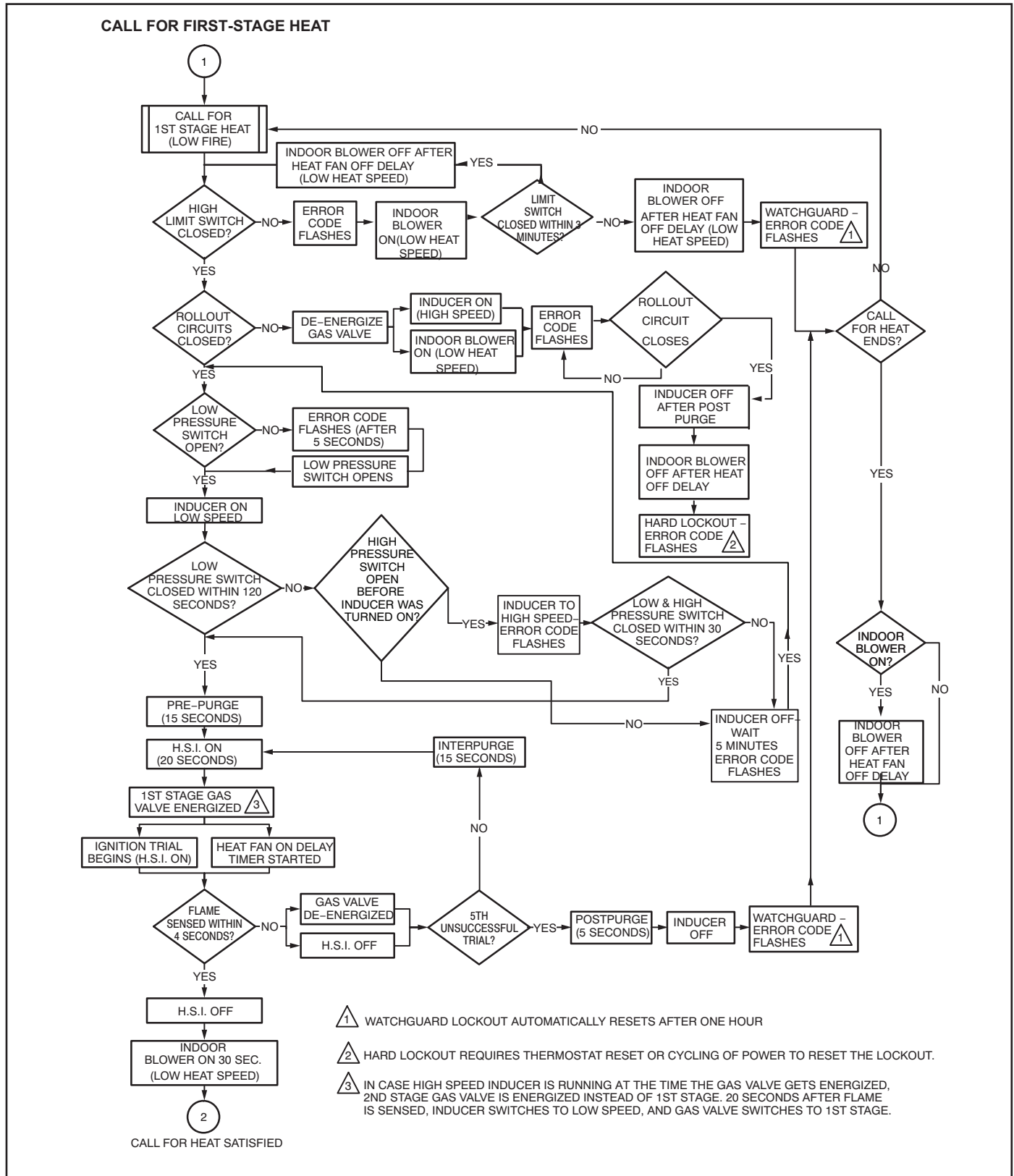

Heating Sequence of Operation (Continued)

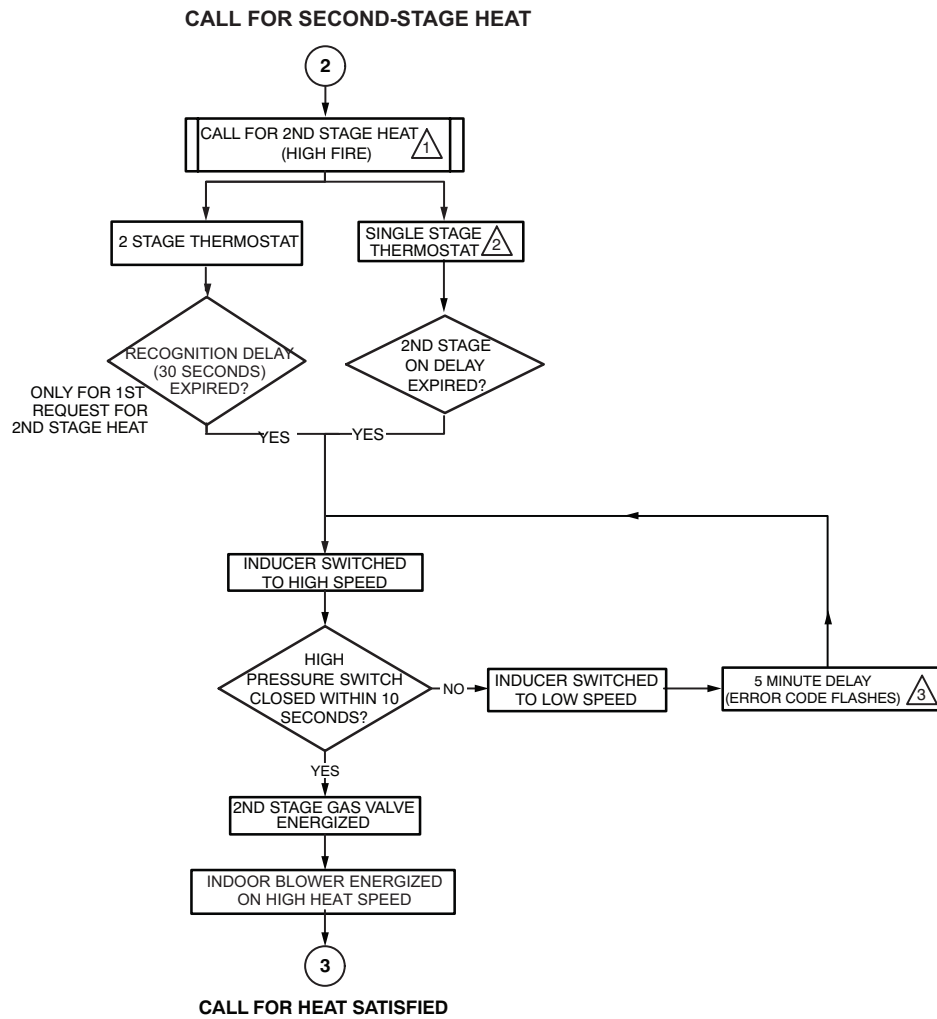

△¹ SYSTEM WILL ALWAYS LIGHT ON LOW FIRE, EVEN IF 2ND STAGE HEAT IS IN PLACE.

△² WHEN USED WITH A SINGLE STAGE THERMOSTAT, SET SW1 TO THE ON POSITION IN DIP SWITCH S4.

△³ IF THE HIGH FIRE PRESSURE SWITCH DOES NOT CLOSE WITHIN 5 ATTEMPTS, THE SYSTEM WILL OPERATE AT LOW FIRE FOR THE REMAINDER OF THE CALL FOR HEAT REQUEST.

Heating Sequence of Operation (Continued)

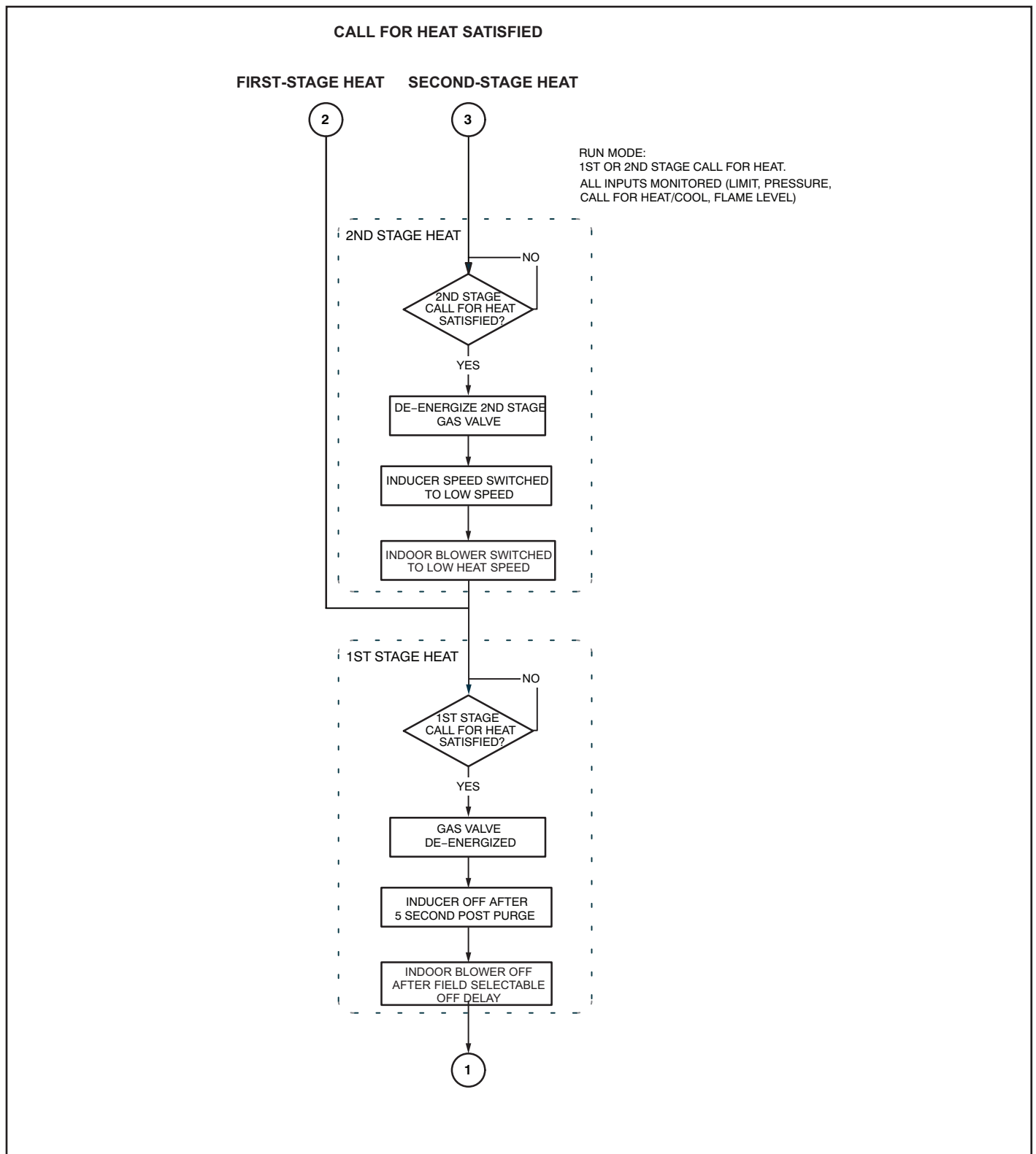

Cooling Sequence of Operation

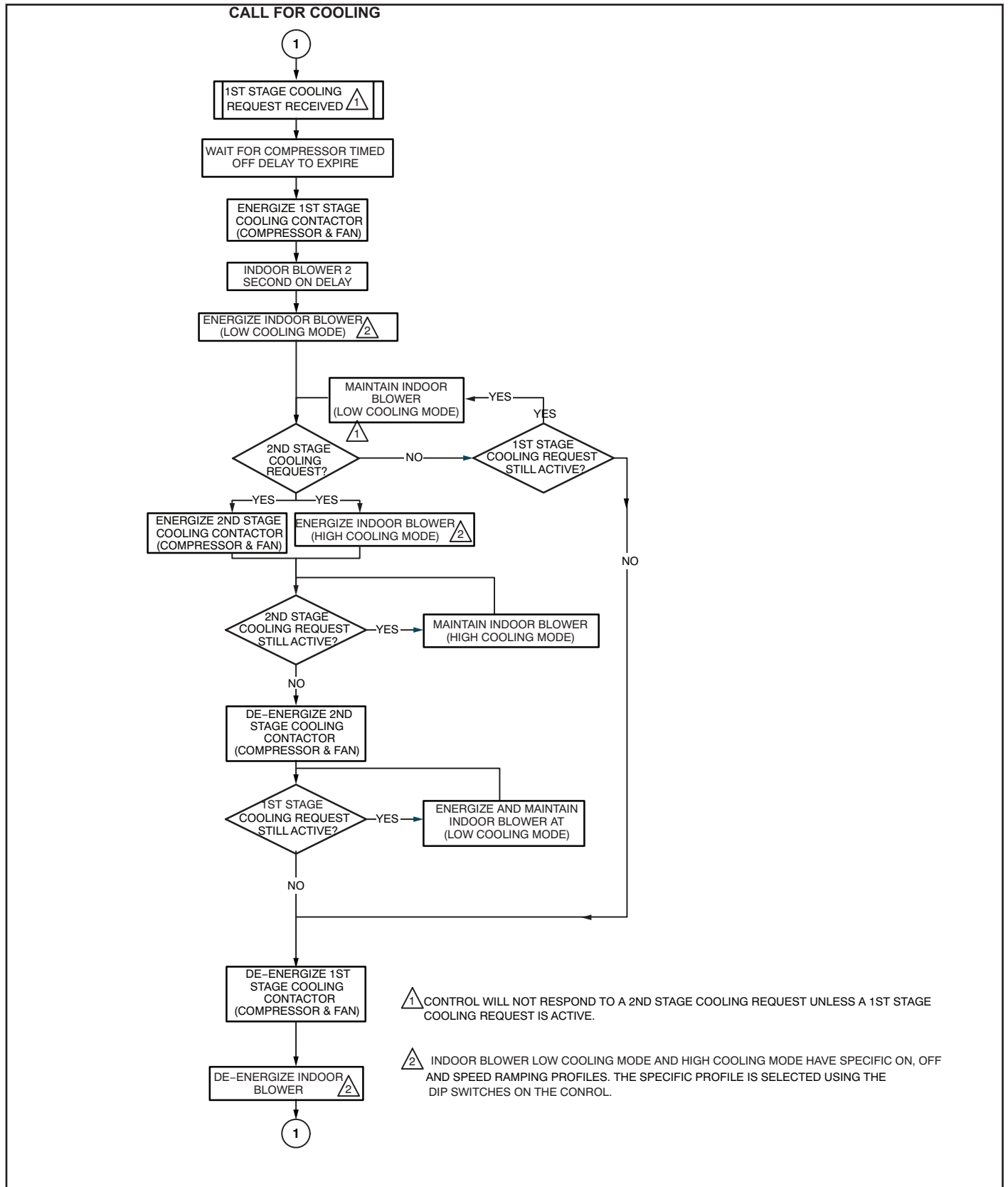

Continuous Fan Sequence of Operation

