



©2017 Lennox Industries Inc.  
Dallas, Texas, USA



# INSTALLATION INSTRUCTIONS

DAVE LENNOX SIGNATURE®  
COLLECTION OIL FURNACE  
UPFLOW AIR DISCHARGE

## SLO185UFV Series Units

OIL UNITS  
507263-01  
06/2017  
Supersedes 12/2016

TP Technical  
Publications  
Litho U.S.A.

**RETAIN THESE INSTRUCTIONS  
FOR FUTURE REFERENCE**

**SLO185UFV SERIES UNITS ARE NOT FOR  
USE IN ZONING APPLICATIONS!**

### **⚠ WARNING**

Improper installation, adjustment, alteration, service, or maintenance can cause injury or property damage. Refer to this manual. For assistance or additional information, consult a licensed professional installer, or equivalent, or service agency.

### **⚠ WARNING**

Do not store or use gasoline or other flammable vapors and liquids in the vicinity of this or any other appliance.

### **⚠ CAUTION**

When venting this appliance, keep vent terminal free of snow, ice and debris.

### **⚠ CAUTION**

As with any mechanical equipment, personal injury can result from contact with sharp sheet metal edges. Be careful when you handle this equipment.

### Table of Contents

General .....	1
Shipping & Packing List .....	1
SLO185UFV Unit Dimensions .....	2
SLO185UFV Unit Parts Arrangement .....	3
SLO185UFV Oil Burner Parts Arrangement .....	3
Requirements .....	4
Combustion & Ventilation Air .....	5
Locate & Level the Unit .....	6
Adjustments .....	7
Venting .....	7
Flue Connections .....	10
Supply & Return Air Plenums .....	10
Oil Supply Line Sizing .....	10
Oil Supply Line & Filter Connections .....	12
Leak Check .....	12
Electrical .....	12
Blower Control .....	16
Unit Start Up & Adjustments .....	19
Service .....	20
Burner Control .....	21
Troubleshooting .....	22

### General

These instructions are intended as a general guide and do not supersede local codes in any way. Only licensed professional technicians, or equivalent, can install and service the Dave Lennox Signature™ Collection SLO185UFV oil furnaces. In Canada, refer to CSA B139 for recommended installation procedures. Consult authorities who have jurisdiction before installation.

### **⚠ CAUTION**

**Never burn garbage or paper in the heating system.  
Never leave papers near or around the unit.**

### Shipping & Packing List

- 1 - Assembled oil furnace
- 1 - Barometric draft control
- 1 - High fire oil nozzle (used to convert to high fire 105 and 141 inputs)

Check the components for shipping damage. If you find any damage, immediately contact the last carrier.



**SLO185UFV Unit Dimensions - Inches (mm)**

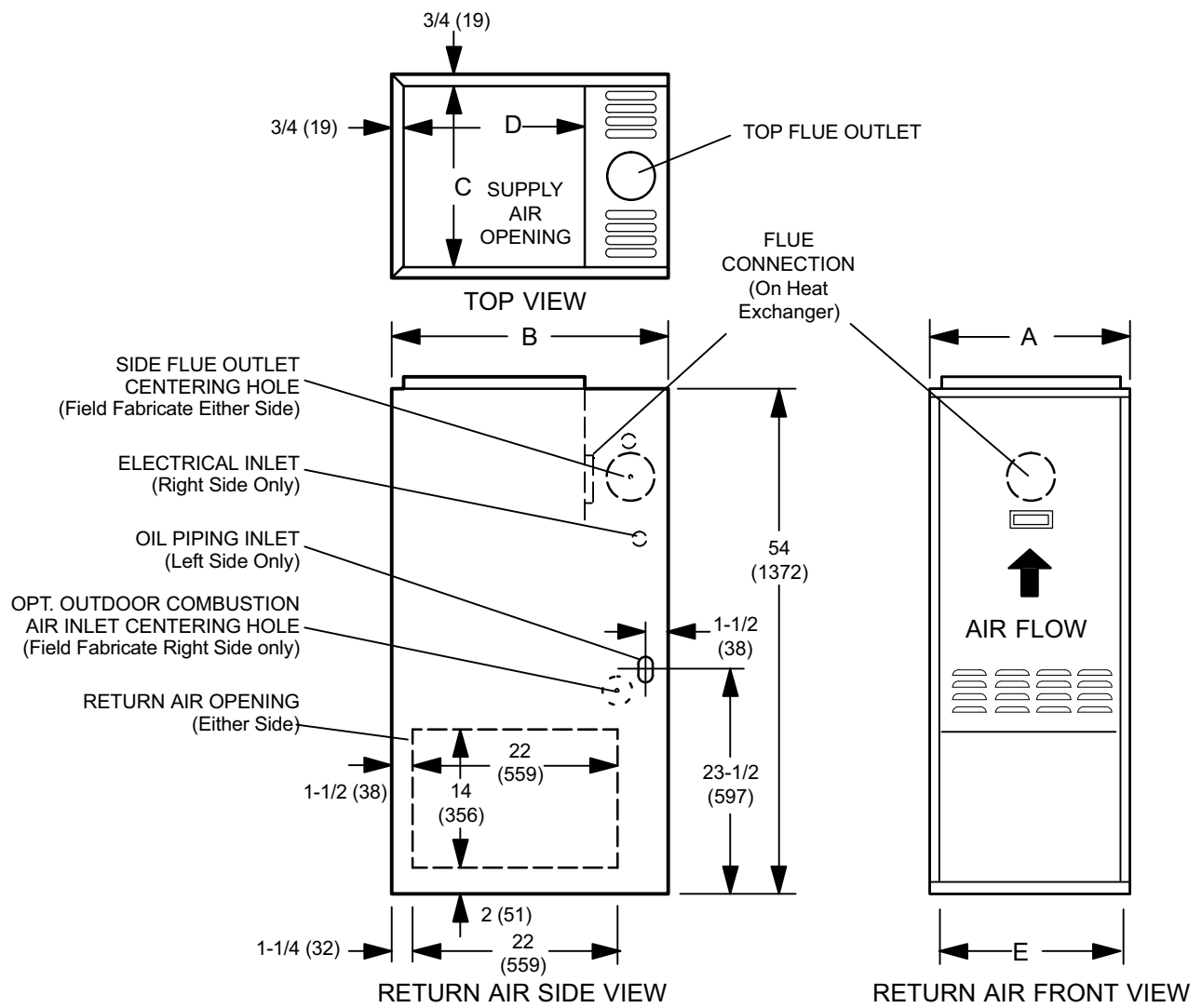

**Figure 1**

<b>SLO185UFV Unit Dimensions - Inches (mm)</b>					
<b>SLO185UFV Model</b>	<b>A</b>	<b>B</b>	<b>C</b>	<b>D</b>	<b>E</b>
79/105	19-1/2 (495)	30-5/8 (778)	18 (457)	19-5/8 (498)	16 (406)
124/141	22-1/2 (572)	33-1/8 (841)	21 (533)	22-1/8 (562)	18 (457)

## SLO185UFV Unit Parts Arrangement

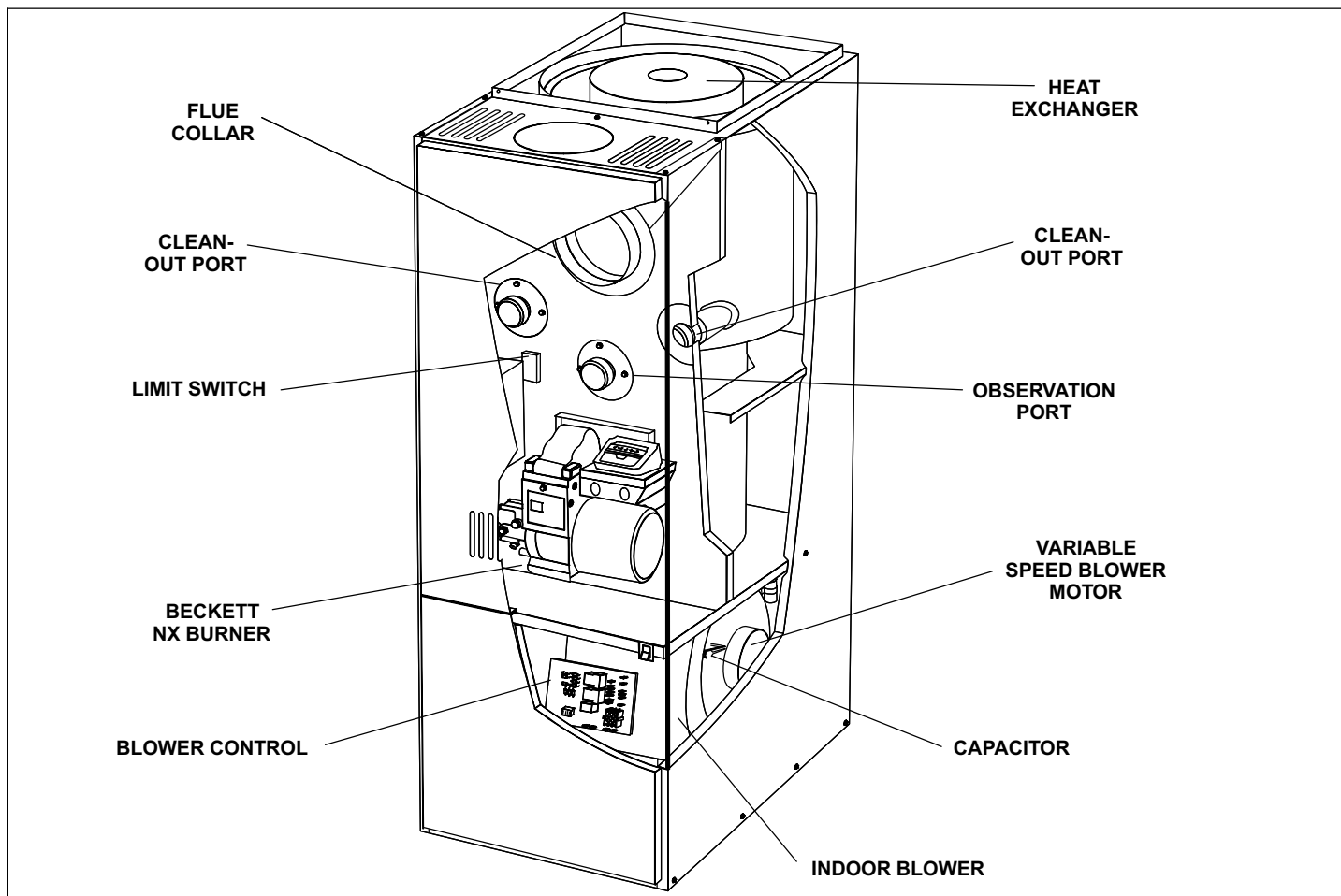

Figure 2

## SLO185UFV NX Burner Parts Arrangement

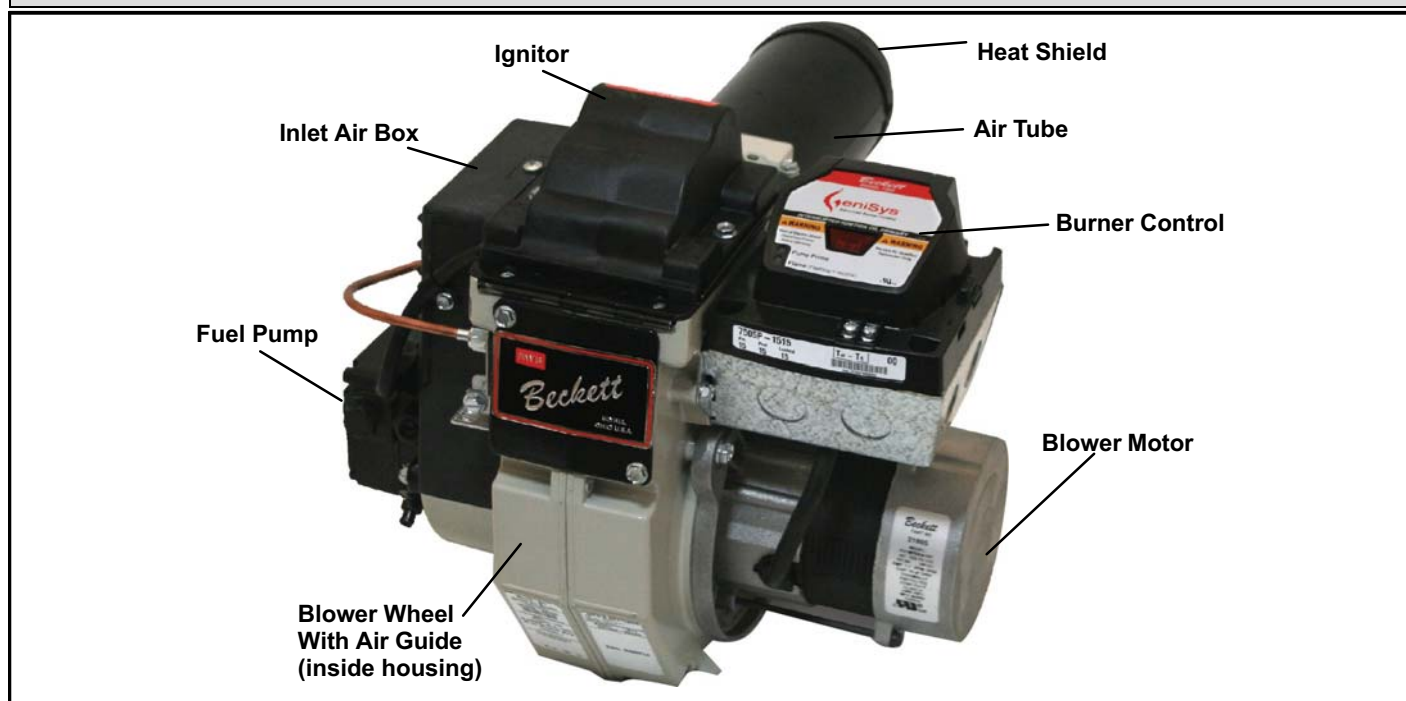

Figure 3

## Requirements

### **WARNING**

**This product contains a chemical known to the State of California to cause cancer, birth defects, or other reproductive harm.**

Installation of Lennox oil-fired furnaces must conform with the National Fire Protection Association Standard for the Installation of Oil Burning Equipment, NFPA No. 31, the National Electrical Code, ANSI/NFPA No.70 (in the U.S.A.), CSA Standard CAN/CSA-B139 (in Canada), Installation Code for Oil Burning Equipment, the Canadian Electrical Code Part1, CSA 22.1 (Canada), the recommendations of the National Environmental Systems Contractors Association and any state or provincial laws or local ordinances. Authorities having jurisdiction should be consulted before installation. Such applicable regulations or requirements take precedence over general instructions in this manual.

Chimneys and chimney connectors must be of the type and construction outlined in section 160 of NFPA No. 31. Air for combustion and ventilation must conform to standards outlined in section 140 of NFPA No. 31 or, in Canada, CSA Standard B139. When installing SLO185UFV units in confined spaces such as utility rooms, two combustion air openings are required. Dimensions of combustion air openings are shown in table 1. One opening shall be below burner level and the other opening shall be no more than 6" (152 mm) from the room's ceiling.

The combustion air opening should provide a minimum free area one-half square inch per 1,000 Btu per hour input. This combustion air should be brought into the area containing the furnace below the level of the furnace burner.

### **IMPORTANT**

**An opening to the outside for combustion air is strongly recommended, especially in new homes. Refer to table 1 or the unit rating plate for specific combustion air opening dimensions.**

Table 1

Combustion Air Opening Dimensions	
Model No.	(2 openings required)
SLO185UFV-79/105	10" X 20" (254 mm X 508 mm)
SLO185UFV-124/141	11" X 22" (279 mm X 559 mm)

This unit is approved for use on combustibile flooring and for clearances to combustibile material as listed on unit rating plate and in table 2. Unit service and accessibility clearances take precedence over fire protection clearances.

Table 2

SLO185UFV Installation Clearances	
Clearances	inches (mm)
top of plenum & duct	2 (51)
plenum sides	3 (76)
sides	0 (0)
rear	0 (0)
front	4 (120)
flue pipe	6 (152)

*NOTE - When service clearances are greater than fire protection clearances, service clearances take precedence.*

Obtain a temperature rise within the range listed in table 8 in the Start-Up section of this manual.

When installed, furnace must be electrically grounded in accordance with local codes or, in the absence of local codes, with the current National Electric Code, ANSI/NFPA No. 70, or Canadian Electric Code (CEC) if an external electrical source is utilized.

Field wiring connection with unit must meet or exceed specifications of type T wire and withstand a 63°F (17°C) temperature rise.

If installing a programmable thermostat, use a type which retains its memory in event of a power loss. When the furnace is used in conjunction with cooling units, it shall be installed in parallel with, or on the upstream side of, cooling units to avoid condensation in the heating element. With a parallel flow arrangement, a damper (or other means to control the flow of air) shall be adequate to prevent chilled air from entering the furnace and, if manually operated, must be equipped with means to prevent operation of either unit, unless damper is in the full "heat" or "cool" position.

### **WARNING**

**When an air conditioning unit is used in conjunction with the furnace, the evaporator coil must be installed in the discharge (supply) air. Do not install an evaporator coil in the return air; excessive condensation will occur within the furnace.**

## Notice to Home Owner

This furnace is equipped with safety devices that protect you and your property. If one or more of these devices is activated, furnace operation will stop. If your home is left unattended for an extended period of time, equipment operation must be checked periodically. If this is not possible, the water supply to the house should be shut off and the pipes should be drained. This will prevent problems associated with a NO HEAT condition (frozen pipes, etc.)

## Combustion and Ventilation Air

Homes built with energy conservation in mind use tight construction practices. These houses are sealed so well that it becomes necessary to provide a means of bringing in air from outside for combustion. Also, exhaust fans, appliance vents, chimneys and fireplaces force additional air that could be used for combustion out of the house. Unless outside air is brought into the home for combustion, negative pressure (pressure outside is greater than inside pressure) will build to the point that a down draft can occur in the furnace vent pipe or chimney. Combustion gases enter the living space creating a potentially dangerous situation. Negative pressure may also interfere with proper combustion, causing sooting within the heat exchanger.

The importance of the previous paragraph cannot be overstated. Users may inadvertently block fresh air intakes after installation.

In the absence of local codes concerning air for combustion and ventilation, the following section outlines guidelines and recommends procedures for operating oil furnaces in a manner that ensures efficient and safe operation. Special consideration must be given to combustion air needs as well as requirements for exhaust vents and oil piping.

### **Combustion Air Requirements**

## **⚠ CAUTION**

**Insufficient combustion air can cause headaches, nausea, dizziness or asphyxiation. It will also cause excess water in the heat exchanger resulting in rusting and premature heat exchanger failure. It can also cause property damage.**

All oil-fired appliances require air to be used for the combustion process. If sufficient amounts of combustion air are not available, the furnace or other appliance will operate in an inefficient and unsafe manner. Enough air must be provided to meet the needs of all fuel-burning appliances, as well as appliances such as exhaust fans which force air out of the home. When fireplaces, exhaust fans,

or clothes dryers are used at the same time as the furnace, much more air is required to ensure proper combustion and to prevent a down-draft situation. Insufficient amounts of air also cause incomplete combustion which can result in sooting. Requirements for providing air for combustion and ventilation depend largely on whether the furnace is installed in an unconfined or confined space.

### **Unconfined Space**

An unconfined space is an area such as a basement or large equipment room with a volume greater than 50 cubic feet (1.4 cubic meters) per 1,000 Btu (293 W) per hour of the combined input rating of all appliances installed in that space. This space also includes adjacent rooms which are not separated by a door. Though an area may appear to be unconfined, it might be necessary to bring in outdoor air for combustion if the structure does not provide enough air by infiltration. If the furnace is located in a building of tight construction with weather stripping and caulking around the windows and doors, follow the procedures outlined for using air from the outside for combustion and ventilation.

### **Confined Space**

A confined space is an area with volume less than 50 cubic feet (1.4 cubic meters) per 1,000 Btu (293 W) per hour of the combined input rating of all appliances installed in that space. This definition includes furnace closets or small equipment rooms.

When the furnace is installed so that supply ducts carry air circulated by the furnace to areas outside the space containing the furnace, the return air must be handled by ducts which are sealed to the furnace casing and which terminate outside the space containing the furnace. This is especially important when the furnace is mounted on a platform in a confined space such as a closet or small equipment room. Even a small leak around the base of the unit at the platform or at the return air duct connection can cause a potentially dangerous negative pressure condition. Air for combustion and ventilation can be brought into the confined space either from inside the building or from outside.

### **Air from an Adjacent Space**

If the confined space housing the furnace adjoins space categorized as unconfined, air can be brought in by providing two permanent openings between the two spaces. Each opening must have a minimum free area of 1 square inch (6.4 square centimeters) per 1,000 Btu (293 W) per hour of the total input rating of all fuel-fired equipment in the confined space. Each opening must be at least 100 square inches (614.5 square centimeters). One opening shall be within 12" (305 mm) of the top of the enclosure and one opening within 12" (305 mm) of the bottom (See figure 4).

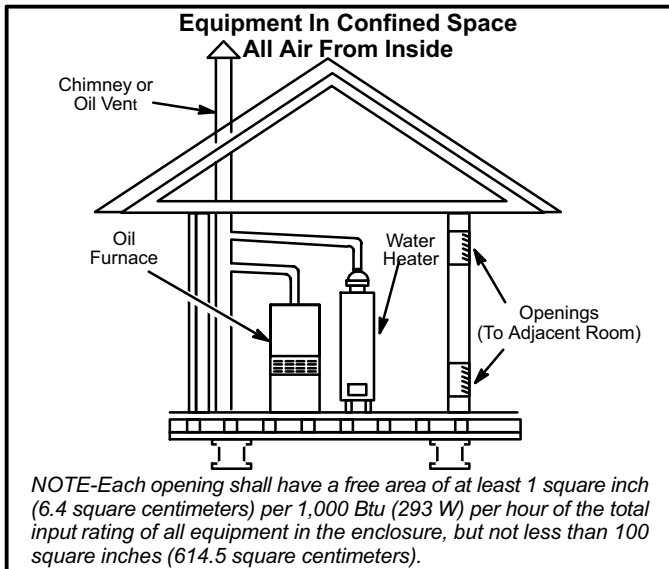

**Figure 4**

**Air from Outside**

If air from outside is brought in for combustion and ventilation, the confined space shall be provided with two permanent openings. One opening shall be within 12" (305 mm) of the top of the enclosure and one within 12" (305 mm) of the bottom. These openings must communicate directly or by ducts with the outdoors or spaces (crawl or attic) that freely communicate with the outdoors or indirectly through vertical ducts. Each opening shall have a minimum free area of 1 square inch (6.4 square centimeters) per 4,000 Btu (1172 W) per hour of total input rating of all equipment in the enclosure. (See figure 5.) When communicating with the outdoors through horizontal ducts, each opening shall have a minimum free area of 1 square inch (6.4 square centimeters) per 2,000 Btu (586 W) per total input rating of all equipment in the enclosure (See figure 6).

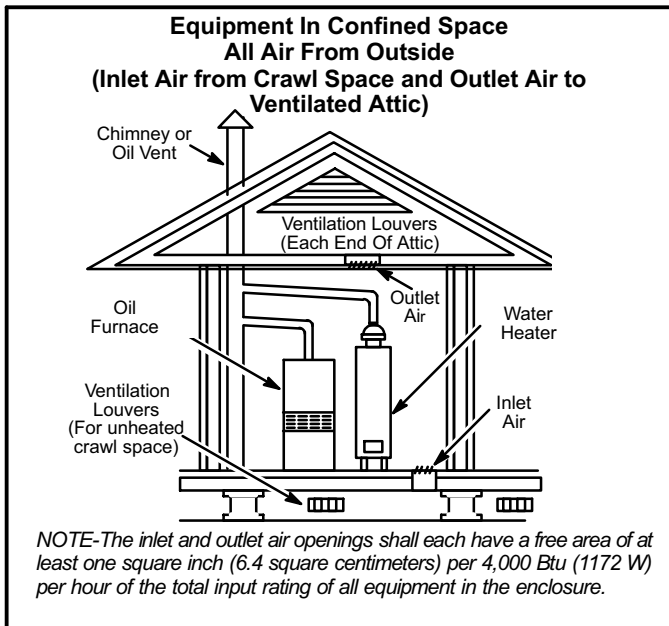

**Figure 5**

When ducts are used, they shall be of the same cross-sectional area as the free area of the openings to which they connect. The minimum dimension of rectangular air ducts shall be no less than 3" (76 mm). In calculating free area, the blocking effect of louvers, grilles, or screens must be considered. If the design and free area of protective covering is not known for calculating the size opening required, it may be assumed that wood louvers will have 20 to 25 percent free area and metal louvers and grilles will have 60 to 75 percent free area. Louvers and grilles must be fixed in the open position or interlocked with the equipment so that they are opened automatically during equipment operation.

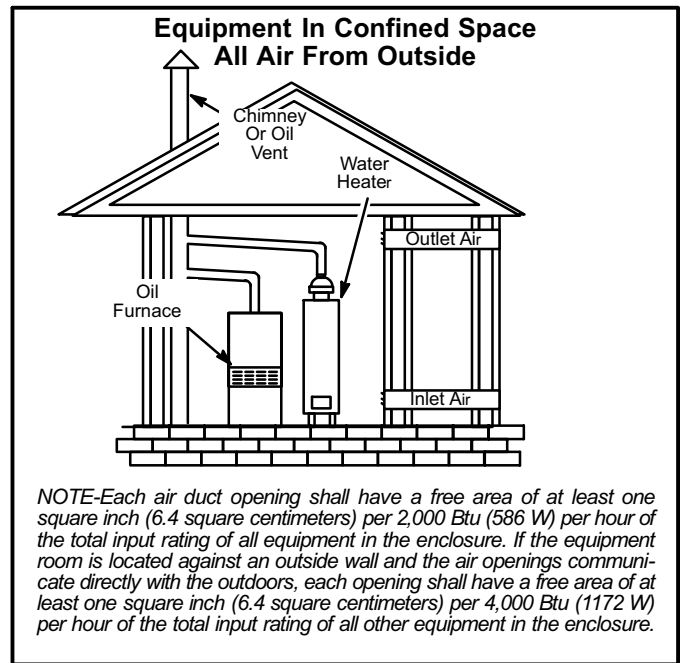

**Figure 6**

**⚠ CAUTION**

**Combustion air openings in the front of the furnace must be kept free of obstructions. Any obstruction will cause improper burner operation and may result in a fire hazard or injury.**

**⚠ WARNING**

**The barometric draft control must be removed from the vent pipe when using a combustion air adapter. Deviation from this practice will cause improper burner operation and may allow flue products into the living space which may result in personal injury or death.**

**Locate & Level the Unit**

Set the unit in desired location keeping in mind the clearances listed in table 2. Also keep in mind oil supply connections, electrical supply, flue connections and sufficient clearance for installing and servicing unit.

Level the unit from side to side and from front to rear. If the furnace is not level, place fireproof wedges or shims between the low side of the furnace and the floor. Make sure the weight of the furnace is distributed evenly on all four corners. Strain on sides of cabinet causing cracking and popping noises may occur if weight of furnace is not evenly distributed.

**Adjustments**

Neither the nozzle setting nor the air adjustments are factory set. The furnace is fire-tested and the limit control is checked to make sure it functions properly; no factory settings are made. During installation, the furnace must be "set up." The installing dealer/contractor must have and use proper test equipment in order to correctly set up the oil furnace. Proper testing equipment is required to ensure correct operation of the unit. The use of test equipment is now more critical than ever due to tighter tolerances needed to keep the furnace operating efficiently.

Among the test equipment for an oil furnace, the proper combustion test kit should contain the following:

- Draft gauge
- CO<sub>2</sub> or O<sub>2</sub> analyzer
- Smoke tester
- Pressure gauge
- High temperature thermometer
- Beckett T-501 nozzle gauge
- Oil vacuum gauge
- Knowledge of proper test equipment operation

**CAUTION**  
 Improper nozzle and/or air adjustment of this unit may result in sooting problems. Refer to the following section for correct adjustment procedures.

**Adjusting the Nozzle**

Proper adjustment of the nozzle assembly is critical. Before the flue pipe and oil lines are installed, the nozzle assembly must be checked for proper depth and alignment. You must remove the entire burner assembly (not just the nozzle) from the furnace to check the nozzle depth and alignment. The smaller sized firing nozzle has been factory-installed. This should be verified by the installer. A larger nozzle has been provided in the bag assembly for use with SLO185UFV 105 and 141 units. Inspect the spark transformer leads also to ensure they are still attached to the electrodes.

The burner assembly is attached to the vestibule panel by three nuts. Slots are provided in the mounting flange for removing the burner assembly from the vestibule. Loosen the nuts and turn the whole burner assembly clockwise

(figure 7) to remove the entire burner assembly from the furnace. There is adequate wire to remove the burner without disconnecting wires. Once removed, turn the burner around in the vest panel area.

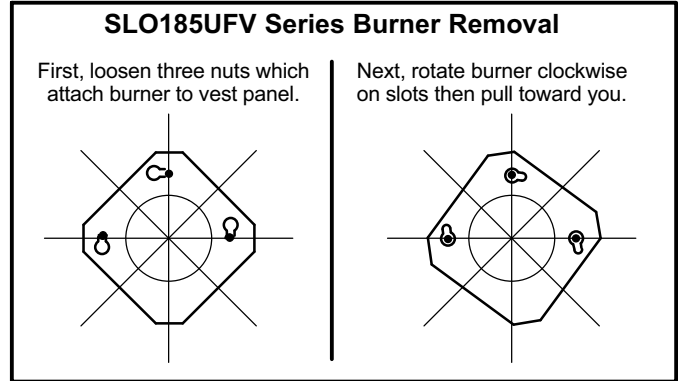
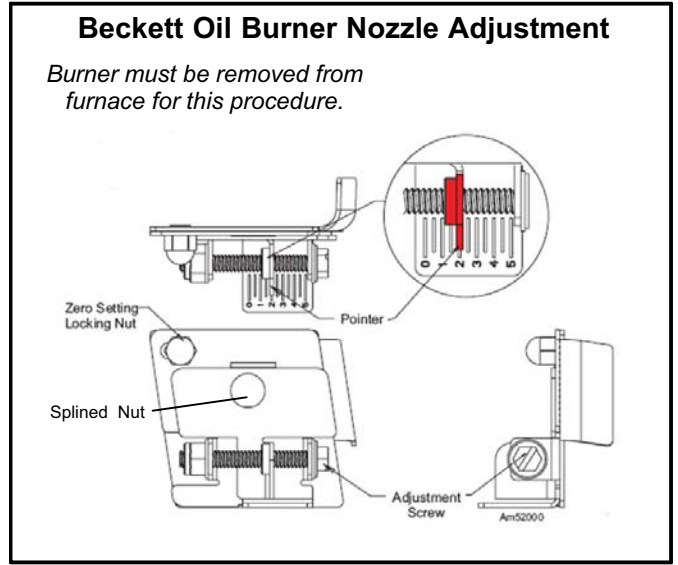

**Figure 7**

To check the ignition electrode gap use the T-501 gauge. The proper gap should be 5/32".

To check nozzle alignment, again insert the small end of gauge into the end cone and measure the nozzle and electrode alignment against the center lines marked on the gauge (again refer to enclosed illustration sheet). If the nozzle is not centered, but found to be too far left or right, a new nozzle assembly will need to be ordered. Do not attempt to adjust by bending the 90 degree elbow in the oil line.

Take care to properly re-install burner assembly when nozzle adjustment has been completed.



**Figure 8**

## Indoor Coil Placement

When matching a Lennox branded A-coil to an upflow oil furnace, make sure coil width is appropriate for full air flow into and through the coil. If there is any doubt, it is recommended that coil is installed at least four inches above the furnace cabinet. If a non-Lennox coil is used, consult the coil's literature for the recommended distance from the top of the furnace cabinet. If the literature does not have a recommended distance, the coil should be mounted at least eight inches above top of furnace cabinet.

## Venting

### **⚠ WARNING**

Combustion air openings in front of the furnace must be kept free of obstructions. Any obstruction will cause improper burner operation and may result in a fire hazard.

### **⚠ WARNING**

The barometric draft control must be removed from the vent pipe when using an air intake kit. Deviation from this practice will cause improper burner operation and may allow flue products into the living space which may result in personal injury or death.

An air intake kit used to provide fresh air directly to the burner, is available through Lennox. Order part number 11F44.

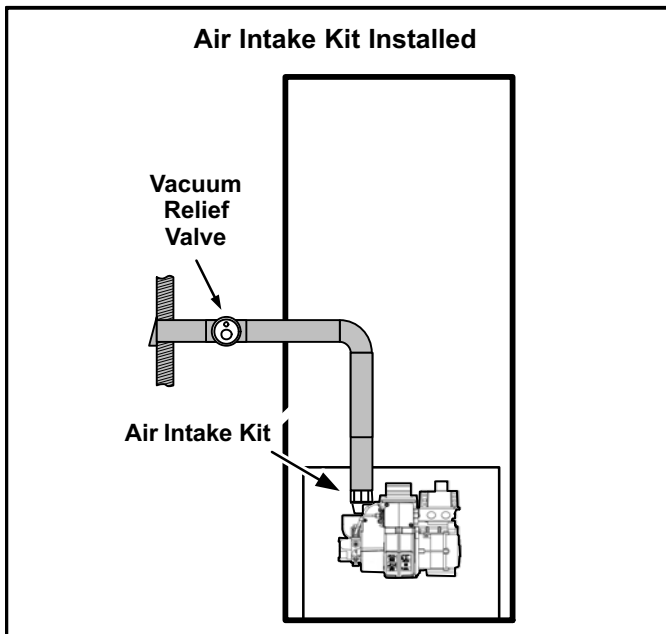

Figure 9

### **⚠ CAUTION**

Do not store combustible materials near the furnace or supply air ducts. The material (such as paint, motor oil, gasoline, paint thinner, etc.) may ignite by spontaneous combustion creating a fire hazard.

### **⚠ WARNING**

This furnace is certified for use with type "L" vent. "B" vent must not be used with oil furnaces.

Prior to installation of unit, make a thorough inspection of the chimney to determine whether repairs are necessary. Make sure the chimney is properly constructed and sized according to the requirements of the National Fire Protection Association. The smallest dimensions of the chimney should be at least equal to the diameter of the furnace vent connector. Make sure the chimney will produce a steady draft sufficient to remove all the products of combustion from the furnace. A draft of at least .04" w.c. (9.9 Pa) is required during burner operation.

- 1 - Local building codes may have more stringent installation requirements and should be consulted before installation of unit.
- 2 - The vent connector should be as short as possible to do the job.
- 3 - The vent connector should not be smaller than the outlet diameter of the vent outlet of the furnace.
- 4 - Pipe should be at least 24 gauge galvanized.
- 5 - Single wall vent pipe should not run outside or through any unconditioned space.
- 6 - Chimney should extend 3 feet (0.9 m) above highest point where the vent passes through the roof, and 2 feet (0.6 m) higher than any portion of a building within a horizontal distance of 10 feet (3 m).
- 7 - The vent must not pass through a floor or ceiling. Clearances to single wall vent pipe should be no less than 6" (152 mm); more if local codes require it.
- 8 - The vent may pass through a wall where provisions have been made for a thimble as specified in the Standards of the National Board of Fire Underwriters. See figure 10.

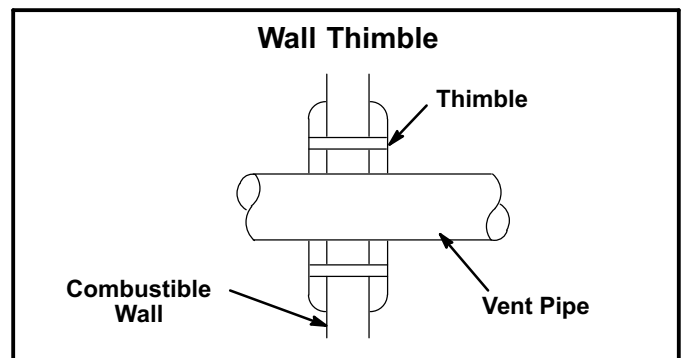

Figure 10

- 9 - The vent pipe should slope upward toward the chimney on horizontal run at least 1/4 inch (6 mm) to the foot (0.3 m) and should be supported by something other than the furnace, such as isolation hangers.



- 10 - Extend the vent pipe into the chimney so that it is flush with the inside of the chimney liner. Seal the joint between the pipe and the liner.
- 11 - The furnace shall be connected to either a factory-built chimney or vent which complies with a recognized standard, or to a masonry or concrete chimney which has been lined with a material acceptable to the authority having jurisdiction.
- 12 - When two or more appliances vent into a common vent, the area of the common vent should not be less than the area of the largest vent or vent connection plus 50% of the area of the additional vent or vent connection. Chimney must be able to sufficiently vent all appliances operating at the same time.

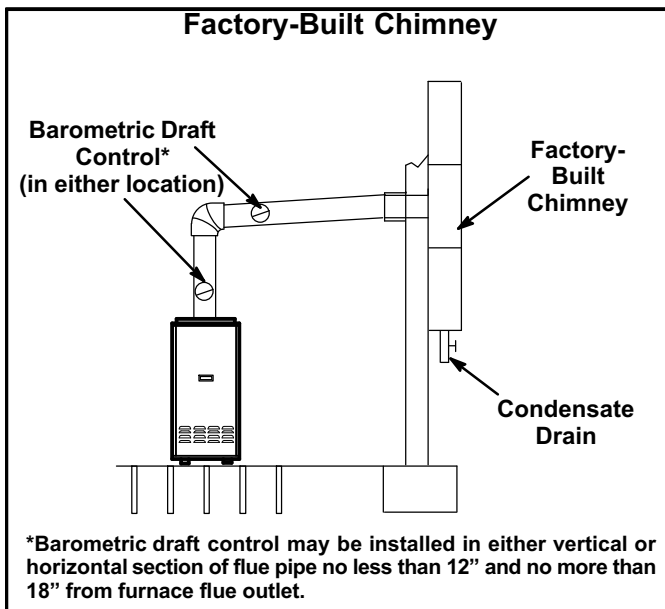

Figure 11

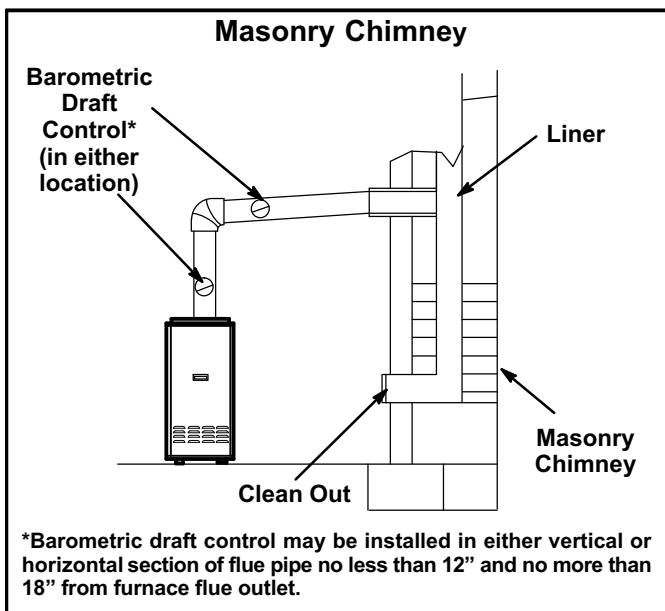

Figure 12

- 13 - The vent pipe shall not be connected to a chimney vent serving a solid fuel appliance or any mechanical draft system.
- 14 - All unused chimney openings should be closed.
- 15 - All vent pipe run through unconditioned areas or outside shall be constructed of factory-built chimney sections. See figure 11.
- 16 - Where condensation of vent gas is apparent, the vent should be repaired or replaced. Accumulation of condensation in the vent is unacceptable.
- 17 - Vent connectors serving this appliance shall not be connected into any portion of mechanical draft systems operating under positive pressure.
- 18 - Keep the area around the vent terminal free of snow, ice and debris.

*NOTE - If vent pipe needs to exit from side of cabinet, use the pilot hole (located on either side of the unit) to cut a 6" (152 mm) round hole. Attach finishing plate (provided) with four sheet metal screws to cover rough edges.*

#### Removal of Unit from Common Venting System

In the event that an existing furnace is removed from a venting system commonly run with separate appliances, the venting system is likely to be too large to properly vent the remaining attached appliances. The following test should be conducted while each appliance is in operation and the other appliances not in operation remain connected to the common venting system. If venting system has been installed improperly, the system must be corrected as outlined in the previous section.

- 1 - Seal any unused openings in the common venting system.
- 2 - Visually inspect venting system for proper size and horizontal pitch and determine there is no blockage or restriction, leakage, corrosion or other deficiencies which could cause an unsafe condition.
- 3 - Insofar as is practical, close all building doors and windows and all doors between the space in which the appliances remaining connected to the common venting system are located and other spaces of the building. Turn on clothes dryers and any appliances not connected to the common venting system. Turn on any exhaust fans, such as range hoods and bathroom exhausts, so they will operate at maximum speed. Do not operate a summer exhaust fan. Close fireplace dampers.
- 4 - Following the lighting instruction on the unit, place the appliance being inspected in operation. Adjust thermostat so appliance will operate continuously.
- 5 - Test for spillage using a draft gauge.

- 6 - After it has been determined that each appliance remaining connected to the common venting system properly vents when tested as outlined above, return doors, windows, exhaust fans, fireplace dampers and any other fuel burning appliance to its previous condition of use.
- 7 - If improper venting is observed during any of the above tests, the common venting system must be corrected.

## Flue Connections

### ⚠ IMPORTANT

**When flue pipe is installed at less than minimum clearance listed in table 2, radiation shields must be installed. See figure 13.**

Use 24 gauge or heavier galvanized smoke pipe and fittings to connect the furnace to the vent. Connect flue pipe to chimney using the least number of elbows and angles possible. Flue pipe or vent connector must be inserted into but not beyond the inside surface of the chimney flue. No reduction in diameter of flue pipe is acceptable. It is best to have flue pipe as short and direct as possible. Where two or more appliances vent into a common flue, the area of the common flue should be at least equal to the area of the largest flue or vent connector, plus 50% of the area of any additional flues or vent connectors. Install a barometric draft control (provided) and flue pipe according to instructions packed with control.

Inspect flue pipe annually. Clean soot or ash from flue pipe, if necessary. If pipe is rusted, replace.

### Barometric Draft Control Installation

**NOTE - DO NOT install the barometric draft control if the furnace is equipped with an air intake kit. See figure 9.**

Install the provided barometric draft control in the flue pipe **at least 12 inches** beyond the furnace flue outlet to provide space for flue gas sampling. The barometric draft control may be installed in either vertical or horizontal sections of the flue pipe; however, it should be positioned **no more than 18"** beyond the furnace flue outlet. Follow the instructions packed with the barometric draft control.

### Alternate Side Flue Connections

The vent pipe may exit the top or sides of the cabinet. A hole is provided in the top cap for top exit. For side exit, locate the center hole punched in the side of the cabinet. See unit dimensions on page 2. Using it as the center point, cut a 6 inch (152 mm) round hole in the cabinet's side. **Install the barometric draft control within 18 inches of the furnace flue outlet.** Attach the provided finishing plate to cover rough edges.

## Supply & Return Air Plenums

Secure return air plenum to unit using sheet metal screws.

**NOTE - The following are suggested procedures that should be followed when installing the supply air plenum.**

1. Use sealing strips of fiberglass.
2. In all cases, the plenum should be secured to furnace or evaporator cabinet with sheet metal screws.
3. Install supply and return air ducts as desired.

## Oil Supply Line Sizing

Ensure that the restrictions of the piping system, plus any lift involved, do not exceed the capability of the oil pump. Use the following guidelines when determining whether to use a single- or two-stage oil pump.

### One-Pipe System

When using a one-pipe system (see figure 14), even with the oil tank that is above the burner and a vacuum of 6" (152 mm) Hg or less, a single-stage fuel pump with a supply line and no return line should be adequate.

Manual bleeding of the fuel pump is required on initial start up. Failure to bleed air from the oil pump could result in an air lock/oil starvation condition.

**NOTE - As an extra precaution, cycle heating on and off ten times after bleeding air from the oil pump. This will eliminate air in the gun assembly.**

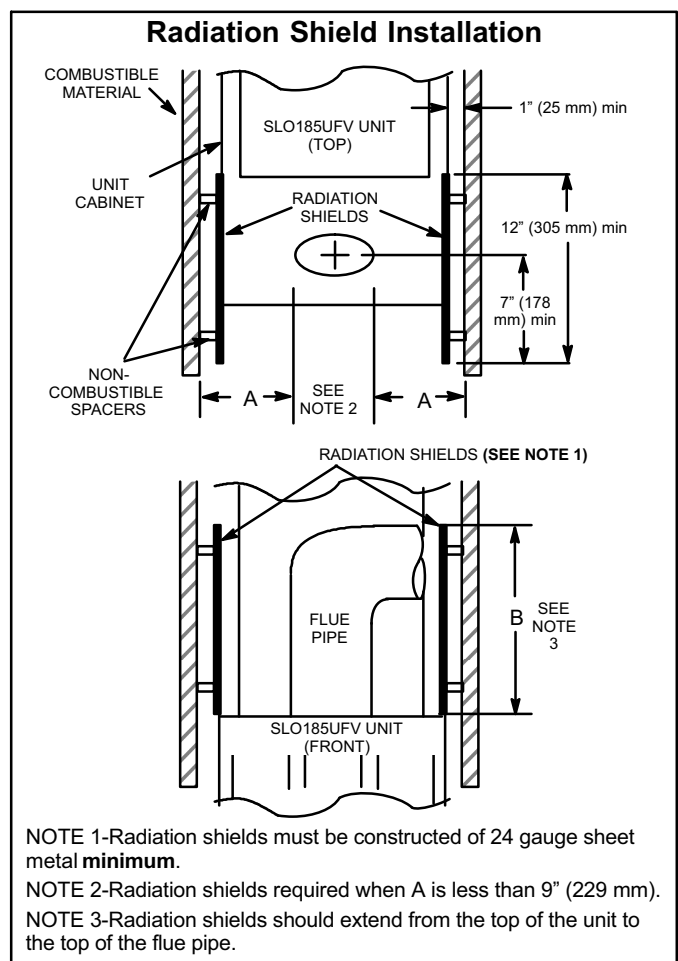

**Figure 13**

**Table 3  
Fuel Pump Usage**

Pump	Piping Application	Maximum Lift (vacuum)
Single-Stage Pump	One-Pipe System	8 ft. (6" Hg vacuum)
	Two-Pipe System	10 ft. (12" Hg vacuum)
Two-Stage Pump	Two-Pipe System	10 ft. or greater (12" to 17" Hg vacuum)

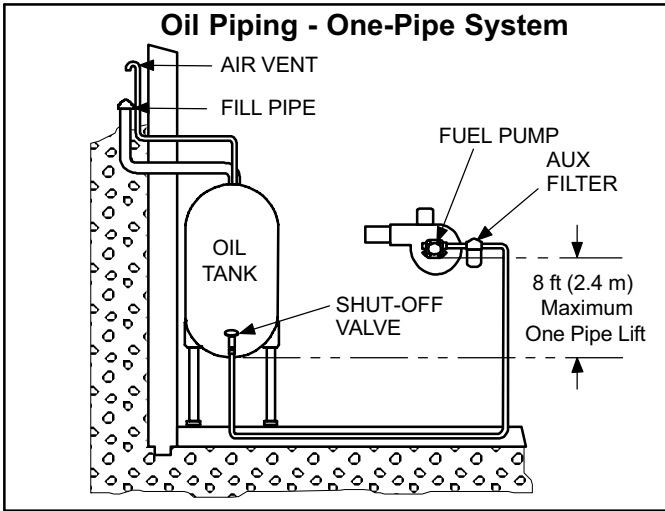

**Figure 14**

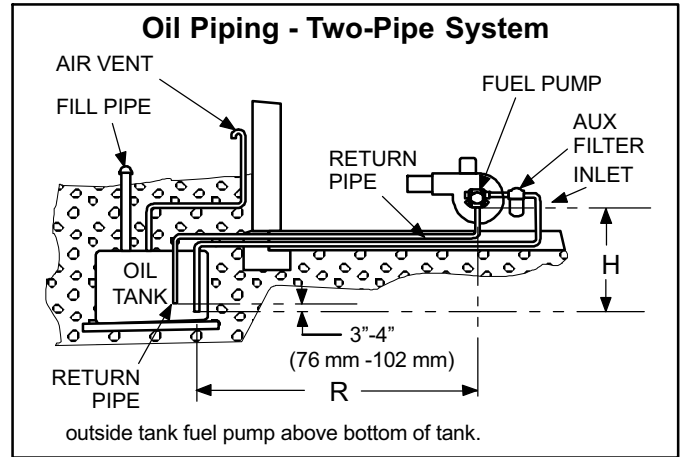

**Figure 15**

To determine the correct tubing size for piping, refer to table 4

**Table 4**

One-Pipe Oil Line Sizing	
Line Length	Pipe Diameter (OD Tubing)
0-50' (15 m)	3/8" (10 mm)
51-100' (15 m)	1/2" (12 mm)

**Two-Pipe System**

When using a two-pipe system (see figure 15) with the oil tank below the level of the burner, use a single-stage fuel pump in lift conditions of up to 10 feet (3 m) and/or a vacuum of 10" (254 mm) Hg or less. Use a two-stage fuel pump when lift exceeds 10 feet (3 m) and/or a vacuum of 10" (254 mm) Hg to 15" (381 mm) Hg. Both conditions require the use of a two-pipe system, which consists of a return line that purges the fuel pump of air by returning it to the tank. To determine the run and lift for piping, refer to table 5 .

Use continuous lengths of heavy wall copper tubing or steel pipe for oil supply pipe. Install oil supply pipe under floor or near walls to protect it from damage. Avoid running pipes along joists or reverberating surfaces. Always use flare fittings. All fittings must be accessible. Do not use compression fittings.

**⚠ IMPORTANT**

**Both oil supply and return pipes must be submerged in oil in the supply tank.**

**Table 5**

Lift "H" ft (m)	Two-Pipe Maximum Pipe Length (H + R) 3450 RPM - 3 GPH (11.4 LPH)			
	Single-Stage	Two-Stage	Single-Stage	Two-Stage
	3/8" (10 mm) OD Tubing - ft (m)		1/2" (12 mm) OD Tubing	
0' (0.0)	84 (25.6)	93 (28.3)	100 (30.5)	100 (30.5)
2' (0.6)	73 (22.3)	85 (25.9)	100 (30.5)	100 (30.5)
4' (1.2)	63 (19.2)	77 (23.5)	100 (30.5)	100 (30.5)
6' (1.8)	52 (15.8)	69 (21.0)	100 (30.5)	100 (30.5)
8' (2.4)	42 (12.8)	60 (18.3)	100 (30.5)	100 (30.5)
10' (3.0)	31 (9.4)	52 (15.9)	100 (30.5)	100 (30.5)
12' (3.7)	21 (6.4)	44 (13.4)	83 (25.3)	100 (30.5)
14' (4.3)	---	36 (11.0)	41 (12.5)	100 (30.5)
16' (4.9)	---	27 (8.2)	---	100 (30.5)
18' (5.5)	---	---	---	76 (23.2)

## Oil Supply Line & Filter Connections

### One-Pipe Systems

#### CAUTION

**Do not install the bypass plug into the pump on one-pipe systems.**

The burner is shipped with a single-stage fuel pump set for one-pipe operation. For one-pipe systems, the oil supply pipe is connected to the inlet tap on the pump. A one-pipe system should only be used where there is gravity oil flow to the pump or there is no more than 8 ft. of vertical lift (or 6 in. Hg) from the oil tank to the fuel pump.

- 1 - Connect the inlet pipe to the pump inlet. Start the burner.
- 2 - Turn the bleed valve one turn counterclockwise.
- 3 - Bleed the unit until all air bubbles disappear.

*NOTE - Hurried bleeding will prevent the unit from operating properly.*

- 4 - If necessary, put GeniSys™ primary control into its 4-minute pump priming mode. Refer to table 10.
- 5 - Tighten the bleed valve securely.

### Two-Pipe Systems

If the installation requires a two-pipe operation, install the bypass plug included in the bag which is attached to the pump. To convert the pump, install the bypass plug according to the provided pump instructions. Notice in the two-pipe system the return pipe must terminate in the tank 3" (76 mm) to 4" (102 mm) above the supply inlet. Ensure the return pipe terminates at the correct measurement or air may escape into the system. This could result in loss of prime.

*NOTE- If using an outside tank in cold climates a number one fuel or an oil treatment is strongly recommended.*

1. Remove 1/4" plug from return port.
2. Insert bypass plug and tighten it (see figure 15).
3. Attach the return and inlet pipes. Start the burner. Air bleeding is automatic.

*NOTE - If a faster bleed is necessary, open the bleed valve.*

4. The return pipe must terminate 3" to 4" above the supply pipe inlet (see figure 15).

*NOTE - If the return pipe does not terminate where it should, air may enter the system, and prime may be lost.*

**An oil filter is required for all models.** Install filter inside the building between the tank shut-off valve and the burner. Locate filter close to burner for easy maintenance. Table 6 lists the filters for the SLO185UFV furnace.

Table 6

Oil Filters	Cat. No.
10 micron filter (no mounting bracket)	81P89
10 micron filter (mounting bracket)	53P92
10 micron replacement cartridge for filter, 45 gph	53P93
Filter restriction indicator gauge	53P90

Consult burner manufacturer's instructions packaged with unit for further details concerning oil supply pipe connections.

### Leak Check

After oil piping is completed, carefully check all piping connections (factory and field) for oil leaks.

### Oil Pipe Heater (Optional)

A heater for the oil pipe is available for applications that are located in cold climates. The heater warms the oil pipe to assist the initial start-up.

### Electrical

All wiring must conform to the National Electric Code (NEC), or Canadian Electric Code (CEC) and any local codes. Refer to figure 16 for typical unit wiring diagram. See figures and for field wiring. Refer to figure 20 for terminal designations on blower control.

- 1 - Refer to appliance rating plate for proper fuse size.
- 2 - Install room thermostat and make wire connections to the fan control board. Avoid installing thermostat on an outside wall or where it can be affected by radiant heat. Set the adjustable heat anticipator on thermostat according to the wiring diagram sticker provided on unit.
- 3 - Install a separate fused disconnect switch near unit so power can be shut off for servicing.
- 4 - Complete line voltage wiring from disconnect switch near unit to make-up box.

*NOTE - An equipment ground screw is provided. Refer to unit wiring diagram. Ground unit using a suitable ground wire.*

- 5 - A 24V dehumidistat can be connected to the reverse-acting HUM terminal on the A54 blower control. See figure 20.

#### WARNING



**Electric Shock Hazard. Can cause injury or death. Unit must be properly grounded in accordance with national and local codes.**

#### WARNING

**Run 24V Class II wiring only through specified low voltage opening. Run line voltage wiring only through specified high voltage opening. Do not combine voltage in one opening.**

# ⚠ IMPORTANT

If using a programmable thermostat, be sure to use a type of thermostat that retains its memory in event of a power loss.

# ⚠ WARNING

Fire Hazard. Use of aluminum wire with this product may result in a fire, causing property damage, severe injury or death. Use copper wire only with this product.

# ⚠ CAUTION

Failure to use properly sized wiring and circuit breaker may result in property damage. Size wiring and circuit breaker(s) per Product Specifications bulletin (EHB) and unit rating plate.

## Typical SLO185UFV Wiring Diagram

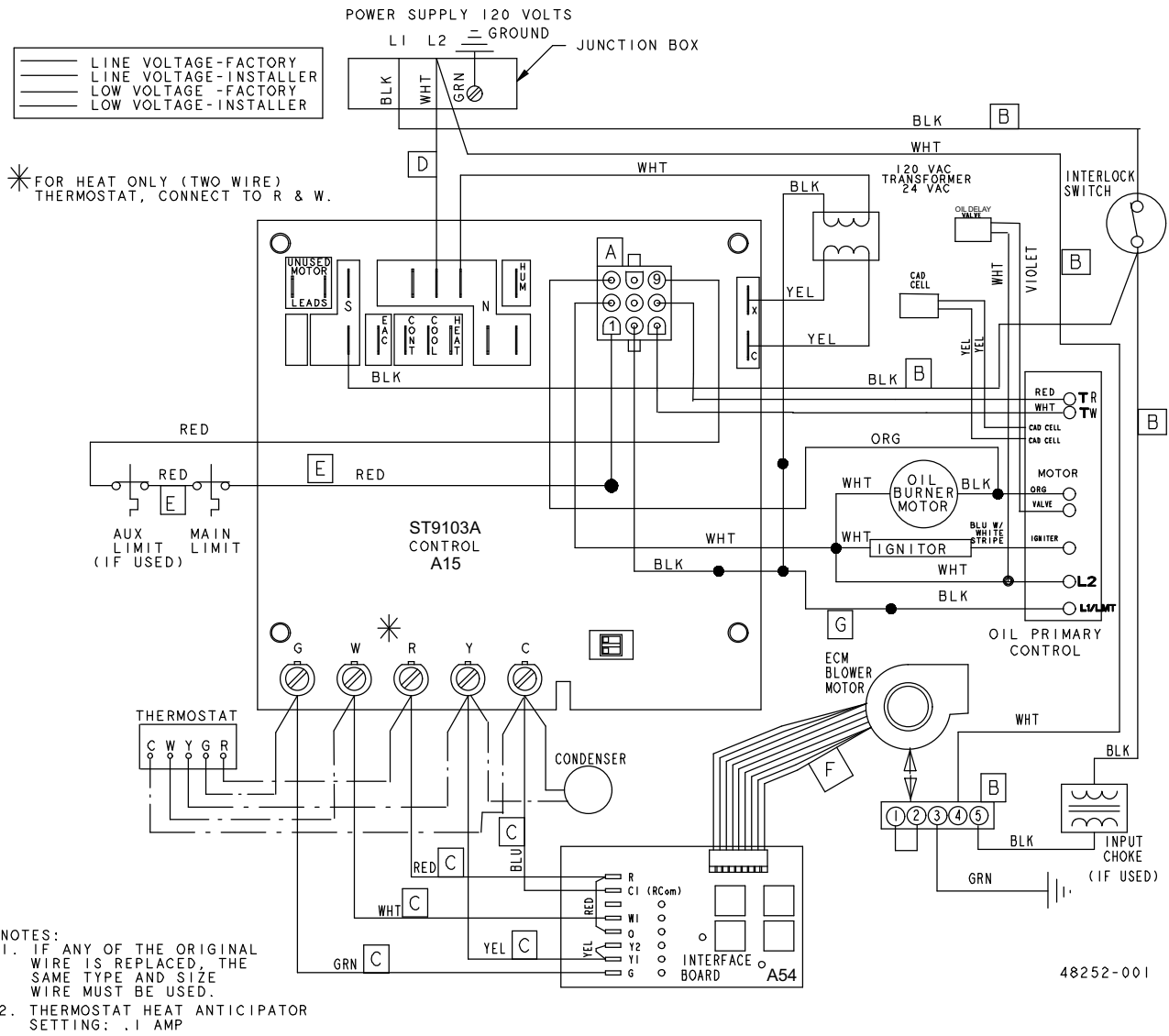
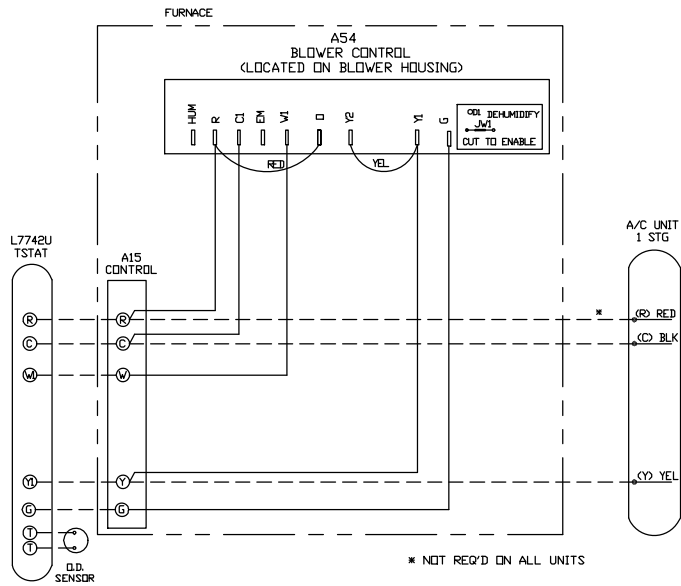

Figure 16

# Field Wiring Diagrams

## 1 Heat / 1 Cool



## 1 Heat / 2 Cool

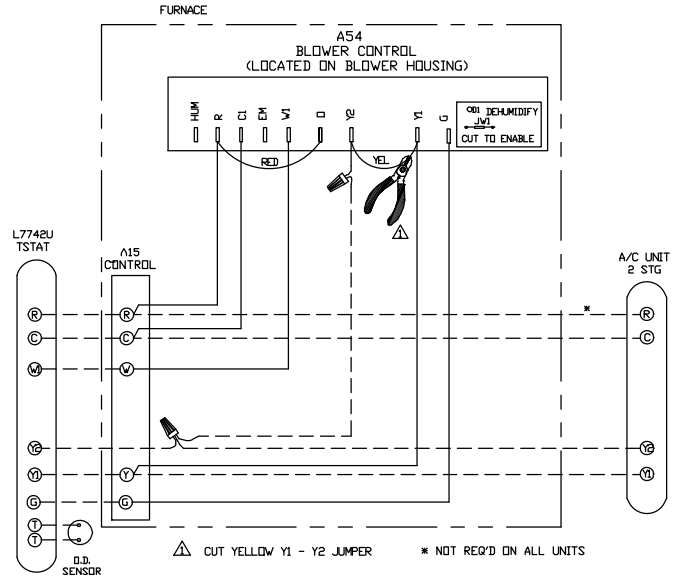

## 1 Heat / 1 Cool With Thermostat Dehumidification Mode

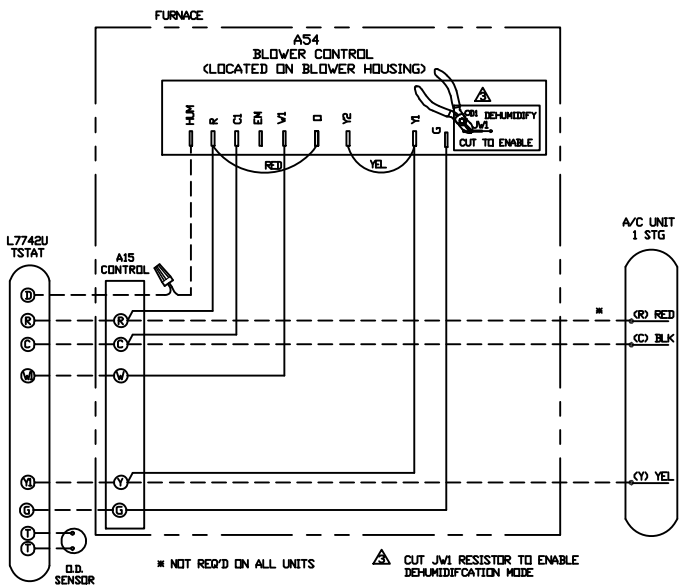

## 1 Heat / 2 Cool With Thermostat Dehumidification Mode

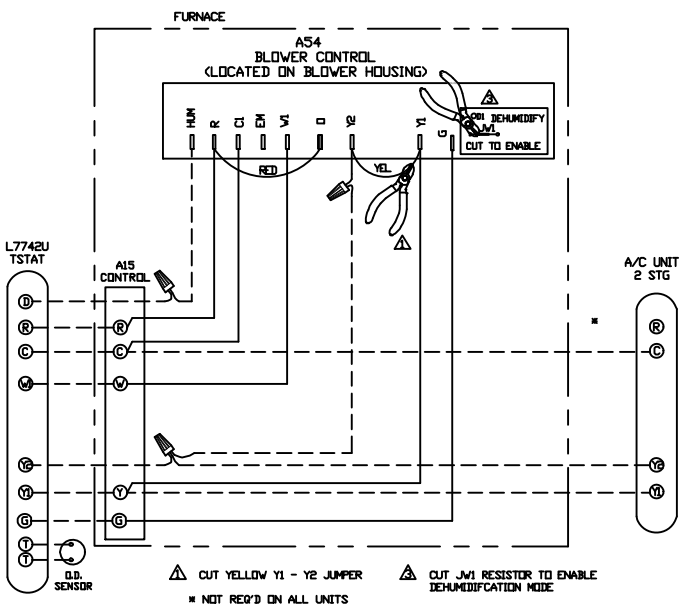
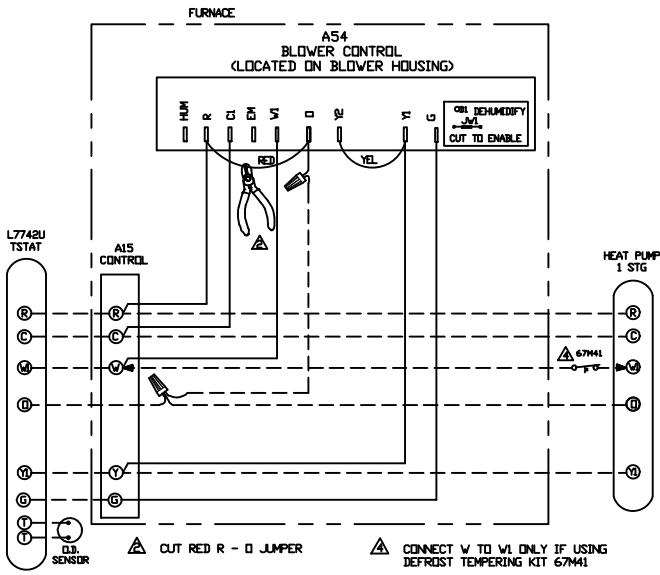

Figure 17

## Field Wiring Diagrams (Continued)

### Dual Fuel Single-Stage Heat Pump With Dual Fuel Control Mode



### Dual Fuel Two-Stage Heat Pump With Dual Fuel Control Mode

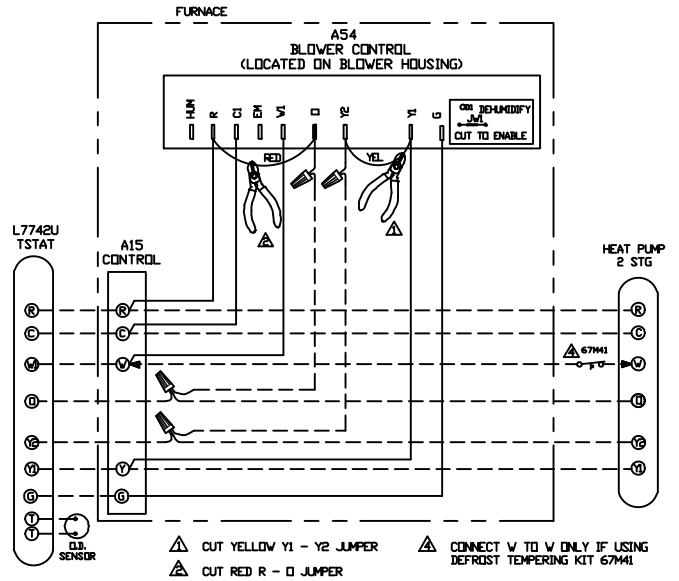

### Dual Fuel Two-Stage Heat Pump With Dual Fuel Control Mode and Thermostat Dehumidification Mode

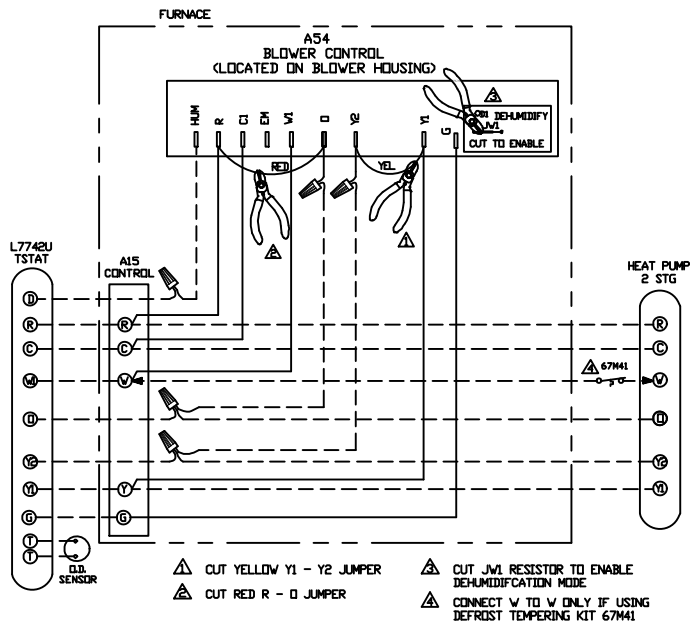

Figure 18

## Blower Control (A54)

### **⚠ WARNING**



**Electric shock hazard. Can cause injury or death. Before attempting to perform any service or maintenance, turn the electrical power to unit OFF at disconnect switch(es). Unit may have multiple power supplies.**

SLO185UFV units are equipped with a variable speed blower motor which is capable of maintaining a specified CFM throughout the external static range. Harmony zone controls cannot be used with this furnace since the ECM motor is not programmed for variable speed operation. The blower motor is controlled by jumper selections made on the A54 blower control. Jumpers are available to select both heating and cooling blower speeds, as well as adjustment rates for cooling blower speeds and a test mode. Blower control settings and operation are described in this section.

The units are factory-set for nominal airflow for each model. Figure 20 shows the blower control. Use table 7 to determine the correct air volume for operation in heat and cool mode.

Read this section thoroughly before adjusting the jumpers to obtain the appropriate blower speed.

To change jumper positions, gently pull the jumper off the pins and re-position it across the pins that will give the desired blower speed. The following section outlines the different jumper selections available and conditions associated with each one (see figure 20).

### **⚠ IMPORTANT**

**The unit is not designed for and will not work with the Harmony zone control system.**

#### COOL (single-stage systems)

The **COOL** jumper is used to determine the CFM during cooling operation. This jumper selection is activated for cooling when Y1 is energized. A factory-installed jumper from Y1 to Y2 allows single-stage cooling.

The blower motor runs at 82% CFM for the first 7-1/2 minutes of each cooling demand to allow for greater humidity removal and to conserve energy. If, after 7-1/2 minutes, the Y demand is not met, 100% CFM is supplied until the demand is satisfied.

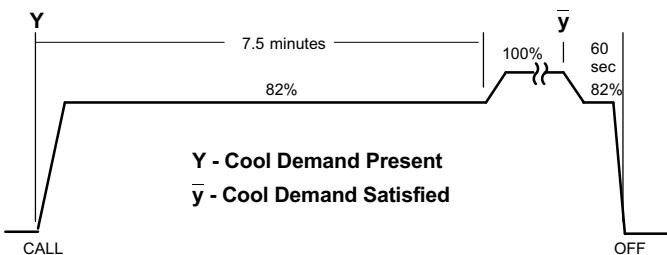

When the demand for cool is met, the blower ramps down to 82% CFM for 60 seconds, then turns off.

#### COOL (two-stage systems)

This unit is factory-wired for single-stage cooling. For two-stage cooling operation, you must cut the jumper wire from Y1 to Y2 on the A54 blower control. Cut the jumper close to the Y1 terminal to allow a pigtail connection with the remaining wire from the Y2 terminal and a wire connected to the Y2 terminal of the two-stage thermostat. Refer to field wiring diagrams.

A thermostat call for first-stage cooling closes the R to Y1 circuit on the A54 blower control. The blower motor runs at 57% CFM for the first 7-1/2 minutes of the 1st-stage cooling demand. After 7-1/2 minutes, the blower motor runs at 70% CFM until the first-stage demand is satisfied.

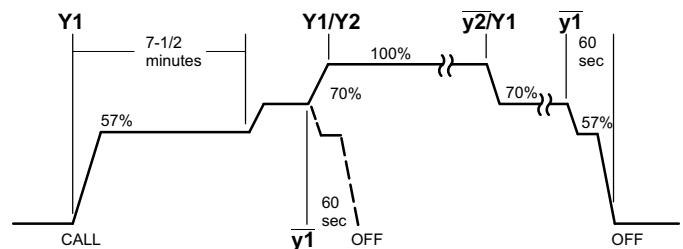

**Y1 - 1st-stage COOL Demand Present**  
**y1 - 1st-stage COOL Demand Satisfied**  
**Y2 - 2nd-stage COOL Demand Present**  
**y2 - 2nd-stage COOL Demand Satisfied**

If first-stage cooling does not satisfy the demand, the thermostat calls for 2nd-stage cooling, closing the R to Y2 circuit on the A54 blower control. The blower motor ramps up to 100% CFM.

When the Y2 demand is met, the blower ramps down to Y1 at 70% CFM until Y1 is met, and ramps down to 57% CFM for 1 minute, then turns off.

#### Heat Pump

### **⚠ IMPORTANT**

**For heat pump operation, cut the jumper between R and O near the R terminal of A54 and connect the pigtail to the thermostat O wire (A54 board "O" to thermostat "O"). See figure 19.**

In heat pump mode, a call for heat pump operation follows the same sequence as a call for cooling, with the exception that there is a 30-second blower ramp-up to blower CFM.



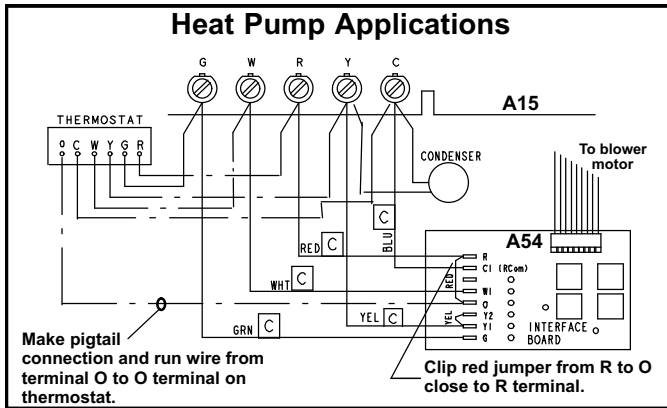

Figure 19

## ADJUST

The **ADJUST** pins affect blower motor speed during cooling operation only. The ADJUST feature allows the motor to run at normal speed, approximately 15% higher than normal speed, or 15% lower than normal speed during the cooling mode. Table 7 gives three rows—NORM, (+), and (–) with their respective CFM volumes. Notice that the normal “NORM” adjustment setting for cool speed position C in table 7 is 800 CFM. The “(+)” adjustment setting for that position is 920 CFM (115% of 800 CFM) and the “(–)” adjustment setting is 680 CFM (85% of 800 CFM). After the adjustment setting has been determined, choose the remaining speed settings from those offered in the table in that row.

## HEAT

The unit is factory-set to run at the middle of heating rise range as shown on the unit rating plate. The jumper on the tap marked **HEAT** must remain in the position given in table 7.

The **HEAT** jumper is used to determine CFM during heating operation only. These jumper selections are activated only when W1 is energized.

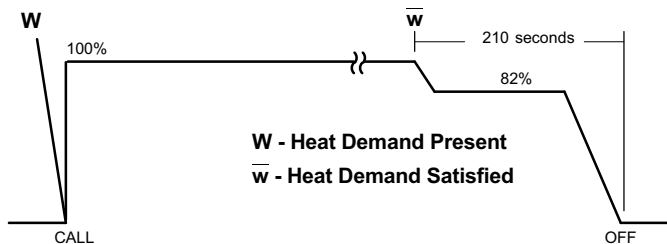

When the demand for heat is met, the blower ramps down to 82% CFM for 3-1/2 minutes, then turns off.

## TEST

The TEST pin is available to bypass the blower control and run the motor at approximately 70% to make sure that the motor is operational. This is used mainly in troubleshooting. The G terminal must be energized for the motor to run.

## CFM LED

The **CFM** LED located on the blower control flashes one time per 100 cfm to indicate selected blower speed. For example, if the unit is operating at 1000 CFM, the **CFM** LED will flash 10 times.

At times, the light may appear to flicker or glow. This takes place when the control is communicating with the motor between cycles. This is normal operation.

After the CFM for each application has been determined, the jumper settings must be adjusted to reflect those given in table 7. From the table, determine which row most closely matches the desired CFM. Once a specific row has been chosen (+, NORMal, or -), CFM volumes from other rows cannot be used. Below are descriptions of the jumper selections.

The variable speed motor slowly ramps up to and down from the selected air flow during both cooling and heating demand. This minimizes noise and eliminates the initial blast of air when the blower is initially energized.

## Continuous Fan

When the thermostat is set for “Continuous Fan” operation and there is no demand for heating or cooling, the blower control will provide 50% of the **COOL** CFM selected.

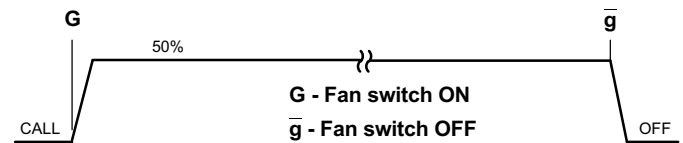

*NOTE - With the proper thermostat and subbase, continuous blower operation is possible by closing the R to G circuit.*

## Dehumidification

The A54 blower control (see figure 20) includes a HUM terminal which provides for connection of a humidistat. The JW1 jumper on the blower control must be cut to activate the HUM terminal. The humidistat must be wired to open on humidity rise. When the dehumidification circuit is used, the variable speed motor will reduce the selected air flow rate by 18% when humidity levels are high. An LED (D1) lights when the blower is operating in the dehumidification mode.

## Humidification

Terminals are provided on the A15 control for 120 volt output to operate a humidifier. The “HUM” terminal is energized when there is a call for heat. See figure 22.

## Indoor Air Quality (IAQ) Accessory

An EAC terminal is provided on the A15 control for 120 volt output to an indoor air quality accessory. The EAC terminal is energized when there is a call for heat, cool, or continuous blower. See figure 22.

Table 7

**BLOWER DATA**

**SLO185UF79/105V42 BLOWER PERFORMANCE**  
0 through 0.50 in. w.g. External Static Pressure Range

"ADJUST" Jumper Setting	Jumper Speed Positions					
	"HEAT" Speed		"COOL" Speed			
	.65 High Fire	.50 Low Fire				
	A	D	A	B	C	D
	cfm	cfm	cfm	cfm	cfm	cfm
+	N/A	N/A	1500	1400	1200	1000
NORM	1500	1200	1400	1200	1000	800
-	N/A	N/A	1200	1000	900	650

NOTE - Continuous Fan air volume is 50% of COOL speed.

**SLO185UF124/141V60 BLOWER PERFORMANCE**  
0 through 0.50 in. w.g. External Static Pressure Range

"ADJUST" Jumper Setting	Jumper Speed Positions					
	"HEAT" Speed		"COOL" Speed			
	.85 High Fire	.75 Low Fire				
	A	C	A	B	C	D
	cfm	cfm	cfm	cfm	cfm	cfm
+	N/A	N/A	2000	2000	1800	1400
NORM	1850	1550	2000	1800	1600	1250
-	N/A	N/A	1700	1550	1400	1050

NOTE - Continuous Fan air volume is 50% of COOL speed.

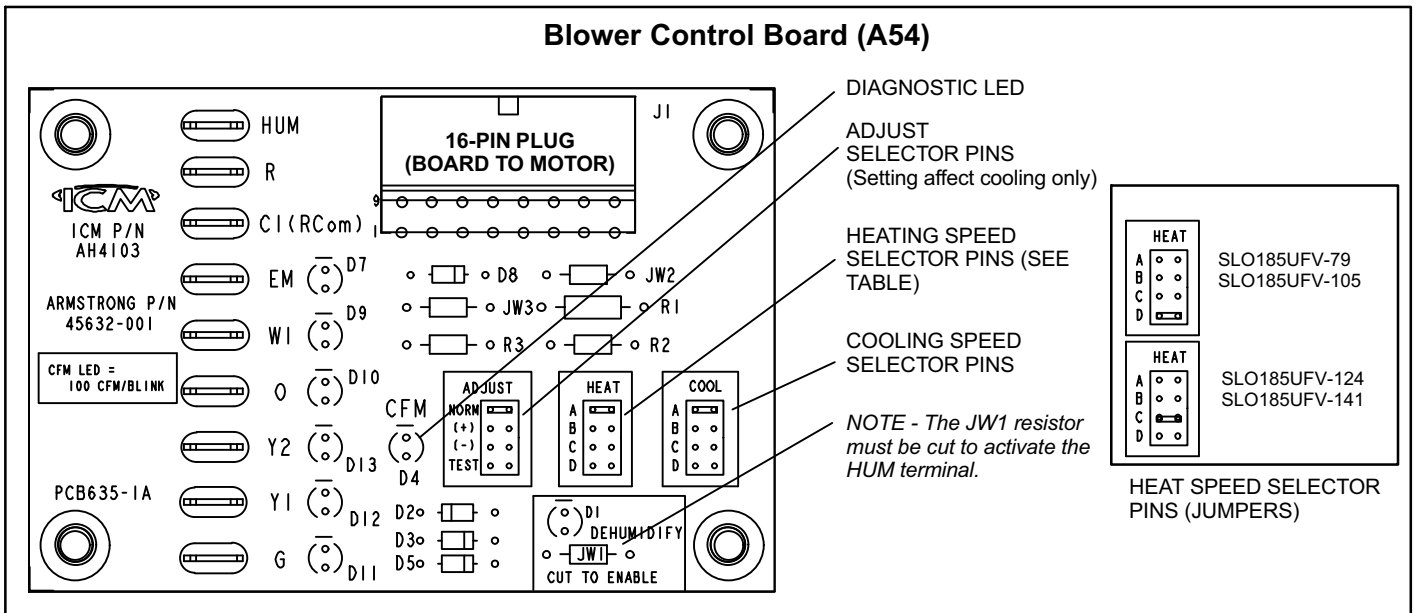

Figure 20

## Unit Start-Up & Adjustments

Before starting unit, make sure the oil tank is adequately filled with clean No. 1 or No. 2 furnace oil.

*NOTE - Water, rust or other contaminants in oil supply system will cause malfunction and failure of the internal parts of the fuel pump.*

### CAUTION

**Never burn garbage or paper in the heating system. Never leave papers near or around the unit.**

### CAUTION

**Blower access door must be in place before start-up.**

#### Burner Start-Up

- 1 - Set thermostat for heating demand and turn on electrical supply to unit.
- 2 - Open all shut-off valves in the oil supply line to the burner.
- 3 - While the ignition is on, press and release the reset button on the burner control (hold 1/2 second or less). If the control has not locked out since its most recent complete heat cycle, the lockout time will be extended to 4 minutes and the ignition will remain on for the entire heat cycle.
- 4 - Bleed the pump until all froth and bubbles are purged. The bleed port is located on the bottom of the fuel pump. To bleed, attach a clear plastic hose over the vent plug. Loosen the plug and catch the oil in an empty container. Tighten the plug when all the air has been purged.  
*NOTE - A two-line fuel system will normally bleed itself by forcing air back to the tank through the return line. This type of bleeding procedure is not necessary.*
- 5 - If burner fails to start within the set time, the burner control will lock out operation. Press the reset button to reset the control as in step 3. See figure 3 on page 3 for burner parts arrangement.

*NOTE - The reset button can be held for 15 seconds for the Beckett 7505B primary control, at any time to reset the controls lockout counter to zero and send the control to standby.*

### CAUTION

**Do not push the reset button on the primary control more than one time.**

- 6 - Repeat steps 4 and 5, if necessary, until pump is fully primed and oil is free of bubbles. Then, terminate the call for heat. The burner control will resume normal operation

#### Fuel Pump Pressure Adjustment

Measure fuel pump pressure with unit off. Attach pressure gauge to pump outlet. Turn unit on and check pressure and compare to table 9. Adjust if necessary.

#### Temperature Rise Adjustment

To measure temperature rise, place plenum thermometers in warm air and return air plenums. Locate thermometer in warm air plenum where thermometer will not "see" the heat exchanger to prevent it from picking up radiant heat. Set thermostat to its highest setting to start unit. After plenum thermometers have reached their highest and steadiest readings, subtract the readings. The difference in temperatures in the supply and return air plenums should approximate the temperatures listed in table 8 and on the appliance rating plate.

If the temperature rise is not within the range listed, check the following items:

- Make sure that properly sized nozzle has been used (table 9).
- Make sure that fuel pump pressure is correct.
- If furnace is in cutback mode, check for:  
Dirty filters,  
Dirty indoor coil,  
Restricted ducts, closed registers, etc.

**Table 8  
Temperature Rise**

Unit	Temperature Rise °F
SLO185UFV79	45 - 55
SLO185UFV105	45 - 55
SLO185UFV124	55 - 65
SLO185UFV141	55 - 65

#### Limit Control

Limit Control — Do not adjust from factory setting.

#### Combustion Check and Burner Adjustment

The following instructions are essential to the proper operation of SLO185UFV series oil furnaces. Refer to table 9 for nozzle and pump pressure information. The proper way to adjust an oil burner is with a CO<sub>2</sub> analyzer and smoke gun. A properly adjusted burner will result in a quiet, clean fire which will prevent sooting and minimize cleaning. Using the following procedure will provide a margin of reserve air to accommodate variable conditions.

1. Punch a 5/16" diameter service hole in the flue outlet. This sampling hole should be at least two flue diameters above the breech, or elbow at the breech, but ahead of the barometric damper.
2. Operate burner for approximately 5 to 10 minutes.

**Table 9  
Burner Specifications**

Unit	Burner Number	Beckett Spec. No.	Beckett Air Tube Part No.	Input Rating BTU/HR	Nozzle Size, Spray, Angle, & Pattern	Pump Pressure	Head	Insertion Length	Static Plate Diameter
SLO185UFV-79/105	103880-01	ARM2201	NX70LH-HS	79,000	0.50gph x 60°A hollow	150	6 Slot	5"	3.00"
SLO185UFV-79/105	103880-01	ARM2201	NX70LH-HS	105,000	*0.65gph x 60°A hollow	150	6 Slot	5"	3.00"
SLO185UFV-124/141	103880-02	ARM2202	NX70LCHS	124,000	0.75gph x 60°A hollow	145	6 Slot	5"	3.25"
SLO185UFV-124/141	103880-02	ARM2202	NX70LCHS	141,000	*0.85gph x 60°A hollow	145	6Slot	5"	3.25"

\*Nozzle must be field-installed for conversion to higher heating input.  
NOTE - All nozzles are Delavan brand.

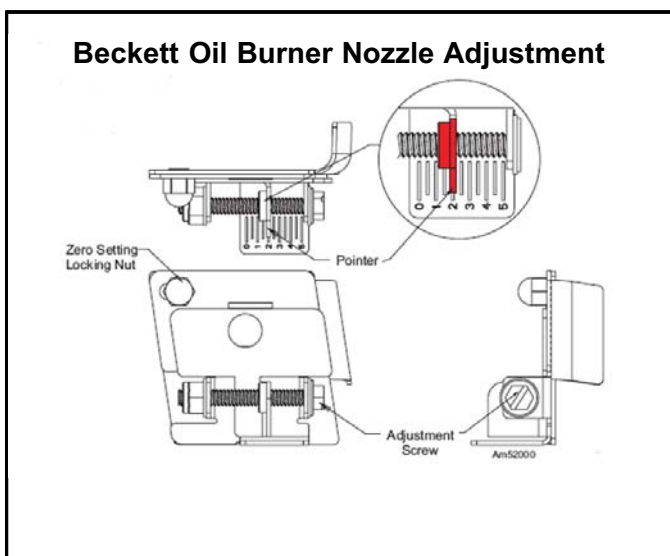

**Figure 21**

3. Take a draft reading at the service hole in the flue outlet. Adjust barometric draft control in the stack to achieve an overfire draft of  $-0.1''$  to  $-0.02''$  and a breach of  $-0.2$  to  $-0.04''$ .
4. Pull and record a smoke reading at the service hole using an industry standard smoke tester.
5. If the burner is producing more than #1 smoke, adjust the intake air using the zero setting locking nut and adjustment screw (figure 21). Loosen the locking nut approximately one turn. Turn the adjustment screw clockwise to increase air or counterclockwise to decrease air.
6. Once the desired smoke level is achieved, use a suitable test instrument and take a CO<sub>2</sub> sample at the service hole in the flue outlet (from step 1).
7. Adjust the air from step 5 to achieve the desired CO<sub>2</sub> level.
8. Recheck smoke level.
9. Recheck draft and CO<sub>2</sub> reading at the service hole.
10. Using a suitable thermometer, obtain and record the flue gas temperature at the service hole.
11. Use the CO<sub>2</sub> reading and the flue gas temperature reading to determine unit efficiency.

12. When proper combustion and smoke readings have been achieved, tighten the zero setting lock nut and adjustment screw.

**Service**

**⚠ CAUTION**  
Do not tamper with unit controls. Call your qualified service technician.

**Servicing the Air Filter**

NOTE - Under no circumstances should the access panels to the blower compartment be left off or left partially open.

**Throw-Away Type Filters**—Check filters monthly and replace when necessary to assure proper furnace operation. Replace filters with like kind and size filters.

**Reusable Type Filters**—Filters should be checked monthly and cleaned when necessary to assure proper furnace operation. Use warm water and a mild detergent. Replace filter when dry. Permanent filters supplied with SLO185UFV furnaces do not require oiling after cleaning. Examine filter label for any special instructions that may apply.

**⚠ IMPORTANT**

If a high-efficiency filter is being installed as part of this system to ensure better indoor air quality, the filter must be properly sized. High-efficiency filters have a higher static pressure drop than standard-efficiency glass/foam filters. If the pressure drop is too great, system capacity and performance may be reduced. The pressure drop may also cause the limit to trip more frequently during the winter and the indoor coil to freeze in the summer, resulting in an increase in the number of service calls.

Before using any filter with this system, check the specifications provided by the filter manufacturer against the data given in the appropriate Lennox Product Specifications bulletin. Additional information is provided in Service and Application Note ACC-00-2 (August 2000).

## Servicing the Blower

Blower motor is prelubricated and sealed for extended operation. No further lubrication is required. Disconnect power to unit before cleaning blower wheel for debris.

## Inspecting the Flue Pipe

The flue pipe should be inspected annually by a qualified service technician. Remove and clean any soot or ash found in the flue pipe. Inspect pipe for holes or rusted areas. If replacement is necessary, replace with the same size and type as required by code. Inspect the flue draft control device and replace if found defective.

## Cleaning the Heat Exchanger

1. Remove the vent pipe from the furnace.
2. Remove the locking screws and the caps from the clean out tubes. Remove flue access elbow.
3. Using a long spiral wire brush, sweep down the outer drum of the heat exchanger. Then using the hose attachment, vacuum out loose debris.
4. Remove the locking screw and cap from the observation tube and with the spiral wire brush, reach upward toward the rear of the heat exchanger to clean out the crossover tube.

## CAUTION

**Do not attempt to clean the combustion chamber. It can be easily damaged.**

5. Replace the three clean out caps and flue access elbow. Make sure locking screws are secure.
6. Brush out and vacuum the vent outlet area of the outer drum and replace vent pipe.
7. Clean around the burner, blower deck and vestibule area.

*NOTE - A heat exchanger clean-out kit ABRSH380 (35K09) is available from Lennox. The Kit includes one radiator brush (which consists of a tapered brush with a 36" spiral wire handle).*

## GeniSys™ Primary Burner Control

SLO185UFV units are equipped with the Beckett GeniSys™ 7505B primary burner control. The control is positioned on the upper right-hand side of the Beckett NX burner assembly. The control includes a reset button and three

status lights. See figure 22 for location of reset buttons and status lights. Table 10 details reset button operation. Table 11 details status light function.

Additional information on the GeniSys™ 7505B primary burner control is provided with this furnace.

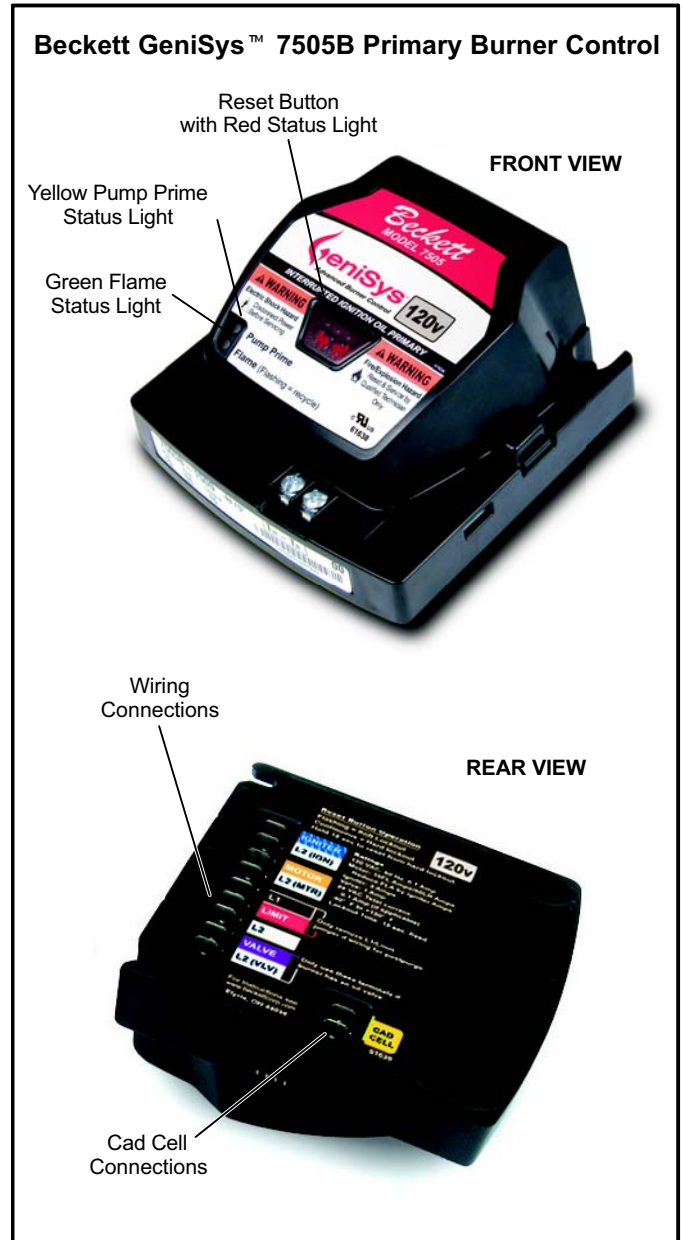

Figure 22

**Table 10  
Reset Button Operation**

If the burner is in the below state:	Pushing the reset button will:		
	Button Click (press < 1 second)	Button Hold (press > 1 second)	Button Hold (press 15+ seconds)
Lockout	Reset from Soft Lockout		Reset from Restricted (Hard) Lockout
Valve-on Delay, Trial for Ignition, Ignition Carryover	Go to pump prime (see "Priming the Pump" above)	Disable the Burner: Any time the burner is running, press and hold the reset button to disable the burner. The burner will remain off as long as the button is held.	Enables pump priming After the reset button has been held for 15 seconds. The button can then be clicked during the next ignition sequence to enter pump prime mode.
Run (igniter is shut off)	No action		
	No action		
Pump Prime	No action	Exit Pump Prime mode and return to Standby	

**Table 11  
Status Light Function**

Light Color	On Continuously	Flashing
Red	Restricted (Hard) Lockout	Soft Lockout
Green	Flame Sensed during normal operation (Could be stray light during standby)	Recycle
Yellow	Control is in pump prime mode <i>or</i> Reset button currently held for 15+ seconds.	N/A

### Heating Sequence - Actions & Responses

**1. Action: Thermostat calls for heat** (W terminal is energized)

Response:

- ST9103A control (A15) closes oil primary control TR-TW contacts.
- After 15-second prepurge, power is sent to the oil delay valve, ignition occurs and flame is established.
- Ignition sequence continues for 10 seconds after flame is sensed. Oil will continue to flow as long as cad cell senses flame.
- Heat fan on ramp timing begins. When timing is complete, the indoor blower is at heat speed and warm air is delivered to the controlled space.

**2. Action: Thermostat ends call for heat** (W terminal is de-energized)

Response:

- After the thermostat is satisfied, the thermostat circuit opens. The oil delay valve and burner are de-energized.
- Burner is de-energized.
- Heat fan off ramp timing begins. When timing is complete, indoor blower is de-energized.
- Blower control returns to standby mode (oil primary control and indoor blower are off).

**3. Action: Burner fails to light**

Response:

- Oil primary control enters soft lockout after ignition failure (15 seconds without flame being sensed). Push reset button on primary control for one second to reset soft lockout.

- After soft lockout reset, oil primary control allows second ignition attempt. Primary control enters hard lockout after second ignition failure (15 seconds without flame being sensed). Push reset button on primary control for 15 seconds until light on control turns yellow to reset hard lockout.

**4. Action: Established flame fails**

Response:

- Burner motor is de-energized.
- Burner motor is de-energized and oil primary control goes into recycle mode.
- If the fan off delay is longer than the recycle timing, the indoor blower continues to run on heating speed through the next trial for ignition.

**5. Action: Limit Switch Opens**

Response:

- Oil primary control de-energizes burner.
- Indoor blower is energized immediately at cool speed.
- A15 control opens oil primary control TR-TW contacts.
- Indoor blower runs as long as limit stays open.

**6. Action: Limit Switch Closes**

Response: If there is a heating demand, A15 control energizes oil primary control and ignition sequence begins.

### Troubleshooting

Burner failure or improper operation can result from a number of different causes. Often the cause can be pinpointed by observing the different types of failure or by the process of elimination. The following troubleshooting charts list some failures, causes and a sequence of steps to isolate the point of failure. Check the simplest and most obvious items before progressing to other items.

## Troubleshooting: Blower Control Operating Sequence

Action	System Response
Thermostat calls for heat. (W terminal is energized.)	ST9103A closes oil primary control TR-TW contacts. Ignition system and oil primary control start the furnace. Oil flows as long as cad cell senses flame. Call for heat energizes burner motor and blower ramping begins for heating mode. When ramping is complete, the indoor blower is energized at heat speed and warm air is delivered to the controlled space.
Thermostat ends call for heat. (W terminal is de-energized.)	Oil primary control is de-energized, terminating the burner cycle. Heat fan off delay timing begins. When timing is complete, the indoor blower is de-energized. ST9103A returns to standby mode (oil primary control and circulating fan are off).
Burner fails to light.	Oil primary control locks out within lockout timing (timing depends on oil primary control). Burner motor is de-energized. If heat fan has started, it continues through the selected delay off period.
Established flame fails.	Burner motor is de-energized and oil primary control goes into recycle mode. If selected heat fan off delay is longer than the recycle delay timing, the heat fan continues to run through the next trial for ignition.
Thermostat begins call for cool. (G and Y terminals are energized.)	Indoor blower is energized at the cool speed. Cooling compressor turns on immediately.
Thermostat ends call for cool. (G and Y terminals are de-energized.)	Cooling compressor turns off immediately and indoor blower speed ramps down. Circulating fan shuts off after 60 seconds.
Thermostat begins call for fan. (G terminal is energized.)	Indoor blower is energized immediately at 50% of cool speed. ST9103A may be factory-configured to operate heat speed in this mode.
Thermostat ends call for fan. (G terminal is de-energized.)	Indoor blower is de-energized.
Limit switch string opens.	Oil primary control shuts off the burner. Indoor blower is energized immediately at heat speed. ST9103A opens oil primary control TR-TW contacts. Indoor blower runs as long as limit string stays open. If there is a call for cooling or fan, the indoor blower switches from heat speed to cool speed.
Limit switch string closes.	ST9103A begins heat fan off delay sequence. Indoor blower turns off after the selected heat fan off delay timing. ST9103A closes oil primary control TR-TW contacts. Oil primary control is energized, initiating burner ignition.
Continuous circulating fan is connected. (Optional connectors are available for separate circulating fan speed tap.)	Indoor blower is energized at 50% of cool speed when there is no call for heat, cool or fan. If fan operation is required by a call for heat, cool, or fan, the ST9103A switches off the continuous fan speed tap before energizing the other fan speed.
IAQ accessory is connected. (Optional connectors are available for 120 Vac accessories.)	EAC terminals (for IAQ accessories) are energized when the indoor blower is energized in either the heat or cool speed. EAC terminals are <i>not</i> energized when the optional continuous fan terminal is energized.
Humidity control is connected. (Optional connectors are available for 120 Vac humidifier.)	Humidifier connections are energized when the burner motor is energized.

## Troubleshooting: Burner fails to start.

Source	Procedure	Causes	Correction
Thermostat	Check thermostat settings.	Thermostat in <b>OFF</b> or <b>COOL</b>	Switch to <b>HEAT</b> .
		Thermostat is set too low	Turn thermostat to higher temperature.
Safety Overloads	Check burner motor, primary safety control, & auxiliary limit switch.	Burner motor overload tripped	Push reset button pump motor.
		Primary control tripped on safety	Reset primary control.
		Auxiliary limit switch tripped on safety	Reset auxiliary limit.
Power	Check furnace disconnect switch & main disconnect.	Open switch	Close switch.
		Blown fuse or tripped circuit breaker	Replace fuse or reset circuit breaker.
Thermostat	Touch jumper wire across TR-TW terminals on primary control. If burner starts, then fault is in the thermostat circuit.	Broken or loose thermostat wires	Repair or replace wires.
		Loose thermostat screw connection	Tighten connection.
		Dirty thermostat contacts	Clean contacts.
		Thermostat not level	Level thermostat.
		Faulty thermostat	Replace thermostat.
		Open circuit in wiring between ST9103A and oil primary control.	Check wiring between ST9103A and oil primary control.
Cad Cell	Disconnect the flame detector wires at the primary control. If the burner starts, fault is in the detector circuit.	Flame detector leads are shorted	Separate leads.
		Flame detector exposed to light	Seal off false source of light.
		short circuit in the flame detector	Replace detector.
Primary Control	Place trouble light between the orange and white leads. No light indicates that no power is going to the control.	Primary or auxiliary control switch is open	Check adjustment. Set the maximum setting. Jumper terminals; if burner starts, switch is faulty, replace control.
		Open circuit between disconnect switch and limit control	Trace wiring and repair or replace it.
		Low line voltage or power failure	Call the power company.
	Place trouble light between the orange and white leads. No light indicates faulty control.	Failed internal control circuit	Replace the control.
Burner	Place the trouble light between the orange and white leads to the burner motor. No light indicates that no power is getting to the motor.	Blown fuse	Replace the fuse.
	Place trouble light between the black and white leads to the blower motor. Light indicates power to the motor and burner fault.	Binding burner blower wheel	Turn off power and rotate the blower wheel by hand. If seized, free the wheel or replace the fuel pump.
		Seized fuel pump	
		Failed burner motor	Replace the motor.



## Troubleshooting: Burner starts, but no flame is established.

Source	Procedure	Causes	Correction
Oil Supply	Check tank gauge or use dip stick.	No oil in tank	Fill tank.
	Coat dip stick with litmus paste and insert into bottom of tank.	Water in oil tank	If water depth exceeds 1 inch, pump or drain water.
	Listen for pump whine.	Tank shut-off valve closed	Open valve.
Oil Filters & Oil Line	Listen for pump whine.	Oil line filter is plugged	Replace filter cartridges.
		Kinks or restriction in oil line	Repair or replace oil line.
		Plugged fuel pump strainer	Clean strainer or replace pump.
	Open bleed valve or gauge port. Start the burner. No oil or milky oil indicates loss or prime.	Air leak in oil supply line	Locate and correct leak. Tighten all connections.
Oil Pump	Install pressure gauge on pump and read pressure. Should not be less than 140 psi.	Pump is partially or completely frozen. No pressure and the motor locks out on overload.	Replace pump.
		Coupling disengaged or broken - no pressure	Re-engage or replace coupling.
		Fuel pressure too low	Adjust -79/105 to 150 psi. Adjust -124/141 to 145 psi.
Nozzle	Observe the oil spray (gun assembly must be removed from unit). Inspect the nozzle for plugged orifice or carbon build-up around orifice.	Nozzle orifice plugged	Replace nozzle with the same size, spray angle, and spray pattern.
		Nozzle strainer plugged	
		Poor or off center spray	
Ignition Electrodes	Remove gun assembly and inspect electrodes.	Fouled or shorted electrodes	Clean or replace electrodes.
		Dirty electrodes	
		Eroded electrode tips	Clean electrode tips and use T-501 gauge to reset the gap to 5/32 inches and correctly position tips.
		Improper electrode gap spacing	
		Improper position of electrode tips	
		Bad buss bar connection	Retension and realign.
Cracked or chipped insulators	Replace electrode.		
Ignition Transformer	Start burner and observe spark. Check line voltage to transformer primary.	Low line voltage	Check voltage at power source. Correct cause of voltage drop or call the power company.
		Burned out transformer windings.	Replace the transformer.
		No spark or weak spark	Properly ground the transformer case.
Burner Motor	Motor does not come up to speed and trips out on overload. Turn off power and rotate blower wheel by hand to check for binding or excessive drag.	Low line voltage	Check voltage at power source. Correct cause of voltage drop or the call power company.
		Pump or blower overloading motor	Correct cause of overloading.
		Faulty motor	Replace motor.

### Troubleshooting: Burner starts and fires, but lock out on safety.

Source	Procedure		Causes	Correction
Poor Fire		If burner continues to run, this may be due to poor fire. Inspect fire.	Unbalanced fire	Replace nozzle
			Too much air - -lean short fire	Reduce combustion air - check combustion.
			Too little air - - long dirty fire	Increase combustion air - check combustion.
			Excessive draft	Adjust barometric draft control for correct draft.
			Too little draft or restriction	Correct draft or remove restriction.
Flame Detector	After burner fires, immediately jumper across flame detector terminals at the primary control.	If fire is good, fault is in the flame detector. Check detector circuit.	Faulty cad cell (open circuit)	Replace cad cell.
			Loose connections or broken cad cell wires	Secure connections or replace cad cell holder and wire leads.
			Cad cell cannot sense flame	Check cad cell for proper alignment. Check cad cell face and clean, if necessary.
Primary Control		If burner locks out on safety, fault is in the primary control.	Primary control circuit failed	Replace primary control.

### Troubleshooting: Burner Starts and Fires, but Loses Flame and Lock Out on Safety

Source	Procedure		Causes	Correction
Poor Fire		If burner continues to run (does not lock out of safety), fault may be due to poor fire. Inspect fire.	Unbalanced fire	Replace nozzle
			Too much air - - lean short fire	Reduce combustion air - check combustion.
			Too little air - - long dirty fire	Increase combustion air - check combustion.
			Excessive draft	Adjust barometric draft control for correct draft.
			Too little draft or restriction	Correct draft or remove restriction.
Flame Detector	After burner fires, immediately jumper across flame detector terminals at the primary control.	If fire is good, fault is in the flame detector. Check detector circuit.	Faulty cad cell (open circuit)	Replace cad cell.
			Loose connections or broken cad cell wires	Secure connections or replace cad cell holder and wire leads.
			Cad cell cannot sense flame	Check cad cell for proper alignment. Check cad cell face and clean, if necessary.
Oil Supply		If burner loses flame (does not lock out on safety), fault is in the fuel system.	Pump loses prime - air slug	Prime pump at bleed port
			Pump loses prime - air leak in supply line	Check supply line for loose connections and tighten fittings.
			Water slug in line	Check oil tank for water (over 1 inch) pump or drain out water.
			Partially plugged nozzle or nozzle strainer	Replace nozzle.
	Listen for pump whine	Restriction in oil line	Clear restriction.	
		Plugged fuel pump strainer	Clean strainer or replace pump.	
		Cold oil - outdoor tank	Change to number 1 oil.	

**Troubleshooting: Burner starts and fires, but short cycles (too little heat)**

Source	Procedure	Causes	Correction
Thermostat	Check thermostat.	Heat anticipator set too low	Correct heat anticipator setting.
		Vibration at thermostat	Correct source of vibration.
		Thermostat in the path of a warm air draft	Shield thermostat from draft or relocate.
Limit Control	Connect voltmeter between line voltage connections to primary control (black & white leads). If burner cycles due to power interruption, it is cycling on limit.	Dirty furnace air filters	Clean or replace filter.
		Temperature rise too high	Check for proper nozzle size. Replace nozzle, if necessary. Check for restrictions and remove, if necessary. Check speed tap jumper and make sure it is still in factory position.
		Blower motor seized or burned out	Replace motor.
		Blower wheel dirty	Clean blower wheel.
		Wrong motor rotation	Replace motor.
		Restrictions in return or supply air system	Correct cause of restriction.
Power	If voltage fluctuates, fault is in the power source. Recheck voltage at the power source.	Loose wiring connection	Locate and secure connection.
		Low or fluctuating line voltage	Call power company.

**Troubleshooting: Burner runs continuously (too much heat).**

Source	Procedure		Causes	Correction
Thermostat	Disconnect thermostat wires at the primary control.	If burner turns off, fault is in the thermostat circuit.	Shorted or welded thermostat contacts	Repair or replace the thermostat.
			Stuck thermostat bimetal	Clear obstruction or replace thermostat.
			Thermostat not level	Level thermostat.
			Shorted thermostat wires	Repair short or replace wires.
			Thermostat out of calibration	Replace thermostat.
			Thermostat in cold draft	Correct draft or relocate the thermostat.
Primary control		If burner does not turn off, fault is in the primary control.	Failed primary control	Replace the primary control.

**Troubleshooting: Burner runs continuously (too little heat).**

Source	Procedure		Causes	Correction
Combustion	Check burner combustion for CO <sub>2</sub> , stack temperature, and smoke	Low CO <sub>2</sub> less than 10%.	Too much combustion air	Reduce combustion air.
			Air leaks into heat exchanger around inspection door, etc.	Correct cause of air leak.
			Excessive overfire draft	Adjust barometric draft control for correct draft.
			Incorrect nozzle assembly depth	Set to 1.13.
		High smoke reading more than a trace.	Dirty or plugged heat exchanger	Clean heat exchanger. Readjust burner.
			Insufficient overfire draft	Increase draft.
			Incorrect nozzle assembly depth	Set to 1.13.
			Too little combustion air	Increase combustion air.
		High stack temperature is more than 550°F Net.	Low volume indoor blower air	Check pump coupling for wear / slippage.
			Dirty heat exchanger	Clean heat exchanger.
			Dirty burner blower wheel	Clean burner blower wheel.
			Dirty furnace air filters	Clean or replace filter.
Restricted or closed registers or dampers	Readjust registers or dampers.			
Oil Pressure	Inspect fire and check oil pressure.		Partially plugged or bad nozzle	Replace nozzle.
			Oil pressure is too low (less than 140 psi.)	Increase oil pressure to 140 psi.