



Installation and Setup Guide

Color Touchscreen
Programmable Commercial
Thermostat

ComfortSense® 7500

Model: C0STAT06FF1L

Cat: 13H15

507506-01

12/2016

Supersedes 3/2016

Table of Contents

Shipping and Packing List	2
ComfortSense® 7500 Thermostat	2
Features	3

INSTALLATION

Installing Thermostat	5
Wiring Thermostat	9

SETTINGS

Menu	10
Installer Settings	10
Dehumidify	29
Unit Part (Catalog) and Serial Number	33
Memory Protection	33
Appendix A. Humiditrol	35
Appendix B. Diagnostic Information	35
Appendix C. Reminder Information	38
Appendix C. Supported Configurations	39
Appendix D. Installer Checklist	41

Shipping and Packing List

- 1 - ComfortSense® 7500 touchscreen, 7-day programmable thermostat with back plate
- 1 - Wall plate
- 2 - Mounting screws (M3.5x25mm self-tapping screws)
- 2 - Wall anchors
- 1 - Warranty sheet
- 1 each - User and Installer Guides



IMPORTANT

Read this manual before programming the thermostat. Use this thermostat only as described in this manual.

ComfortSense® 7500 Commercial Thermostat (C0STAT06FF1L) (Catalog No. 13H15)

Description

The ComfortSense® 7500 commercial thermostat (C0STAT06FF1L) is an electronic 7-day universal

multi-stage programmable touch screen thermostat. It also offers enhanced capabilities which include:

- dehumidification measurement and control,
- equipment maintenance reminders,
- worry-free memory storage feature,
- menu-driven touch-screen display.

This thermostat supports heat pumps (single or two stage) or non-heat pump units, with up to:

- two auxiliary stages
- two stages of heating and two stages of cooling.

Unit Dimensions (H x W x D)

Case dimensions: 3-5/16 x 4-5/16 x 7/8 in. (84 x 110 x 22mm)

Wall Plate Dimensions (H x W)

Plate dimensions: 4-1/2" x 5-3/4" (114 x 146mm)

Features

Compressor Short Cycle Protection

This thermostat is equipped with automatic compressor protection to prevent potential

damage due to short cycling or extended power outages. The short-cycle protection provides a 5-minute delay between heating or cooling cycles to prevent the compressor from being damaged.

A 5-minute compressor short cycle protection timer begins when a compressor output is de-energized. Also, if a power loss occurs, the system will go into compressor protection mode and display "waiting" next to either a snow flake (compressor cooling), or flame (compressor heating) in the display.

Internal and External Temperature Sensors

See information starting on page 11 for sensor wiring and configuring sensor settings under Installer Settings menu.



IMPORTANT

All remote sensors use standard non-shielded thermostat wire.



WARNING

Improper installation, adjustment, alteration, service or maintenance can cause property damage, personal injury or loss of life.

Installation and service must be performed by a licensed professional HVAC installer (or equivalent) or service agency.



CAUTION

This is a 24VAC low-voltage thermostat. Do not install on voltages higher than 30VAC.

Do not short (jumper) across terminals on the gas valve or at the system control to test installation. This will damage the thermostat and void the warranty.



IMPORTANT

In all applications, the ComfortSense® Model 7500 thermostat can only be used with all residential units and approved commercial split-system matches, and those which meet the following installation criteria:

- installation uses 18 GAUGE thermostat wire or larger,
- thermostat wire run length DOES NOT EXCEED 300' (91m),
- load from any thermostat connection is 1 AMP or LESS.



CAUTION

Always turn off power at the main power source by switching the circuit breaker to the OFF position before installing or removing this thermostat.

All wiring must conform to local and national building and electrical codes and ordinances.

THERMOSTAT INSTALLATION

Before beginning installation, note the type of equipment, number of stages, and any accessories being installed. This thermostat is a 24VAC low-voltage thermostat and requires a common wire to the thermostat to operate.

DO

1. Shut off all power to system before installing.
2. Read this entire document, noting which instructions pertain to your equipment and system requirements.
3. Make sure that all wiring conforms to local and national building and electrical codes and ordinances.
4. Use thermostat wire between the thermostat and any optional remote temperature sensor (may be separate wire pair or two wires of a multi-wire cable for outdoor temperature sensor).
5. Ensure load from any thermostat connection is less than 1 AMP.

DO NOT

1. Install On voltages higher than 30VAC.

2. Short (jumper) across terminals on the gas valve or at the system control to test installation. This will damage the thermostat and void the warranty.
3. Install on outside walls or in direct sunlight.
4. Exceed thermostat wire run length greater than 300 feet (91m).

INSTALLING THERMOSTAT

1. Unpacked the thermostat and open the case with a thin-blade screwdriver. Place between wall base and unit and twist to separate unit from base.
2. Select a location for the thermostat about 5 feet (1.5m) above the floor in an area with good air circulation at average temperature.
3. Do not install the thermostat where it can be affected by:
 - Drafts or dead spots behind doors and in corners.
 - Not close to entrance or automatic doors.

- Not close to heat generating equipment such as kitchen equipment.
- Not in an enclosed environment unless a remote indoor sensor is used.
- Hot or cold air from ducts.
- Radiant heat from sun or appliances.
- Concealed pipes and chimneys.
- Unheated (uncooled) areas such as an outside wall behind the thermostat.

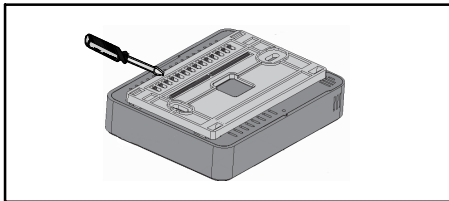
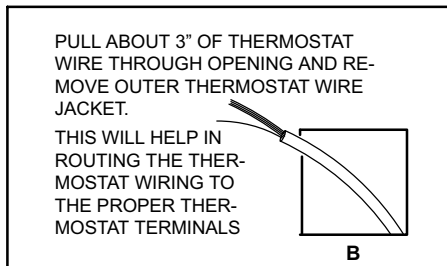
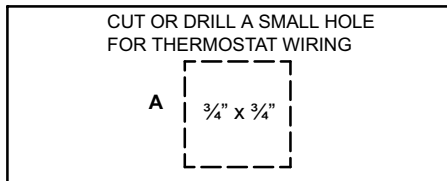
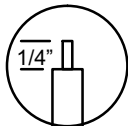

Figure 1. Removing Back Plate

4. Use steps **A** through **J** (step **J** applicable when using provided wall plate) to install the thermostat.



C TRIM 1/4" INSULATION FROM
END OF EACH WIRE



DRILL 3/16" HOLES AT MARKED LOCATIONS
ON WALL FOR WALL ANCHORS

E

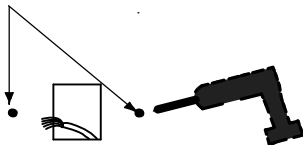

(USE A LEVEL) ALIGN WALL PLATE

D

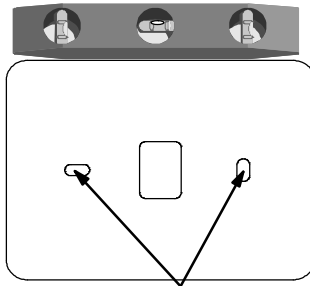

USE UNIT WALL PLATE AS TEMPLATE TO MARK
DESIRED MOUNTING HOLE LOCATIONS ON WALL

NOTE: INSTALLATION OF WALL PLATE
IS OPTIONAL.

Thermostat Installation with Wall Plate

F - Place wall plate over holes in wall.



H - Attach back plate to wall plate.

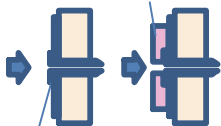

J - Attach thermostat to back plate.

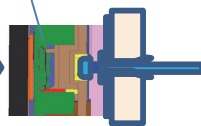

G - Insert wall anchors through wall plate into wall.

I - Insert provided screws through back and wall plates into wall anchors.

Thermostat Installation without Wall Plate

G - Place back plate over wall anchors in wall.

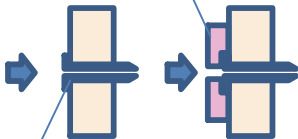

I - Attach thermostat to back plate.

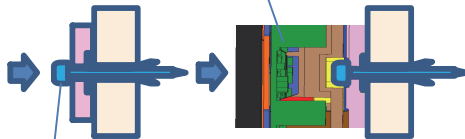

F - Insert wall anchors through wall plate into wall.

H - Insert provided screws through back plate into wall anchors.

WIRING THERMOSTAT

Below are the terminal designations and a general description of their purpose.

1. Connect wiring between thermostat, indoor and outdoor units.
2. Connect internal and external sensors if applicable. See information starting on page 11 for sensor wiring and configuring sensor settings under the Installer Settings menu.

NOTE - *Wire run should not exceed 300 feet (100m).*

3. Seal the hole in the wall with a suitable material to prevent drafts from entering the thermostat case.
4. Configure thermostat and equipment for system type, program the thermostat, and test system.

TERMINAL DESIGNATIONS

- Ti - Remote indoor temperature sensor
- Tc - Sensor common terminal
- To - Outdoor or discharge air temperature sensor
- Ec - Economizer/Time-of-Day (TOD) output-powered via R terminal.
- D - Dehumidification relay
- W2 - Second-stage heating (non-heat pump) or fourth-stage (heat pump)
- Y2 - Second-stage heating or cooling
- O - Cool active reversing valve
- B - Heat active reversing valve
- C - Common 24VAC
- G - Fan relay
- W1 - First-stage heating (non-heat pump or emergency heat) or third-stage heating (heat pump)
- Y1 - Compressor output
- R - 24VAC power

Settings

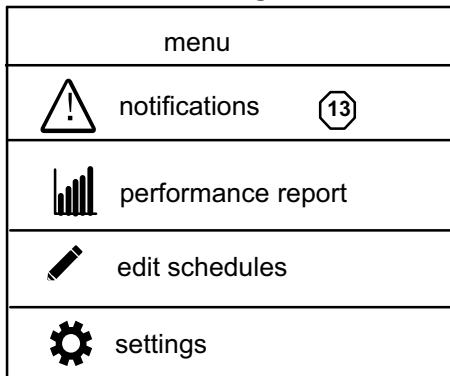
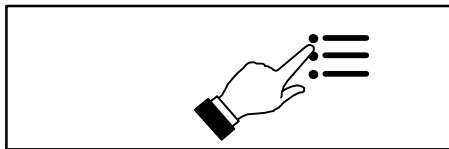

Figure 2. Menu Screen

Menu

1. Touch **menu** option from the home screen.



2. Touch and hold the **settings** option on the menu. This will display the **installer settings** notice and then the **installer settings** menu. You may be asked for an access code. The factory default access code is 864.

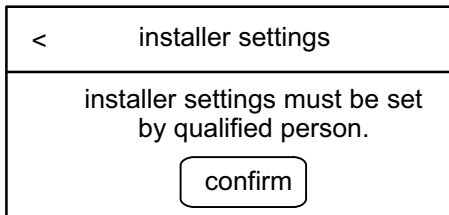

Figure 3. Installer Menu Screen Confirmation

Installer Settings

SYSTEM SETUP

Sets the thermostat for operation with either a heat pump or condenser unit and defines the number of compressor stages and the number of backup heat stages (gas, electric or both).

< system settings	
compressor settings	
non heat pump	✓
heat pump	
compressor stage	1 +
indoor unit settings	
no heat	
gas/oil	✓
electric	
indoor heat stage	1 +

Figure 4. System Setup

SENSORS SETTINGS

Use the following information to install sensors and setup in the user interface.

< Indoor Outdoor	
outdoor sensor	
outdoor	✓
discharge air	
none	
indoor sensor	
remote 10k	
remote 20k	
internal	✓

Figure 5. Sensor Selections

Outdoor Sensor (*small commercial split systems only*)

An outdoor temperature sensor (**X2658**) is required for balance points and Humiditrol® unit operations.

Users has three options to select from (under Installer Settings > sensor settings > outdoor sensor):

- Option 1 is using a outdoor temperature sensor (**X2658**) (default). Sensor connects to **To** and **Tc** terminals on the thermostat.
- Option 2 is using a discharge air temperature sensor (**19L22**). Connects to **To** and **Tc** terminals on thermostat. This sensor is a non-adjustable duct mount temperature sensor.

NOTE - *The outdoor sensors use standard non-shielded thermostat wiring; it may be wired using two wires of a multiple wire cable.*

Indoor Sensors (*remote temperature room sensor*)

This thermostat can support one to five remote indoor temperature sensors. Users have three options to select from under Installer Settings > sensor settings > indoor sensor:

- Option 1 is remote 10k (47W37)
- Option 2 is remote 20k (47W36)
- Option 3 is internal (default)

NOTE: *Both external sensors are purchase separately. Wiring examples for up to five sensors are illustrated in figure 6 on page 13. All examples shown result in Option 2, 20k setting.*

For detail installation requirements and procedure, refer to the instructions provided with either kit. Thermostat terminals **Ti** and **Tc** are used for indoor sensor(s).

NOTE - *All remote sensors use standard non-shielded thermostat wiring; outdoor sensors may be wired using two wires of a multiple wire cable.*

NOTE - *Outdoor and indoor sensor wire runs should not exceed 300 feet (100m).*

NOTE: *The discharge air sensor is for monitoring and display only. There is no control based on input from this sensor.*

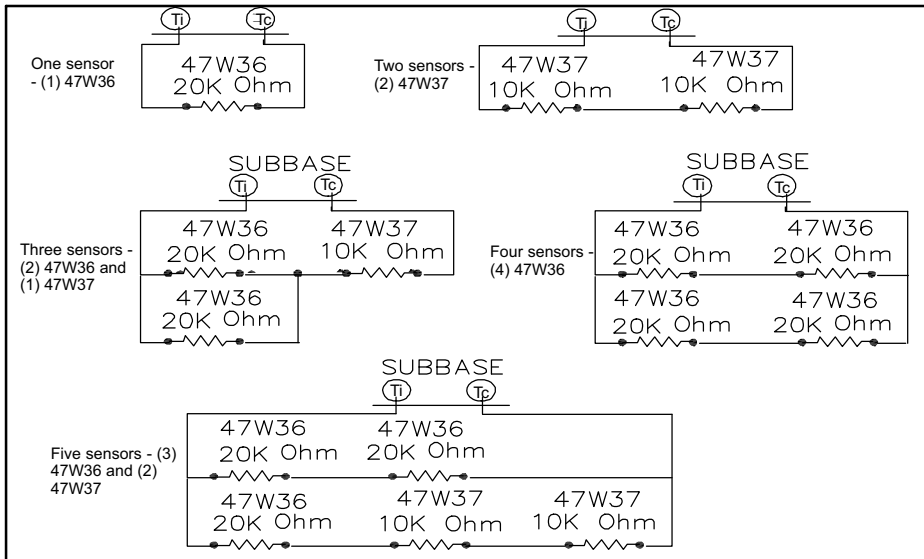

Figure 6. Indoor Sensor Configurations (Option 2, 20K Setting)

RESIDUAL COOL

Default is 0 seconds. This is the time, in seconds, that the fan runs after a call for cooling is satisfied in order to deliver any residual cooling ability from the coil and ductwork into the conditioned space. Options are 0, 30, 60, 90 and 120 seconds. Touch < to return to previous menu.

LOW AND HIGH BALANCE POINTS

These balance points are for heat pump systems only with an outdoor sensor installed and enabled plus a indoor unit setting enable. Either gas/oil or electric will enable the balance point options in the installer settings list.

1. When in heat mode and the outdoor temperature is below the programmed Low Balance Point, then heat pump heating is not allowed and only backup heat will be used.
2. When in heat mode and the outdoor temperature is above the programmed High Balance Point, then heat pump heating is allowed and backup heat will not be used.
3. When in heat mode and the outdoor temperature is between the programmed Low and High Balance Points, then heat pump heating and backup heat can be used.
4. Options are enable or disable. Default for both is disable. Once enabled, the following settings are available.
5. Low Balance Point Default is 25°F. Adjustable range is -40°F to 48°F.
6. High Balance Point Default is 50°F. Adjustable range is -38°F to 75°F.

NOTE - *The high balance point minimum range is adjustable to within +2°F of the low balance point setting. For example, if the low balance point is set to 0°F, then the lowest setting for the high balance point is 2°F.*

DEADBAND

Default is 2°F. The deadband setting is the minimum difference between the cooling and heating set points. This setting is used in cool/heat mode to ensure smooth equipment operation. The deadband is adjustable from 2 to 9°F. Use the + or - option to select desired deadband. Touch < to return to previous menu.

SMOOTH SET RECOVERY(SSR)

Options are enable or disable. Default is Enabled.

When enabled, smooth set recovery begins recovery up to two hours before the programmed time so that the programmed temperature is reached at the corresponding programmed event time. Assume 12°F per hour for first stage gas/electric heating and 6°F per hour for first stage compressor based heating or cooling. With Smooth Set Recovery disabled, the control will start a recovery at the programmed time.

NOTE - Smooth Set Recovery and SSR STG 2 Lock Out operations vary depending on equipment (see table 1).

SSR STAGE 2 LOCK OUT

Default is 20 minutes. Use the + or - option to set the number of minutes before the programmed event time that stage 2 is allowed to operate (20 to 120 minutes in 10 minute increments). Touch < to return to previous menu.

CONTRACTOR INFORMATION

This allows the installer to add contractor name, address, phone, email, website and number.

Touch < to return to previous menu.

TEMPERATURE OFFSET

Default is 0°F. This setting can be used to offset the displayed space temperature by up to +/- 5°F. This offset also applies to the control temperature. Touch < to return to previous menu.

HUMIDITY OFFSET

Default is 0%. This can be used to offset the displayed and controlled space relative humidity (RH) by up to +/- 10% RH. Touch < to return to previous menu.

Table 1. Smooth Set Recovery (SSR) & SSR Stage 2 Lock Out Operation

Equipment Available	When SSR is enabled then SSR Stage 2 lock out is enabled. Can be set between 20 and 120 minutes. Default is 20 minutes	When SSR is disabled then SSR Stg 2 lock-out setting is disabled.
Single-stage heat pump with one or two stages of electric backup	<ul style="list-style-type: none"> • Run heat pump (Y1) only • All backup heat (W1/W2) is enabled and SSR Stage 2 Lock Out is set between 20 - 120 minutes before the wake-up set point. 	Run heat pump (Y1) and will have available backup heat (W1/W2) as needed.
Two-stage heat pump with one- or two-stages of electric backup	<ul style="list-style-type: none"> • Run heat pump (Y1/Y2) only. • All backup heat (W1/W2) is enabled and SSR Stage 2 Lock Out is set between 20 - 120 minutes before the wake-up set point. 	Run heat pump (Y1/Y2) and will have available backup heat (W1/W2) as needed.
Single-stage heat pump with single-stage gas or oil backup	<ul style="list-style-type: none"> • Run heat pump (Y1) only • All backup heat (W1) is enabled and SSR Stage 2 Lock Out is set between 20 - 120 minutes before the wake-up set point. 	<ul style="list-style-type: none"> • Run heat pump (Y1) until a second-stage heating demand is needed which is determined by the time / temperature differential. • Heat pump operation will stop and gas or oil heat will start. • Changeover and lock-in to W1 heat will occur until set point reached.

Equipment Available	When SSR is enabled then SSR Stg 2 lock out is automatically enabled.	When SSR is disabled then SSR Stg 2 lock-out setting is disabled.
<p>Single-stage heat pump with:</p> <ul style="list-style-type: none"> • Two-stages of gas or oil backup • Modulation furnace 	<ul style="list-style-type: none"> • Run heat pump (Y1) only • All backup heat (W1/W2) is enabled and SSR Stage 2 Lock Out is set between 20 - 120 minutes before the wake-up set point. 	<ul style="list-style-type: none"> • Run heat pump (Y1) until a second-stage heating demand is needed which is determined by the time / temperature differential. • Heat pump operation will stop and changeover to W1/W2 heat as needed • Lock-in W1/W2 heat until set point is reached.
<p>Two-stage heat pump with one stage gas/oil backup</p>	<ul style="list-style-type: none"> • Run heat pump (Y1/Y2) only. • All backup heat (W1/W2) is enabled and SSR Stage 2 Lock Out is set between 20 - 120 minutes before the wake-up set point. 	<ul style="list-style-type: none"> • Run heat pump (Y1/Y2) until a second-stage demand is needed which is determined by the time / temperature differential. • Heat pump operation will stop and gas or oil heat will start. • Changeover and lock-in to W1 heat will occur until set point is reached

Equipment Available	When SSR is enabled then SSR Stg 2 lock out is automatically enabled.	When SSR is disabled then SSR Stg 2 lock-out setting is disabled.
<p>Two-stage heat pump with:</p> <ul style="list-style-type: none"> • Two-stages of gas or oil backup • Modulation furnace 	<ul style="list-style-type: none"> • Run heat pump (Y1/Y2). • All backup heat (W1/W2) is enabled and SSR Stage 2 Lock Out is set between 20 - 120 minutes before the wake-up set point. 	<ul style="list-style-type: none"> • Run HP (Y1/Y2) until a second-stage demand is needed which is determined by the time / temperature differential. • Heat pump operation will stop and changeover and lock-in to W1/W2 heat until set point is reached.
<p>Two stages of gas/oil heat or modulation furnace</p>	<p>Run W1 only; W2 is enabled and SSR Stage 2 Lock Out is set between 20 - 120 minutes before the wake-up set point.</p>	<p>Run W1 heat and bring on W2 heat until set point is reached.</p>
<p>Single stage cooling</p>	<p>Run Y1 to wake up set point.</p>	<p>Run Y1 heat until set point is reached.</p>
<p>Single stage cooling</p>	<p>Run Y1 during recovery and enable Y2 field wake up set point.</p>	<p>Run Y1 and Y2 heat as needed until set point is reached.</p>

STAGE DELAY TIMER

Default ON. When ON, all stage delay timers (stages 2, 3, and 4) are enabled and will serve to bring on additional stage(s) of cooling or heating on a timed basis (default 20 minutes) in cases when the previous stage of heating or cooling will not raise or lower the room temperature to the set point in a given time.

When OFF is selected all stage delay timers are disabled. This means stages are changed based on the temperature and not their timer delays. Scroll to STG DELAY TIMERS; and touch to select the applicable stage delay timer. Touch < to return to previous menu.

STAGE DELAY DIFFERENTIALS

Stage delays and differentials are individual set in the installer settings screen.

STAGE 1 DIFF

Stage 1 differential is used in all thermostats. The default is 1.0°F but can be programmed between 0.5° and 8.0°F in 0.5°F increments. Touch < to return to previous menu.

STAGE 2 THROUGH 4 DIFF

(Where applicable) The default is 1.0°F but can be programmed between 0.5° and 8.0°F in 0.5°F increments. Touch < to return to previous menu.

STAGE 2 THROUGH 4 DELAYS

(Where applicable) If STG DELAY TIMERS is turned ON, the default delay is 20 minutes but can be programmed from 5 to 120 minutes in 5-minute increments. If first stage fails to advance the ambient temperature toward the setpoint by 1.0°F in the programmed delay time, then the second stage is activated.

Scroll to STG 2 DELAY (or 3 or 4); touch to select. Select the desired delay. Touch < to return to previous menu.

H/C STAGES LOCKED IN

When disabled the heat/cool stages are turned off separately). When enabled (default), heat/cool stages are turned off together. Touch < to return to previous menu.

STAGE 2 HP LOCK TEMP

When disabled the heat pump stage 2 operates normally). Enable this setting in dual fuel applications to lock in the 2nd stage compressor when the outdoor temperature is at or less than the

LOCK TEMP set point. Scroll to STAGE 2 HP LOCK TEMP; touch ENTER. Use - + option to select a LOCK TEMP between -40 and 75°F. Touch < to return to previous menu.

Configuration	Figures
Multi-stage Cooling for Heat Pump/Non-Heat Pump	7
Heating - Non-Heat Pump (1 or 2 stages)	8
Heating - Heat Pump with NO backup heat	10
Heating - Heat Pump w/electric heat (2-stage: 1compr/1backup)	10
Heating - Heat Pump w/electric heat (3 stage: 2compr/1backup)	11
Heating - Heat Pump w/electric heat (3 stage: 1compr/2backup)	11
Heating - Heat Pump w/electric heat (4 stage: 2compr/2backup)	12
Heating - dual fuel (2-stage: 1compr/1backup)	13
Heating - dual fuel (3 stage: 1compr/2backup)	14
Heating - dual fuel (3 stage: 2compr/1backup)	15
Heating - dual fuel (4 stage: 2compr/2backup)	16

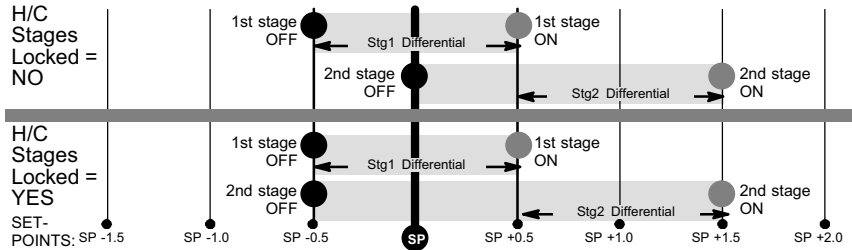

Figure 7. Cooling - 1 or 2 Stages

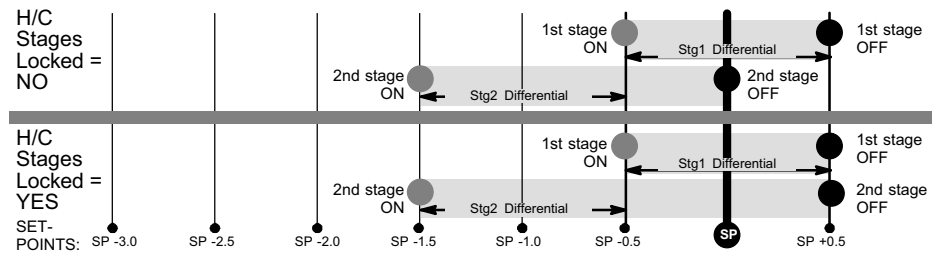

Figure 8. Heating - Non-Heat Pump or Heat Pump w/o Backup Heat - 1 or 2 stages

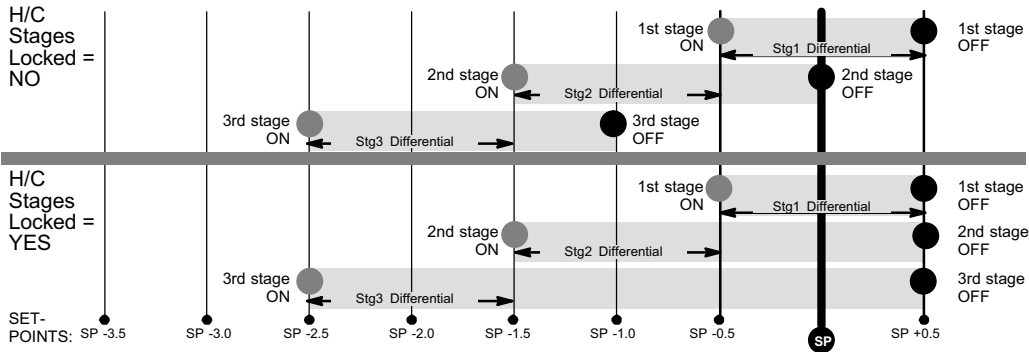

Figure 9. Heating - Heat Pump w/Electric - 3 Stage (2 compressor / 1 backup OR 1 compressor / 2 backup)

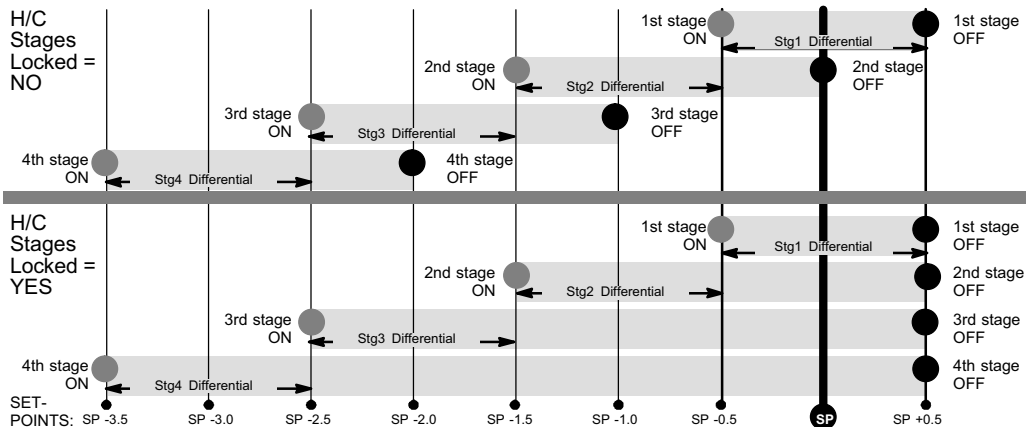

Figure 10. Heating - Heat Pump w/Electric - 4 Stage (2 compressor / 2 backup)

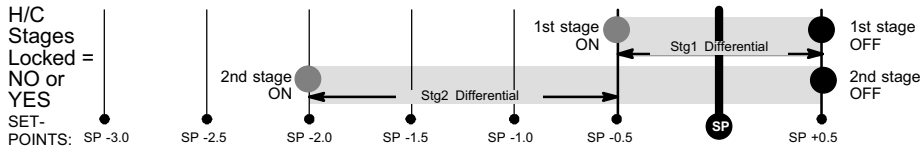

Figure 11. Heating - Dual Fuel - 2 Stage (1 compressor / 1 backup)

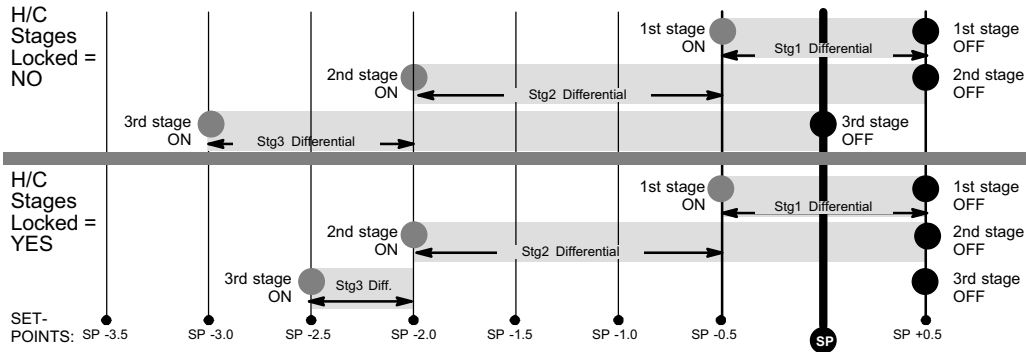

Figure 12. Heating - Dual Fuel - 3 Stage (1 compressor / 2 backup)

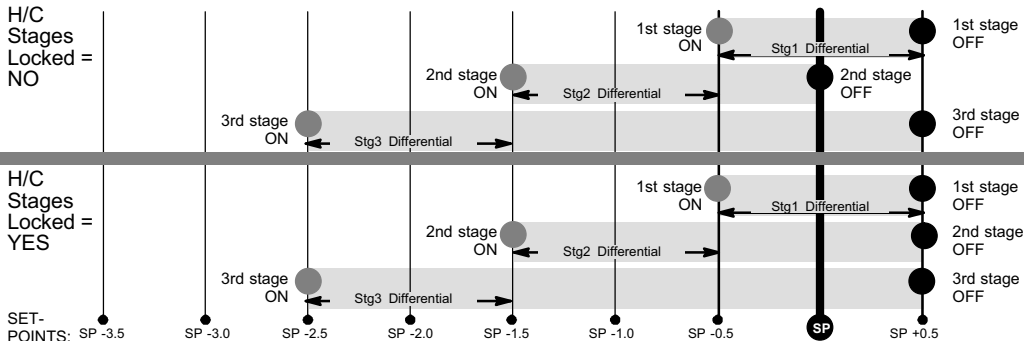

Figure 13. Heating - Dual Fuel - 3 Stage (2 compressor / 1 backup)

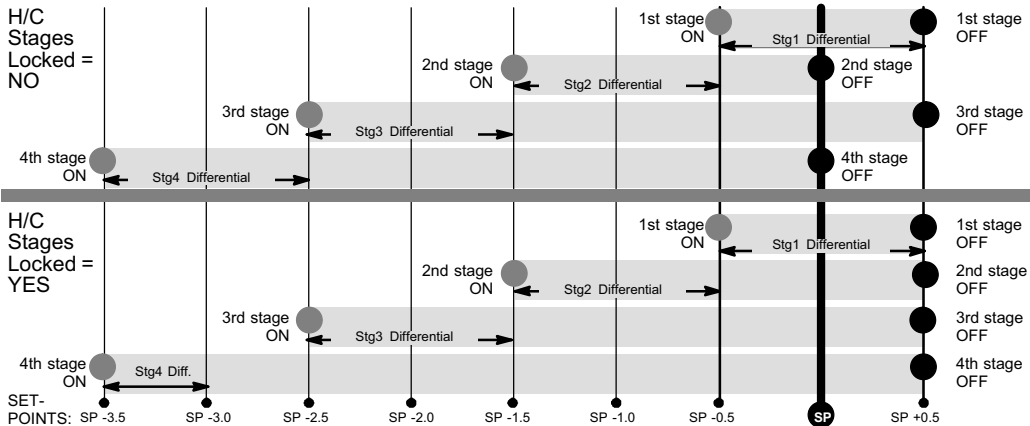

Figure 14. Heating - Dual Fuel - 4 Stage (2 compressor / 2 backup)

COMPRESSOR PROTECT

Default is ON and it can be turned OFF, however only for one compressor cycle and then it will revert back to ON.

If the system is running in compressor protection, the home screen will display "WAITING" only if there is a compressor cooling or heating call (Y1/Y2).

If compressor protection is running and there is a demand for electric heating, the system waits for the compressor protection timer to expire.

HUMIDITY SETTING

See page 29 for dehumidify mode.

CUSTOM REMINDERS

Two custom reminders may be rename on this screen to the desired name (name is limited to 19 characters). After entering the new name, touch the done key to return to the customer reminder screen.

To set a reminder go to the User Settings screen and select **reminders**. The reminder setting screen will appear and a list all of the predefined reminders plus the two custom reminders will appear at the end of the list.

Scroll to CUSTOM REMINDER 1 or 2 (or renamed titles). Touch the title to select the reminder. By default all reminders are set to disabled. Touch disable to choose from 3mon, 6mon, 12mon, 24mon or custom date.

When finished, touch < to return to previous menu.

RESET SETTING

To reset the thermostat to factory defaults, scroll to RESET SETTINGS and touch to select. Read the message and to continue touch **CONFIRM**.



IMPORTANT

RESET SETTINGS erases all programming and returns the thermostat to the factory conditions, including the installer settings. Use this only as a last resort.

Table 2. Energy Saving Set Points

	Time	Heating	Cooling	Fan Setting
^a The thermostat default setting is two period only. To use four periods, change the appropriate setup parameter.	Occ1	70°F (21°C)	76°F (24°C)	Auto
	Unocc1	55°F (10°C)	85°F (29.5°C)	Auto
	Occ2 ^a	70°F (21°C)	76°F (24°C)	Auto
	Unocc2 ^a	62°F (17°C)	85°F (29.5°C)	Auto

ENERGY SAVING DEFAULT

Energy saving recommended set points for heating and cooling can help save energy. The time and temperatures reference in table 2 are pre-programmed into the thermostat to achieve energy savings.

Scroll to ENERGY SAVING DEFAULT; touch to select. Read the message on the screen and to continue, touch **CONFIRM**.

SYSTEM TEST MODE

After the thermostat has been installed and set-up, the installer may run a system test function (accessed through the installer settings menu), to test all cooling, heating, Emergency Heating stages and FAN outputs. Tests are available for Y1, Y2, W1, W2, G, ECO and D. The test can be activate by toggling the action to **ON**. The OB test can be toggle between B and O.

Touching the **OFF** button next to the desired option will change the status to **ON** and will enable the relay for that terminal. Touching again will turn **OFF** the relay. Touch the left arrow (<) to exit the system test mode.



NOTICE

Risk of equipment damage.

Can cause compressor failure.

In dual fuel system applications, do not turn on heat pump and furnace at the same time in system test mode.

All HVAC components can be tested to confirm the signals between thermostat and unit are being sent and were received.

NOTES: After 5 minutes without a test being initiated, the test modes is disabled and system goes back to the normal mode (i.e. HOME screen).

When in SYSTEM TEST MODE, the compressor minimum off timer is bypassed.

Dehumidify Mode

Dehumidification (removing moisture from air) can only occur when the thermostat is in **cooling mode**.

Dehumidify Mode Setting	Terminal D State
Normal, Max or Humiditrol	De-energized for dehumidification and energized for all other modes.
	De-energizing D terminal is used to reduce the speed of the indoor blower during dehumidification. At the same time the Y1 and Y2 (if available) terminals become energized (24VAC).
RTU / Aux Dehumidifier	Energized for de-humidification.
	Dehumidification adjustment will change the relative humidity (RH) setting between 45 to 60% RH (default setting is 50% RH). The lower the number, the more humidity will be removed from the air.

A selection option under **Installer settings > Humidity settings > Dehumidify > Dehumidify mode** must be enabled before the user will have control over the humidity. The mode selected determines how the user can adjust the relative humidity (RH). The installer settings include:

1. **NORMAL**
2. **MAX**
3. **RTU/AUX DEHUMIDIFIER**
4. **HUMIDITROL**
5. **OFF**

NORMAL

In this mode, dehumidification occurs if these conditions are met and signals are present at specific terminals:

1. Dehumidification has been enabled on installer settings, and
2. Unit is in COOL mode
3. Dehumidification demand exists (RH above set point)
4. Cooling demand exists (Y1 energized).

MAX

In this mode, dehumidification occurs if all maximum conditions are true, except cooling demand may or may not be present. Maximum over cool from cooling set point is 2°F.

RTU/AUX DEHUMIDIFIER

When dehumidify mode is in "RTU/AUX dehumidifier", "D" terminal works in active logic.

The RTU/Aux dehumidifier setting is used with RTU with rooftop units only when a dehumidifier is used for dehumidification. This requires:

1. Dehumidifier has been wired to thermostat per dehumidifier installation instructions.
2. Dehumidification has been enabled on installer settings.
3. Unit is in COOL mode, (or if in AUTO, there has been at least one thermostat cooling call made prior to the dehumidification demand).
4. Dehumidification demand exists (RH above set point).

HUMIDITROL®

This setting is for commercial split systems only. If Humiditrol is enabled in the installer settings, then this adjustment affects overcooling operation. Overcooling ranges from 2°F below the cooling setpoint (**MIN** setting) down to 2°F above the heating setpoint (**MAX** setting). Halfway between the two settings is the **MID** setting.

If a Humiditrol® EDA is installed and enabled, then the thermostat must be configured to properly operate the Humiditrol® EDA as follows (see Figure 15 for the Humiditrol® EDA operation flowchart):

Check the HUMIDITY SETTINGS in user settings to confirm that the user has turned **ON** dehumidification setting.

NOTE - Humiditrol® EDA operation requires use of an outdoor sensor. If sensor is not connected and Humiditrol® EDA is enabled, "OUTDOOR SENSOR REQUIRED" is displayed in the information display.

Cooling only—Dehumidification will only occur if:

1. Dehumidification demand is present,
2. Cooling demand is not present,
3. Outdoor temperature is less than 95°F,
4. Indoor temperature is not cooler than 65°F or cooler than the heating set point + 2°F (**IF** the difference between cooling and heating set points is greater than the deadband).

In this case, 24VAC is removed from the **D** terminal and **Y1** and **Y2** terminal (if available) becomes activated with 24VAC. This cycles the indoor variable speed motor to the dehumidification speed and cycle **Y2 ON** to the outdoor unit. Cooling has priority over Humiditrol® calls. Humiditrol® mode is allowed to over cool up to 2°F above the heating set point.

Heat only—Thermostat will cycle heating **ON** and **OFF** to maintain heating set point. Dehumidification functions are disabled.

Heat/Cool—*Dehumidification will only occur if a dehumidification demand is present, a cooling demand is not present, outdoor temperature is less than 95°F, indoor temperature is above 65°F and the indoor temperature is not cooler than 2°F above heating set point.*

Note: If the last thermostat demand was a heating demand, the thermostat does not require a cooling demand before Humiditrol® operation.

Humidity Sensor Fault

If the humidity sensor fault occurs, the thermostat shuts off dehumidification.

Other Humiditrol® EDA Notes

If the outdoor sensor is disconnected while HUMIDITROL is enabled, the thermostat will not allow operation in dehumidification mode.

Set point range: 45 to 60% Relative Humidity (RH). Factory default - 50%.

Relative Humidity controls to within 3% on either side of RH set point.

When dehumidify mode is in NORMAL or MAX or, HUMIDITROL, "D" terminal works in reverse logic.

NORMAL, MAX and HUMIDITROL modes are disabled by default from the factory.

As a precaution, regardless of how low the heating set point has been set, Humiditrol® dehumidification is inhibited below 65°F indoor temperature.

Economizer

Economizer control means that for every period in the day that the unit is in occupied mode, the occupancy out **Ec** (relay output) shall be energized whenever there is a demand for fan (**G** is active). The thermostat does not directly control the damper position. The output from the thermostat will be wired to an economizer controller or a unit controller which will control the position of the damper.

Table 3. Terminal Ec Operation

Effective Occupancy	Call for Cooling	Terminal EC State
Occupied	-	Energized
Unoccupied	Yes	De-Energized
	No	De-Energized
Override	-	Energized

Unit Part (Catalog) & Serial Numbers

A label on the back of the thermostat is visible through an opening in the back of base plate. This identifies the Lennox Catalog Number, Part Number and Serial Number. Separate the base plate from the thermostat to see additional manufacturing information.

Memory Protection

The thermostat stores all the information concerning its programming (state, mode, program information, last temperature measured) in a nonvolatile memory.

This function avoids the loss of the state of the thermostat when a power-down occurs. The only thing that might be lost is the clock and date information, however, a super capacitor will remember clock / date information for as long as it has a charge (approximately 24 hours). When power down occurs (due to a power outage) the thermostat is able to shut off heat relays (Y1, Y2, W1, W2) when in heating mode and W1 and W2 when in cooling mode. The **O** and **B** relay will maintain their last state. When power is restored the thermostat will be in heat /cool mode so either mode can run to re-satisfy the temperature setting. Day and time (schedules) may be off due to battery loss

Appendix A. Flow Diagrams

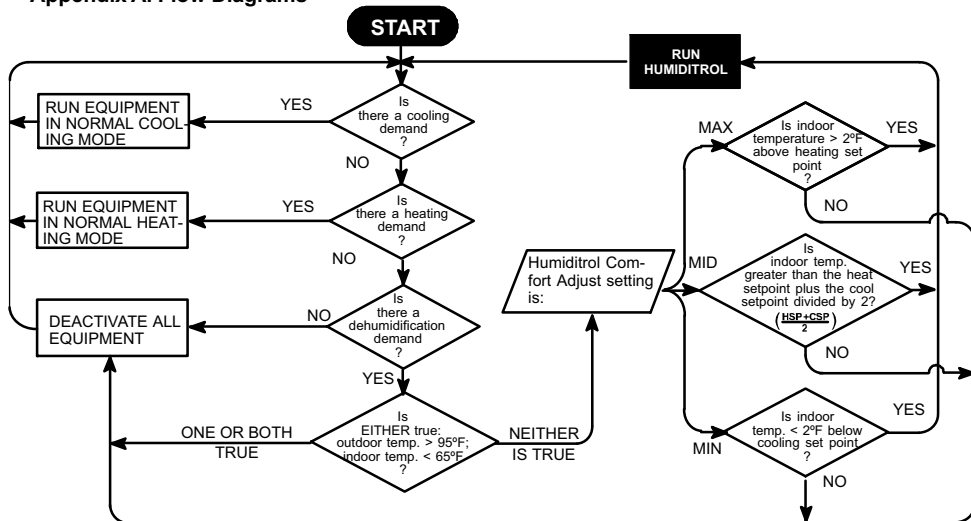

Figure 15. Thermostat Operation with Humiditrol® EDA Enabled

Appendix B. Diagnostic Information

Error Code	Screen Text	Priority 0:high 1:middle 2:low	Message Type	Condition	System Action	Action to Clear / Recovery Condition
4	high temperature protection	0	critical	High temperature protection when outdoor ambient temperature exceeds 96°F (35.6°C)	All stages of heat are turned off by safety relay. This error is displayed on notification screen.	Once temperature drops below 96°F (35.6°C), the system resume operation.
5	temperature sensor error	0	critical	Local temperature sensor is out of range -40°F to 158°F There is a finite difference between main thermostat and sub-thermostat which is greater than 5°F.	Indoor temp is displayed as "-" on the home screen. This will STOP all temperature related operation. All stages of heat are turned off by safety relay. This error is displayed on notification screen.	Either thermostat will have to be replaced or if the sensor returns to normal operating range, the error message will automatically clear and the system will resume operation.
7	memory error	0	critical	EEPROM error (Power ON)	System will restore using to Energy Star defaults and resume operations. This error is displayed on notification screen.	Thermostat will need to be replaced.
8	memory error	0	critical	EEPROM error (Operating)	System will operate in normal mode operation until power off. This error is displayed in notification screen.	

Error Code	Screen Text	Priority 0:high 1:middle 2:low	Message Type	Condition	System Action	Action to Clear / Recovery Condition
9	no external sensor	1	critical	The outdoor temperature sensor is out of range (-50°F to 180°F)	<p>For Outdoor Temperature Sensor: No Humiditrol or Humidity operation.</p> <p>D terminal stays activated and other operation will continue to operate.</p> <p>Thermostat will stop the system operation if input from requires outdoor temperature information when any of these conditions, i.e. balance point control and 2nd stage lock in are applicable.. System will default to mode of operation that does not required input from the outdoor temperature sensor.</p> <p>The temperature display on the home screen will be disabled. If user turns on the display from user settings and error will be displayed again.</p> <p>This error is displayed in notification screen.</p>	Replace outdoor temperature sensor.

Error Code	Screen Text	Priority 0:high 1:middle 2:low	Message Type	Condition	System Action	Action to Clear / Recovery Condition
10	humidity sensor error	1	critical	With humidifier or dehumidifier) and conditions are as follows: 0%: Stat will detect error 0-5%: Stat may detect error 5-95%: Normal operation 95-99%: Thermostat may detect error 100%: Thermostat will detect error	All humidity operation will stop and the reading for humidity will not be valid. This message indicates hum sensor is not working correctly. The display of Indoor Humidity on HOME screen will be "--". This error is displayed in notification screen.	Either thermostat will have to be replaced or if the sensor returns to normal operating range, the error message will automatically clear and the system will resume operation.
11	humidity sensor error	1	critical	Without humidifier or dehumidifier and the sensor reads out of range 0% to 100%.	The reading for humidity will not be valid. This message indicates hum sensor is not working correctly. The display of Indoor Humidity on HOME screen will be "--". This error is displayed in notification screen.	

Appendix C. Reminder Information

Error Code	Screen Text	Message Type	Action to Clear / Recovery Condition
12	replace media filter	reminder	Touch either done to clear the reminder or remind later button.
13	replace UV lamp		
14	replace humidity pad		
15	routine system check-up		
16	replace metal insert for pure air		
17	user editable		
18	user editable		

Appendix D. Supported Configurations

This thermostat support air conditioner and heat pump systems with one or two speed compressors. It also supports dual-fuel and Humiditrol accessory. For all possible configuration see table below.

	Backup/ Indoor Heat	Comp. stages	Back- up/In- door Heat Stages	Heat Stages	1st Heat Stage	2nd Heat Stage	3rd Heat Stage	4th Heat Stage	1st Em Heat Stage	2nd Em heat Stage	Cool Stages	1st Cool Stage	2nd Cool Stage
HP	GAS/OIL	1	1	2	Y1	W1			W1		1	Y1	
HP	GAS/OIL	1	2	3	Y1	W1	W1+W2		W1	W1+W2	1	Y1	
HP	NONE	1	0	1	Y1						1	Y1	
HP	GAS/OIL	2	1	3	Y1	Y1+Y2	W1		W1		2	Y1	Y1+Y2
HP	GAS/OIL	2	2	4	Y1	Y1+Y2	W1	W1+W2	W1	W1+W2	2	Y1	Y1+Y2
HP	NONE	2	0	2	Y1	Y1+Y2					2	Y1	Y1+Y2
HP	ELEC.	1	1	2	Y1	Y1+W1			W1		1	Y1	
HP	ELEC.	1	2	3	Y1	Y1+W1	Y1+W1+W2		W1	W1+W2	1	Y1	
HP	NONE	1	0	1	Y1						1	Y1	
HP	ELEC.	2	1	3	Y1	Y1+Y2	Y1+Y2+W1		W1		2	Y1	Y1+Y2
HP	ELEC.	2	2	4	Y1	Y1+Y2	Y1+Y2+W1	Y1+Y2+W1+W2	W1	W1+W2	2	Y1	Y1+Y2
HP	NONE	2	0	2	Y1	Y1+Y2					2	Y1	Y1+Y2
Non HP	GAS/OIL OR ELEC.	1	1	1	W1						1	Y1	

	Backup/ Indoor Heat	Comp. stages	Back- up/In- door Heat Stages	Heat Stages	1st Heat Stage	2nd Heat Stage	3rd Heat Stage	4th Heat Stage	1st Em Heat Stage	2nd Em heat Stage	Cool Stages	1st Cool Stage	2nd Cool Stage
Non HP	GAS/OIL OR ELEC.	1	2	2	W1	W1+W2						1	Y1
Non HP	NONE	1	0									1	Y1
Non HP	GAS/OIL OR ELEC.	2	1	1	W1							2	Y1 Y1+Y2
Non HP	GAS/OIL OR ELEC.	2	2	2	W1	W1+W2						2	Y1 Y1+Y2
Non HP	NONE	2	0									2	Y1 Y1+Y2

Appendix E. Installation Checklist

Item Number	Item	Yes	No
1	Is the thermostat level where mounted on the wall?		
2	Is the thermostat installed in a controlled space when using dehumidification control with remote sensor?		
3	Is the thermostat installed away from direct sunlight or discharge air vents?		
4	Has the thermostat been wired correctly based on the type of equipment installed (air handler, outdoor unit and accessories)?		
5	Is the thermostat wiring secured tightly to the terminals?		
6	Is the common wire (terminal C) connected?		
7	Has the System Test Mode located under the installer settings been used to verify proper operation?		

INDEX

A

Access Code, 10

B

Balance Points, Low, High, 14

C

Code, 10

Compressor Protection, 27

Compressor Short Cycle Protection, 3

Configurations, 20

Configurations Supported, 39

Contractor Information, 15

Custom Reminders, 27

D

Deadband, 15

Dehumidify, 29

Humiditrol, 31

Max, 30

Normal, 30

RTU/Aux Dehumidifier, 30

Diagnostic Information, 35

Dimensions, 3

E

Economizer, 32

Energy Saving Default Settings, 28

F

Features, 3

H

H/C Stages Locked In, 19

Humidification Sensor Fault, 32

Humidity Offset, 15

Humidity Setting, 27

I

Installation Checklist, 41

Installer Access Code, 10

Installer code, 10

Installer Settings, 11

M

Memory Protection, 33

O

Outdoor Temperature Sensor, 12

R

Reminder Information, 38

Remote Indoor Temperature Sensors, 12

Reset Settings, 27

Residual Cool, 14

S

Screws, 2

Sensors Setup, 11

Serial Numbers, 33

Smooth Set Back Recovery (SSR), 15

Smooth Set Back Stage 2 Lock Out, 15

Stage 1 Differential, 19

Stage 2 HP Lock Temp, 20

Stage 2 through 4 Delays, 19

Stage 2 through 4 Differential, 19

Stage Delay Differentials, 19

Stage Delay Timer, 19

System Setup, 11

System Test Modes, 28

T

Temperature Offset, 15

Thermostat Installation, 5

U

Unit Part (Catalog) & Serial Numbers, 33

W

Wall Anchors, 2