



©2015 Lennox Industries Inc.  
Dallas, Texas, USA



So simple. So smart. So comfortable.

### RETAIN THESE INSTRUCTIONS FOR FUTURE REFERENCE

#### General

This XP20 outdoor heat pump is designed for use with HFC-410A refrigerant only. This unit must be installed with an approved indoor air handler or coil. See the Lennox XP20 Product Specifications bulletin (EHB) for approved indoor component match-ups.

These instructions are intended as a general guide and do not supersede local codes in any way. Consult authorities having jurisdiction before installation.

**IMPORTANT:** BEFORE APPLYING ANY POWER (MAIN OR LOW VOLTAGE) TO THE OUTDOOR UNIT, THE FIELD MUST CONFIRM iComfort Wi-Fi® THERMOSTAT HAS VERSION 2.1 OR HIGHER SOFTWARE. (REFER TO iComfort Wi-Fi® THERMOSTAT MANUAL.)

THIS UNIT IS A INTEGRAL COMPONENT OF A SYSTEM THAT WILL REQUIRE AN iComfort Wi-Fi® THERMOSTAT AND iComfort®-enabled AIR HANDLER OR FURNACE.



# INSTALLATION INSTRUCTIONS

## Elite® Series XP20 Units

HEAT PUMP  
507508-01  
6/2015

### PACKING LIST



OUTDOOR UNIT



WARRANTY CERTIFICATE



RAST 6-PIN CONNECTOR (1)

### NOTICE !

For more in-depth information, consult the Installation and Service Procedures manual, available as Corp. 1408-L10 on DaveNet or through the Technical Support department at 800-453-6669.

### WARNING

Improper installation, adjustment, alteration, service or maintenance can cause property damage, personal injury or loss of life.

Installation and service must be performed by a licensed professional installer (or equivalent) or service agency.

### STEP 1 -- SETTING THE UNIT -- Clearances

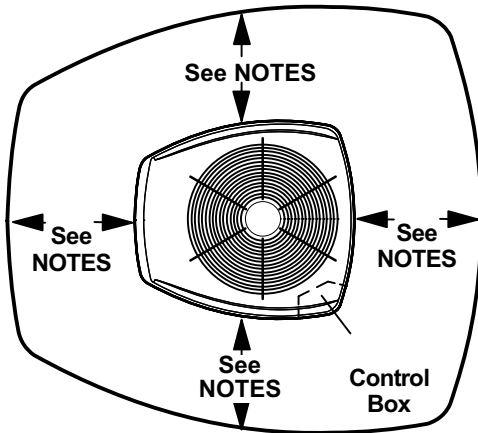

#### NOTES:

Service clearance of 30 in. must be maintained on one of the sides adjacent to the control box.

Clearance to one of the other three sides must be 36 in.

Clearance to one of the remaining two sides may be 12 in. and the final side may be 6 in.

A clearance of 24 in. must be maintained between two units.

48 in. clearance required on top of unit.

**NOTICE:** Specific applications may require adjustment of the listed installation clearances to provide protection for the unit from physical damage or to avoid conditions which limit operating efficiency. (Example: Clearances may have to be increased to prevent snow or ice from falling on the top of the unit. Additional clearances may also be required to prevent air recirculation when the unit is installed under a deck or in another tight space.)

FIGURE 1



0615

507508-01

## STEP 1 -- SETTING THE UNIT (Continued) -- Dimensions / Placement

### UNIT DIMENSIONS - INCHES (MM)

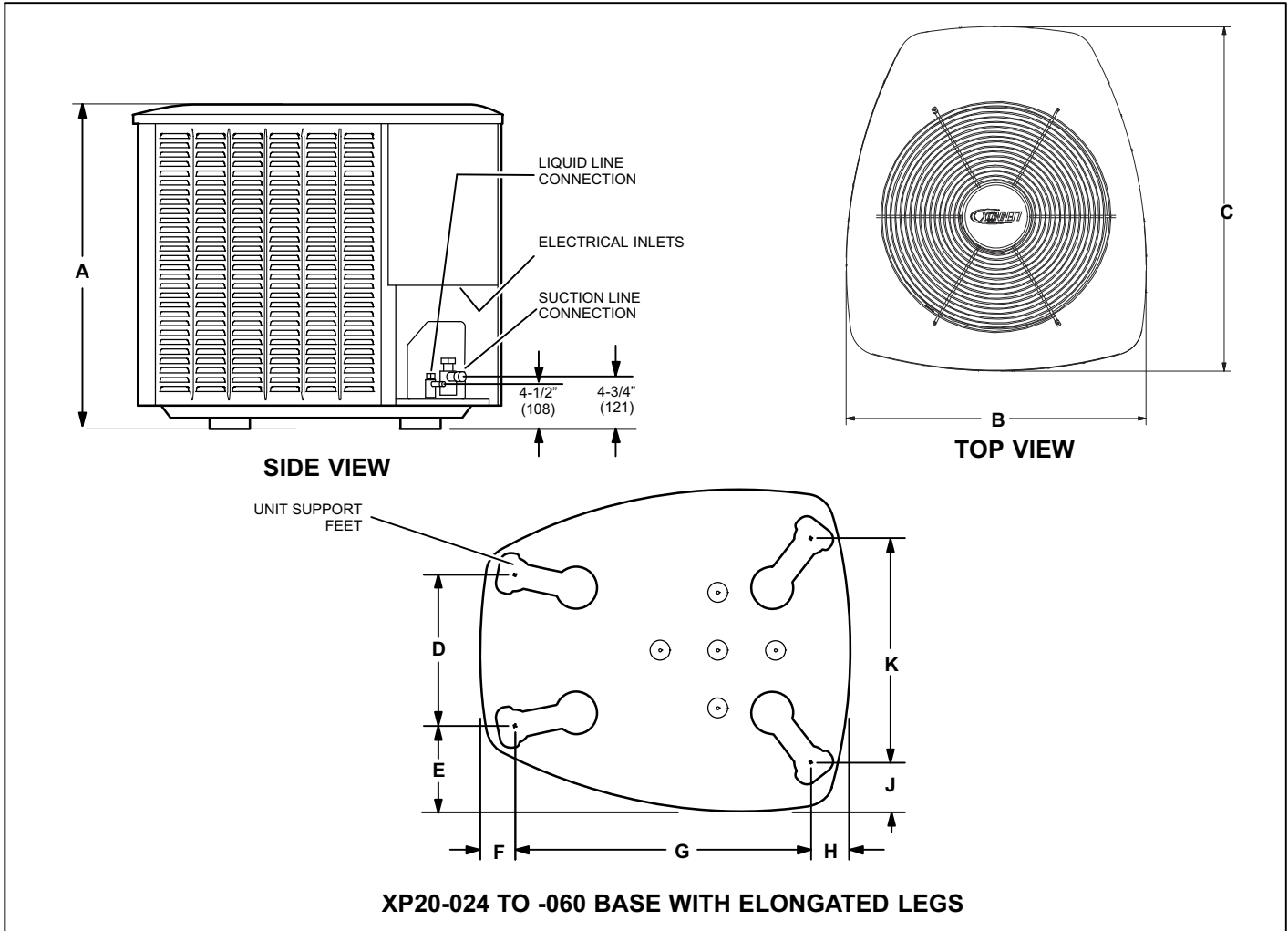

Model Number	A	B	C	D	E	F	G	H	J	K
XP20-024-230	39 (991)	35-1/2 (902)	39-3/8 (1001)	16-7/8 (429)	8-3/4 (222)	3-1/8 (79)	30-3/4 (781)	4-5/8 (117)	3-3/4 (95)	26-7/8 (683)
XP20-036-230										
XP20-048-230	45 (1143)	35-1/2 (902)	39-3/8 (1001)	16-7/8 (429)	8-3/4 (222)	3-1/8 (79)	30-3/4 (781)	4-5/8 (117)	3-3/4 (95)	26-7/8 (683)
XP20-060-230										

### **⚠ WARNING**

To prevent personal injury, as well as damage to panels, unit or structure, observe the following:

While installing or servicing this unit, carefully stow all removed panels so that the panels will not cause injury to personnel, objects or nearby structures. Also, take care to store panels where they will not be subject to damage (e.g., being bent or scratched).

While handling or stowing the panels, consider any weather conditions (especially wind) that may cause panels to be blown around and damaged.

### **⚠ CAUTION**

As with any mechanical equipment, contact with sharp sheet metal edges can result in personal injury. Take care while handling this equipment and wear gloves and protective clothing.

### **⚠ CAUTION**

Before attempting to perform any service or maintenance, turn the electrical power to unit OFF at disconnect switch.

## NOTICE !

### Roof Damage!

This system contains both refrigerant and oil. Some rubber roofing material may absorb oil, causing the rubber to degrade. Failure to follow this notice could result in damage to roof surface.

## IMPORTANT !

Exhaust vents from dryers, water heaters and furnaces should be directed away from the outdoor unit. Prolonged exposure to exhaust gases and the chemicals contained within them may cause condensation to form on the steel cabinet and other metal components of the outdoor unit. This will diminish unit performance and longevity.

## PLACEMENT

Install unit away from windows.

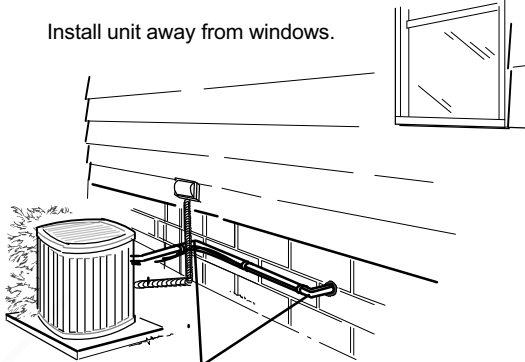

TWO 90° ELBOWS INSTALLED IN LINE SET WILL REDUCE LINE SET VIBRATION.

FIGURE 2

INSTALL UNIT LEVEL OR, IF ON A SLOPE, MAINTAIN SLOPE TOLERANCE OF 2 DEGREES (OR 2 INCHES PER 5 FEET [50 MM PER 1.5 M]) AWAY FROM BUILDING STRUCTURE.

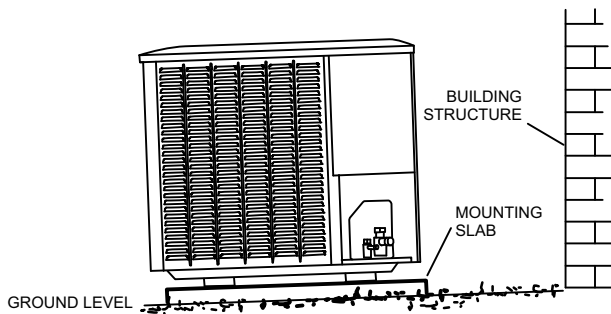
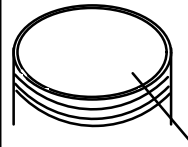
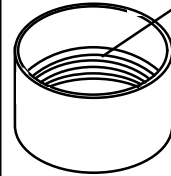

FIGURE 3

## ELEVATED SLAB MOUNTING USING FEET EXTENDERS



2" (50.8MM) SCH 40 MALE THREADED ADAPTER



2" (50.8MM) SCH 40 FEMALE THREADED ADAPTER

LEG DETAIL

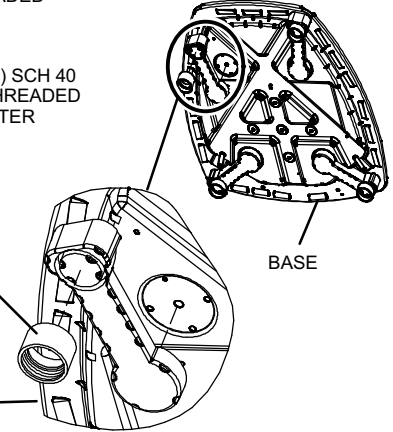

Use additional 2" SCH 40 male threaded adapters which can be threaded into the female threaded adapters to make additional adjustments to the level of the unit.

FIGURE 4

## STABILIZING UNIT ON UNEVEN SURFACES

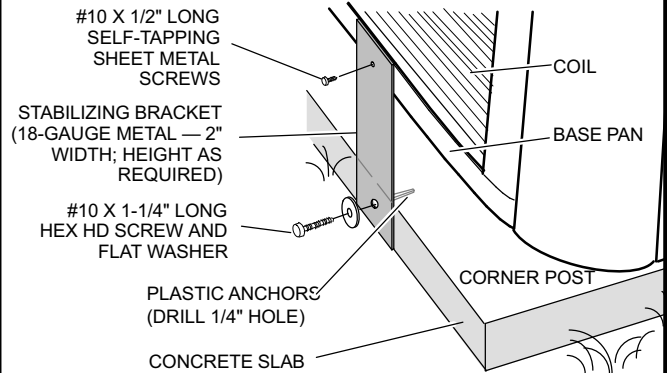

## IMPORTANT !

### Unit Stabilizer Bracket Use (field-provided):

Always use stabilizers when unit is raised above the factory height. (Elevated units could become unstable in gusty wind conditions.)

Stabilizers may be used on any unit installed on unstable and uneven surfaces.

FIGURE 5

## STEP 2 – REFRIGERANT PIPING – Flushing Existing Line Set & Indoor Coil

Flush the existing line set per industry standards. For more information, refer to the XP20 Installation and Service Procedures manual available on DaveNet. **CAUTION - DO NOT** attempt to flush and re-use existing line sets or indoor coil when the system contains contaminants (i.e., compressor burn out).

### **WARNING**

Refrigerant can be harmful if it is inhaled. Refrigerant must be used and recovered responsibly. Failure to follow this warning may result in personal injury or death.

### **WARNING**

Polyol ester (POE) oils used with HFC-410A refrigerant absorb moisture very quickly. It is very important that the refrigerant system be kept closed as much as possible. **DO NOT** remove line set caps or service valve stub caps until you are ready to make connections.

### **IMPORTANT !**

If this unit is being matched with an approved line set or indoor unit coil that was previously charged with mineral oil, or if it is being matched with a coil which was manufactured before January of 1999, the coil and line set must be flushed prior to installation. Take care to empty all existing traps. Polyol ester (POE) oils are used in Lennox units charged with HFC-410A refrigerant. Residual mineral oil can act as an insulator, preventing proper heat transfer. It can also clog the expansion device and reduce system performance and capacity.

Failure to properly flush the system per the XP20 Installation and Service Procedures will void the warranty.

### **WARNING**



When using a high-pressure gas such as nitrogen to pressurize a refrigeration or air conditioning system, use a regulator that can control the pressure down to 1 or 2 psig (6.9 to 13.8 kPa).

### **WARNING**



Fire, Explosion and Personal Safety Hazard. Failure to follow this warning could result in damage, personal injury or death.

Never use oxygen to pressurize or purge refrigeration lines. Oxygen, when exposed to a spark or open flame, can cause fire and/or an explosion, that could result in property damage, personal injury or death.

### **IMPORTANT !**

Some scroll compressors have an internal vacuum protector that will unload scrolls when suction pressure goes below 20 psig. A hissing sound will be heard when the compressor is running unloaded. Protector will reset when low pressure in system is raised above 40 psig. **DO NOT REPLACE COMPRESSOR.**

### **IMPORTANT !**

If unit is equipped with a crankcase heater, and outdoor ambient temperature is below 60°F, unit should be energized 24 hours before start-up to prevent compressor damage as a result of slugging.

The XP20 is a variable capacity heat pump system utilizing variable speed compressor technology. With the variable speed compressor and variable pumping capacity, additional consideration must be given to refrigerant piping sizing and application. The guidelines below are to be used exclusively for the XP20 systems.

#### HEAT PUMP SYSTEM (HFC-410A)

- Total equivalent length equals 180 feet (piping and all fittings included).

**NOTE** — Length is general guide. Lengths may be more or less, depending on remaining system design factors.

- Maximum linear (actual) length = 150 feet.
- Maximum linear liquid lift = 60 feet.

**NOTE** — Maximum lifts are dependent on total length, number of elbows, etc. that contribute to total pressure drop.

- Maximum length vapor riser equals 60 feet.
- **Up to 50 Linear Feet:** Use rated line sizes listed in table 1.
- **Between 51 and 150 Linear Feet:** Crankcase heater and non-bleed port TXV factory installed. No additional components required. Vertical vapor riser must be sized to the vapor riser listed in the table 2 on systems with line sets longer than 51 feet. Use tables 2 and 3 to determine the correct liquid and vapor line sizes.
- **Over 150 Linear Feet:** not recommended.
- Additional oil is not required for systems with line lengths up to 150 feet.

#### SUCTION TRAPS

For systems with the outdoor unit 5 - 60 feet above the indoor unit, one trap must be installed at the bottom of the suction riser.

**Table 1. Standard Refrigerant Line Set — Up to 50 Linear Feet in Length**

Inches (mm)					
Model Number (-xx*)	Valve Size Connections		Recommended Line Sets		
Model Number (-xx*)	Liquid Line	Suction Line	L15 Line Set Model	Line Set Length	Catalog Number
XP20-024-230-XX	3/8" (10 mm)	3/4" (19 mm)	L15-41-30	30 feet (9.1 m)	89J60
XP20-036-230-XX XP20-048-230-XX	3/8" (10 mm)	7/8" (22 mm)	L15-65-40	40 feet (12.2 m)	89J61
			L15-65-50	50 feet (15.2 m)	89J62
XP20-060-230-XX	3/8" (10 mm)	1-1/8" (29 mm) **	Field-fabricated		

\* Applicable to all minor revision numbers unless otherwise specified.  
 \*\* Some applications may require a field-provided 1-1/8" to 7/8" adapter.

**Table 2. XP20 Line Set Guidelines — 51 to 150 Linear Feet in Length**

Model	Maximum Total Equivalent Length (ft)	Maximum Linear (actual) Length (ft)	Maximum Vapor Riser (ft)	Maximum Linear Liquid Lift (ft)	Preferred Vapor Line Sizes for Horizontal Runs	Required Vapor Riser Size
-024	180	150	60	60	7/8"	5/8"
-036	180	150	60	60	7/8"	3/4"
-048	180	150	60	60	7/8"	7/8"
-060	180	150	60	60	7/8"	7/8"

**Table 3. Liquid Line Diameter Selection Table**

Unit	Line Size	Total Linear Length (feet)						Max. Elevation (ft)
		25	50	75	100	125	150	
-024	5/16"	25	50	55	48	40	33	
	3/8"	25	50	60	60	60	60	
-036	3/8"	25	50	60	56	51	45	
	1/2"	25	50	60	60	60	60	
-048	3/8"	25	50	50	41	31	22	
	1/2"	25	50	60	60	60	60	
-060	3/8"	25	50	36	22	8	NR	
	1/2"	25	50	60	60	60	59	

**NOTE** - Shaded rows indicate rated liquid line size

- Find your unit on the left side of the table.
- Start with the rated liquid line size (shaded row) on the outdoor unit
- Select the actual Total Linear Length of your system shown at the top of the table.
- The elevation listed in the table is the maximum allowed for the liquid line listed.
- Select or consider the larger liquid line size shown in the table if the elevation does not meet your requirements.

**NOTE** - For new or replacement line set installation, refer to Service and Application Note - Corp. 9112-L4 (C-91-4).

## STEP 2 -- REFRIGERANT PIPING -- Removing Existing Indoor Metering Device

### 1A TYPICAL EXISTING FIXED ORIFICE REMOVAL PROCEDURE (UNCASED COIL SHOWN)

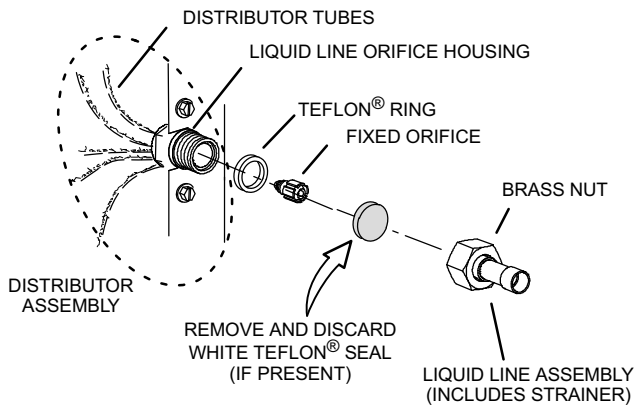

- F. On fully cased coils, remove the coil access and plumbing panels.
- G. Remove any shipping clamps from the liquid line and distributor assembly.
- H. Using two wrenches, disconnect liquid line from liquid line orifice housing. Take care not to twist or damage distributor tubes during this process.
- I. Remove and discard fixed orifice, valve stem assembly (if present) and Teflon® washer as illustrated above.
- J. Use a field-provided fitting to temporarily reconnect the liquid line to the indoor unit's liquid line orifice housing.

### OR 1B TYPICAL EXISTING EXPANSION VALVE REMOVAL PROCEDURE (UNCASED COIL SHOWN)

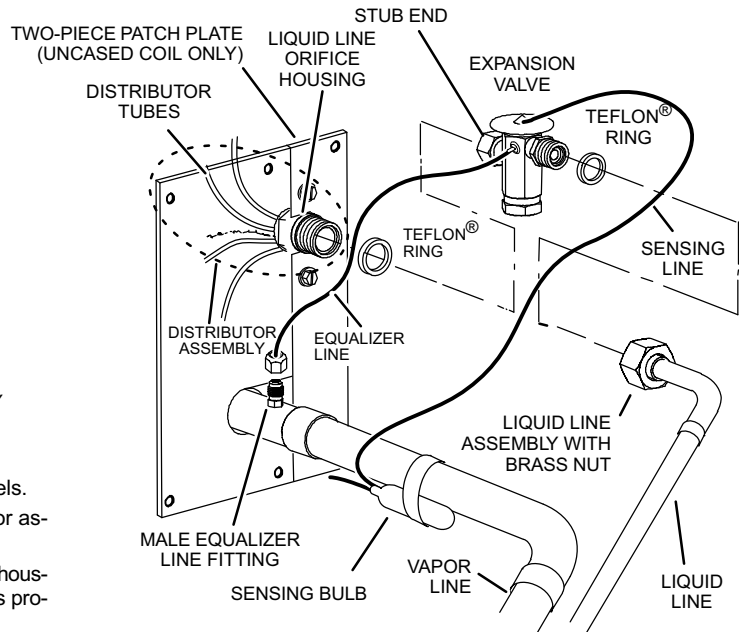

- A. On fully cased coils, remove the coil access and plumbing panels.
- B. Remove any shipping clamps from the liquid line and distributor assembly.
- C. Disconnect the equalizer line from the expansion valve equalizer line fitting on the vapor line.
- D. Remove the vapor line sensing bulb.
- E. Disconnect the liquid line from the expansion valve at the liquid line assembly.
- F. Disconnect the expansion valve from the liquid line orifice housing. Take care not to twist or damage distributor tubes during this process.
- G. Remove and discard expansion valve and the two Teflon® rings.
- H. Use a field-provided fitting to temporarily reconnect the liquid line to the indoor unit's liquid line orifice housing.

### 2 CONNECT GAUGES AND EQUIPMENT FOR FLUSHING PROCEDURE

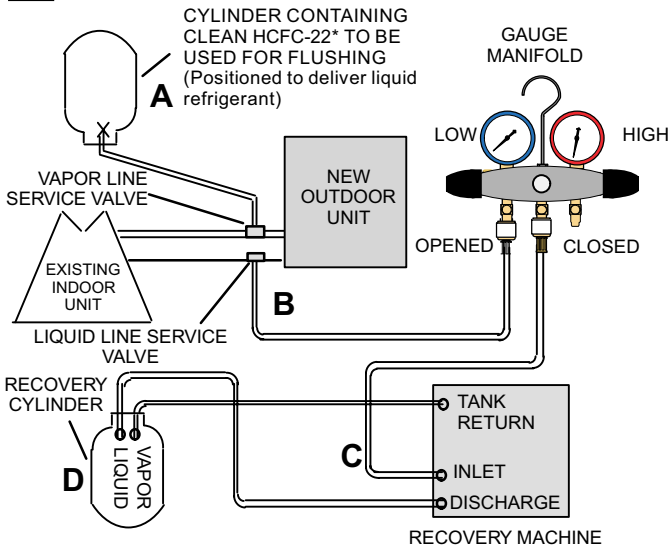

- A. HCFC-22 cylinder with clean refrigerant\* (positioned to deliver liquid refrigerant) to the vapor service valve.
- B. HCFC-22 gauge set (low side) to the liquid line valve.
- C. HCFC-22 gauge set center port to inlet on the recovery machine with an empty recovery tank connected to the gauge set.
- D. Connect recovery tank to recovery machine per machine instructions.

### 3 FLUSHING LINE SET

The line set and indoor unit coil must be flushed with at least the same amount of clean refrigerant\* that previously charged the system. Check the charge in the flushing cylinder before proceeding.

- A. Set the recovery machine for liquid recovery and start the recovery machine. Open the gauge set valves to allow the recovery machine to pull a vacuum on the existing system line set and indoor unit coil.
- B. Position the cylinder of clean HCFC-22\* for delivery of liquid refrigerant and open its valve to allow liquid refrigerant to flow into the system through the vapor line valve. Allow the refrigerant to pass from the cylinder and through the line set and the indoor unit coil before it enters the recovery machine.
- C. After all of the liquid refrigerant has been recovered, switch the recovery machine to vapor recovery so that all of the HCFC-22 vapor is recovered. Allow the recovery machine to pull the system down to 0.
- D. Close the valve on the inverted HCFC-22 drum and the gauge set valves. Pump the remaining refrigerant out of the recovery machine and turn the machine off.

**\*IMPORTANT - Clean refrigerant is any refrigerant in a system that has not had compressor burn out. If the system has experienced burn out, it is recommended that the existing line set and indoor coil be replaced.**

FIGURE 6

## STEP 2 -- REFRIGERANT PIPING -- Brazing Procedures

### 1 CUT AND DEBUR

Cut ends of the refrigerant lines square (free from nicks or dents) and debur the ends. The pipe must remain round. Do not crimp end of the line.

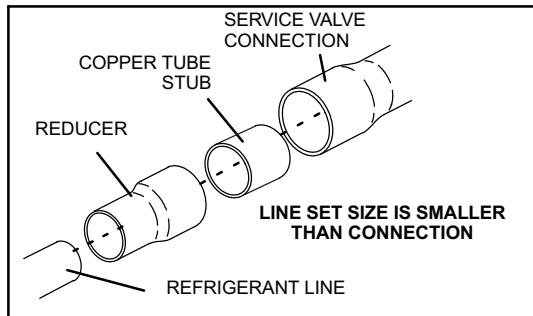
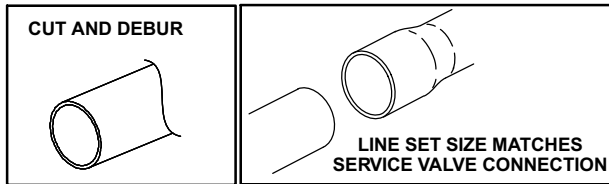

### 2 CAP AND CORE REMOVAL

Remove service cap and core from both the suction and liquid line service ports.

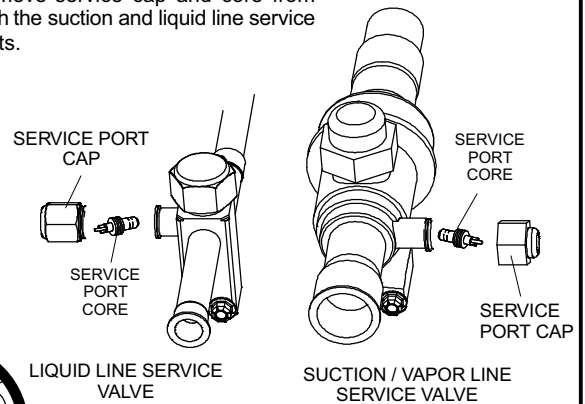

DO NOT CRIMP SERVICE VALVE CONNECTOR WHEN PIPE IS SMALLER THAN CONNECTION

### 3 ATTACH THE MANIFOLD GAUGE SET FOR BRAZING LIQUID AND SUCTION LINE SERVICE VALVES

Flow regulated nitrogen (at 1 to 2 psig) through the low-side refrigeration gauge set into the liquid line service port valve, and out of the suction line service port valve.

- Connect gauge set low pressure side to liquid line service valve (service port).
- Connect gauge set center port to bottle of nitrogen with regulator.
- Remove core from valve in suction line service port to allow nitrogen to escape.

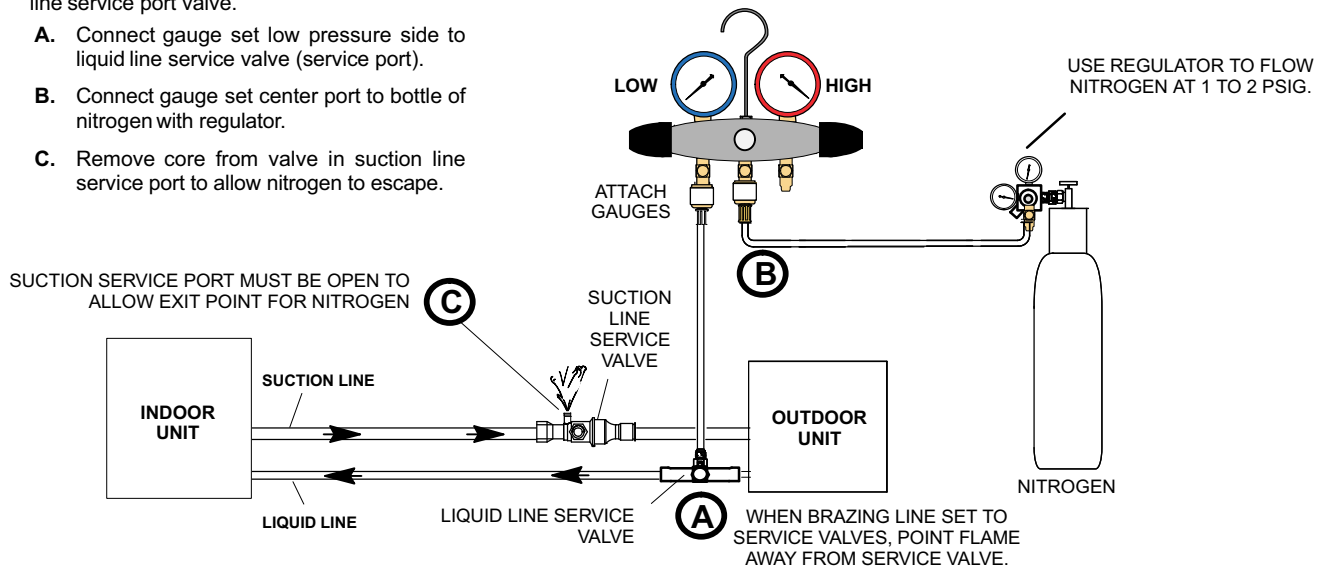

FIGURE 7

### ⚠ CAUTION

Brazing alloys and flux contain materials which are hazardous to your health.

Avoid breathing vapors or fumes from brazing operations. Perform operations only in well-ventilated areas.

Wear gloves and protective goggles or face shield to protect against burns.

Wash hands with soap and water after handling brazing alloys and flux.

### ⚠ WARNING



Danger of fire. Bleeding the refrigerant charge from only the high side may result in pressurization of the low side shell and suction tubing. Application of a brazing torch to a pressurized system may result in ignition of the refrigerant and oil mixture. Check the high and low pressures before applying heat.

## STEP 2 -- REFRIGERANT PIPING -- Brazing Procedures (Continued)

### 4 WRAP SERVICE VALVES

To help protect service valve seals during brazing, wrap water-saturated cloths around service valve bodies and copper tube stubs. Use additional water-saturated cloths underneath the valve body to protect the base paint.

### 5 FLOW NITROGEN

Flow regulated nitrogen (at 1 to 2 psig) through the refrigeration gauge set into the valve stem port connection on the liquid service valve and out of the suction / vapor valve stem port. See steps **3A**, **3B** and **3C** on manifold gauge set connections.

### 6 BRAZE LINE SET

Wrap both service valves with water-saturated cloths as illustrated here and as mentioned in step 4, before brazing to line set. Cloths must remain water-saturated throughout the brazing and cool-down process.

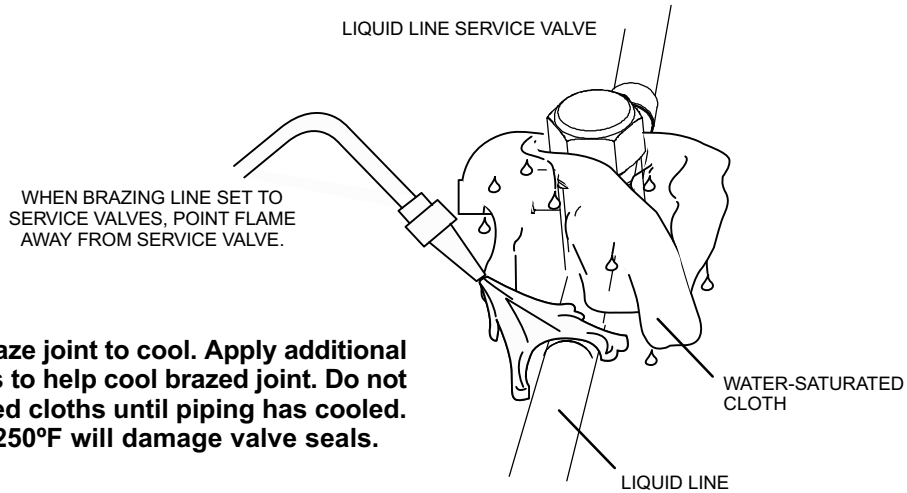

**IMPORTANT - Allow braze joint to cool. Apply additional water-saturated cloths to help cool brazed joint. Do not remove water-saturated cloths until piping has cooled. Temperatures above 250°F will damage valve seals.**

#### WARNING

**FIRE, PERSONAL INJURY, OR PROPERTY DAMAGE** may result if you do not wrap a water-saturated cloth around both liquid and suction line service valve bodies and copper tube stub while brazing the line set! The braze, when complete, must be quenched with water to absorb any residual heat.

Do not open service valves until refrigerant lines and indoor coil have been leak-tested and evacuated. Refer to Installation and Service Procedures manual found on DAVENET.

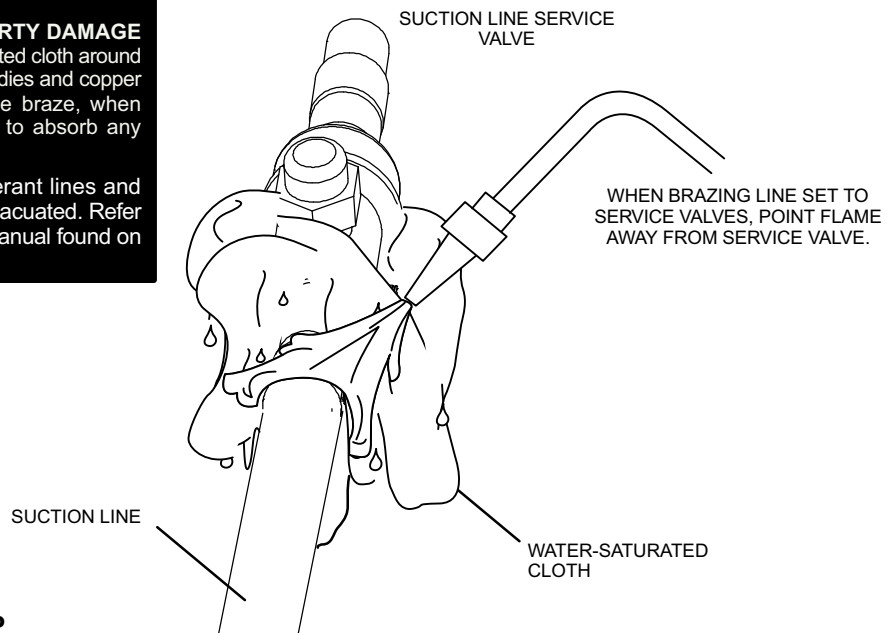

### 7 PREPARATION FOR NEXT STEP

Disconnect manifold gauge set from service ports after all connections have been brazed. Apply additional water-saturated cloths to both service valves to cool piping. Once piping is cool, remove all water-saturated cloths.

FIGURE 8



### STEP 3 -- INSTALLING INDOOR CHECK / EXPANSION VALVE

This outdoor unit is designed for use in systems that include an expansion valve metering device. See the *XP20 Product Specifications bulletin (EHB)* for approved expansion valve kit match-ups and application information. The expansion valve can be installed internal or external to the indoor coil. In applications where an uncased coil is being installed in a field-provided plenum, install the expansion valve in a manner that provides access for future field service of the expansion valve. Refer to following illustration for reference during installation of expansion valve.

#### INDOOR EXPANSION VALVE INSTALLATION

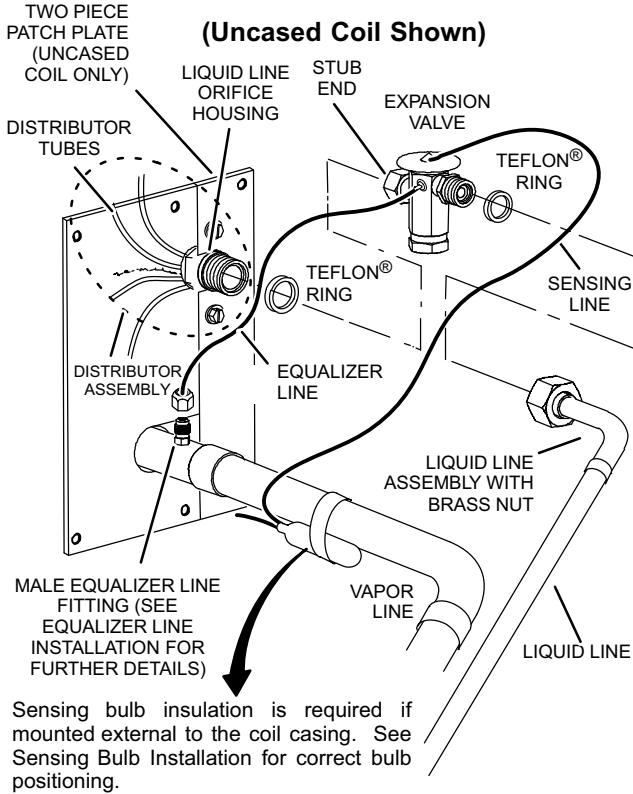

- C. Install one of the provided Teflon® rings around the stubbed end of the expansion valve and lightly lubricate the connector threads and expose surface of the Teflon® ring with refrigerant oil.
- D. Attach the stubbed end of the expansion valve to the liquid line orifice housing. Finger tighten and use an appropriately sized wrench to turn an additional 1/2 turn clockwise as illustrated in the figure above, or tighten to 20 ft-lb.
- E. Place the remaining Teflon® washer around the other end of the expansion valve. Lightly lubricate connector threads and expose surface of the Teflon® ring with refrigerant oil.
- F. Attach the liquid line assembly to the expansion valve. Finger tighten and use an appropriately sized wrench to turn an additional 1/2 turn clockwise as illustrated in the figure above or tighten to 20 ft-lb.

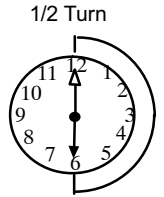

#### SENSING BULB INSTALLATION

- A. Attach the vapor line sensing bulb in the proper orientation (illustrated below) using the clamp and screws provided.  
*NOTE - Confirm proper thermal contact between vapor line and expansion valve sensing bulb before insulating the sensing bulb once installed.*
- B. Connect the equalizer line from the expansion valve to the equalizer vapor port on the vapor line. Finger tighten the flare nut plus 1/8 turn (7 ft-lbs) as illustrated below left.

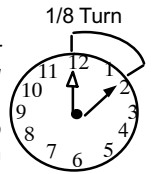

#### EQUALIZER LINE INSTALLATION

- A. Remove and discard either the flare seal cap or flare nut with copper flare seal bonnet from the equalizer line port on the vapor line as illustrated below.
- B. Remove the field-provided fitting that temporarily reconnected the liquid line to the indoor unit's distributor assembly.

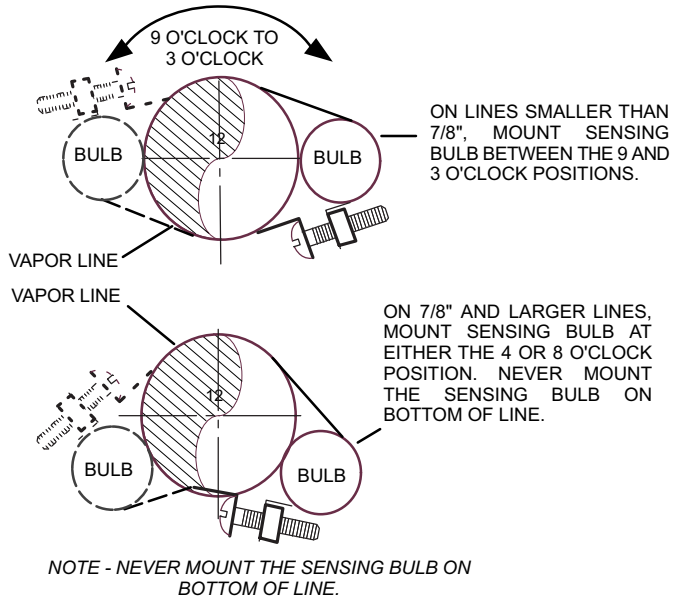
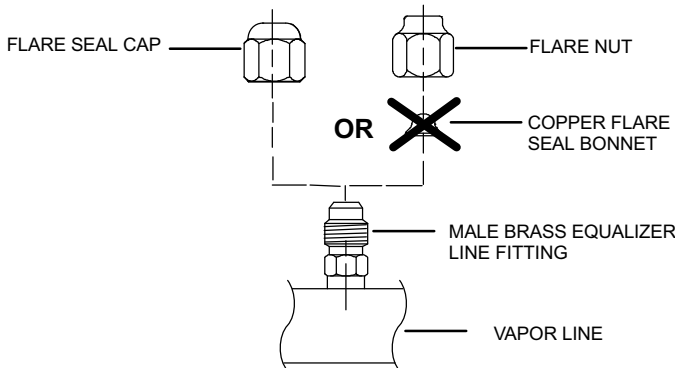
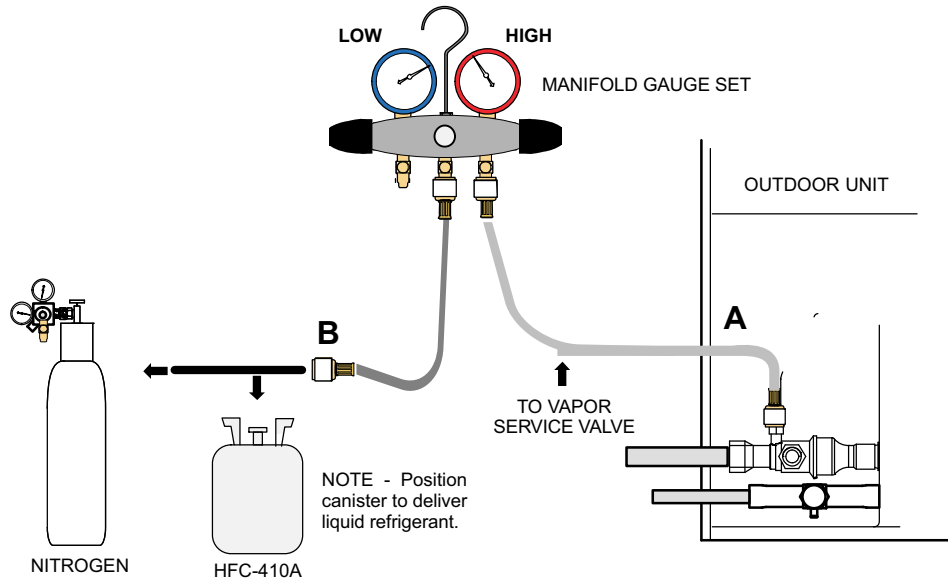

FIGURE 9

## STEP 4 -- LEAK TEST AND EVACUATION



# 1

### CONNECT GAUGE SET

**A.** Connect the high-pressure hose of an HFC-410A manifold gauge set to the vapor valve service port.  
**NOTE** - Normally, the high-pressure hose is connected to the liquid line port. However, connecting it to the vapor port better protects the manifold gauge set from high-pressure damage.

**B.** With both manifold valves closed, connect the cylinder of HFC-410A refrigerant to the center port of the manifold gauge set.

**NOTE** - Later in the procedure, the HFC-410A container will be replaced by the nitrogen container.

# 2

### TEST FOR LEAKS

After the line set has been connected to the indoor and outdoor units, check the line set connections and indoor unit for leaks. Use the following procedure to test for leaks:

- With both manifold valves closed, connect the cylinder of HFC-410A refrigerant to the center port of the manifold gauge set. Open the valve on the HFC-410A cylinder (vapor only).
- Open the high-pressure side of the manifold to allow HFC-410A into the line set and indoor unit. Weigh in a trace amount of HFC-410A. [A trace amount is a maximum of two ounces (57 g) refrigerant or three pounds (31 kPa) pressure.] Close the valve on the HFC-410A cylinder and the valve on the high-pressure side of the manifold gauge set. Disconnect the HFC-410A cylinder.
- Connect a cylinder of nitrogen with a pressure regulating valve to the center port of the manifold gauge set.
- Adjust nitrogen pressure to 150 psig (1034 kPa). Open the valve on the high side of the manifold gauge set in order to pressurize the line set and the indoor unit.
- After a few minutes, open one of the service valve ports and verify that the refrigerant added to the system earlier is measurable with a leak detector.
- After leak testing, disconnect gauges from service ports.

FIGURE 10

## STEP 4 -- LEAK TEST AND EVACUATION (Continued)

### 3 CONNECT GAUGE SET

**NOTE** - Remove cores from service valves (if not already done).

- Connect low side of manifold gauge set with 1/4 SAE in-line tee to *vapor* line service valve
- Connect high side of manifold gauge set to *liquid* line service valve
- Connect available micron gauge connector on the 1/4 SAE in-line tee.
- Connect the vacuum pump (with vacuum gauge) to the center port of the manifold gauge set. The center port line is used later for both the HFC-410A and nitrogen containers.

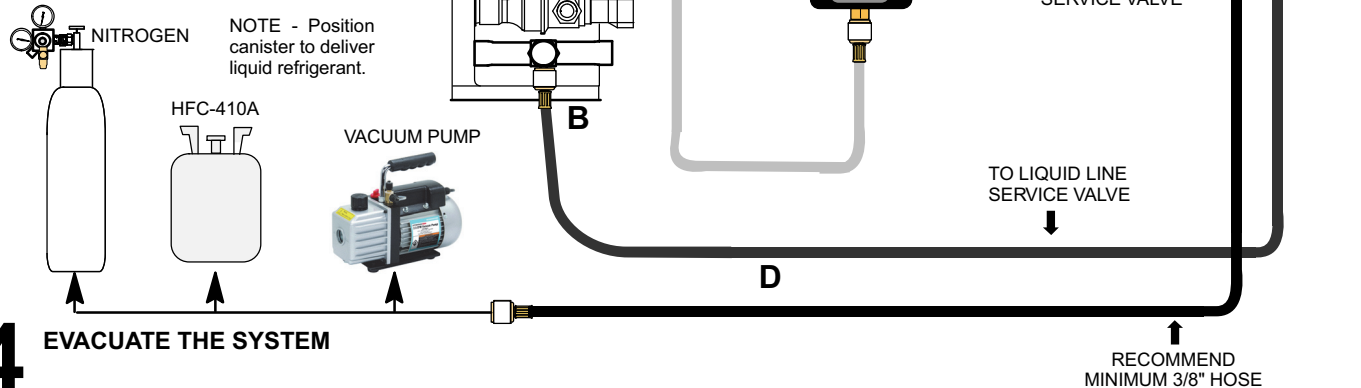

### 4 EVACUATE THE SYSTEM

- Open both manifold valves and start the vacuum pump.
- Evacuate the line set and indoor unit to an **absolute pressure** of 23,000 microns (29.01 inches of mercury).

**NOTE** - During the early stages of evacuation, it is desirable to close the manifold gauge valve at least once. A rapid rise in pressure indicates a relatively large leak. If this occurs, **repeat the leak testing procedure**.

**NOTE** - The term **absolute pressure** means the total actual pressure above absolute zero within a given volume or system. Absolute pressure in a vacuum is equal to atmospheric pressure minus vacuum pressure.

- When the absolute pressure reaches 23,000 microns (29.01 inches of mercury), perform the following:
  - Close manifold gauge valves.
  - Close valve on vacuum pump.
  - Turn off vacuum pump.
  - Disconnect manifold gauge center port hose from vacuum pump.
  - Attach manifold center port hose to a nitrogen cylinder with pressure regulator set to 150 psig (1034 kPa) and purge the hose.
  - Open manifold gauge valves to break the vacuum in the line set and indoor unit.
  - Close manifold gauge valves.
- Shut off the nitrogen cylinder and remove the manifold gauge hose from the cylinder. Open the manifold gauge valves to release the nitrogen from the line set and indoor unit.
- Reconnect the manifold gauge to the vacuum pump, turn the pump on, and continue to evacuate the line set and indoor unit until the absolute pressure does not rise above 500 microns (29.9 inches of mercury) within a 20-minute period after shutting off the vacuum pump and closing the manifold gauge valves.
- When the absolute pressure requirement above has been met, disconnect the manifold hose from the vacuum pump and connect it to a cylinder of HFC-410A positioned to deliver liquid refrigerant. Open the manifold gauge valve 1 to 2 psig in order to release the vacuum in the line set and indoor unit.
- Perform the following:
  - Close manifold gauge valves.
  - Shut off HFC-410A cylinder.
  - Reinstall service valve cores by removing manifold hose from service valve. Quickly install cores with core tool while maintaining a positive system pressure.
  - Replace stem caps and finger tighten them, then tighten an additional one-sixth (1/6) of a turn as illustrated.

### WARNING !

Possible equipment damage.

Avoid deep vacuum operation. Do not use compressors to evacuate a system. Extremely low vacuum can cause internal arcing and compressor failure. Damage caused by deep vacuum operation will void warranty.

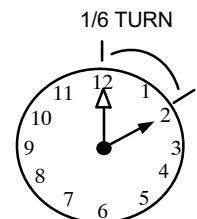

FIGURE 11

## STEP 5 -- ELECTRICAL -- Circuit Sizing and Wire Routing

In the U.S.A., wiring must conform with current local codes and the current National Electric Code (NEC). In Canada, wiring must conform with current local codes and the current Canadian Electrical Code (CEC).

Refer to the furnace or air handler installation instructions for additional wiring application diagrams and refer to unit nameplate for minimum circuit ampacity and maximum overcurrent protection size.

### 24VAC TRANSFORMER

Use the transformer provided with the furnace or air handler for low-voltage control power (24VAC - 40 VA minimum).

## ⚠ WARNING



**Electric Shock Hazard. Can cause injury or death. Unit must be grounded in accordance with national and local codes. Line voltage is present at all components when unit is not in operation on units with single-pole contactors. Disconnect all remote electric power supplies before opening access panel. Unit may have multiple power supplies.**

## IMPORTANT !

**If unit is equipped with a crankcase heater, it should be energized 24 hours before unit start-up to prevent compressor damage as a result of slugging.**

## ⚠ CAUTION

**ELECTROSTATIC DISCHARGE (ESD) Precautions and Procedures**

**Electrostatic discharge can affect electronic components. Take care during unit installation and service to protect the unit's electronic controls. Precautions will help to avoid control exposure to electrostatic discharge by putting the unit, the control and the technician at the same electrostatic potential. Touch hand and all tools on an unpainted unit surface before performing any service procedure to neutralize electrostatic charge.**

## 1 SIZE CIRCUIT AND INSTALL DISCONNECT SWITCH

Refer to the unit nameplate for minimum circuit ampacity, and maximum fuse or circuit breaker (HACR per NEC). Install power wiring and properly sized disconnect switch.

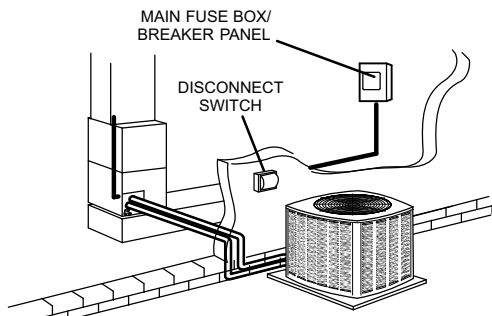

**NOTE - Units are approved for use only with copper conductors. Ground unit at disconnect switch or connect to an earth ground.**

## 2 INSTALL THERMOSTAT

Install room thermostat (ordered separately) on an inside wall approximately in the center of the conditioned area and 5 feet (1.5m) from the floor. It should not be installed on an outside wall or where it can be affected by sunlight or drafts.

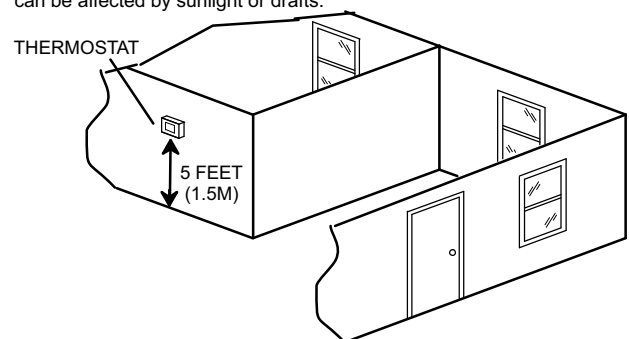

**NOTE - 24VAC, Class II circuit connections are made in the control panel.**

FIGURE 12

# STEP 5 -- ELECTRICAL -- Master Control Jumper and Terminals

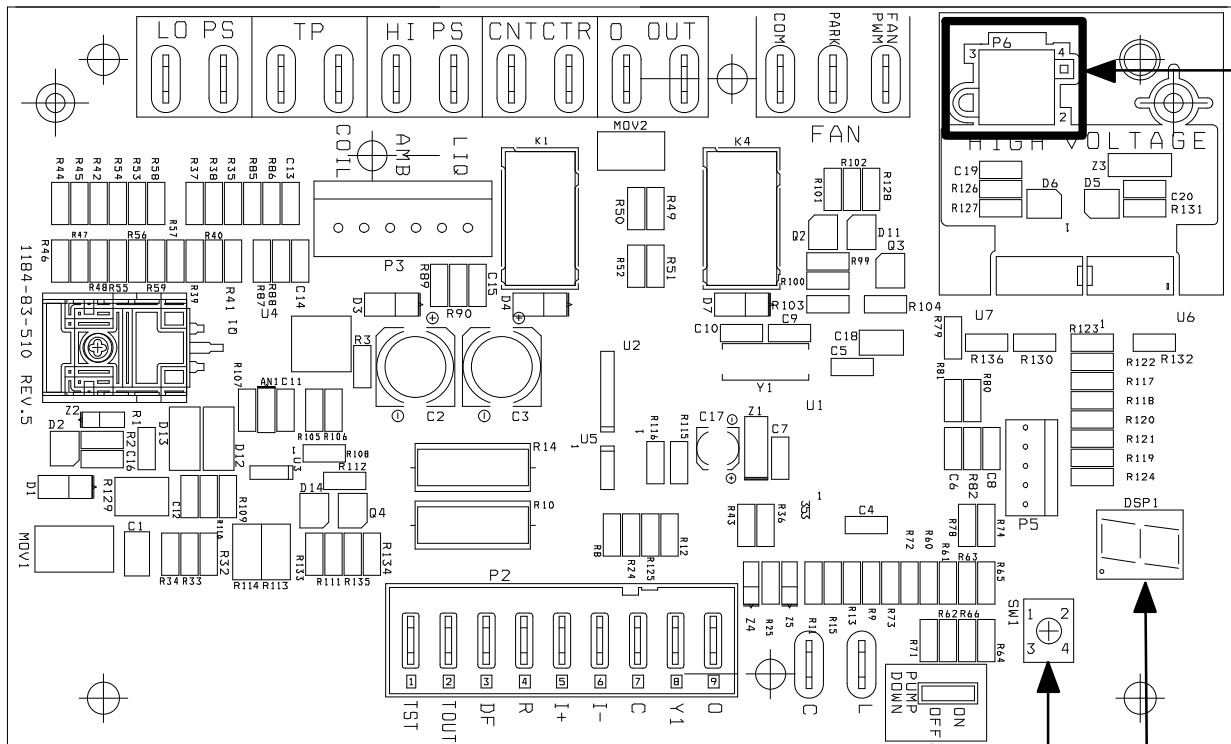

7-SEGMENT DISPLAY

PUSH BUTTON

PUMP DOWN - WHEN UNIT IS IN PUMP DOWN MODE, Pd WILL BE DISPLAYED ON 7-SEGMENT.

TO ACTIVATE PUMP DOWN MODE, THE CONTROL MUST BE IN THE IDLE STATE, AND THE PUMP DOWN JUMPER PLACED ACROSS THE TWO PUMP DOWN PINS. TO DEACTIVATE, REMOVE JUMPER.

DESIG.	DESCRIPTION	INPUT	OUTPUT
O OUT	REVERSING VALVE SWITCHED 24VAC		X
O OUT	REVERSING VALVE COMMON		X
CNTCTR	COMPRESSOR CONTACTOR SWITCHED 24VAC		X
CNTCTR	COMPRESSOR CONTACTOR COMMON		X
TP	THERMAL PROTECTOR SWITCH 24VAC RETURN	X	
TP	THERMAL PROTECTOR SWITCH 24VAC IN SERIES WITH HIGH PRESSURE SWITCH		X
FAN PWM	PWM FAN OUTPUT		X
FAN PARK	PWM FAN PARKING SPOT FOR UNUSED TERMINAL		X
COM	PWM FAN COMMON CONNECTION		X
HI PS	HIGH PRESSURE SWITCH 24VAC IN SERIES WITH CONTACTOR OUTPUT		X
HI PS	HIGH PRESSURE SWITCH 24VAC RETURN	X	
LO PS	LOW PRESSURE SWITCH SENSING VOLTAGE SUPPLY (2.4ma @ 18VAC)		X
LO PS	LOW PRESSURE SWITCH RETURN	X	
L	LOAD SHEDDING 24VAC INPUT	X	
C	LOAD SHEDDING COMMON		X

DESIG.	DESCRIPTION	INPUT	OUTPUT
TST	OEM TEST PIN	X	
TO	26VDC OUTPUT		X
DF	OEM TEST PIN	X	
R	NOMINAL 24VAC	X	
i+	RSBUS DATA HIGH	X	X
i-	RSBUS DATA LOW	X	X
C	NOMINAL 24VAC COMMON	X	
YI	LEGACY 24VAC EMERGENCY INPUT	X	
O	LEGACY 24VAC EMERGENCY INPUT	X	

DESIG.	DESCRIPTION	INPUT	OUTPUT
LIQ	LIQUID LINE TEMPERATURE SENSOR SUPPLY		X
LIQ	LIQUID LINE TEMPERATURE SENSOR RETURN	X	
AMB	OUTDOOR AMBIENT TEMPERATURE SENSOR RETURN		X
AMB	OUTDOOR AMBIENT TEMPERATURE SENSOR SUPPLY	X	
COIL	OUTDOOR COIL TEMPERATURE SENSOR RETURN		X
COIL	OUTDOOR COIL TEMPERATURE SENSOR SUPPLY	X	

DESIG.	DESCRIPTION	PIN	INPUT	OUTPUT
RX	RECEIVE DATA FROM INVERTER	1	X	
TX	TRANSMIT DATA TO INVERTER	3		X
INV GND	INVERTER GROUND	2		X
INV 5V	INVERTER 5 VOLTS	4	X	

FIGURE 13

## 6 ROUTE CONTROL WIRES

Maximum length of wiring (18 gauge) for all connections on the RSBUS is 1500 feet (457 meters). Wires should be color-coded, with a temperature rating of 95°F (35°C) minimum, and solid-core (Class II Rated Wiring). All low voltage wiring must enter unit through field-provided field-installed grommet installed in electrical inlet.

The iComfort Wi-Fi® thermostat requires four thermostat wires between the thermostat and the furnace / air handler iComfort® control and four wires between the outdoor unit and the furnace/air handler iComfort® control. When a thermostat cable with more than four wires is used, the extra wires must be properly connected to avoid electrical noise (see below).

Use a wire nut to bundle the four unused wires at each end of the cable. Each bundle should also include an additional wire that should be connected on each end to the C terminal as shown in the figure below.

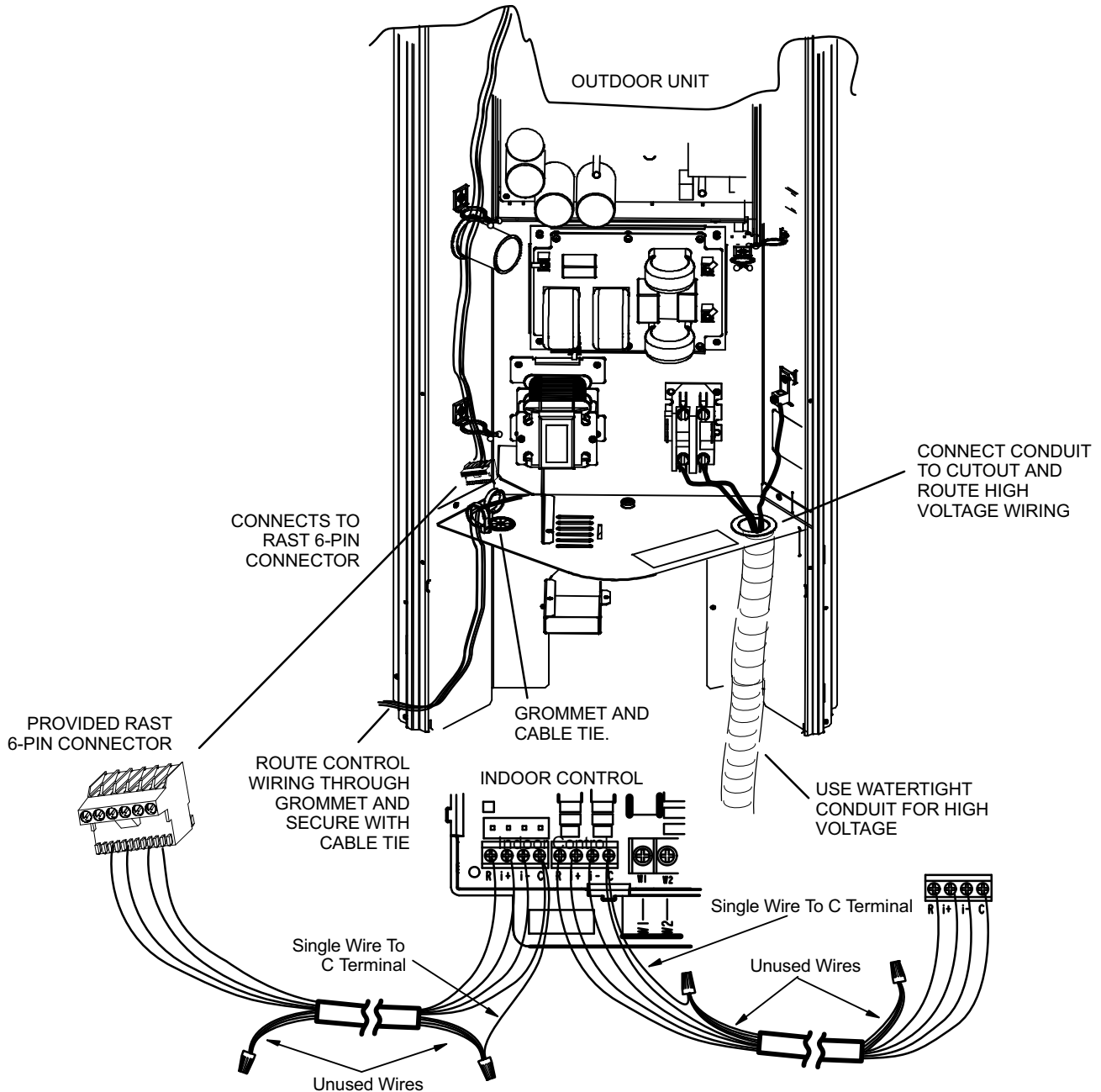

## 7 ROUTE HIGH VOLTAGE AND GROUND WIRES

Any excess high voltage field wiring should be trimmed and secured away from any low voltage field wiring. To facilitate a conduit, a cutout is located on the bottom of the control box. Connect conduit to the control box using a proper conduit fitting.

FIGURE 14

## Heat Pump Control -- Defrost Operation

A full description of the heat pump control can be found in the detailed installation and service procedure manual available on LennoxPROS.com.

The heat pump control (A175) measures differential temperatures to detect when the system is performing poorly because of frost build-up on the outdoor coil. The heat pump control self-calibrates when the defrost system starts and after each system defrost cycle. The heat pump control monitors ambient temperature, outdoor coil temperature, and total run-time to determine when a defrost cycle is required. The coil temperature sensor is designed with a spring clip to allow mounting to the outside coil tubing. The location of the coil sensor is important for proper defrost operation. Detailed information is given in the XP20 Installation and Service Procedures Corp. 1408-L10, which is available on LennoxPROS.com.

**NOTE** - *The heat pump control accurately measures the performance of the system as frost accumulates on the outdoor coil. This typically will translate into longer running time between defrost cycles as more frost accumulates on the outdoor coil before the heat pump control initiates defrost cycles.*

## Charging

The XP20 unit is factory-charged with enough HFC-410A refrigerant to accommodate a 15-foot length of refrigerant piping. Charge should be checked and adjusted using the tables provided on the charging procedure sticker on the unit access panel. Detailed information is provided in the XP20 Installation and Service Procedures manual, which is available on LennoxPROS.com.

## IMPORTANT !

**Room thermostat must be turned down at least 5°F from set point so charging occurs with system operating at 100% capacity. Seven-segment display on outdoor control will show outdoor unit running capacity.**

## Alarms

Alarm information is provided on the outdoor unit access panel and in the iComfort *Wi-Fi*® Installer's System Setup Guide. Detailed alarm information is also available in the XP20 Installation and Service Procedures Corp. 1408-L10, which is available on LennoxPROS.com.

## Outdoor Control Seven-Segment Display and Push Button

Information concerning the outdoor control seven-segment display and push button operations are available on the unit access panel and in the XP20 Installation and Service Procedures Corp. 1408-L10.

## System Component Configuration (Outdoor Unit)

All configuration of the outdoor unit is completed using the iComfort *Wi-Fi*® thermostat. Please refer to the iComfort *Wi-Fi*® Installer's System Setup Guide for complete details on how to integrate this unit into a iComfort®-enabled system.

## Homeowner Information

### ⚠ CAUTION

**Before attempting to perform any service or maintenance, turn the electrical power to unit OFF at disconnect switch.**

### ⚠ WARNING

**This product contains a chemical known to the State of California to cause cancer, birth defects, or other reproductive harm.**

In order to ensure peak performance, your system must be properly maintained. Clogged filters and blocked airflow prevent your unit from operating at its most efficient level. The system should be inspected and serviced before each cooling and heating season by a licensed professional HVAC service technician (or equivalent).

### Heat Pump Operation

Your new Lennox heat pump has several characteristics that you should be aware of:

- Heat pumps satisfy heating demand by delivering large amounts of *warm* air into the living space. This is quite different from gas- or oil-fired furnaces or an electric furnace which deliver lower volumes of considerably *hotter* air to heat the space.
- Do not be alarmed if you notice frost on the outdoor coil in the winter months. Frost develops on the outdoor coil during the heating cycle when temperatures are below 45°F (7°C). The heat pump control activates a defrost cycle lasting 5 to 15 minutes at preset intervals to clear the outdoor coil of the frost.
- During the defrost cycle, you may notice steam rising from the outdoor unit. This is a normal occurrence. The thermostat may engage auxiliary heat during the defrost cycle to satisfy a heating demand; however, the unit will return to normal operation at the conclusion of the defrost cycle.

### Homeowner Maintenance

The following maintenance may be performed by the homeowner.

- Contact a licensed professional HVAC technician to schedule inspection and maintenance appointments for your equipment before each heating and cooling season.
- Check the indoor unit filter each month and replace the filter, if necessary.  
Have your Lennox dealer show you where your indoor unit filter is located. It will be either at the indoor unit (installed internal or external to the cabinet) or behind a return air grille in the wall or ceiling. Check the filter monthly and clean or replace it as needed.  
Disposable filters should be replaced with a filter of the same type and size.

- Check the indoor unit drain line for obstructions monthly during the cooling season.  
The indoor evaporator coil is equipped with a drain pan to collect condensate formed as your system removes humidity from the inside air. Have your dealer show you the location of the drain line and how to check for obstructions. (This would also apply to an auxiliary drain, if installed.)
- Check the area around the outdoor unit monthly and remove any obstructions that may restrict airflow to the outdoor unit. This would include grass clippings, leaves, or papers that may have settled around the unit.
- Trim shrubbery away from the unit and periodically check for debris which collects around the unit.
- During the winter months, keep the snow level below the louvered panels.

**NOTE** - The filter and all access panels must be in place any time the unit is in operation. If you are unsure about the filter required for your system, call your Lennox dealer for assistance.

### IMPORTANT !

**Sprinklers and soaker hoses should not be installed where they could cause prolonged exposure to the outdoor unit by treated water. Prolonged exposure of the unit to treated water (i.e., sprinkler systems, soakers, waste water, etc.) will corrode the surface of steel and aluminum parts, diminish performance and affect longevity of the unit.**

### Thermostat Operation

See the iComfort® thermostat homeowner manual for instructions on how to operate your thermostat.

### Preservice Check

If your system fails to operate, check the following before calling for service:

- Verify room thermostat settings are correct.
- Verify that all electrical disconnect switches are ON.
- Check for any blown fuses or tripped circuit breakers.
- Verify unit access panels are in place.
- Verify air filter is clean.
- If service is needed, locate and write down the unit model number and have it handy before calling.

### Extended Power Outage

The heat pump is equipped with a compressor crankcase heater which protects the compressor during cold weather operation.

If power to your unit has been interrupted for several hours or more, set the room thermostat selector to the EMERGENCY HEAT setting to obtain temporary heat without the risk of serious damage to the heat pump.

In EMERGENCY HEAT mode, all heating demand is satisfied by auxiliary heat; heat pump operation is locked out. After a six-hour compressor crankcase warm-up period, the thermostat can be switched to the HEAT setting and normal heat pump operation may resume.



## Professional Maintenance

Your heat pump system should be inspected and maintained yearly (before the start of the heating and cooling seasons) by a licensed professional HVAC technician. You can expect the technician to check the following items. **These checks may only be conducted by a licensed professional HVAC technician.**

### Outdoor Unit

- A. Inspect component wiring for loose, worn or damaged connections. Also check for any rubbing or pinching of wires. Confirm proper voltage plus amperage outdoor unit.
- B. Check the cleanliness of outdoor fan and blade assemblies. Check condition of fan blades (cracks). Clean or replace them, if necessary.
- C. Inspect base pan drains for debris and clean as necessary.
- D. Inspect the condition of refrigerant piping and confirm that pipes are not rubbing copper-to-copper. Also, check the condition of the insulation on the refrigerant lines. Repair, correct, or replace as necessary.
- E. Test capacitor. Replace as necessary.
- F. Inspect contactor contacts for pitting or burn marks. Replace as necessary.
- G. Check outdoor fan motor for worn bearings/bushings. Replace as necessary.
- H. Inspect and **clean** outdoor coils, if necessary and note any damage to coils or signs of leakage.

### Indoor Unit (Air Handler or Furnace)

- A. Inspect component wiring for loose, worn or damaged connections. Confirm proper voltage plus amperage indoor unit.
- B. Inspect and clean or replace air filters in indoor unit.

- C. Check the cleanliness of indoor blower and clean blower, if necessary.
- D. Inspect the evaporator coil (Indoor) drain pans and condensate drains for rust, debris, obstructions, leaks or cracks. Pour water in pans to confirm proper drainage from the pan through to the outlet of the pipe. Clean or replace as necessary.
- E. Inspect and clean evaporator (indoor) coil, if necessary.
- F. Inspect the condition of the refrigerant lines and confirm that pipes are not rubbing copper-to-copper. Also, ensure that refrigerant pipes are not being affected by indoor air contamination. Check condition of insulation on the refrigerant lines. Repair, correct, or replace as necessary.
- G. Inspect the duct system for leaks or other problems. Repair or replace as necessary.
- H. Check for bearing/bushing wear on indoor blower motor. Replace as necessary.
- I. Indoor unit inspections of gas- or oil-fired furnaces will also include inspection and cleaning of the burners and a full inspection of the gas valve, heat exchanger and flue (exhaust) system.

### General System Test with System Operating

- A. Your technician should perform a general system test. He will turn on the heat pump to check operating functions such as the start-up and shut-off operation. He will also check for unusual noises or odors, and measure indoor/outdoor temperatures and system pressures as needed. He will check the refrigerant charge per the charging sticker information on the outdoor unit.
- B. Verify that system total static pressure and airflow settings are within specific operating parameters.
- C. Verify correct temperature drop across indoor coil.

# ⚠ IMPORTANT

This performance check is **ONLY** valid on systems that have clean indoor and outdoor coils, proper airflow over coils, and correct system refrigerant charge. All components in the system must be functioning properly to correctly perform compressor operational check. (Accurate measurements are critical to this test as indoor system loading and outdoor ambient can affect variations between low and high capacity readings).

## XP20 Start-Up and Performance Checklist

Customer \_\_\_\_\_ Address \_\_\_\_\_  
 Indoor Unit Model \_\_\_\_\_ Serial \_\_\_\_\_  
 Outdoor Unit Model \_\_\_\_\_ Serial \_\_\_\_\_  
 Solar Module Mfg and Model \_\_\_\_\_ Serial \_\_\_\_\_

Notes: \_\_\_\_\_  
 \_\_\_\_\_

### START-UP CHECKS

Refrigerant Type: \_\_\_\_\_  
 Rated Load Amps \_\_\_\_\_ Actual Amps \_\_\_\_\_ Rated Volts \_\_\_\_\_ Actual Volts \_\_\_\_\_  
 Condenser Fan Full Load Amps \_\_\_\_\_ Actual Amps: \_\_\_\_\_

### COOLING MODE

Vapor Pressure: \_\_\_\_\_ Liquid Pressure: \_\_\_\_\_  
 Supply Air Temperature: \_\_\_\_\_ Ambient Temperature: \_\_\_\_\_ Return Air Temperature: \_\_\_\_\_

### HEATING MODE

Vapor Pressure: \_\_\_\_\_ Liquid Pressure: \_\_\_\_\_  
 Supply Air Temperature: \_\_\_\_\_ Ambient Temperature: \_\_\_\_\_ Return Air Temperature: \_\_\_\_\_

System Refrigerant Charge (Refer to manufacturer's information on unit or installation instructions for required subcooling and approach temperatures.)

Subcooling:  

$$\text{Saturated Condensing Temperature (A)} - \text{Liquid Line Temperature (B)} = \text{SUBCOOLING}$$

Approach:  

$$\text{Liquid Line Temperature (A)} - \text{Outdoor Air Temperature (B)} = \text{APPROACH}$$

Indoor Coil Temp. Drop (18 to 22°F)  

$$\text{Return Air Temperature (A)} - \text{Supply Air Temperature (B)} = \text{COIL TEMP DROP}$$

### HIGH-PRESSURE SWITCH (S4)

This unit is equipped with a high-pressure switch which is located on the liquid line. The SPST, normally closed pressure switch opens when liquid line pressure rises above the factory setting of  $590 \pm 15$  psig and automatically resets at  $418 \pm 15$  psig.