



© 2019 Lennox Industries Inc.  
Dallas, Texas USA



# INSTALLATION INSTRUCTIONS EL180UHNE

ELITE® SERIES GAS FURNACE  
UPFLOW / HORIZONTAL AIR DISCHARGE

507647-03  
09/2019  
Supersedes 507647-02

**THIS MANUAL MUST BE LEFT WITH THE  
HOMEOWNER FOR FUTURE REFERENCE**

**!** This is a safety alert symbol and should never be ignored. When you see this symbol on labels or in manuals, be alert to the potential for personal injury or death.

## **!** IMPORTANT

**DO NOT** use the heat exchanger tubes to lift, drag or pull the furnace to its installation location. Doing so may damage or bend the tubes causing noise and or unsafe operation.

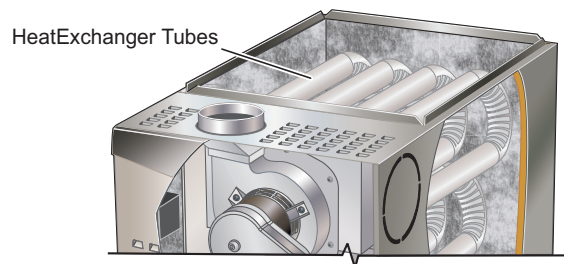
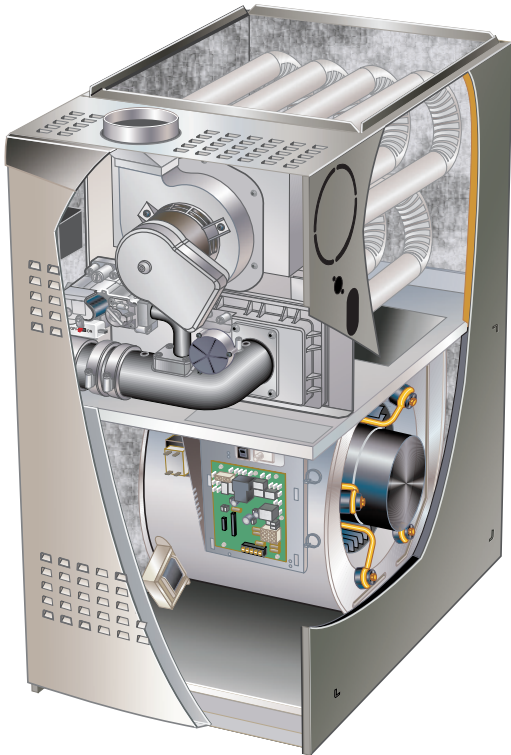

### Contents

Unit Dimensions .....	2
EL180UHN Gas Furnace.....	3
Shipping and Packing List.....	3
Safety .....	3
Use of Furnace as a Construction Heater/ .....	4
General.....	5
Combustion, Dilution, Ventilation Air.....	5
Setting Equipment .....	8
Filters.....	11
Duct System .....	11
Venting Practices.....	14

Gas Piping .....	18
Electrical .....	20
Integrated Control.....	24
Unit Start-Up.....	25
Gas Pressure Measurement.....	26
Proper Combustion.....	26
High Altitude .....	26
Other Unit Adjustments.....	27
Service.....	28
Start-Up Checklist.....	30
Blower Data .....	34



**Unit Dimensions - inches (mm)**

- <sup>1</sup> NOTE - 60C size units that require air volumes over 1800 cfm must have one of the following:
1. Single side return air and Optional Return Air Base with transition that must accommodate required 20 x 25 x 1 inch (508 x 635 x 25 mm) air filter to maintain proper velocity.
  2. Bottom return air.
  3. Return air from both sides.
  4. Bottom and one side return air.
- See Blower Performance Tables for additional information.

<sup>2</sup> Optional External Side Return Air Filter Kit is not for use with the optional Return Air Base.

<sup>3</sup> NOTE - Gas entry is only available on the left side of the cabinet for "A" width cabinet models.

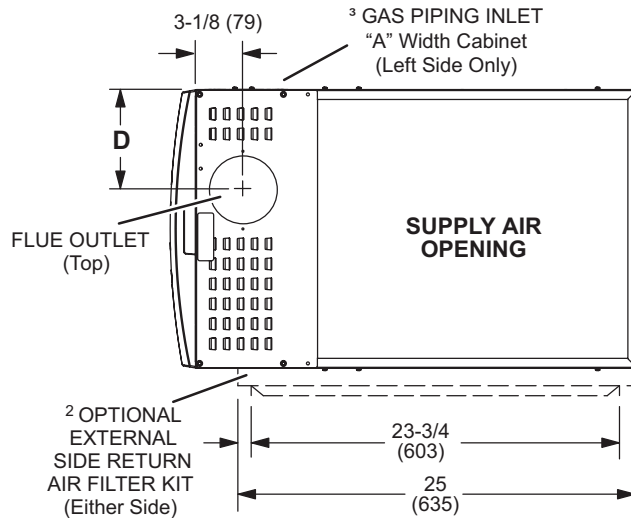

**TOP VIEW**

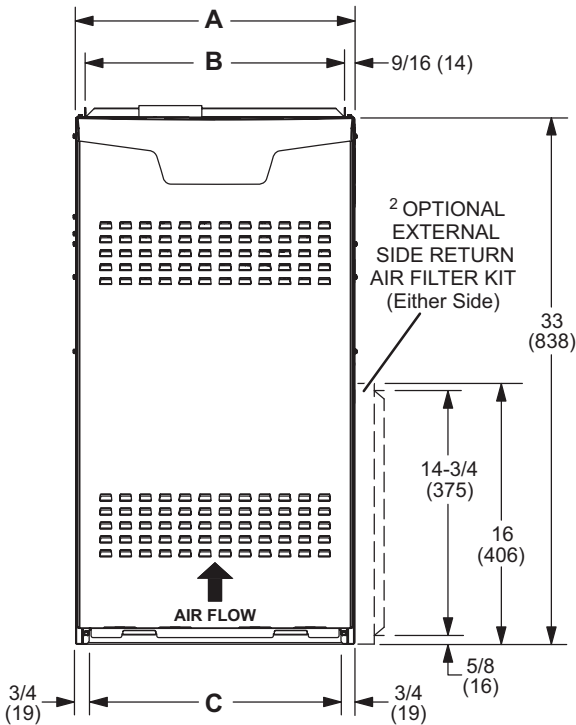

**FRONT VIEW**

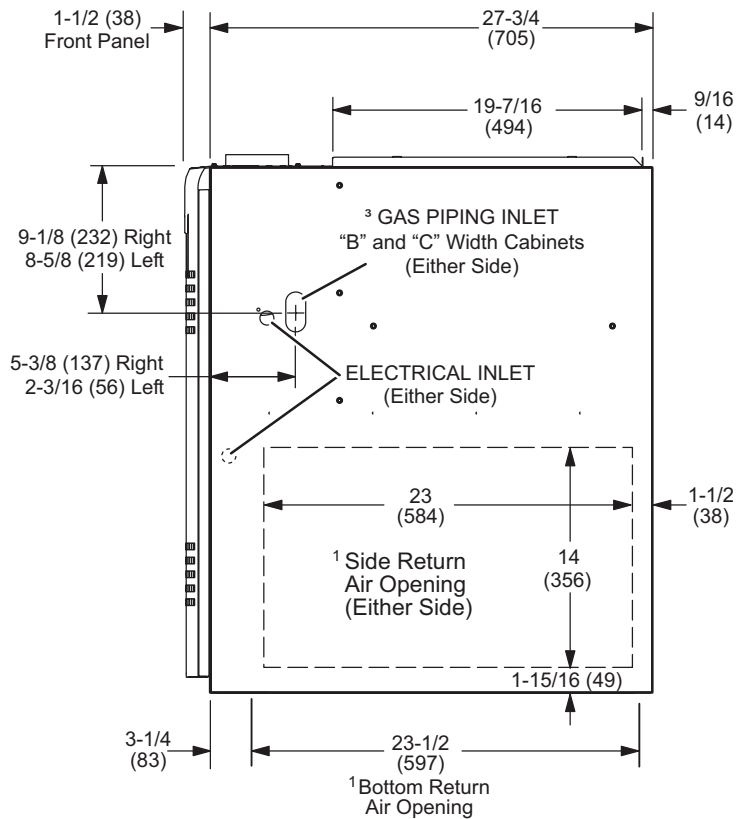

**SIDE VIEW**

EL180UHNE Model	A		B		C		D	
	in	mm	in	mm	in	mm	in	mm
040NE36A 060NE36A	14-1/2	368	13-3/8	340	13	330	4-3/4	121
080NE48B	17-1/2	446	16-3/8	416	16	406	6-1/4	159
100NE60C	21	533	19-7/8	504	19-1/2	495	8	203

## EL180UHNE Gas Furnace

The EL180UHNE unit is shipped ready for installation in the upflow or horizontal position fueled by natural gas. The furnace is shipped with the bottom panel in place. The bottom panel must be removed if the unit is to be installed in a horizontal application. The panel may also be removed in upflow applications. **The EL180UHNE is approved for installations from 0 - 4500 ft. Do not install in high altitude applications.**

## Shipping and Packing List

### Package 1 of 1 contains

- 1 - Assembled EL180UHNE unit
- 1 - Bag assembly containing the following:
  - 2 - Screws
  - 1 - Snap bushing
  - 1 - Snap plug
  - 1 - Wire tie
  - 1 - Vent warning label
  - 1 - Owner's manual and warranty card

The following items may be ordered separately:

- 1 - Thermostat
- 1 - Suspension kit (for horizontal installations)
- 1 - Return air base
- 1 - Side filter kit

Check equipment for shipping damage. If you find any damage, immediately contact the last carrier.

## Safety Information

### **WARNING**

Improper installation, adjustment, alteration, service or maintenance can cause property damage, personal injury or loss of life. Installation and service must be performed by a licensed professional HVAC installer or equivalent, service agency, or the gas supplier.

### **CAUTION**

As with any mechanical equipment, contact with sharp sheet metal edges can result in personal injury. Take care while handling this equipment and wear gloves and protective clothing.

## Certifications

EL180UHNE units are CSA International certified to ANSI Z21.47. In the USA, installation of gas furnaces must conform with local building codes. In the absence of local codes, units must be installed according to the current National Fuel Gas Code (ANSI-Z223.1). The National Fuel Gas Code is available from the following address:

American National Standards Institute, Inc.  
11 West 42nd Street  
New York, NY 10036

## Clearances

Adequate clearance must be made around the air openings into the vestibule area. In order to ensure proper unit operation, combustion and ventilation air supply must be provided according to the current National Fuel Gas Code. Vent installations must be consistent with the National Fuel Gas Code venting tables (in this instruction) and applicable provisions of local building codes.

This furnace is CSA International certified for installation clearances to combustible material as listed on the unit nameplate and in the tables in figures 7 and 11. Accessibility and service clearances must take precedence over fire protection clearances.

**NOTE** - For installation on combustible floors, the furnace shall not be installed directly on carpeting, tile, or other combustible material other than wood flooring.

## Installed Locations

For installation in a residential garage, the furnace must be installed so that the burner(s) and the ignition source are located no less than 18 inches (457 mm) above the floor. The furnace must be located or protected to avoid physical damage by vehicles. When a furnace is installed in a public garage, hangar, or other building that has a hazardous atmosphere, the furnace must be installed according to recommended good practice requirements and current National Fuel Gas Code.

### Temperature Rise

**NOTE** - Furnace must be adjusted to obtain a temperature rise within the range specified on the unit nameplate. Failure to do so may cause erratic limit operation and may result in premature heat exchanger failure.

This EL180UHNE furnace must be installed so that its electrical components are protected from water.

### **CAUTION**

The EL180UHNE is approved for natural gas only. Do not attempt to convert and or install in LP propane applications.

## Installed in Combination with a Cooling Coil

When this furnace is used with cooling units, it shall be installed in parallel with, or on the upstream side of, cooling units to avoid condensation in the heating compartment. See FIGURE 1. With a parallel flow arrangement, a damper (or other means to control the flow of air) must adequately prevent chilled air from entering the furnace. If the damper is manually operated, it must be equipped to prevent operation of either the heating or the cooling unit, unless it is in the full HEAT or COOL setting. See FIGURE 1.

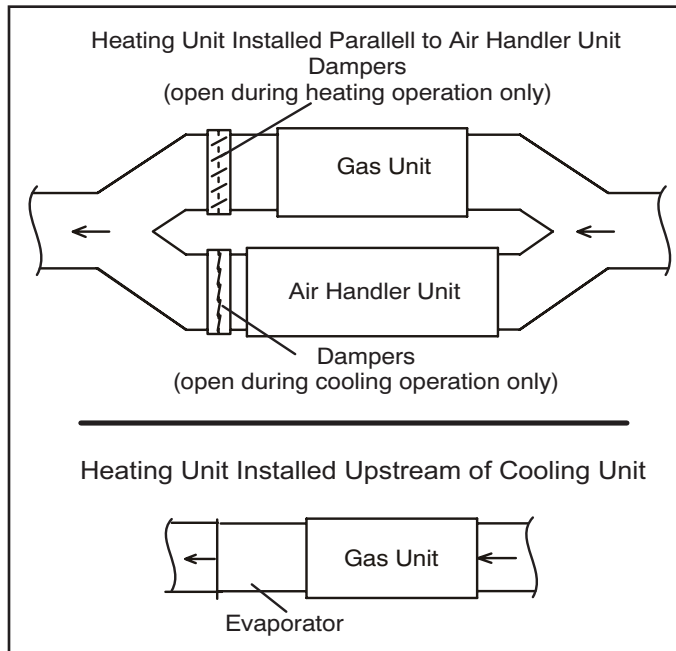

**FIGURE 1**

When installed, this furnace must be electrically grounded according to local codes. In addition, in the United States, installation must conform with the current National Electric Code, ANSI/NFPA No. 70. The National Electric Code (ANSI/NFPA No. 70) is available from the following address:

National Fire Protection Association  
1 Battery March Park  
Quincy, MA 02269

**NOTE** - This furnace is designed for a minimum continuous return air temperature of 60°F (16°C) or an intermittent operation down to 55°F (13°C) dry bulb for cases where a night setback thermostat is used. Return air temperature must not exceed 85°F (29°C) dry bulb.

The EL180UHNE furnace may be installed in alcoves, closets, attics, basements, garages, crawl spaces and utility rooms in the upflow or horizontal position.

**This furnace design has not been CSA International certified for installation in mobile homes, recreational vehicles, or outdoors.**

## Use of Furnace as Construction Heater

Lennox does not recommend the use of EL180UHNE units as a construction heater during any phase of construction. Very low return air temperatures, harmful vapors and operation of the unit with clogged or misplaced filters will damage the unit.

EL180UHNE units may be used for heating of buildings or structures under construction, if the following conditions are met:

- The vent system must be permanently installed per these installation instructions.
- A room thermostat must control the furnace. The use of fixed jumpers that will provide continuous heating is not allowed.
- The return air duct must be provided and sealed to the furnace.
- Return air temperature range between 60°F (16°C) and 80°F (27°C) must be maintained.
- Air filters must be installed in the system and must be maintained during construction.
- Air filters must be replaced upon construction completion.
- The input rate and temperature rise must be set per the furnace rating plate.
- One hundred percent (100%) outdoor air must be provided for combustion air requirements during construction. Temporary ducting may supply outdoor air to the furnace. Do not connect duct directly to the furnace. Size the temporary duct following these instructions in section for Combustion, Dilution and Ventilation Air in a confined space with air from outside.
- The furnace heat exchanger, components, duct system, air filters and evaporator coils must be thoroughly cleaned following final construction clean-up. All furnace operating conditions (including ignition, input rate, temperature rise and venting) must be verified according to these installation instructions.

## General

These instructions are intended as a general guide and do not supersede local codes in any way. Consult authorities having jurisdiction before installation.

In addition to the requirements outlined previously, the following general recommendations must be considered when installing a EL180UHNE furnace:

- Place the furnace as close to the center of the air distribution system as possible. The furnace should also be located close to the chimney or vent termination point.
- Do not install the furnace where drafts might blow directly into it. This could cause improper combustion and unsafe operation.
- Do not block the furnace combustion air openings with clothing, boxes, doors, etc. Air is needed for proper combustion and safe unit operation.
- When the furnace is installed in an attic or other insulated space, keep insulation away from the furnace.
- Please consult the manufacturer of your evaporator coil for their recommendations on distance required between the heat exchanger and their drain pan. Adequate space must be provided between the drain pan and the furnace heat exchanger.

## Combustion, Dilution & Ventilation Air

In the past, there was no problem in bringing in sufficient outdoor air for combustion. Infiltration provided all the air that was needed. In today's homes, tight construction practices make it necessary to bring in air from outside for combustion.

Take into account that exhaust fans, appliance vents, chimneys, and fireplaces force additional air that could be used for combustion out of the house. Unless outside air is brought into the house for combustion, negative pressure (outside pressure is greater than inside pressure) will build to the point that a downdraft can occur in the furnace vent pipe or chimney. As a result, combustion gases enter the living space creating a potentially dangerous situation.

In the absence of local codes concerning air for combustion and ventilation, use the guidelines and procedures in this section to install EL180UHNE furnaces to ensure efficient and safe operation. You must consider combustion air needs and requirements for exhaust vents. A portion of this information has been reprinted with permission from the

National Fuel Gas Code (ANSI-Z223.1). This reprinted material is not the complete and official position of the ANSI on the referenced subject, which is represented only by the standard in its entirety

## CAUTION

Do not install the furnace in a corrosive or contaminated atmosphere. Meet all combustion and ventilation air requirements, as well as all local codes.

## CAUTION

Insufficient combustion air can cause headaches, nausea, dizziness or asphyxiation. It will also cause excess water in the heat exchanger resulting in rusting and premature heat exchanger failure. Excessive exposure to contaminated combustion air will result in safety and performance related problems. Avoid exposure to the following substances in the combustion air supply:

Permanent wave solutions  
Chlorinated waxes and cleaners  
Chlorine base swimming pool chemicals  
Water softening chemicals  
De-icing salts or chemicals  
Carbon tetrachloride  
Halogen type refrigerants  
Cleaning solvents (such as perchloroethylene)  
Printing inks, paint removers, varnishes, etc.  
Hydrochloric acid  
Cements and glues  
Antistatic fabric softeners for clothes dryers  
Masonry acid washing materials

All gas-fired appliances require air for the combustion process. If sufficient combustion air is not available, the furnace or other appliances will operate inefficiently and unsafely. Enough air must be provided to meet the needs of all fuel-burning appliances and appliances such as exhaust fans which force air out of the house. When fireplaces, exhaust fans, or clothes dryers are used at the same time as the furnace, much more air is necessary to ensure proper combustion and to prevent a downdraft. Insufficient air causes incomplete combustion which can result in carbon monoxide.

In addition to providing combustion air, fresh outdoor air dilutes contaminants in the indoor air. These contaminants may include bleaches, adhesives, detergents, solvents and other contaminants which can corrode furnace components.

The requirements for providing air for combustion and ventilation depend largely on whether the furnace is installed in an unconfined or a confined space.

### Unconfined Space

An unconfined space is an area such as a basement or large equipment room with a volume greater than 50 cubic feet (1.42 m<sup>3</sup>) per 1,000 Btu (.29 kW) per hour of the combined input rating of all appliances installed in that space. This space also includes adjacent rooms which are not separated by a door.

Though an area may appear to be unconfined, it might be necessary to bring in outdoor air for combustion if the structure does not provide enough air by infiltration. If the furnace is located in a building of tight construction with weather stripping and caulking around the windows and doors, follow the procedures in the air from outside section.

### Confined Space

A confined space is an area with a volume less than 50 cubic feet (1.42 m<sup>3</sup>) per 1,000 Btu (.29 kW) per hour of the combined input rating of all appliances installed in that space. This definition includes furnace closets or small equipment rooms.

When the furnace is installed so that supply ducts carry air circulated by the furnace to areas outside the space containing the furnace, the return air must be handled by ducts which are sealed to the furnace casing and which terminate outside the space containing the furnace. This is especially important when the furnace is mounted on a platform in a confined space such as a closet or small equipment room.

Even a small leak around the base of the unit at the platform or at the return air duct connection can cause a potentially dangerous negative pressure condition. Air for combustion and ventilation can be brought into the confined space either from inside the building or from outside

### Air from Inside

If the confined space that houses the furnace adjoins a space categorized as unconfined, air can be brought in by providing two permanent openings between the two spaces. Each opening must have a minimum free area of 1 square inch (645 mm<sup>2</sup>) per 1,000 Btu (.29 kW) per hour of total input rating of all gas-fired equipment in the confined space. Each opening must be at least 100 square inches (64516 mm<sup>2</sup>). One opening shall be within 12 inches (305 mm) of the top of the enclosure and one opening within 12 inches (305 mm) of the bottom. See FIGURE 2.

### Air from Outside

If air from outside is brought in for combustion and ventilation, the confined space must have two permanent openings. One opening shall be within 12 inches (305 mm) of the top of the enclosure and one opening within 12 inches (305 mm) of the bottom. These openings must communicate directly or by ducts with the outdoors or spaces (crawl or attic) that freely communicate with the outdoors or indirectly through vertical ducts. Each opening shall have a minimum free area of 1 square inch (645 mm<sup>2</sup>) per 4,000 Btu (1.17 kW) per hour of total input rating of all equipment in the enclosure. See FIGURE 3 and FIGURE 4. When communicating with the outdoors through horizontal ducts, each opening shall have a minimum free area of 1 square inch (645 mm<sup>2</sup>) per 2,000 Btu (.56 kW) per total input rating of all equipment in the enclosure. See FIGURE 5.

When ducts are used, they shall be of the same cross-sectional area as the free area of the openings to which they connect. The minimum dimension of rectangular air ducts shall be no less than 3 inches (75 mm). In calculating free area, the blocking effect of louvers, grilles, or screens must be considered. If the design and free area of protective covering is not known for calculating the size opening required, it may be assumed that wood louvers will have 20 to 25 percent free area and metal louvers and grilles will have 60 to 75 percent free area. Louvers and grilles must be fixed in the open position or interlocked with the equipment so that they are opened automatically during equipment operation.

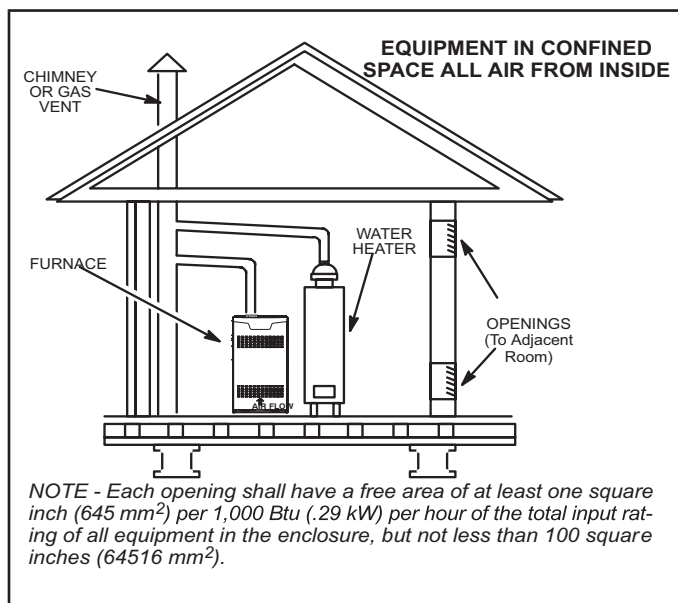
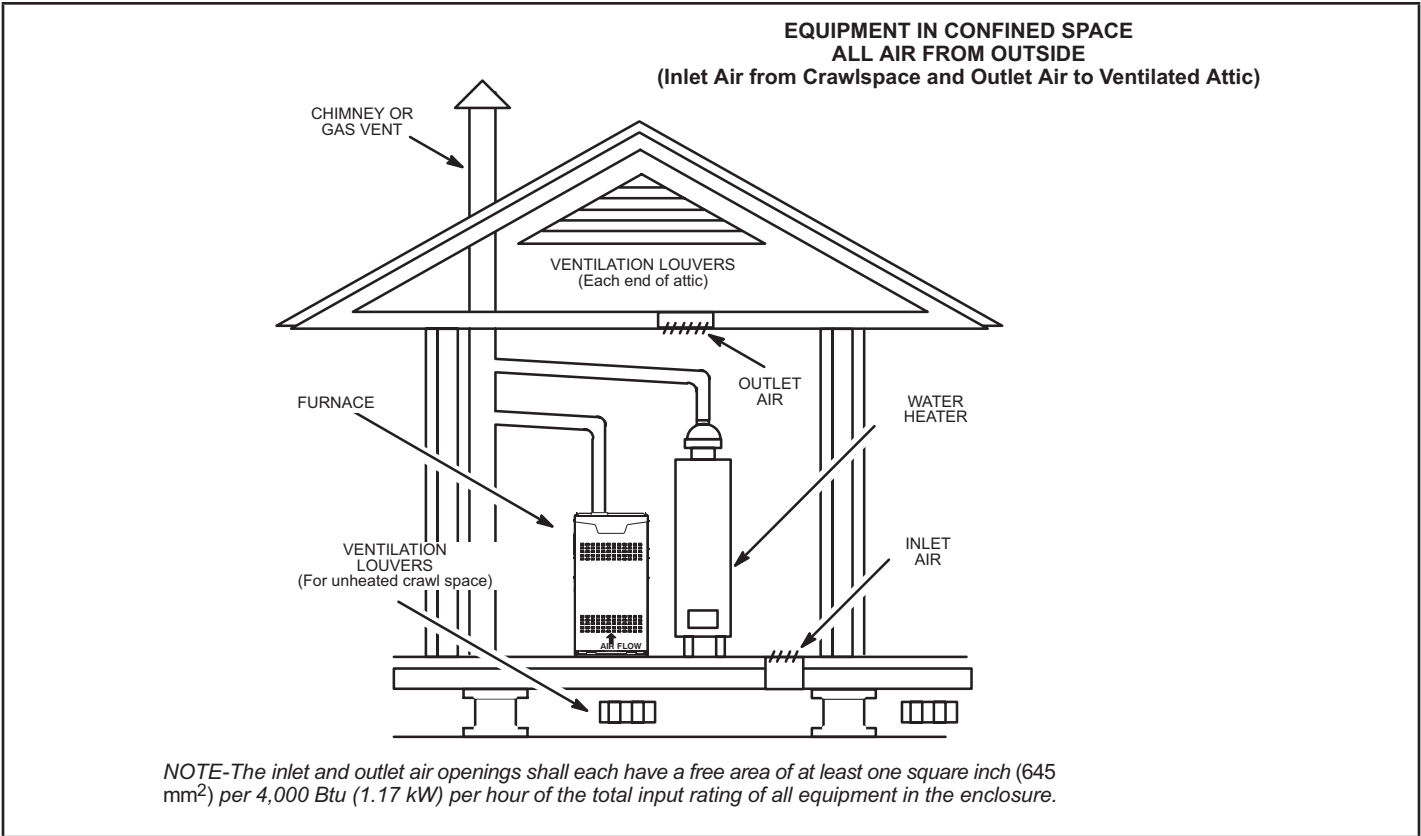
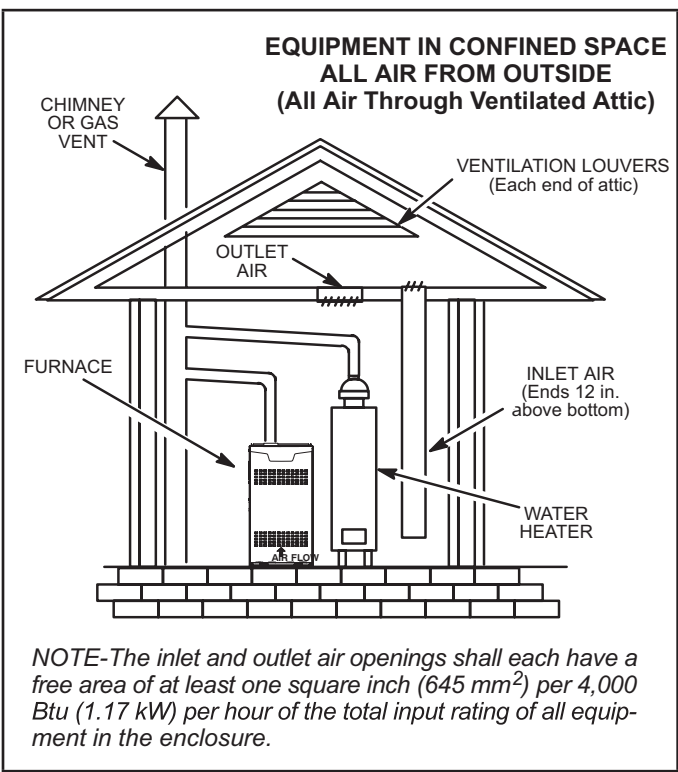

FIGURE 2



**FIGURE 3**



**FIGURE 4**

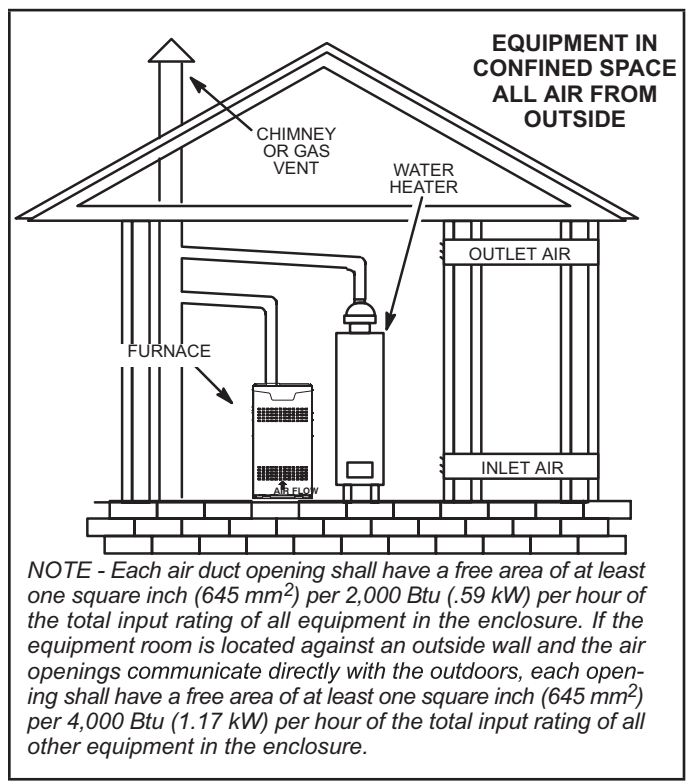

**FIGURE 5**

## Setting Equipment

### **⚠ WARNING**

Do not install the furnace on its front or its back. Do not connect the return air ducts to the back of the furnace. Doing so will adversely affect the operation of the safety control devices, which could result in personal injury or death.

The EL180UHNE gas furnace can be installed as shipped in either the upflow position or the horizontal position.

Select a location that allows for the required clearances that are listed on the unit nameplate. Also consider gas supply connections, electrical supply, vent connection, and installation and service clearances [24 inches (610 mm) at unit front]. The unit must be level.

**NOTE** - Units with 1/2 or 3/4 hp blower motors are equipped with three flexible legs and one rigid leg. See FIGURE 6. The rigid leg is equipped with a shipping bolt and a flat white plastic washer (rather than the rubber mounting grommet used with a flexible mounting leg). **The bolt and washer must be removed before the furnace is placed into operation.** After the bolt and washer have been removed, the rigid leg will not touch the blower housing.

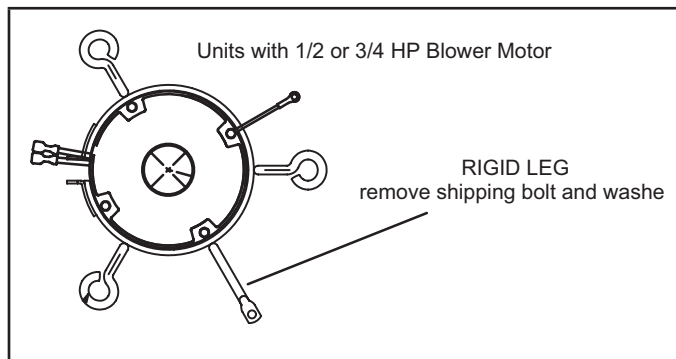

FIGURE 6

## Upflow Applications

Allow for clearances to combustibles materials as indicated on the unit nameplate. Minimum clearances for closet or alcove installations are shown in FIGURE 7.

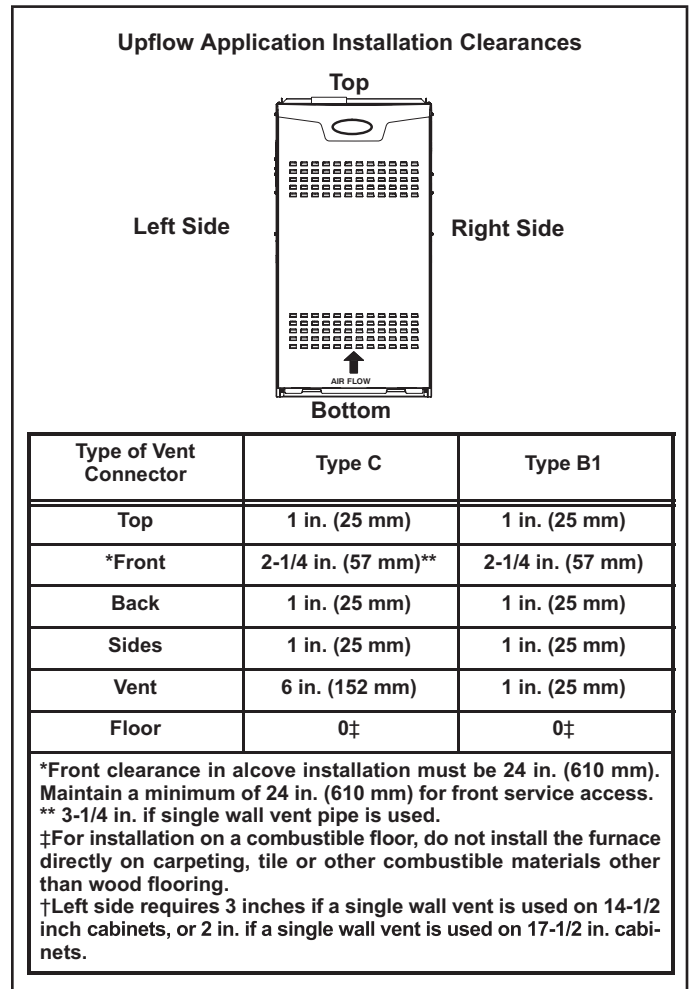

FIGURE 7



## Return Air -- Upflow Applications

Return air can be brought in through the bottom or either side of the furnace installed in an upflow application. If the furnace is installed on a platform with bottom return, make an airtight seal between the bottom of the furnace and the platform to ensure that the furnace operates properly and safely. The furnace is equipped with a removable bottom panel to facilitate installation.

Markings are provided on both sides of the furnace cabinet for installations that require side return air. Cut the furnace cabinet at the maximum dimensions shown on page 2.

**NOTE - 60C units that require air volumes over 1800 cfm (850 L/s) must have one of the following:**

- 1 - Single side return air and optional return air base with transition to accommodate 20 x 25 x 1 in. (508 x 635 x 25 mm) air filter. (Required to maintain proper air velocity.)
- 2 - Bottom return air.
- 3 - Return air from both sides.
- 4 - Bottom and one side return air.

Refer to Engineering Handbook for additional information.

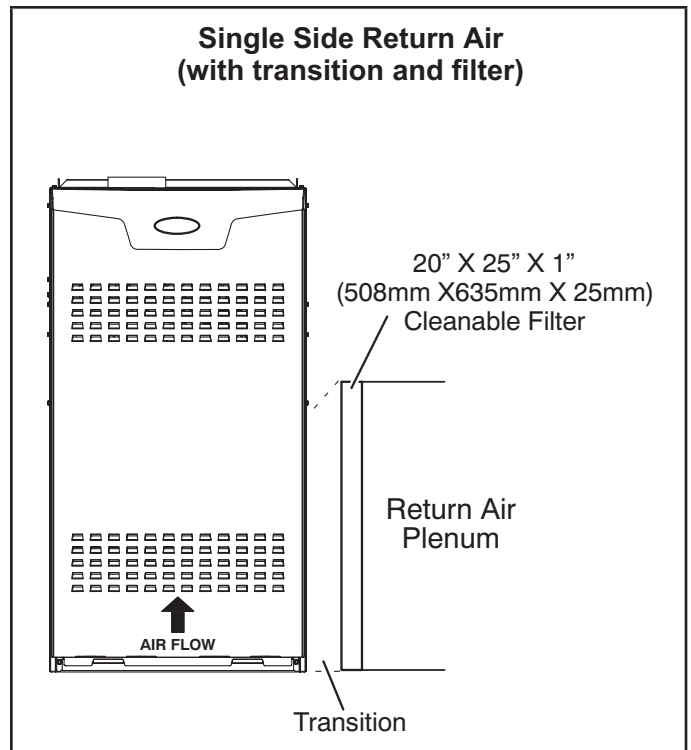

FIGURE 8

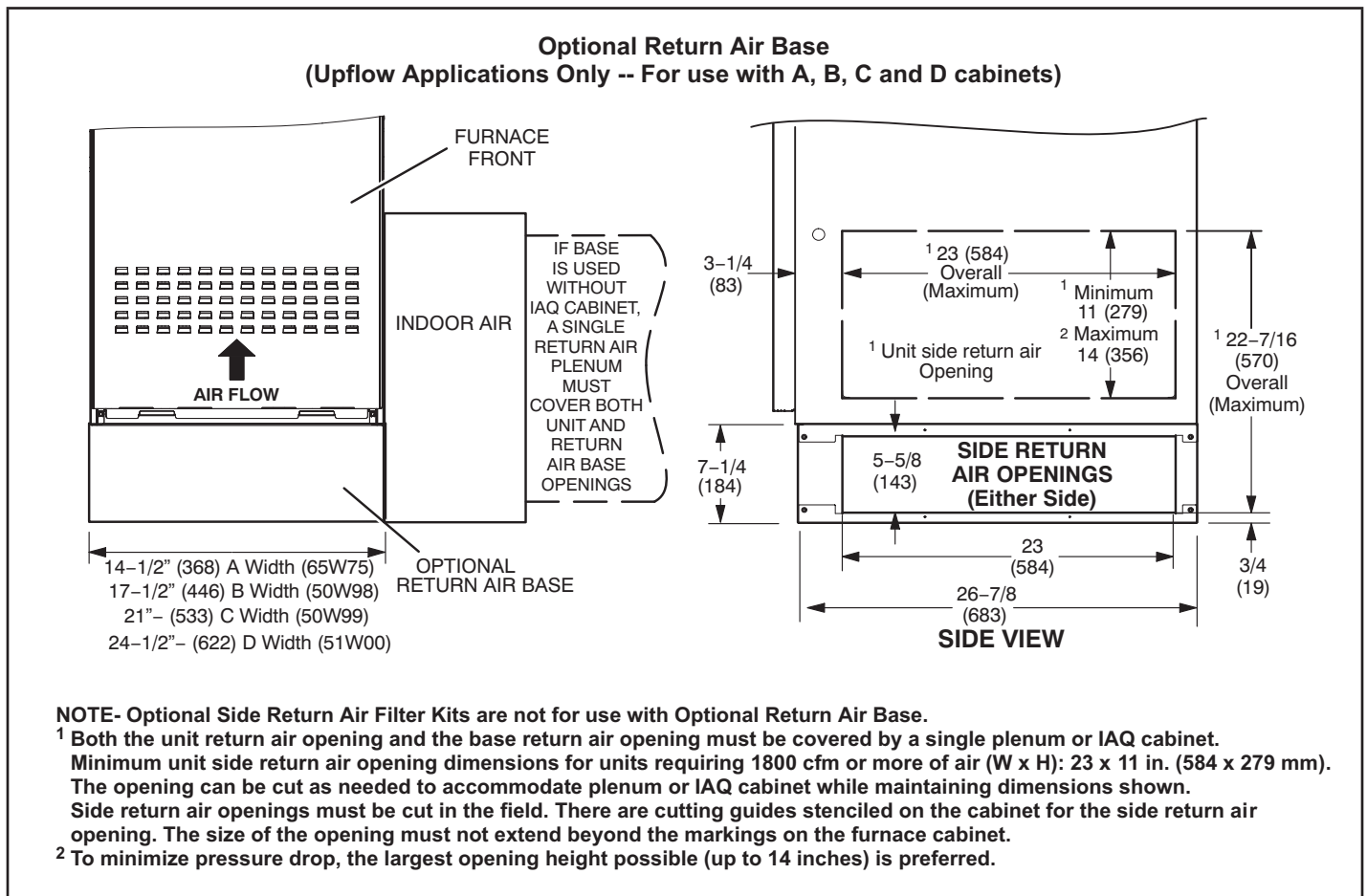

FIGURE 9

## Removing the Bottom Panel

Remove the two screws that secure the bottom cap to the furnace. Pivot the bottom cap down to release the bottom panel. Once the bottom panel has been removed, reinstall the bottom cap. See FIGURE 10.

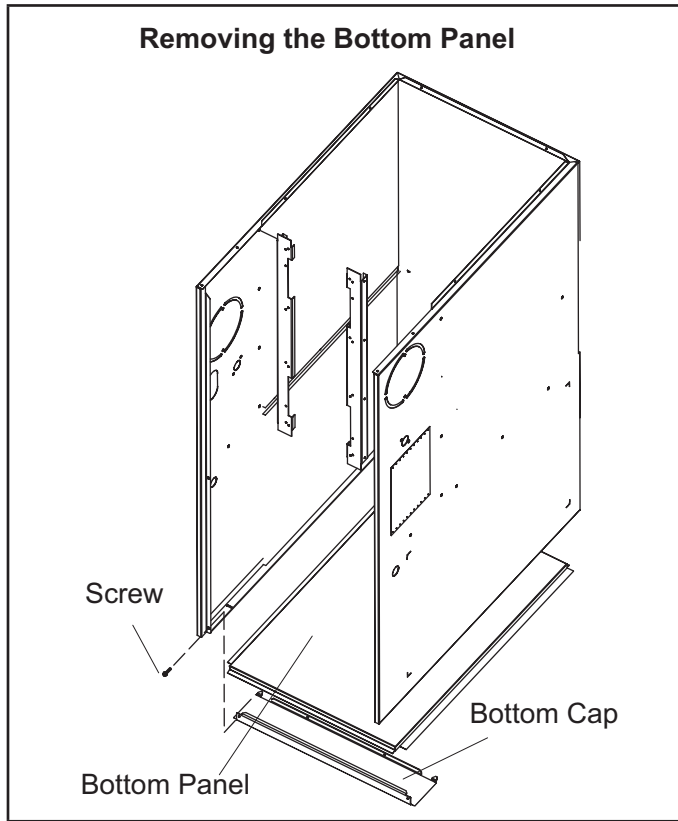

FIGURE 10

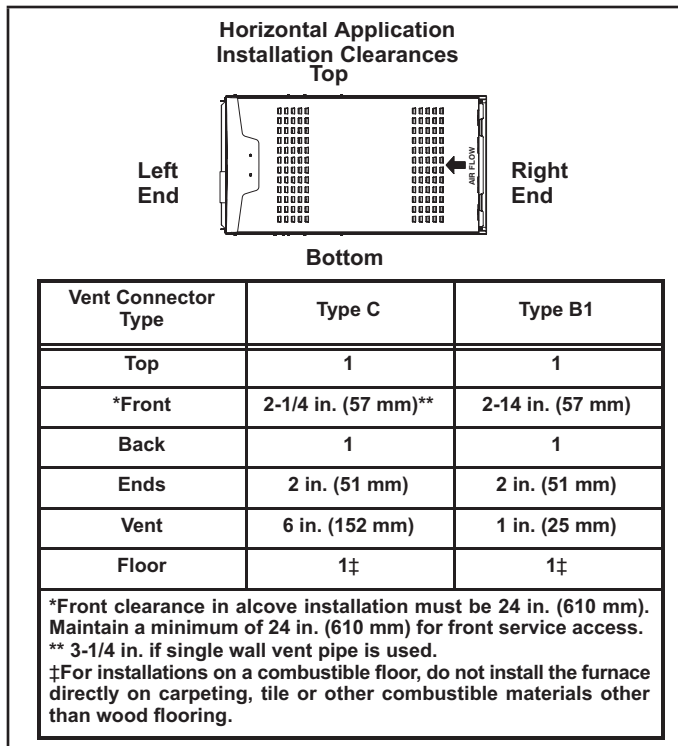

FIGURE 11

## Horizontal Applications

The EL180UHNE furnace can be installed in horizontal applications. Order horizontal suspension kit (51W10) from Lennox, or use equivalent suspension method.

Allow for clearances to combustible materials as indicated on the unit nameplate. Minimum clearances for closet or alcove installations are shown in FIGURE 11.

This furnace may be installed in either an attic or a crawlspace. Either suspend the furnace from roof rafters or floor joists, as shown in FIGURE 12, or install the furnace on a platform, as shown in FIGURE 13.

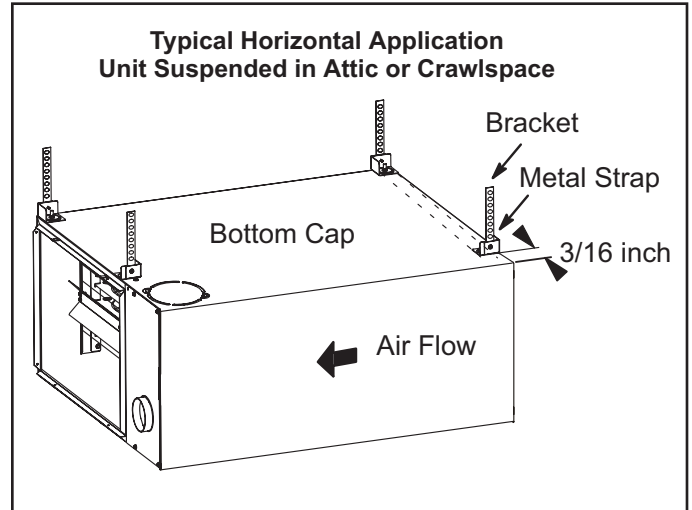

FIGURE 12

**NOTE** - Heavy-gauge perforated sheet metal straps may be used to suspend the unit from roof rafters or ceiling joists. When straps are used to suspend the unit in this way, support must be provided for both the ends. The straps must not interfere with the plenum or exhaust piping installation. Cooling coils and supply and return air plenums must be supported separately.

**NOTE** - When the furnace is installed on a platform in a crawlspace, it must be elevated enough to avoid water damage and to allow the evaporator coil to drain.

## Return Air -- Horizontal Applications

Return air must be brought in through the end of a furnace installed in a horizontal application. The furnace is equipped with a removable bottom panel to facilitate installation. See figure 10.

## ⚠ CAUTION

If this unit is being installed in a space serviced by an exhaust fan, power exhaust fan, or other device which may create a negative pressure in the space, take care when sizing the inlet air opening. The inlet air opening must be sized to accommodate the maximum volume of exhausted air as well as the maximum volume of combustion air required for all gas appliances serviced by this space.

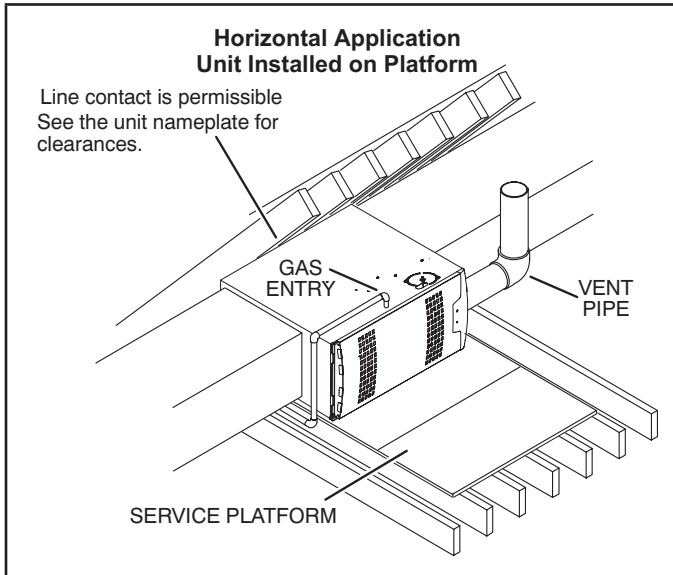

FIGURE 13

## ⚠ WARNING

Improper installation of the furnace can result in personal injury or death. Combustion and flue products must never be allowed to enter the return air system or the living space. Use screws and joint tape to seal the return air system to the furnace.

In platform installations with bottom return air, the furnace should be sealed airtight to the return air plenum. A door must never be used as a portion of the return air duct system. The base must provide a stable support and an airtight seal to the furnace. Allow absolutely no sagging, cracks, gaps, etc.

The return and supply air duct systems must never be connected to or from other heating devices such as a fireplace or stove, etc. Fire, explosion, carbon monoxide poisoning, personal injury and/or property damage could result.

## ⚠ WARNING

The blower access panel must be securely in place when the blower and burners are operating. Gas fumes, which could contain carbon monoxide, can be drawn into living space resulting in personal injury or death.

## Filters

This unit is not equipped with a filter or rack. A field-provided high-velocity filter is required for the unit to operate properly. TABLE 1 lists recommended filter sizes.

## ⚠ IMPORTANT

If a high-efficiency filter is being installed as part of this system to ensure better indoor air quality, the filter must be properly sized. High-efficiency filters have a higher static pressure drop than standard efficiency glass/foam filters. If the pressure drop is too great, system capacity and performance may be reduced. The pressure drop may also cause the limit to trip more frequently during the winter and the indoor coil to freeze in the summer, resulting in an increase in the number of service calls.

Before using any filter with this system, check the specifications provided by the filter manufacturer against the data given in the appropriate Lennox Product Specifications bulletin. Additional information is provided in Service and Application Note ACC002 (August 2000).

A filter must be in place any time the unit is operating.

TABLE 1

Furnace Cabinet Width	Filter Size	
	Side Return	Bottom Return
A - 14-1/2"	16 X 25 X 1 (1)	14 X 25 X 1 (1)
B - 17-1/2"	16 X 25 X 1 (1)	16 X 25 X 1 (1)
C - 21"	16 X 25 X 1 (1)	20 X 25 X 1 (1)

## Duct System

Use industry-approved standards (such as those published by Air Conditioning Contractors of America or American Society of Heating, Refrigerating and Air Conditioning Engineers) to size and install the supply and return air duct system. FIGURE 14 shows the correct supply and return duct installation. This will result in a quiet and low-static system that has uniform air distribution.

**NOTE** - Do not operate the furnace in the heating mode with an external static pressure that exceeds 0.5 inches w.c. Higher external static pressures may cause erratic limit operation.

### Supply Air Plenum

If the furnace is installed without a cooling coil, a removable access panel must be installed in the supply air duct. The access panel should be large enough to permit inspection (either by smoke or reflected light) of the heat exchanger for leaks after the furnace is installed. The furnace access panel must always be in place when the furnace is operating and it must not allow leaks into the supply air duct system.

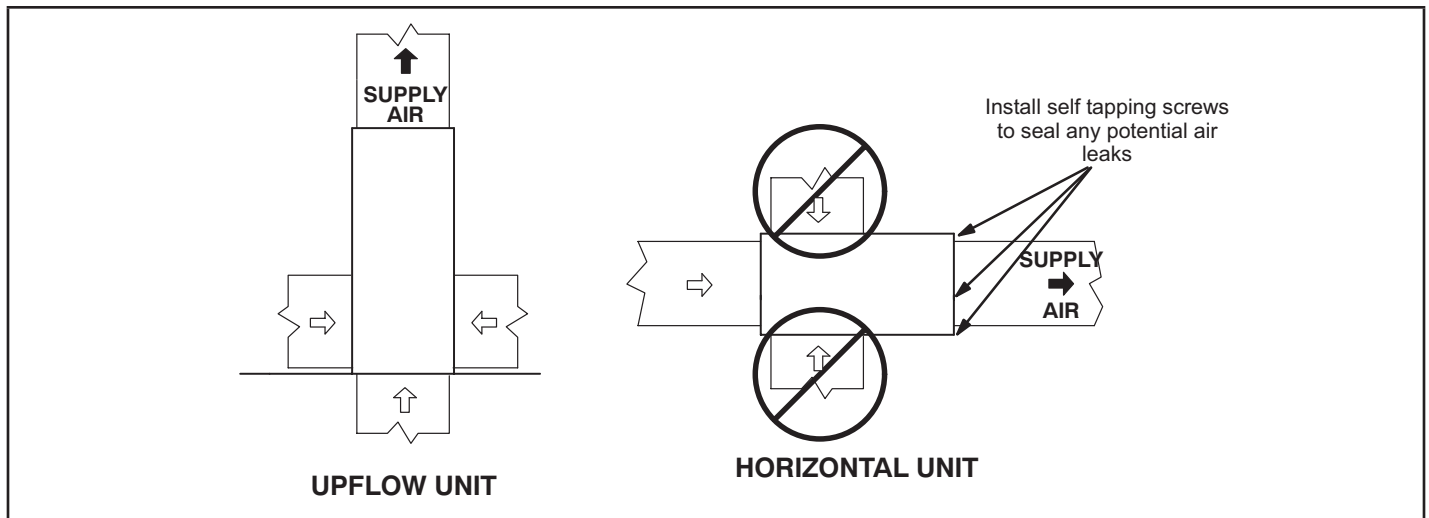

FIGURE 14

### Return Air Plenum

**NOTE** - Return air must not be drawn from a room where this furnace, or any other gas-fueled appliance (i.e., water heater), or carbon monoxide producing device (i.e., wood fireplace) is installed.

When return air is drawn from a room, a negative pressure is created in the room. If a gas appliance is operating in a room with negative pressure, the flue products can be pulled back down the vent pipe and into the room. This reverse flow of the flue gas may result in incomplete combustion and the formation of carbon monoxide gas. This toxic gas might then be distributed throughout the house by the furnace duct system.

In upflow applications, the return air can be brought in through the bottom or either side of the furnace. If a furnace with bottom return air is installed on a platform, make an airtight seal between the bottom of the furnace and the platform to ensure that the unit operates properly and safely. Use fiberglass sealing strips, caulking, or equivalent sealing method between the plenum and the furnace cabinet to ensure a tight seal. If a filter is installed, size the return air duct to fit the filter frame.

### Venting

A 4-inch diameter flue transition is factory-installed on the combustion air inducer outlet of all models

The EL180UHNE series units are classified as fan-assisted Category I furnaces when vertically vented according to the latest edition of National Fuel Gas Code (NFPA 54 / ANSI Z223.1) in the USA. A fan-assisted Category I furnace is an appliance equipped with an integral mechanical means to either draw or force combustion products through the combustion chamber and/or heat exchanger. The EL180UHNE is not approved for use with horizontal venting.

**NOTE** - Use these instructions as a guide. They do not supersede local codes. This furnace must be vented according to all local codes these installation instructions, and the provided venting tables in these instructions

The venting tables in this manual were extracted from the National Fuel Gas Code (NFPA 54 / ANSI Z223.1) and are provided as a guide for proper vent installation. Proper application, termination, construction and location of vents must conform to local codes having jurisdiction. In the absence of local codes, the NFGC serves as the defining document.

Use self-drilling sheet metal screws or a mechanical fastener to firmly secure the vent pipe to the round collar of the flue transition. If self-drilling screws are used to attach the vent pipe, it is recommended that three be used. Drive one self-drilling screw through the front and one through each side of the vent pipe and collar. See FIGURE 15.

Install the first vent connector elbow at a minimum of six inches (152 mm) from the furnace vent outlet. See figure 15.

### Venting Using a Masonry Chimney

The following additional requirements apply when a lined masonry chimney is used to vent this furnace. Masonry chimneys used to vent Category I central furnaces must be either tile-lined or lined with a listed metal lining system or dedicated gas vent. Unlined masonry chimneys are prohibited. See FIGURE 16 and FIGURE 17 for common venting.

A chimney with one or more sides exposed to the outside of the structure is considered to be an exterior chimney. An exterior masonry chimney that is not tile-lined must be lined with B1 vent or a listed insulated flexible metal vent. An exterior tile-lined chimney that is sealed and capped may be lined with a listed uninsulated flexible metal vent. If the existing chimney will not accommodate a listed metal liner, either the chimney must be rebuilt to accommodate one of these liners or an alternate approved venting method must be found.

Insulation for the flexible vent pipe must be an encapsulated fiberglass sleeve recommended by the flexible vent pipe manufacturer. See FIGURE 16. Refer to the tables and the venting information contained in these instructions to properly size and install the venting system.

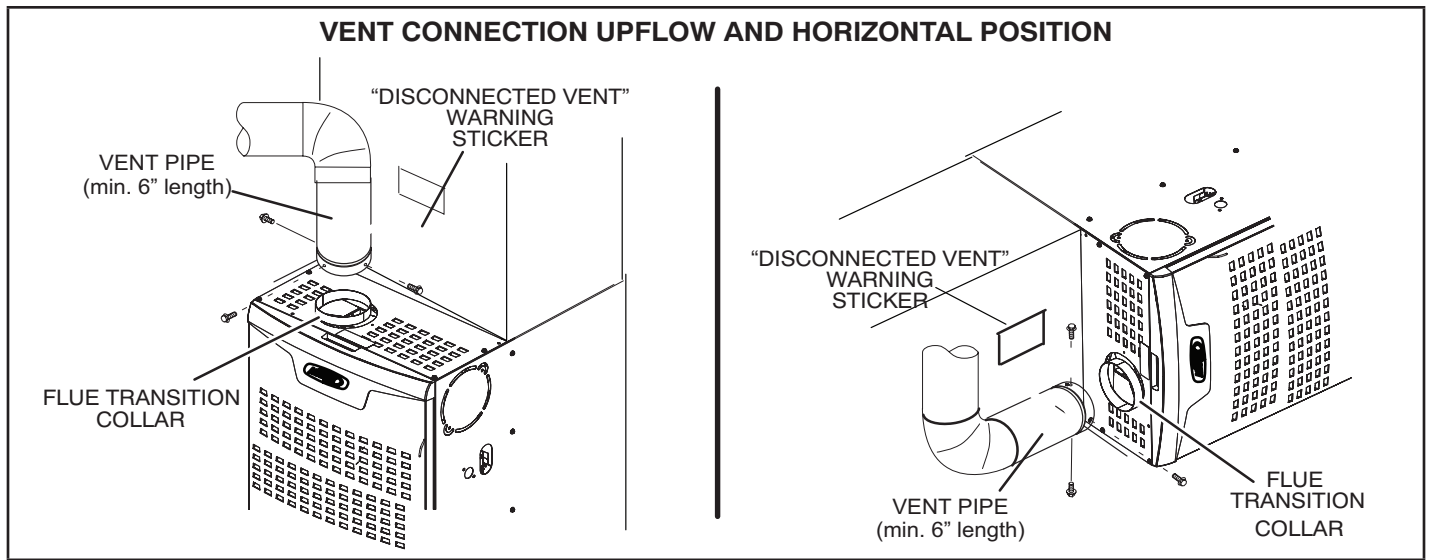

FIGURE 15

**⚠ IMPORTANT**  
 Once the venting system is installed, attach the “Disconnected Vent” warning sticker to a visible area of the plenum near the vent pipe. See figure 15. The warning sticker is provided in the bag assembly. Order kit 66W04 for additional stickers.

**DO NOT** insulate the space between the liner and the chimney wall with puffed mica or any other loose granular insulating material.

**⚠ IMPORTANT**  
 SINGLE appliance venting of a fan-assisted furnace into a tile-lined masonry chimney (interior or outside wall) is PROHIBITED. The chimney must first be lined with either type B1 vent or an insulated single wall flexible vent lining system which has been sized according to the provided venting tables and the vent pipe manufacturer’s instructions.

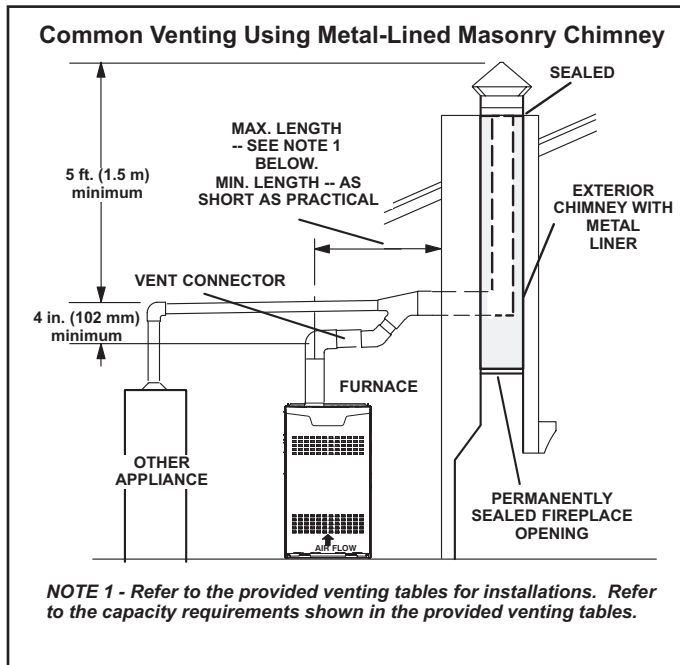

FIGURE 16

**⚠ WARNING**  
 Asphyxiation hazard. The exhaust vent for this furnace must be securely connected to the furnace flue transition at all times.

A fan-assisted furnace may be commonly vented into an existing lined masonry chimney if the following conditions are met:

- The chimney is currently serving at least one draft-hoodequipped appliance;
- The vent connectors and chimney are sized according to the provided venting tables.

If type B1 double-wall vent is used inside a chimney, no other appliance can be vented into the chimney. The outer wall of type B1 vent pipe must not be exposed to flue products.

A type B1 vent or masonry chimney liner shall terminate above the roof surface with a listed cap or a listed roof assembly according to the terms of their respective listings and the vent manufacturer’s instructions.

When inspection reveals that an existing chimney is not safe for the intended purpose, it shall be rebuilt to conform to nationally recognized standards, lined or relined with suitable materials, or replaced with a gas vent or chimney suitable for venting EL180UHNE series units. The chimney passageway must be checked periodically to ensure that it is clear and free of obstructions.

Do not install a manual damper, barometric draft regulator, or flue restrictor between the furnace and the chimney.

Never connect a Category I appliance to a chimney that is servicing a solid-fuel appliance. If a fireplace chimney flue is used to vent this appliance, the fireplace opening must be permanently sealed.

A type B or listed chimney lining system that passes through an unused masonry chimney flue is not considered to be exposed to the outdoors.

### General Venting Requirements

Vent all EL180UHNE furnaces according to these instructions:

- 1 - Vent diameter recommendations and maximum allowable piping runs are found in the provided venting tables.
- 2 - In no case should the vent or vent connector diameter be less than the diameter specified in the provided venting tables.
- 3 - The minimum vent capacity determined by the sizing tables must be less than the low fire input rating and the maximum vent capacity must be greater than the high fire input rating.
- 4 - Single appliance vents - If the vertical vent or tile-lined chimney has a larger diameter or flow area than the vent connector, use the vertical vent diameter to determine the minimum vent capacity and the vent connector diameter to determine the maximum vent capacity. The flow area of the vertical vent, however, shall not exceed 7 times the flow area of the listed appliance categorized vent area, draft hood outlet area or flue collar area unless designed according to approved engineering methods.

5 - Multiple appliance vents - The flow area of the largest section of vertical vent or chimney shall not exceed 7 times the smallest listed appliance categorized vent area, draft hood outlet area or flue collar area unless designed according to approved engineering methods.

6 - The entire length of single wall metal vent connector shall be readily accessible for inspection, cleaning, and replacement.

7 - Single appliance venting configurations with zero lateral lengths (TABLE 3) are assumed to have no elbows in the vent system. For all other vent configurations, the vent system is assumed to have two 90° elbows. For each additional 90° elbow or equivalent (for example two 45° elbows equal one 90° elbow) beyond two, the maximum capacity listed in the venting table should be reduced by 10% (0.90 x maximum listed capacity).

8 - The common venting TABLE 4 and TABLE 5 were generated using a maximum horizontal vent connector length of 1-1/2 feet (.46 m) for each inch (25 mm) of connector diameter as follows:

**TABLE 2**

Connector Diameter inches (mm)	Maximum Horizontal Connector Length feet (m)
3 (76)	4-1/2 (1.37)
4 (102)	6 (1.83)
5 (127)	7-1/2 (2.29)
6 (152)	9 (2.74)
7 (178)	10-1/2 (3.20)

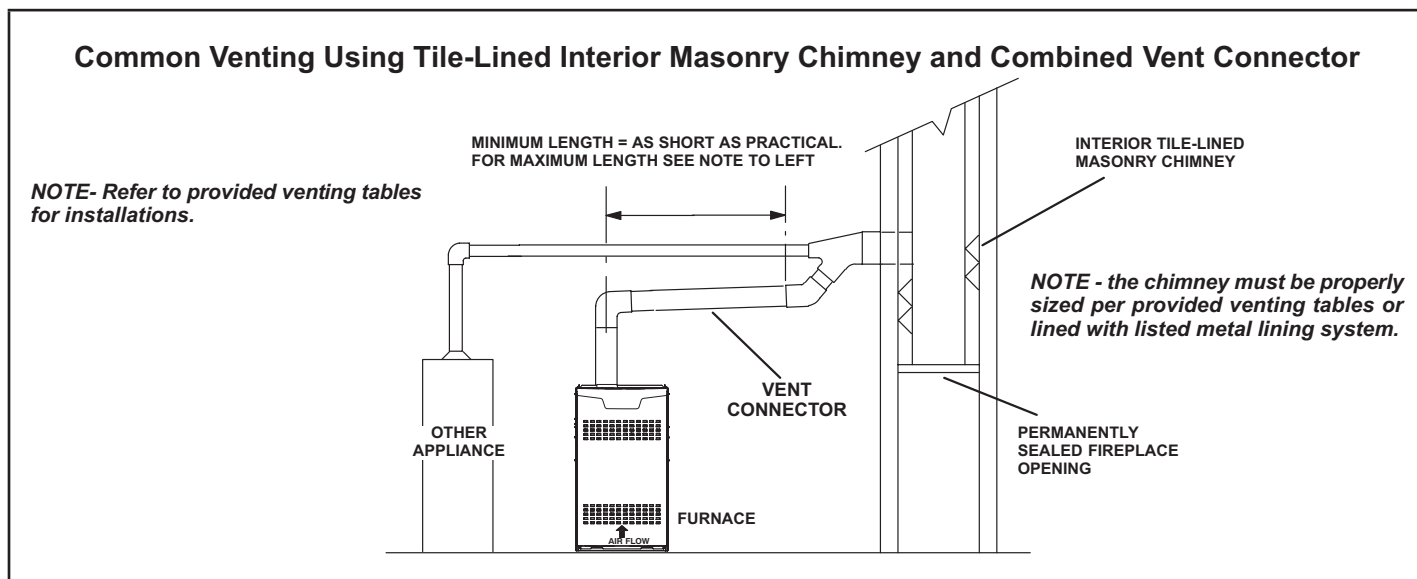

**FIGURE 17**

- 9 - If the common vertical vent is offset, the maximum common vent capacity listed in the common venting tables should be reduced by 20%, the equivalent of two 90° elbows (0.80 x maximum common vent capacity). The horizontal length of the offset shall not exceed 1-1/2 feet (.46 m) for each inch (25 mm) of common vent diameter.
- 10 - The vent pipe should be as short as possible with the least number of elbows and angles required to complete the job. Route the vent connector to the vent using the shortest possible route.
- 11 - A vent connector shall be supported without any dips or sags and shall slope a minimum of 1/4 inch (6.4 mm) per linear foot (305 mm) of connector, back toward the appliance.
- 12 - Vent connectors shall be firmly attached to the furnace flue collar by self-drilling screws or other approved means, except vent connectors of listed type B vent material which shall be assembled according to the manufacturer's instructions. Joints between sections of single wall connector piping shall be fastened by screws or other approved means.
- 13 - When the vent connector used for Category I appliances must be located in or pass through a crawlspace, attic or other areas which may be cold, that portion of the vent connector shall be constructed of listed double-wall type B vent material or material having equivalent insulation qualities.
- 14 - All venting pipe passing through floors, walls, and ceilings must be installed with the listed clearance to combustible materials and be fire stopped according to local codes. In absence of local codes, refer to NFGC (Z223.1).
- 15 - No portion of the venting system can extend into, or pass through any circulation air duct or plenum.
- 16 - Vent connectors serving Category I appliances shall not be connected to any portion of mechanical draft systems operating under positive pressure such as Category III or IV venting systems.
- 17 - If vent connectors are combined prior to entering the common vent, the maximum common vent capacity listed in the common venting tables must be reduced by 10%, the equivalent of one 90° elbow (0.90 x maximum common vent capacity).
- 18 - The common vent diameter must always be at least as large as the largest vent connector diameter.
- 19 - In no case, shall the vent connector be sized more than two consecutive table size diameters over the size of the draft hood outlet or flue collar outlet.
- 20 - Do not install a manual damper, barometric draft regulator or flue restrictor between the furnace and the chimney.
- 21 - When connecting this appliance to an existing dedicated or common venting system, you must inspect the venting system's general condition and look for signs of corrosion. The existing vent pipe size must conform to these instructions and the provided venting tables. If the existing venting system does not meet these requirements, it must be resized.

**TABLE 3**  
Capacity of Type B Double-Wall Vents with Type B Double-Wall Connectors  
Serving a Single Category I Appliance

Height H (feet)	Lateral L (feet)	Vent and Connector Diameter - D (inches)							
		3 inch		4 inch		5 inch		6 inch	
		Appliance Input Rating in Thousands of Btu Per Hour							
		Min	Max	Min	Max	Min	Max	Min	Max
6	0	0	78	0	152	0	251	0	375
	2	13	51	18	97	27	157	32	232
	4	21	49	30	94	39	153	50	227
	6	25	46	36	91	47	149	59	223
8	0	0	84	0	165	0	276	0	415
	2	12	57	16	109	25	178	28	263
	5	23	53	32	103	42	171	53	255
	8	28	49	39	98	51	164	64	247
10	0	0	88	0	175	0	295	0	447
	2	12	61	17	118	23	194	26	289
	5	23	57	32	113	41	187	52	280
	10	30	51	41	104	54	176	67	267
15	0	0	94	0	191	0	327	0	502
	2	11	69	15	136	20	226	22	339
	5	22	65	30	130	39	219	49	330
	10	29	59	40	121	51	206	64	315
	15	35	53	48	112	61	195	76	301
20	0	0	97	0	202	0	349	0	540
	2	10	75	14	149	18	250	20	377
	5	21	71	29	143	38	242	47	367
	10	28	64	38	133	50	229	62	351
	15	34	58	46	124	59	217	73	337
	20	48	52	55	116	69	206	84	322
30	0	0	100	0	213	0	374	0	587
	2	9	81	13	166	14	283	18	432
	5	21	77	28	160	36	275	45	421
	10	27	70	37	150	48	262	59	405
	15	33	64	44	141	57	249	70	389
	20	56	58	53	132	66	237	80	374
	30	NA	NA	73	113	88	214	104	346

**NOTE** - Single appliance venting configurations with zero lateral lengths are assumed to have no elbows in the vent system. For all other vent configurations, the vent system is assumed to have two 90° elbows. For each additional 90° elbow or equivalent (for example two 45° elbows equal one 90° elbow) beyond two, the maximum capacity listed in the venting table should be reduced by 10 percent (0.90 x maximum listed capacity).



**TABLE 4**

Vent Connector Capacity Type B Double-Wall Vents with Type B Double-Wall Connectors  
Serving Two or More Category I Appliances

Height H (feet)	Lateral L (feet)	Vent and Connector Diameter - D (inches)							
		3 inch		4 inch		5 inch		6 inch	
		Appliance Input Rating in Thousands of Btu Per Hour							
		Min	Max	Min	Max	Min	Max	Min	Max
6	1	22	37	35	66	46	106	58	164
	2	23	41	37	75	48	121	60	183
	3	24	44	38	81	49	132	62	199
8	1	22	40	35	72	49	114	64	176
	2	23	44	36	80	51	128	66	195
	3	24	47	37	87	53	139	67	210
10	1	22	43	34	78	49	123	65	189
	2	23	47	36	86	51	136	67	206
	3	24	50	37	92	52	146	69	220
15	1	21	50	33	89	47	142	64	220
	2	22	53	35	96	49	153	66	235
	3	24	55	36	102	51	163	68	248
20	1	21	54	33	99	46	157	62	246
	2	22	57	34	105	48	167	64	259
	3	23	60	35	110	50	176	66	271
30	1	20	62	31	113	45	181	60	288
	2	21	64	33	118	47	190	62	299
	3	22	66	34	123	48	198	64	309

**TABLE 5**

Common Vent Capacity Type B Double-Wall Vents with Type B Double-Wall Connectors  
Serving Two or More Category I Appliances

Vent Height H (feet)	Vent and Connector Diameter - D (inches)							
	4 inch		5 inch		7 inch		7 inch	
	Appliance Input Rating in Thousands of Btu Per Hour							
	FAN + FAN	FAN + NAT	FAN + FAN	FAN + NAT	FAN + FAN	FAN + NAT	FAN + FAN	FAN + NAT
6	92	81	140	116	204	161	309	248
8	101	90	155	129	224	178	339	275
10	110	97	169	141	243	194	367	299
15	125	112	195	164	283	228	427	352
20	136	123	215	183	314	255	475	394
30	152	138	244	210	361	297	547	459

### Removal of the Furnace from Common Vent

In the event that an existing furnace is removed from a venting system commonly run with separate gas appliances, the venting system is likely to be too large to properly vent the remaining attached appliances. Conduct the following test while each appliance is operating and the other appliances (which are not operating) remain connected to the common venting system. If the venting system has been installed improperly, you must correct the system as indicated in the general venting requirements section.

### WARNING

#### CARBON MONOXIDE POISONING HAZARD

Failure to follow the steps outlined below for each appliance connected to the venting system being placed into operation could result in carbon monoxide poisoning or death. The following steps shall be followed for each appliance connected to the venting system being placed into operation, while all other appliances connected to the venting system are not in operation:

- 1 - Seal any unused openings in the common venting system.
- 2 - Inspect the venting system for proper size and horizontal pitch. Determine that there is no blockage, restriction, leakage, corrosion, or other deficiencies which could cause an unsafe condition.
- 3 - Close all building doors and windows and all doors between the space in which the appliances remaining connected to the common venting system are located and other spaces of the building. Turn on clothes dryers and any appliances not connected to the common venting system. Turn on any exhaust fans, such as range hoods and bathroom exhausts, so they will operate at maximum speed. Do not operate a summer exhaust fan. Close fireplace dampers.
- 4 - Follow the lighting instructions. Turn on the appliance that is being inspected. Adjust the thermostat so that the appliance operates continuously.
- 5 - After the burner have operated for 5 minutes, test for leaks of flue gases at the draft hood relief opening. Use the flame of a match or candle.
- 6 - After determining that each appliance connected to the common venting system is venting properly, (step 3) return all doors, widows, exhaust fans, fireplace dampers, and any other gas-burning appliances to their previous mode of operation.
- 7 - If a venting problem is found during any of the preceding tests, the common venting system must be modified to correct the problem.

Resize the common venting system to the minimum vent pipe size determined by using the appropriate tables in Appendix G. (These are in the current standards of the National Fuel Gas Code ANSI Z223.1.

#### Gas Piping

Gas supply piping should not allow more than 0.5"W.C. drop in pressure between gas meter and unit. Supply gas pipe must not be smaller than unit gas connection.

### CAUTION

If a flexible gas connector is required or allowed by the authority that has jurisdiction, black iron pipe shall be installed at the gas valve and extend outside the furnace cabinet. The flexible connector can then be added between the black iron pipe and the gas supply line.

## Gas Supply

### WARNING

Do not over torque (800 in-lbs) or under torque (350 in-lbs) when attaching the gas piping to the gas valve.

- 1 - This unit is shipped standard for left or right side installation of gas piping (or top entry in horizontal applications). Connect the gas supply piping into the gas valve. The maximum torque is 800 in lbs and minimum torque is 350 in lbs when when attaching the gas piping to the gas valve.
- 2 - When connecting the gas supply piping, consider factors such as length of run, number of fittings, and furnace rating to avoid excessive pressure drop. TABLE 6 lists recommended pipe sizes for typical applications.
- 3 - The gas piping must not run in or through air ducts, clothes chutes, gas vents or chimneys, dumb waiters, or elevator shafts.
- 4 - The piping should be sloped 1/4 inch (6.4 mm) per 15 feet (4.57 m) upward toward the meter from the furnace. The piping must be supported at proper intervals [every 8 to 10 feet (2.44 to 3.01 m)] with suitable hangers or straps. Install a drip leg in vertical pipe runs to the unit.
- 5 - A 1/8" N.P.T. plugged tap or pressure post is located on the gas valve to facilitate test gauge connection. See FIGURE 25.
- 6 - In some localities, codes may require the installation of a manual main shut-off valve and union (furnished by the installer) external to the unit. The union must be of the ground joint type.

### IMPORTANT

Compounds used on threaded joints of gas piping must be resistant to the actions of liquified petroleum gases.

**NOTE** - If emergency shutoff is necessary, shut off the main manual gas valve and disconnect main power to the furnace. The installer should properly label these devices.

**TABLE 6**  
**Gas Pipe Capacity - ft<sup>3</sup>/hr (m<sup>3</sup>/hr)**

Nominal Iron Pipe Size Inches (mm)	Internal Diameter inches (mm)	Length of Pipe - feet (m)									
		10 (3.048)	20 (6.096)	30 (9.144)	40 (12.192)	50 (15.240)	60 (18.288)	70 (21.336)	80 (24.384)	90 (27.432)	100 (30.480)
1/2 (12.7)	.622 (17.799)	172 (4.87)	118 (3.34)	95 (2.69)	81 (2.29)	72 (2.03)	65 (1.84)	60 (1.69)	56 (1.58)	52 (1.47)	50 (1.42)
3/4 (19.05)	.824 (20.930)	360 (10.19)	247 (7.000)	199 (5.63)	170 (4.81)	151 (4.23)	137 (3.87)	126 (3.56)	117 (3.31)	110 (3.11)	104 (2.94)
1 (25.4)	1.049 (26.645)	678 (19.19)	466 (13.19)	374 (10.59)	320 (9.06)	284 (8.04)	257 (7.27)	237 (6.71)	220 (6.23)	207 (5.86)	195 (5.52)
1-1/4 (31.75)	1.380 (35.052)	1350 (38.22)	957 (27.09)	768 (22.25)	657 (18.60)	583 (16.50)	528 (14.95)	486 (13.76)	452 (12.79)	424 (12.00)	400 (11.33)
1-1/2 (38.1)	1.610 (40.894)	2090 (59.18)	1430 (40.49)	1150 (32.56)	985 (27.89)	873 (24.72)	791 (22.39)	728 (20.61)	677 (19.17)	635 (17.98)	600 (17.00)
2 (50.8)	2.067 (52.502)	4020 (113.83)	2760 (78.15)	2220 (62.86)	1900 (53.80)	1680 (47.57)	1520 (43.04)	1400 (39.64)	1300 (36.81)	1220 (34.55)	1160 (32.844)
2-1/2 (63.5)	2.469 (67.713)	6400 (181.22)	4400 (124.59)	3530 (99.95)	3020 (85.51)	2680 (75.88)	2480 (70.22)	2230 (63.14)	2080 (58.89)	1950 (55.22)	1840 (52.10)
3 (76.2)	3.068 (77.927)	11300 (319.98)	7780 (220.30)	6250 (176.98)	5350 (151.49)	4740 (134.22)	4290 (121.47)	3950 (111.85)	3670 (103.92)	3450 (97.69)	3260 (92.31)

**NOTE - Capacity given in cubic feet (m<sup>3</sup>) of gas per hour and based on 0.60 specific gravity gas.**

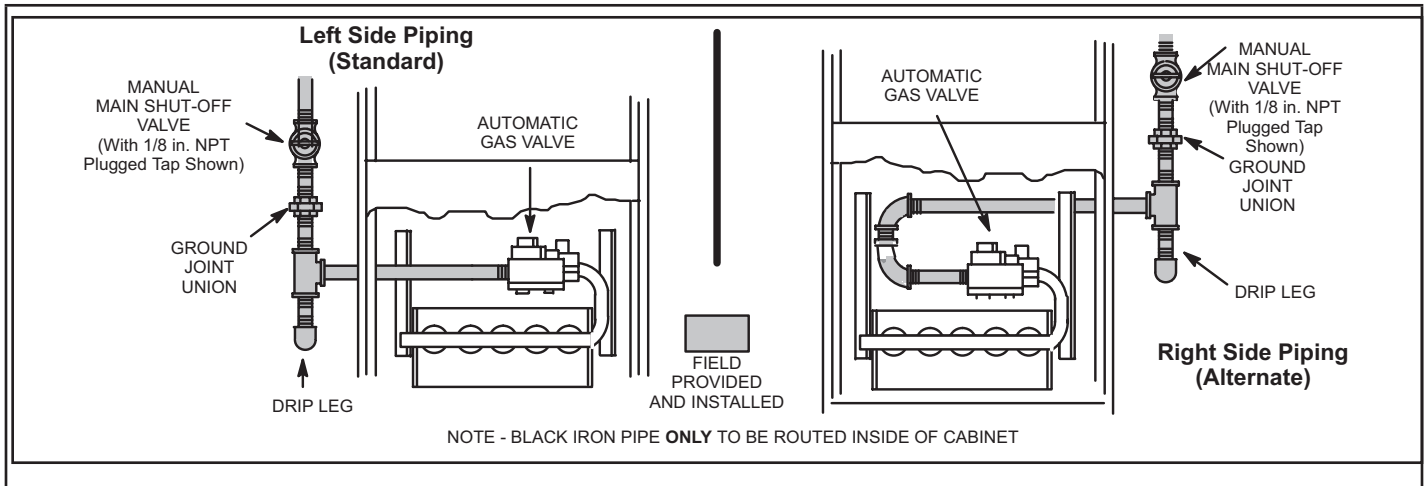

**FIGURE 18**

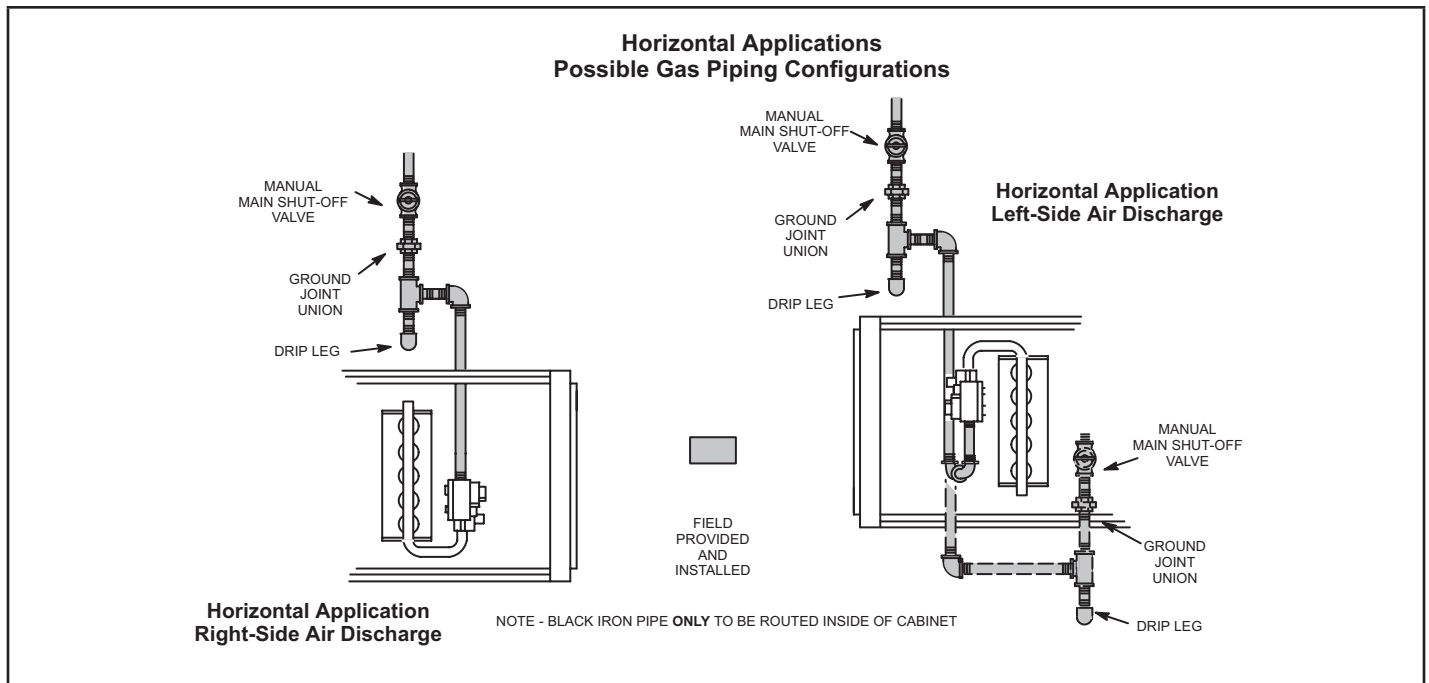

### Leak Check

After gas piping is completed, carefully check all piping connections (factory- and field-installed) for gas leaks. Use a leak detecting solution or other preferred means.

**NOTE** - If emergency shutoff is necessary, shut off the main manual gas valve and disconnect the main power to the furnace. The installer should properly label these devices.

## ⚠ CAUTION

Some soaps used for leak detection are corrosive to certain metals. Carefully rinse piping thoroughly after leak test has been completed. Do not use matches, candles, flame or other sources of ignition to check for gas leaks.

The furnace must be isolated by closing its individual manual shut-off valve and disconnecting from the gas supply system during any pressure testing of the gas supply system at pressures greater than 1/2 psig (3.48 kPa, 14 inches w.c.).

## ⚠ IMPORTANT

When testing pressure of gas lines, gas valve must be disconnected and isolated. See FIGURE 20. Gas valves can be damaged if subjected to pressures greater than 1/2 psig (3.48 kPa, 14 inches w.c.).

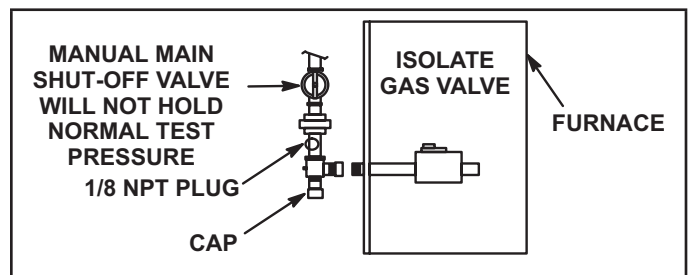

### Electrical

#### ELECTROSTATIC DISCHARGE (ESD)

##### Precautions and Procedures

## ⚠ CAUTION

Electrostatic discharge can affect electronic components. Take precautions to neutralize electrostatic charge by touching your hand and tools to metal prior to handling the control.

The unit is equipped with a field make-up box on the left hand side of the cabinet. The make-up box may be moved to the right side of the furnace to facilitate installation. If the make-up box is moved to the right side, clip the wire ties that bundle the wires together. The excess wire must be pulled into the blower compartment. Secure the excess wire to the existing harness to protect it from damage.

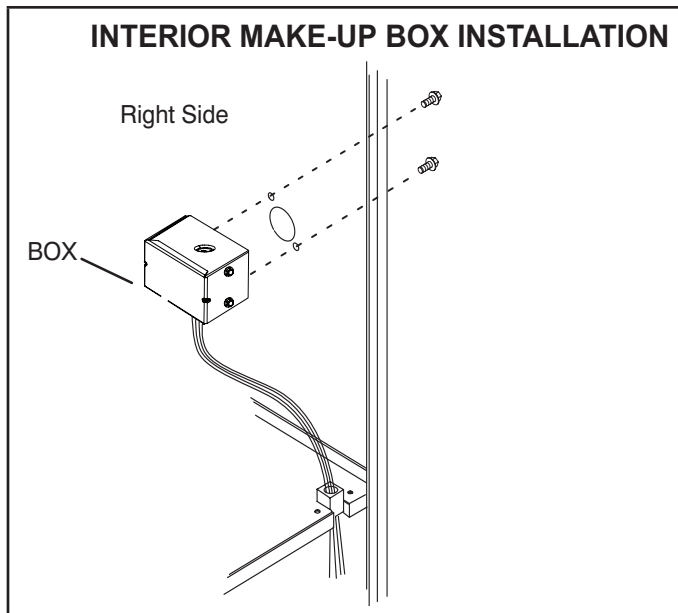

FIGURE 21

## ⚠ WARNING

Fire Hazard. Use of aluminum wire with this product may result in a fire, causing property damage, severe injury or death. Use copper wire only with this product.

Refer to FIGURE 22 for schematic wiring diagram, field wiring and trouble shooting.

The power supply wiring must meet Class I restrictions. Protected by either a fuse or circuit breaker, select circuit protection and wire size according to unit nameplate.

## ⚠ CAUTION

Failure to use properly sized wiring and circuit breaker may result in property damage. Size wiring and circuit breaker(s) per Product Specifications bulletin (EHB) and unit rating plate.

**NOTE** - Unit nameplate states maximum current draw. Maximum over-current protection allowed is 15 AMP.

Holes are on both sides of the furnace cabinet to facilitate wiring.

Install a separate (properly sized) disconnect switch near the furnace so that power can be turned off for servicing.

Before connecting the thermostat, check to make sure the wires will be long enough for servicing at a later date. Make sure that thermostat wire is long enough to facilitate future removal of blower for service.

Complete the wiring connections to the equipment. Use the provided unit wiring and field wiring diagram shown in FIGURE 22. Use 18-gauge wire or larger that is suitable for Class II rating for thermostat connections.

Electrically ground the unit according to local codes or, in the absence of local codes, according to the current National Electric Code (ANSI/NFPA No. 70). A green ground wire is provided in the field make-up box.

**NOTE** - The EL180UHNE furnace contains electronic components that are polarity sensitive. Make sure that the furnace is wired correctly and is properly grounded.

## ⚠ WARNING

Electric Shock Hazard. Can cause injury or death. Unit must be properly grounded in accordance with national and local codes.

### Accessory Terminals

One line voltage "EAC" 1/4" spade terminal is provided on the furnace integrated control. See FIGURE 24 for integrated control configuration. This terminal is energized when the indoor blower is operating. Any accessory rated up to one amp can be connected to this terminal with the neutral leg of the circuit being connected to one of the provided neutral terminals. If an accessory rated at greater than one amp is connected to this terminal, it is necessary to use an external relay.

One line voltage "HUM" 1/4" spade terminal is provided on the furnace integrated control. See FIGURE 24 for integrated control configuration. This terminal is energized in the heating mode when the combustion air inducer is operating. Any humidifier rated up to one amp can be connected to this terminal with the neutral leg of the circuit being connected to one of the provided neutral terminals. If a humidifier rated at greater than one amp is connected to this terminal, it is necessary to use an external relay.

One 24V "H" 1/4" spade terminal is provided on the furnace integrated control. See FIGURE 24 for integrated control configuration. The terminal is energized in the heating mode when the combustion air inducer is operating and the pressure switch is closed. Any humidifier rated up to 0.5 amp can be connected to this terminal with the ground leg of the circuit connected to ground or the "C" terminal.

### Generator Use - Voltage Requirements

The following requirements must be kept in mind when specifying a generator for use with this equipment:

- The furnace requires 120 volts + 10% (Range: 108 volts to 132 volts).
- The furnace operates at 60 Hz + 5% (Range: 57 Hz to 63 Hz).
- The furnace integrated control requires both polarity and proper ground. Both polarity and proper grounding should be checked before attempting to operate the furnace on either permanent or temporary power.
- Generator should have a wave form distortion of less than 5% total harmonic distortion.

## Thermostat

Install the room thermostat according to the instructions provided with the thermostat. See FIGURE 22 and or FIGURE 23 for thermostat designations. If the furnace is being matched with a heat pump, refer to the FM21 installation instruction or appropriate dual fuel thermostat instructions.

## Indoor Blower Speeds

- 1 - When the thermostat is set to "FAN ON," the indoor blower will run continuously on the fan speed when there is no cooling or heating demand. See TABLE 12 for allowable continuous circulation speeds.
- 2 - When the EL180UHNE is running in the heating mode, the indoor blower will run on the heating speed.
- 3 - When there is a cooling demand, the indoor blower will run on the cooling speed.

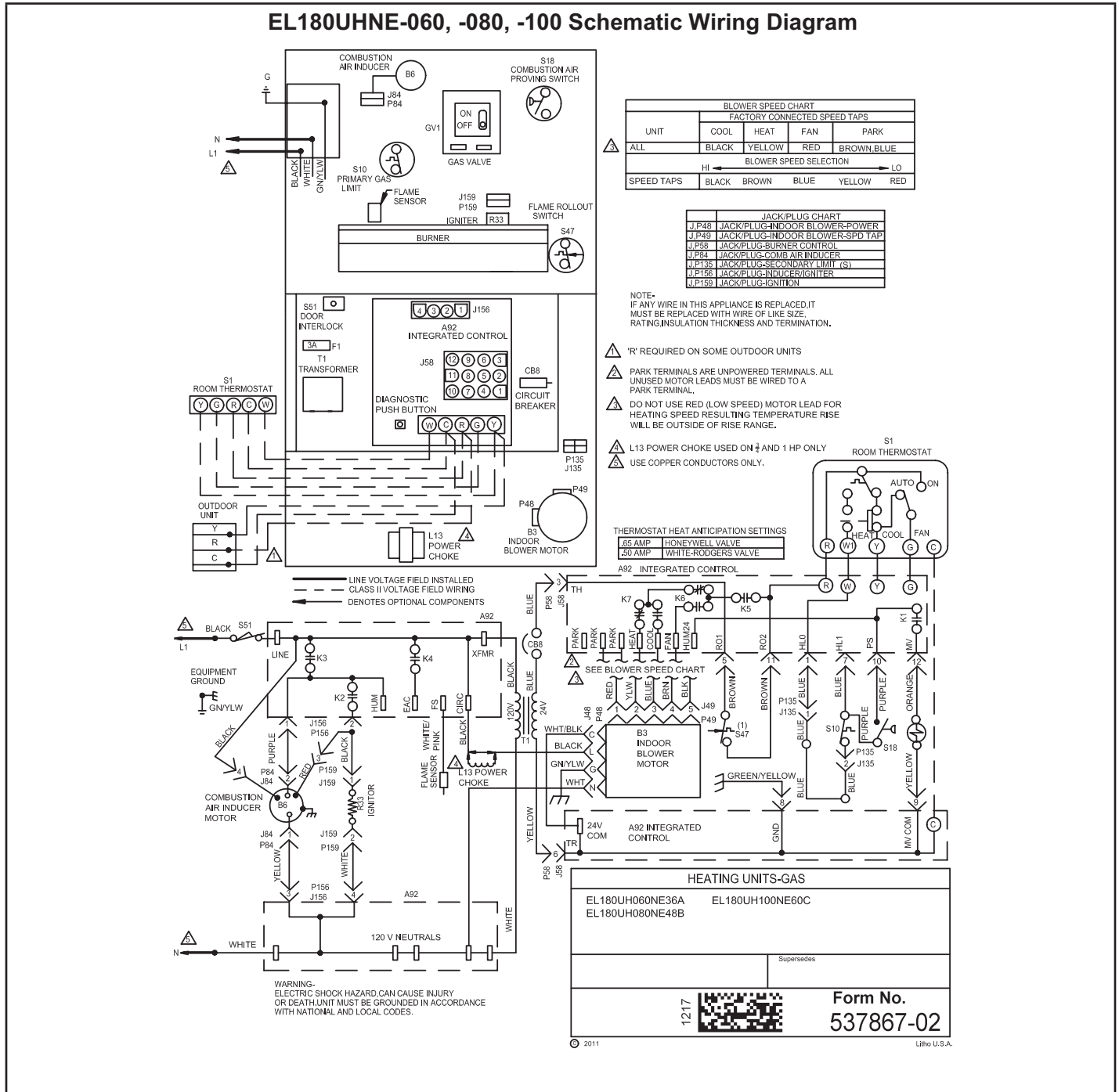

FIGURE 22

# EL180UHNE-040 Schematic Wiring Diagram

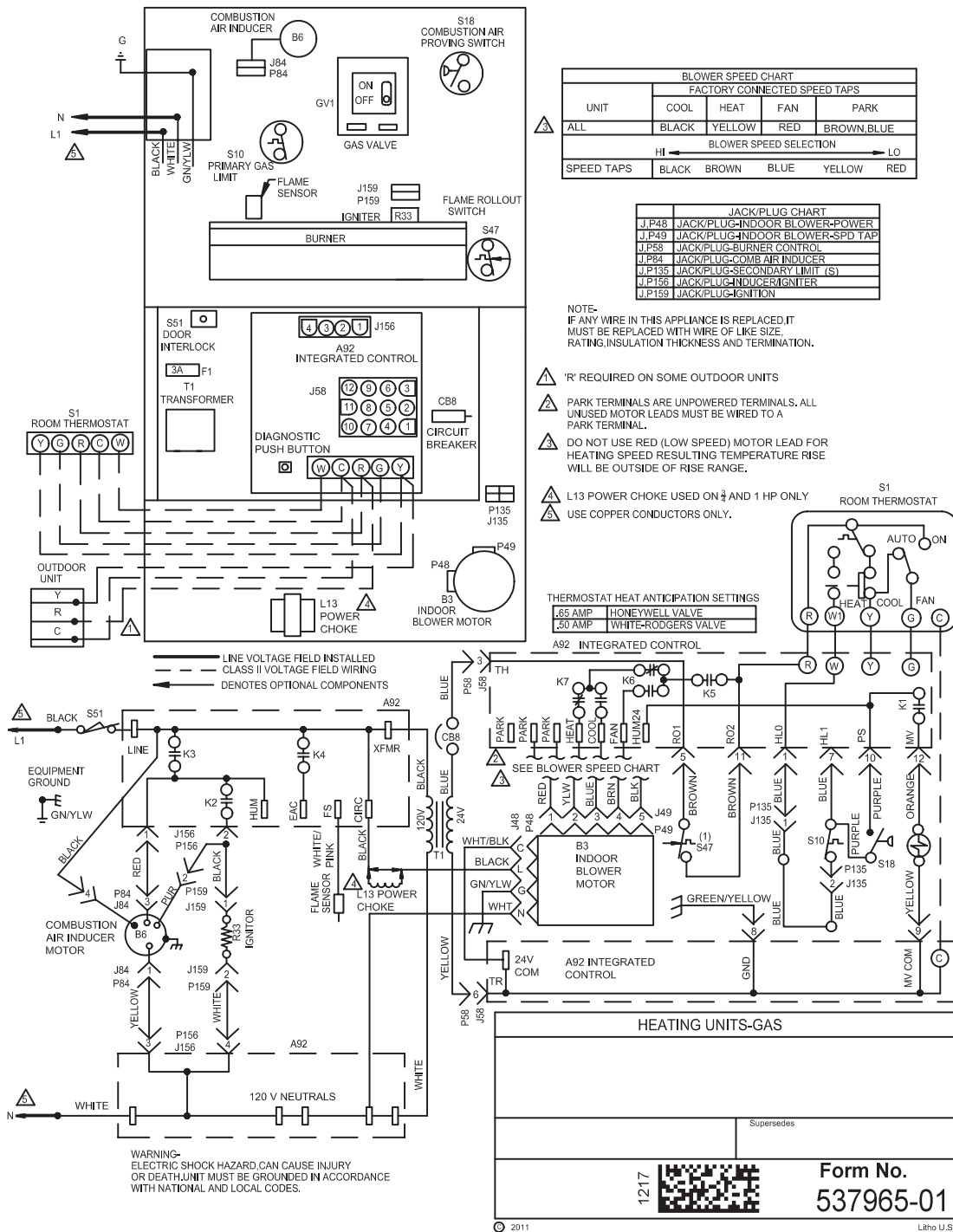

FIGURE 23

Integrated Control	
RED LED Flash Code <sup>2</sup>	Diagnostic Codes / Status of Furnace
Off	No power to control or board fault detected
Heartbeat <sup>1</sup>	Normal Operation - Idle, Continuous Fan, Cool
Continuous Rapid Flash	Call For Heat / Burner Operation
1	Reverse Line Voltage Polarity
2	Improper Earth Ground
3	Burner failed to light, or lost flame during heat demand
4	Low Flame Signal - check flame sensor
5	Watchguard - burner failed to light, exceeded maximum number of retries or recycles.
6	Not Used
7	Primary or Secondary Limit Open or Watchguard Mode - Limit Switch Open longer than 3 minutes
8	Rollout Switch Open
9	Pressure Switch failed to close or opened during heat demand
10	Watchguard - Pressure Switch opened 5 times during one heat demand
11	Pressure Switch stuck closed prior to activation of combustion air inducer
12	Flame Sensed without gas valve energized
13	Low Line Voltage
Notes	
Note - 1	A "Heartbeat" is indicated by a "Slow Flash" - 1 sec on 1 sec off, repeating
Note - 2	Error codes are indicated by a "rapid flash" - the LED flashes X times at 1/2 second on 1/2 second off, remains off for 3 seconds then repeats.
Note - 3	Last 10 error codes are stored in memory including when power is shut off to the unit. - To recall, press and release button, most recent will be displayed first, LED off for 3 sec, then next error code is displayed, etc. To clear error codes, depress and hold button longer than 5 seconds.

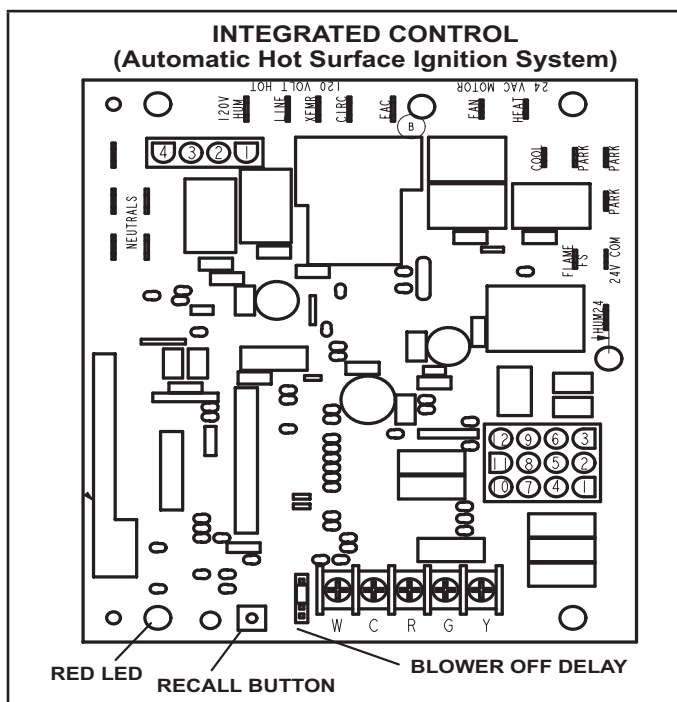

FIGURE 24

TABLE 7

1/4" QUICK CONNECT TERMINALS	
120HUM	Humidifier 120VAC
LINE	120VAC
XFMR	Transformer 120VAC
CIRC	Indoor blower 120VAC
EAC	Indoor air quality accessory 120VAC
NEUTRAL	Common 120VAC
HUM24	Humidifier 24VAC
3/16" QUICK CONNECT TERMINALS	
COOL	Cooling tap 24VAC
HEAT	Heating tap 24VAC
FAN	Continuous blower 24 VAC
PARK (no power)	Park terminal for speed taps
FLAME / FS	Flame Sense
24 COM	Common 24VAC



## Unit Start-Up

### **⚠ WARNING**

Do not use this furnace if any part has been underwater. A flood-damaged furnace is extremely dangerous. Attempts to use the furnace can result in fire or explosion. Immediately call a qualified service technician to inspect the furnace and to replace all gas controls, control system parts, and electrical parts that have been wet or to replace the furnace, if deemed necessary.

### **⚠ WARNING**

If overheating occurs or if gas supply fails to shut off, shut off the manual gas valve to the appliance before shutting off electrical supply.

### **⚠ WARNING**

Before attempting to perform any service or maintenance, turn the electrical power to unit OFF at disconnect switch.

**BEFORE LIGHTING** smell all around the appliance area for gas. Be sure to smell next to the floor because some gas is heavier than air and will settle on the floor.

The gas valve on the EL180UHNE unit is equipped with a gas control switch. Use only your hand to move the switch. Never use tools. If the switch will not turn or if the control switch will not move by hand, do not try to repair it.

#### **Placing the furnace into operation:**

EL180UHNE units are equipped with an automatic ignition system. Do not attempt to manually light burners on these furnaces. Each time the thermostat calls for heat, the burners will automatically light. The ignitor does not get hot when there is no call for heat on units with an automatic ignition system. The Honeywell gas valve is rated for ambient temperatures between -40° F and +175° F.

### **⚠ WARNING**

If you do not follow these instructions exactly, a fire or explosion may result causing property damage, personal injury or death.

#### **Gas Valve Operation (FIGURE 25)**

- 1 - STOP! Read the safety information at the beginning of this section.
- 2 - Set the thermostat to the lowest setting.
- 3 - Turn off all electrical power to the unit.
- 4 - This furnace is equipped with an ignition device which automatically lights the burners. Do not try to light the burners by hand.
- 5 - Remove the upper access panel.
- 6 - Move switch on gas valve to OFF. Do not force. See FIGURE 25.

- 7 - Wait five minutes to clear out any gas. If you then smell gas, STOP! Immediately call your gas supplier from a neighbor's phone. Follow the gas supplier's instructions. If you do not smell gas go to next step.

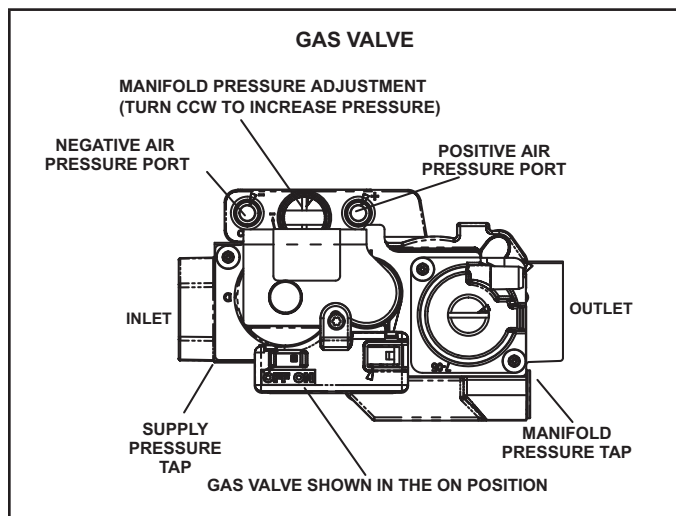

**FIGURE 25**

- 8 - Move switch on gas valve to ON. Do not force. See FIGURE 25.
- 9 - Replace the upper access panel.
- 10 - Turn on all electrical power to the unit.
- 11 - Set the thermostat to desired setting.  
**NOTE** - When unit is initially started, steps 1 through 11 may need to be repeated to purge air from gas line.
- 12 - If the appliance will not operate, follow the instructions "Turning Off Gas to Unit" and call your service technician or gas supplier.

#### **Turning Off Gas to Unit**

- 1 - Set the thermostat to the lowest setting.
- 2 - Turn off all electrical power to the unit if service is to be performed.
- 3 - Remove the upper access panel.
- 4 - Move switch on gas valve to OFF. Do not force.
- 5 - Replace the upper access panel.

#### **Failure To Operate**

If the unit fails to operate, check the following:

- 1 - Is the thermostat calling for heat?
- 2 - Are access panels securely in place?
- 3 - Is the main disconnect switch closed?
- 4 - Is there a blown fuse or tripped circuit breaker?
- 5 - Is the filter dirty or plugged? Dirty or plugged filters will cause the limit control to shut the unit off.
- 6 - Is gas turned on at the meter?
- 7 - Is the manual main shut-off valve open?
- 8 - Is the internal manual shut-off valve open?
- 9 - Is the unit ignition system in lock out? If the unit locks out again, call the service technician to inspect the unit for blockages.

- 10 - Is pressure switch closed? Obstructed flue will cause unit to shut off at pressure switch. Check flue and outlet for blockages.
- 11 - Are flame rollout switches tripped? If flame rollout switches are tripped, call the service technician for inspection.

**Heating Sequence Of Operation (follow steps below)**

- 1 - When thermostat calls for heat, combustion air blower starts.
- 2 - Combustion air pressure switch proves blower operation. Switch is factory-set and requires no adjustment.
- 3 - After a 15-second prepurge, the hot surface ignitor energizes.
- 4 - After a 20-second ignitor warm-up period, the gas valve solenoid opens. A 4-second trial for ignition period begins.
- 5 - Gas is ignited, flame sensor proves the flame, and the combustion process continues.
- 6 - If flame is not detected after first ignition trial, the ignition control will repeat steps 3 and 4 four more times before locking out the gas valve ("WATCHGUARD" flame failure mode). The ignition control will then automatically repeat steps 1 through 6 after 60 minutes.
- 7 - To interrupt the 60-minute "WATCHGUARD" period, move thermostat from "Heat" to "OFF" then back to "Heat." Heating sequence then restarts at step 1.

**Gas Pressure Adjustment**

**Gas Flow (Approximate)**

**TABLE 8**

GAS METER CLOCKING CHART				
Unit	Seconds for One Revolution			
	Natural		LP/Propane	
	1 cu ft Dial	2 cu ft Dial	1 cu ft Dial	2 cu ft Dial
-040	90	180	n/a	n/a
-060	60	120	150	300
-080	45	90	112	224
-100	36	72	n/a	n/a
Natural-1000 btu/cu ft LP/Propane - 2500 btu/cu ft				

Furnace should operate at least 5 minutes before checking gas flow. Determine time in seconds for two revolutions of gas through the meter. (Two revolutions assures a more accurate time.) Divide by two and compare to time in TABLE 8. Remove temporary gas meter if installed.

**NOTE** - To obtain accurate reading, shut off all other gas appliances connected to meter.

**Supply Pressure Measurement**

On multiple unit installations, each unit should be checked separately, with and without units operating. Supply pressure must fall within range listed in TABLE 9.

**Check Manifold Pressure**

- 1 - Remove the threaded plug from the outlet side of the gas valve and install a field-provided barbed fitting. Connect measuring device "+" connection to barbed fitting to measure manifold pressure.  
Start unit and allow 5 minutes for unit to reach steady state.
- 2 - After allowing unit to stabilize for 5 minutes, record manifold pressure and compare to value given in TABLE 9. Make manifold adjustment if necessary
- 3 - Shut unit off and remove manometer as soon as an accurate reading has been obtained.
- 4 - Restart unit and check for any gas leaks. Seal any leaks if found.

**⚠ IMPORTANT**

For safety, connect a shut-off valve between the manometer and the gas tap to permit shut off of gas pressure to the manometer.

**TABLE 9**

**Supply Line and Manifold Pressure (inches w.c.)**

Unit	Fue	Manifold Pressure	Line Pressure
All	Nat	3.2 - 3.6	4.5 - 10.5
-060, -080	LP	3.2 - 3.6	13.0

**Proper Combustion**

Furnace should operate minimum 15 minutes with correct manifold pressure and gas flow rate before checking combustion. Take combustion sample beyond the flue outlet and compare to the table below.

**TABLE 10**

Unit	CO <sub>2</sub> % Nat	CO <sub>2</sub> % LP	LP Conversion Kit
-040	6.5 - 7.5	N/A	N/A
-060		7.5 - 9.0	20P40
-080		7.5 - 9.0	20P41
-100		N/A	N/A

**High Altitude Information**

Units are **NOT** approved for installations over 4500 ft.

## Other Unit Adjustments

### Primary Limit

The primary limit is located on the heating compartment vestibule panel. The secondary limits (if equipped) are located in the blower compartment, attached to the back side of the blower. These auto reset limits are factory-set and require no adjustment.

### Thermal Switch

These manually reset switches are located on the front of the box.

### Pressure Switch

The pressure switch is located in the heating compartment adjacent to the combustion air inducer. The switch checks for proper combustion air inducer operation before allowing ignition trial. The switch is factory-set and requires no adjustment.

### Temperature Rise

After the furnace has been started, and supply and return air temperatures have been allowed to stabilize, check the temperature rise. If necessary, adjust the blower speed to maintain the temperature rise within the range shown on the unit nameplate. See TABLE 11 for allowable heating speeds. Increase the blower speed to decrease the temperature. Decrease the blower speed to increase the temperature rise. Failure to adjust the temperature rise may cause erratic limit operation.

### Fan Control

The heat fan-on time of 30 seconds is not adjustable. The heat fan-off delay (amount of time that the blower operates after the heat demand has been satisfied) may be adjusted by changing the jumper position across the five pins on the integrated control. The unit is shipped with a factory fan-off delay setting of 90 seconds. The fan-off delay affects comfort and is adjustable to satisfy individual applications. Adjust the fan-off delay to achieve a supply air temperature between 90° and 110°F at the moment that the blower is de-energized. Longer off delay settings provide lower return air temperatures; shorter settings provide higher return air temperatures. See FIGURE 26.

### Constant Torque Motor

EL180UHNE units are equipped with a constant torque ECM motor. It has a DC motor coupled to an electronic control module both contained in the same motor housing. The motor is programmed to provide constant torque at each of the five selectable speeds. The motor has five speed taps. Each tap requires 24 volts to energize.

## HEAT FAN-OFF TIME IN SECONDS

JUMPER POSITION		HEAT OFF DELAY
PIN1	PIN2	60
PIN2	PIN3	90
PIN3	PIN4	120
PIN4	PIN5	180
NO JUMPER		180

To adjust fan-off timing, reposition jumper across pins to achieve desired setting.

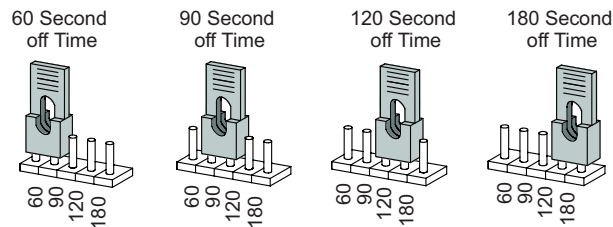

FIGURE 26

### Input Voltage Requirements

The circuit is designed to be operated with AC voltage. A voltage of 12 to 33VAC is required to energize the motor. Expected current draw will be less than 20mA.

### Blower Speeds

Follow the steps below to change the blower speeds.

- 1 - Turn off electrical power to furnace.
- 2 - Remove blower access panel.
- 3 - Disconnect existing speed tap at integrated control speed terminal.

**NOTE** - Termination of any unused motor leads must be insulated.

- 4 - Place unused blower speed tap on integrated control "PARK" terminal or insulate.
- 5 - Refer to blower speed selection chart on unit wiring diagram for desired heating or cooling speed. See Product Specifications manual for blower performance data. See TABLE 11 for allowable heating speeds.
- 6 - Connect selected speed tap at integrated control speed terminal.
- 7 - Resecure blower access panel.
- 8 - Turn on electrical power to furnace.
- 9 - Recheck temperature rise.

### Electronic Ignition

The integrated control has an added feature of an internal Watchguard control. The feature serves as an automatic reset device for integrated control lockout caused by ignition failure. This type of lockout is usually due to low gas line pressure. After one hour of continuous thermostat demand for heat, the Watchguard will re-set and remake thermostat demand to the furnace and automatically reset the integrated control to begin the ignition sequence.

## Service

### **WARNING**

**ELECTRICAL SHOCK, FIRE,  
OR EXPLOSION HAZARD.**

Failure to follow safety warnings exactly could result in dangerous operation, serious injury, death or property damage.

Improper servicing could result in dangerous operation, serious injury, death, or property damage.

Before servicing, disconnect all electrical power to furnace.

When servicing controls, label all wires prior to disconnecting. Take care to reconnect wires correctly.

Verify proper operation after servicing.

### **WARNING**

The blower access panel must be securely in place when the blower and burners are operating. Gas fumes, which could contain carbon monoxide, can be drawn into living space resulting in personal injury or death.

## Annual Furnace Maintenance

At the beginning of each heating season, and to comply with the Lennox Limited Warranty, your system should be checked by a licensed professional technician (or equivalent) as follows:

**NOTE** - *Burner inspection and service is not recommended for annual furnace maintenance.*

- 1 - Check wiring for loose connections, voltage at indoor unit and amperage of indoor motor.
- 2 - Inspect all gas pipe and connections for leaks.
- 3 - Check the cleanliness of filters and change if necessary (monthly).
- 4 - Check the cleanliness of blower assembly and clean the housing, blower wheel and blower motor if necessary.
- 5 - Inspect the combustion air inducer and clean if necessary.
- 6 - Evaluate the heat exchanger integrity by inspecting the heat exchanger per the AHRI heat exchanger inspection procedure. This procedure can be viewed at [www.ahrinet.org](http://www.ahrinet.org). See "Induced-draft Furnace Heat Exchanger Inspection Procedure".

7- Ensure sufficient combustion air is available to the furnace. Fresh air grilles and louvers (on the unit and in the room where the furnace is installed) must be properly sized, open and unobstructed to provide combustion air.

8- Inspect the furnace venting system to make sure it is in place, structurally sound, and without holes, corrosion, or blockage. Vent system must be free and clear of obstructions and must slope upward away from the furnace. Vent system should be installed per the National Fuel Gas Code

9- Inspect the furnace return air duct connection to ensure the duct is sealed to the furnace. Check for air leaks on supply and return ducts and seal where necessary.

10- Check the condition of the furnace cabinet insulation and repair if necessary.

11- Perform a complete combustion analysis during the furnace inspection to ensure proper combustion and operation. Consult Service Literature for proper combustion values.

12- Verify operation of smoke detectors and CO detectors and replace batteries as required.

Perform a general system test. Turn on the furnace to check operating functions such as the start-up and shut-off operation.

1 - Check the operation of the ignition system, inspect and clean flame sensor. Check microamps before and after. Check controls and safety devices (gas valve, flame sensor, temperature limits). Consult Service Manual for proper operating range. Thermal Limits should be checked by restricting airflow and not disconnecting the indoor blower. For additional details, please see Service and Application Note H049.

2 - Verify that system total static pressure and airflow settings are within specific operating parameters.

3 - Clock gas meter to ensure that the unit is operating at the specified firing rate. Check the supply pressure and the manifold pressure. **If manifold pressure adjustment is necessary, consult the Service Literature for unit specific information on adjusting gas pressure. Not all gas valves are adjustable.** Verify correct temperature rise.

## Repair Parts List

The following repair parts are available through independent Lennox dealers. When ordering parts, include the complete furnace model number listed on the CSA International nameplate -- Example: EL180UH040NE36A-01. **All service must be performed by a licensed professional installer (or equivalent), service agency, or gas supplier.**

### Cabinet Parts

- Access panel
- Blower panel
- Top cap

### Control Panel Parts

- Transformer
- Integrated control
- Door interlock switch
- Circuit breaker

### Blower Parts

- Blower wheel
- Blower housing
- Motor
- Motor mounting frame
- Motor power choke
- Blower housing cutoff plate

### Heating Parts

- Flame sensor
- Heat exchanger assembly
- Gas manifold
- Combustion air inducer
- Gas valve
- Main burner
- Main burner orifice
- Pressure switch
- Ignitor
- Primary limit control
- Rollout switch

**Start-Up & Performance Check list**

**UNIT SET UP  
(typical)**

Unit Model Number \_\_\_\_\_

Serial Number \_\_\_\_\_

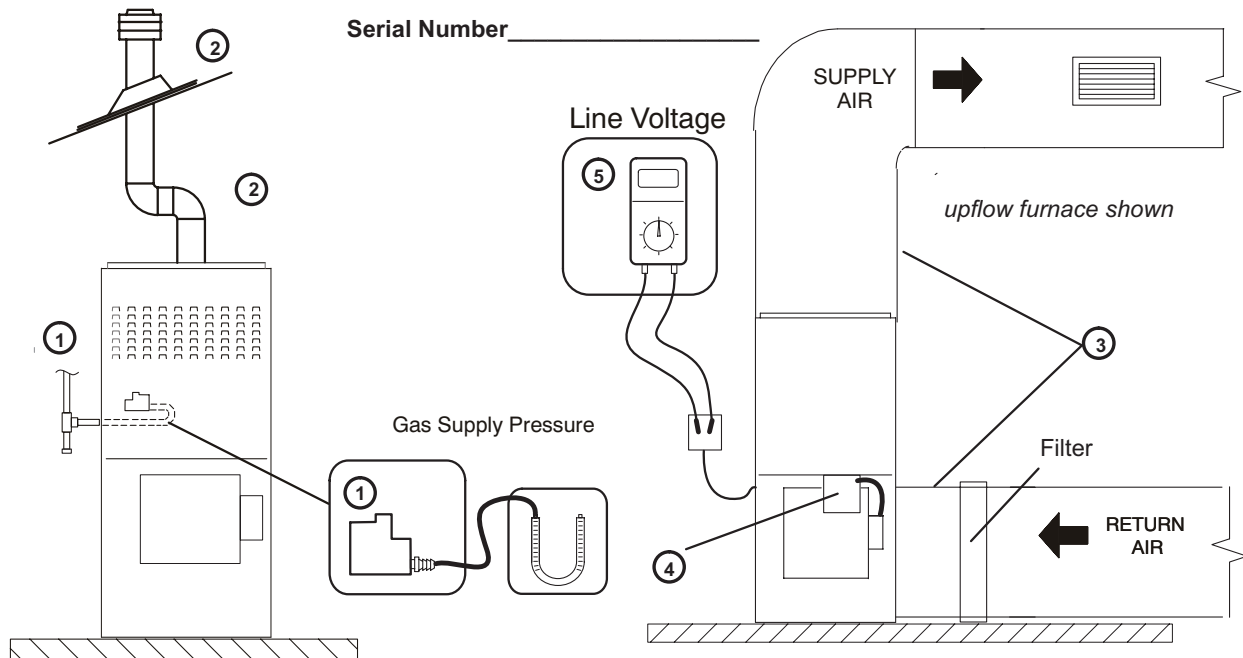

**① GAS SUPPLY**

- Natural Gas     LP/Propane Gas
- Piping Connections Tight
- Leak Tested
- Supply Line Pressure " W.C. \_\_\_\_\_

**② VENT / EXHAUST PIPE**

- Secure to Unit
- Elbows Secured to Pipe
- Roof Flashing (water tight)
- Vent Pipe Supported

**③ DUCT SYSTEM**

**SUPPLY AIR DUCT**

- Sealed
- Insulated (if necessary)
- Registers Open and Unobstructed

**RETURN DUCT**

- Sealed
- Filter Installed and Clean
- Grilles Unobstructed

**④ INTEGRATED CONTROL**

- DIP Switches Set (if applicable)
- Appropriate Links in Place (if applicable)

**⑤ VOLTAGE CHECK**

Supply Voltage \_\_\_\_\_

- Electrical Connections Tight

**UNIT OPERATION  
(typical)**

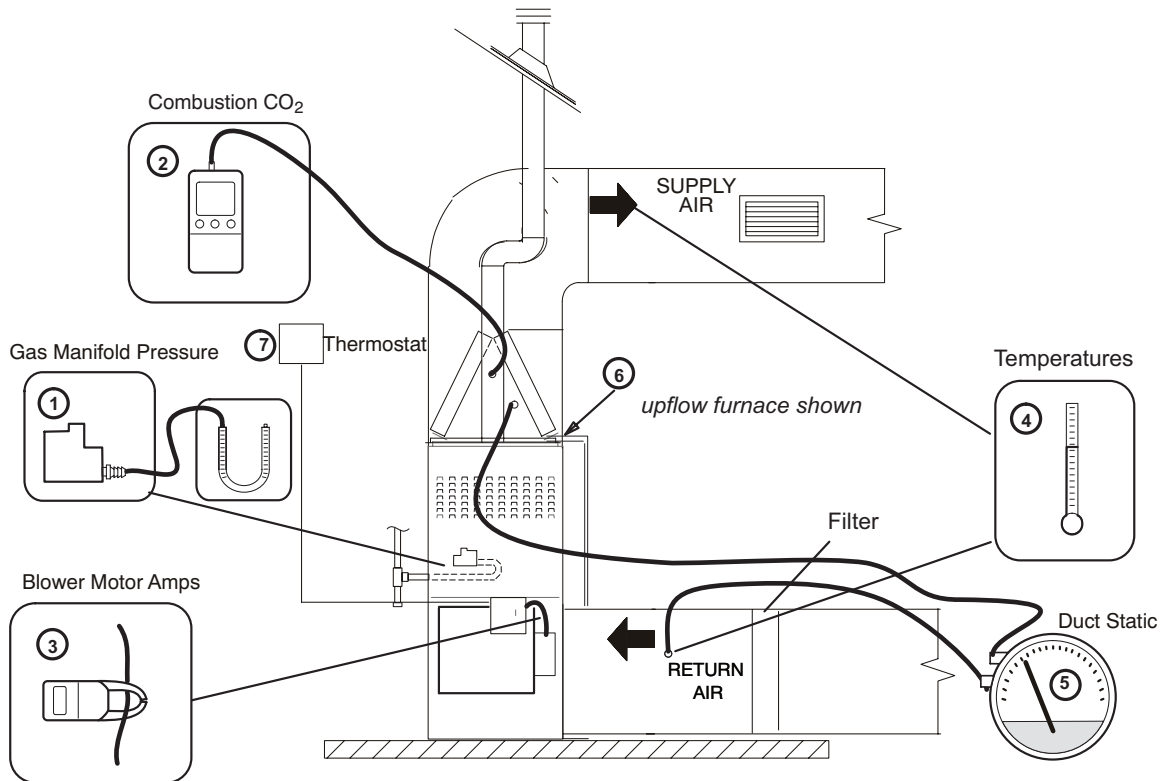

**HEATING MODE**

- ① GAS MANIFOLD PRESSURE "W.C. \_\_\_\_\_
- ② COMBUSTION SAMPLE CO<sub>2</sub>% \_\_\_\_\_ CO PPM \_\_\_\_\_
- ③ INDOOR BLOWER AMPS \_\_\_\_\_
- ④ TEMPERATURE RISE  
 Supply Duct Temperature \_\_\_\_\_  
 Return Duct Temperature - \_\_\_\_\_  
 Temperature Rise = \_\_\_\_\_
- ⑤ TOTAL EXTERNAL STATIC (dry coil)  
 Supply External Static \_\_\_\_\_  
 Return External Static + \_\_\_\_\_  
 Total External Static = \_\_\_\_\_

**COOLING MODE**

- ③ INDOOR BLOWER AMPS \_\_\_\_\_
- ④ TEMPERATURE DROP  
 Return Duct Temperature \_\_\_\_\_  
 Supply Duct Temperature - \_\_\_\_\_  
 Temperature Drop = \_\_\_\_\_
- ⑤ TOTAL EXTERNAL STATIC (dry coil)  
 Supply External Static \_\_\_\_\_  
 Return External Static + \_\_\_\_\_  
 Total External Static = \_\_\_\_\_
- ⑥ DRAIN LINE  
 Leak Free
- ⑦ THERMOSTAT  
 Adjusted and Programmed  
 Operation Explained to Owner

Contractor's Name \_\_\_\_\_ Telephone \_\_\_\_\_ Checklist Completed \_\_\_\_\_

Job Address \_\_\_\_\_ - \_\_\_\_\_ Technician's Name \_\_\_\_\_

**TABLE 11**

<b>Allowable Heating Speeds</b>					
<b>Model Number</b>	<b>Red</b>	<b>Yellow</b>	<b>Blue</b>	<b>Brown</b>	<b>Black</b>
EL180UH040NE36A	Not Allowed	Factory Setting	Allowed	Allowed	Not Allowed
EL180UH060NE36A		Allowed	Factory		Allowed
EL180UH080NE48C					Allowed
EL180UH100NE60C					Not Allowed

**TABLE 12**

<b>Allowable Circulation Speeds</b>					
<b>Model Number</b>	<b>Red</b>	<b>Yellow</b>	<b>Blue</b>	<b>Brown</b>	<b>Black</b>
All Models	Factory Setting	Not Allowed	Not Allowed	Not Allowed	Not Allowed



EL180UH040NE36A PERFORMANCE (Less Filter)

External Static Pressure in. w.g.	Air Volume / Watts at Various Blower Speeds									
	High		Medium-High		Medium		Medium-Low		Low	
	cfm	Watts	cfm	Watts	cfm	Watts	cfm	Watts	cfm	Watts
0.00	1430	243	1200	140	1025	86	945	66	945	45
0.10	1395	253	1165	151	1005	99	940	75	930	50
0.20	1370	264	1130	157	930	99	825	80	795	68
0.30	1345	278	1100	170	895	110	775	85	650	63
0.40	1320	289	1085	182	875	120	745	90	615	70
0.50	1295	302	1035	189	820	126	705	102	545	76
0.60	1245	308	1010	200	795	135	655	107	515	85
0.70	1220	320	980	210	755	147	615	115	445	87
0.80	1200	332	930	215	700	152	570	121	400	95

EL180UH060NE36A PERFORMANCE (Less Filter)

External Static Pressure in. w.g.	Air Volume / Watts at Various Blower Speeds									
	High		Medium-High		Medium		Medium-Low		Low	
	cfm	Watts	cfm	Watts	cfm	Watts	cfm	Watts	cfm	Watts
0.00	1410	243	1190	141	1030	86	930	73	835	55
0.10	1380	251	1165	150	990	95	890	89	790	65
0.20	1360	264	1115	158	950	99	840	78	730	68
0.30	1315	278	1090	171	910	110	790	89	660	61
0.40	1295	290	1070	182	865	122	740	93	600	71
0.50	1270	300	1025	191	825	127	695	103	545	75
0.60	1235	300	1000	197	785	136	650	108	495	84
0.70	1215	317	975	208	750	147	615	118	450	88
0.80	1185	331	920	216	700	153	555	121	390	96

EL180UH080NE48B PERFORMANCE (Less Filter)

External Static Pressure in. w.g.	Air Volume / Watts at Various Blower Speeds									
	High		Medium-High		Medium		Medium-Low		Low	
	cfm	Watts	cfm	Watts	cfm	Watts	cfm	Watts	cfm	Watts
0.00	1785	344	1570	236	1455	183	1390	161	1230	116
0.10	1745	360	1535	249	1420	194	1360	172	1190	129
0.20	1725	373	1500	266	1375	212	1310	189	1145	135
0.30	1695	386	1475	279	1340	224	1280	201	1100	146
0.40	1665	405	1440	293	1305	237	1235	208	1065	156
0.50	1640	418	1410	307	1275	250	1190	223	1015	170
0.60	1595	433	1370	323	1235	263	1160	234	970	182
0.70	1570	446	1330	336	1190	277	1120	249	930	187
0.80	1530	461	1300	349	1155	289	1095	260	900	201

EL180UH100NE60C (Less Filter)

External Static Pressure in. w.g.		Air Volume / Watts at Different Blower Speeds																			
		Bottom Return Air, Side Return Air with Return Air from Both Sides or Return Air from Bottom and One Side.										<b>Single Side Return Air</b> – Air volumes in <b>bold</b> require Optional Return Air Base <u>and</u> field fabricated transition to accommodate 20 x 25 x 1 in. air filter in order to maintain proper air velocity.									
		High		Med-High		Medium		Med-Low		Low		High		Med-High		Medium		Med-Low		Low	
cfm	Watts	cfm	Watts	cfm	Watts	cfm	Watts	cfm	Watts	cfm	Watts	cfm	Watts	cfm	Watts	cfm	Watts	cfm	Watts	cfm	Watts
0.00	2205	623	1950	415	1710	275	1575	220	1425	160	2235	595	1945	382	1725	262	1590	202	1430	165	
0.10	2175	639	1910	427	1685	287	1545	234	1400	176	2205	611	1915	397	1695	280	1550	218	1400	193	
0.20	2145	658	1885	449	1635	309	1490	246	1325	181	2165	629	1885	424	1660	293	1510	235	1335	175	
0.30	2100	681	1845	466	1605	327	1465	259	1275	196	2135	652	1850	441	1615	312	1475	247	1275	182	
0.40	2095	700	1815	481	1565	337	1415	280	1225	204	2085	676	1800	456	1580	330	1430	261	1240	197	
0.50	2045	717	1780	499	1525	356	1375	286	1195	218	2055	685	1775	474	1535	347	1395	281	1195	206	
0.60	2025	737	1735	516	1500	374	1350	304	1145	230	2025	700	1755	494	1505	359	1355	300	1155	222	
0.70	1995	746	1715	533	1465	389	1320	323	1090	248	1990	720	1725	515	1480	377	1310	308	1120	237	
0.80	1950	769	1675	547	1430	401	1255	331	1065	259	1965	742	1685	532	1445	396	1275	325	1060	248	