



13ACXN
MERIT® Series
R-410A - 60 Hz

**RESIDENTIAL
PRODUCT SPECIFICATIONS**

Bulletin No. 210831
June 2020
Supersedes May 2010



**MERIT®
SERIES**

SEER up to 15.50
1.5 to 5 Tons
Cooling Capacity - 17,500 to 59,000 Btuh

MODEL NUMBER IDENTIFICATION

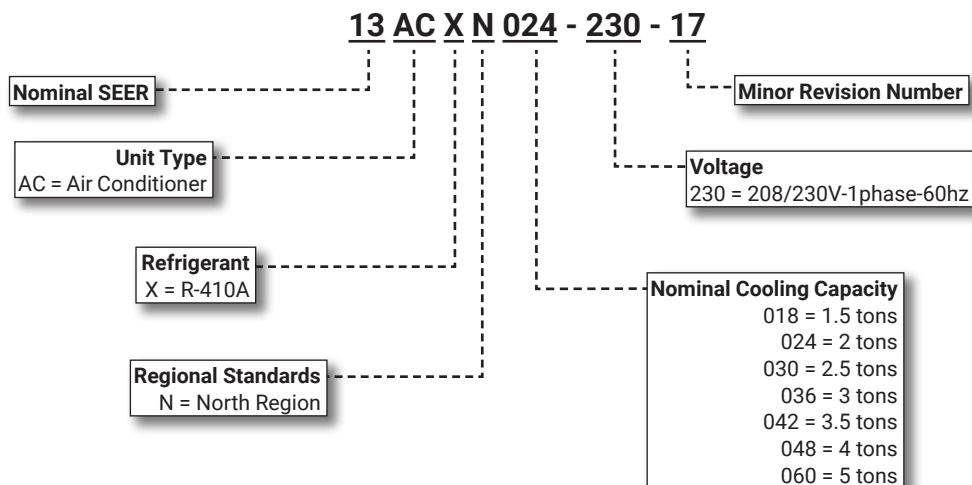

FEATURES HIGHLIGHTS

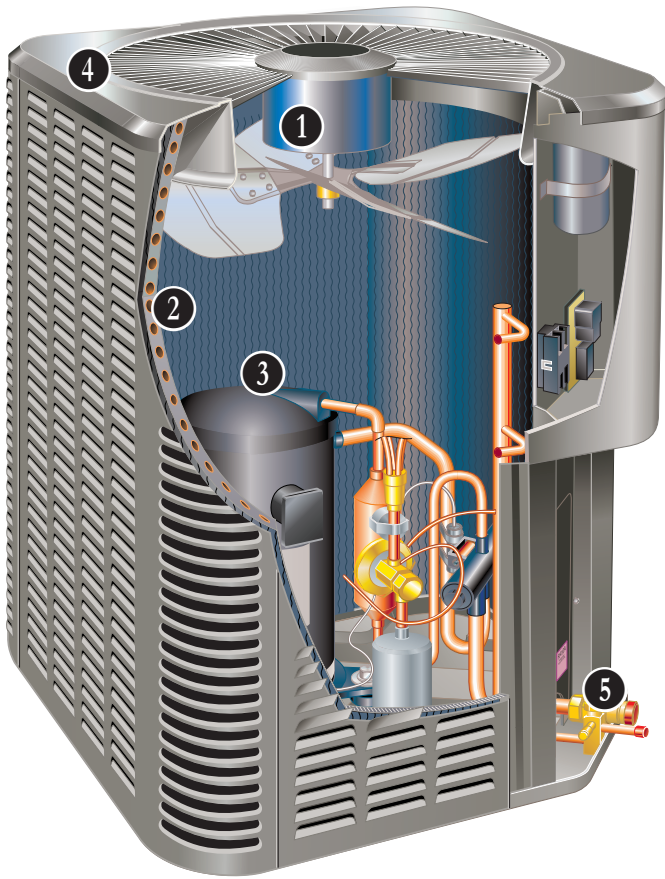

1. Condenser Fan
2. Copper Tube/Enhanced Fin Coil
3. Scroll Compressor
4. Heavy Gauge Steel Cabinet
5. Refrigerant Line Access

CONTENTS

Approvals And Warranty	3
Contents	2
Controls - Order Separately	7
Dimensions - Unit	8
Electrical Data	7
Features	3
Field Wiring	9
Installation Clearance.	9
Model Number Identification.	1
Optional Accessories - Order Separately	7
Sound Data	9
Specifications	7
TXV/Orifice Usage	10

APPROVALS AND WARRANTY

APPROVALS

- AHRI Standard 210/240 certified
- AHRI Certified system match-ups and expanded ratings, visit www.LennoxPros.com
- Sound rated to AHRI Standard 270-2008 test conditions
- Tested in the Lennox Research Laboratory environmental test room
- Rated according to U.S. Department of Energy (DOE) test procedures
- Region specific models meet the minimum efficiency requirements for U.S DOE Federal Regional Standards in that area.
- Unit and components ETL, NEC and CEC bonded for grounding to meet safety standards for servicing
- ETL certified (U.S. and Canada)
- ISO 9001 Registered Manufacturing Quality System

WARRANTY

- Compressor:
 - Limited five years in residential installations
 - Limited five years in non-residential installations
- All other covered components:
 - Limited five years in residential installations
 - Limited one year in non-residential installations

NOTE - Refer to Lennox Equipment Limited Warranty certificate included with unit for specific details.

FEATURES

APPLICATIONS

- 1.5 through 5 tons
- Single phase power supply
- Sound levels as low as 76 dBA
- Vertical air discharge
- Applicable to indoor air handlers or gas furnaces with indoor add-on coils
- Shipped completely factory assembled, piped and wired

NOTE - Installer must set outdoor unit, connect refrigerant lines and make electrical connections to complete job.

REFRIGERATION SYSTEM

R-410A Refrigerant

- Non-chlorine, ozone friendly
- Unit is factory pre-charged

NOTE - Total system refrigerant charge is dependant on outdoor unit size, indoor unit size and refrigerant line length.

NOTE - Refer to the unit-mounted charging sticker to determine correct amount of charge required.

2 Copper Tube/Enhanced Fin Coil

- Lennox designed and fabricated coil
- Ripple-edged aluminum fins
- Copper tube construction
- Lanced fins for maximum fin surface exposure
- Fin collars grip tubing for maximum contact area
- Flared shoulder tubing connections
- Silver soldering construction
- Coil is factory tested under high pressure
- Steel louvered panels provide complete coil protection
- Panels can be completely removed for servicing

High Capacity Liquid Line Drier

- Furnished with unit for field installation
- Drier traps moisture or dirt
- 100% molecular-sieve, bead type, bi-flow drier

High Pressure Switch

- Shuts off unit if abnormal operating conditions cause the discharge pressure to rise above setting
- Automatic reset

1 Outdoor Coil Fan

- Direct drive fan
- Vertical air discharge
- Louvered steel top fan guard
- Totally enclosed fan motor
- Ball bearings
- Inherently protected

FEATURES

REFRIGERATION SYSTEM (continued)

Refrigerant Flow Control

- Units applicable to expansion valve systems or RFC systems when matched with specific indoor coils

RFCIV:

- Accurately meters refrigerant in system
- Refrigerant control is accomplished by exact sizing of refrigerant metering orifice
- The principle involves matching indoor coil with proper bore size of orifice in metering device
- Equalizes pressure shortly after compressor stops, unit starts unloaded, eliminating need for additional controls

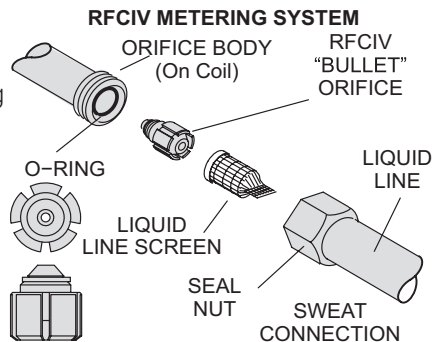

Optional Accessories

Expansion Valve Kits

- Field installed on certain indoor units
- See TXV Usage Table
- Chatleff-style fittings

Freezestat

- Senses suction line temperature
- Cycles compressor off when suction line temperature falls below its setpoint
- Opens at 29°F and closes at 58°F
- Installs on or near the discharge line of the evaporator or on the suction line

Loss of Charge Switch Kit

- Protects the compressor from damage due to low refrigerant charge conditions
- SPST, normally-closed switch
- Automatic reset switch
- Mounted on liquid line

Refrigerant Line Kits

- Refrigerant lines are shipped refrigeration clean
- Lines are cleaned, dried, pressurized and sealed at factory
- Suction line fully insulated
- Lines are stubbed at both ends

COMPRESSOR

3 Scroll Compressor

- High efficiency with uniform suction flow
- Constant discharge flow, high volumetric efficiency and quiet operation
- Low gas pulses during compression reduces operational sound levels
- Compressor motor is internally protected from excessive current and temperature
- Muffler in discharge line reduces operating sound levels
- Compressor is installed in the unit on resilient rubber mounts for vibration free operation



Scroll Compressor Operation

- Two involute spiral scrolls matched together generate a series of crescent-shaped gas pockets between them
- During compression, one scroll remains stationary while the other scroll orbits around it
- Gas is drawn into the outer pocket, the pocket is sealed as the scroll rotates
- As the spiral movement continues, gas pockets are pushed to the center of the scrolls. Volume between the pockets is simultaneously reduced
- When the pocket reaches the center, gas is now at high pressure and is forced out of a port located in the center of the fixed scrolls
- During compression, several pockets are compressed simultaneously resulting in a smooth continuous compression cycle
- Continuous flank contact, maintained by centrifugal force, minimizes gas leakage and maximizes efficiency
- Compressor is tolerant to the effects of slugging and contaminants. If this occurs, scrolls separate, allowing liquid or contaminants to be worked toward the center and discharged

Optional Accessories

Compressor Crankcase Heater

- Protects against refrigerant migration that can occur during low ambient operation

Compressor Sound Cover

- Reinforced vinyl compressor cover
- 1-1/2 inch thick batt fiberglass insulation
- All open edges are sealed with a one-inch wide hook and loop fastening tape

FEATURES

CONTROLS

Optional Accessories

iComfort® M30 Smart Wi-Fi Thermostat

- Wi-Fi-enabled, electronic 7-day, universal, multi-stage, programmable, touchscreen thermostat
- 4 Heat/2 Cool
- Auto-changeover
- Dual-fuel control with optional outdoor sensor
- Controls dehumidification during cooling mode and humidification during heating mode
- Offers enhanced capabilities including humidification / dehumidification / dewpoint measurement and control, Humiditrol® control, and equipment maintenance reminders
- Easy to read 4.3 in. color touchscreen (measured diagonally)
- LCD display with backlight shows the current and set temperature, time, inside relative humidity, system status (operating mode and schedules) and outside temperature (optional outdoor sensor required)
- Smooth Setback Recovery starts system early to achieve setpoint at start of program period
- Compressor short-cycle protection (5 minutes)
- Up to four separate schedules are available plus Schedule IQ™
- One-Touch Away Mode - A quick and easy way to set the cooling and heating setpoints while away
- Smart Away™ - Uses geo-fencing technology to determine when the homeowner is within a predetermined distance from the home to operate the system when leaving, away and arriving
- Wi-Fi remote monitoring and adjustment through a home wireless network for desktop PCs, laptops and apps for smartphones or tablets
- Smart home automation compatible with Amazon Alexa®, Google Assistant and IFTTT

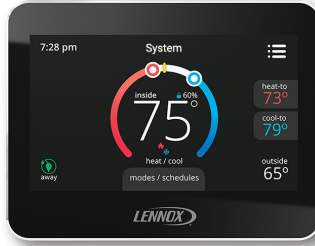

NOTE - See the iComfort® M30 Smart Wi-Fi Thermostat Product Specifications bulletin in the Controls section for more information.

Remote Outdoor Temperature Sensor

- Used with the iComfort® M30 Smart Thermostat
- Allows thermostat to display outdoor temperature

NOTE - Sensor is required for the Enhanced Dehumidification Accessory (EDA).



Thermostat

- Thermostat is not furnished with unit
- See Lennox Price Book for selection

Compressor Hard Start Kit

- Single-phase units are equipped with a PSC compressor motor
- This type of motor normally doesn't need a potential relay and start capacitor
- For conditions such as low voltage kit may be required to increase the compressor starting torque

Compressor Low Ambient Cut-Off Switch

- Non-adjustable switch (low ambient cut-out) prevents compressor operation when outdoor temperature is below 35°F

Compressor Time-Off Control

- Kit prevents compressor short-cycling and allows time for suction and discharge pressure to equalize
- Permits compressor start-up in an unloaded condition
- Automatic reset with 5 minute delay between compressor shut-off and start-up

Indoor Blower Off Delay Relay

- Delays the indoor blower-off time during the cooling cycle

Low Ambient Kit

- Air conditioners can operate down to 45°F outdoor air temperature without additional controls
- Allows unit to operate properly down to 30°F

NOTE - Crankcase heater and freezestat should be installed on compressors equipped with a low ambient kit.

NOTE - A compressor lock-out thermostat should be added to terminate compressor operation below recommended operation conditions.

FEATURES

CABINET

- 4 • Heavy-gauge steel construction
- Five station metal wash process
- Louvered heavy gauge steel panels surround unit on all four sides to prevent damage to the coil
- Powder paint finish provides superior rust and corrosion protection
- Control box is conveniently located with all controls factory wired
- Corner patch plate allows access to compressor components
- Drainage holes are provided in base section for moisture removal

PermaGuard™ Unit Base

- Durable zinc-coated base section resists rust and corrosion

5 Refrigerant Line Connections, Electrical Inlets, Service Valves

- Sweat connection suction and liquid lines
- Located on corner of unit cabinet
- Fully serviceable brass service valves
- Suction valve can be fully shut off, while liquid valve may be front seated to manage refrigerant charge while servicing system
- Refrigerant line connections and field wiring inlets are located in one central area of cabinet for easy access
- See dimension drawing

Optional Accessories

Unit Stand-Off Kit

- Black high density polyethylene feet
- Raises unit off mounting surface
- Four feet furnished per order number

SPECIFICATIONS

General Data	Model No.	Northern Region Nominal Tonnage	13ACXN018	13ACXN024	13ACXN030	13ACXN036	13ACXN042	13ACXN048	13ACXN060
Connections (sweat)		Liquid line o.d. - in.	3/8	3/8	3/8	3/8	3/8	3/8	3/8
		Suction line o.d. - in.	5/8	5/8	3/4	3/4	3/4	7/8	7/8
¹ Refrigerant (R-410A) furnished			4 lbs. 1 oz.	3 lbs. 14 oz.	5 lbs. 2 oz.	5 lbs. 4 oz.	6 lbs. 8 oz.	7 lbs. 12 oz.	9 lbs. 0 oz.
RFCIV Metering Orifice Size Furnished			0.051	0.057	0.065	0.072	0.076	0.082	0.090
Outdoor Coil	Net face area sq. ft.	Outer coil	11.33	11.33	13.22	13.22	16.33	18.67	16.33
		Inner coil	---	---	---	---	---	---	15.71
	Tube diameter - in.		5/16	5/16	5/16	5/16	5/16	5/16	5/16
	Number of rows		1	1	1	1	1	1	2
Fins per inch		26	26	26	26	26	26	26	22
Outdoor Fan	Diameter - in.		18	18	18	18	22	22	22
	Number of blades		3	3	4	4	4	4	4
	Motor hp		1/10	1/10	1/5	1/5	1/4	1/4	1/4
	Cfm		2350	2350	2400	2400	3500	3670	3600
	Rpm		1010	1010	1090	1090	825	835	830
Watts		165	165	185	185	300	295	285	
Shipping Data - lbs. 1 package			138	138	144	151	188	195	218

ELECTRICAL DATA

Line voltage data - 60 hz - 1ph			208/230V	208/230V	208/230V	208/230V	208/230V	208/230V	208/230V
² Maximum overcurrent protection (amps)			20	25	25	35	45	50	60
³ Minimum circuit ampacity			12.4	14.7	17.1	22.0	28.1	31.9	34.6
Compressor	Rated load amps		9.4	11.2	12.8	16.7	21.2	24.2	26.3
	Locked rotor amps		56.6	60.8	64	70	90	100	125
	Power factor		0.98	0.98	0.98	0.99	0.99	0.99	0.99
Condenser Fan Motor	Full load amps		0.7	0.7	1.1	1.1	1.7	1.7	1.7
	Locked rotor amps		1.3	1.3	2.0	2.0	3.2	3.2	3.2

CONTROLS - ORDER SEPARATELY

iComfort® M30 Smart Wi-Fi Thermostat	15Z69	•	•	•	•	•	•	•
Remote Outdoor Temperature Sensor	X2658	•	•	•	•	•	•	•

OPTIONAL ACCESSORIES - ORDER SEPARATELY

Compressor Crankcase Heater	93M04	•	•	•	•			
	93M05					•	•	•
Compressor Hard Start Kit	Copeland 10J42	•	•	•	•	•	•	•
	LG 88M91	•	•	•	•	•	•	•
Compressor Low Ambient Cut-Off Switch	45F08	•	•	•	•	•	•	•
Compressor Sound Cover	18J42	•	•	•	•	•	•	•
Compressor Time-Off Control	47J27	•	•	•	•	•	•	•
Freezestat	3/8 in. tubing 93G35	•	•	•	•	•	•	•
	5/8 in. tubing 50A93	•	•	•	•	•	•	•
Indoor Blower Off Delay Relay	58M81	•	•	•	•	•	•	•
Loss of Charge Switch Kit	84M23	•	•	•	•	•	•	•
⁴ Low Ambient Kit (Fan Cycling)	34M72	•	•	•	•	•	•	•
Refrigerant Line Sets	L15-26-20, L15-26-25, L15-26-35, L15-26-50	•	•					
	L15-41-20, L15-41-30, L15-41-40, L15-41-50			•	•	•		
	L15-65-30, L15-65-40, L15-65-50						•	•
Unit Stand-Off Kit	94J45	•	•	•	•	•	•	•

NOTE - Extremes of operating range are plus 10% and minus 5% of line voltage.

¹ Refrigerant charge sufficient for 15 ft. length of refrigerant lines. For longer line set requirements see the Installation Instructions for information about line set length and additional refrigerant charge required.

² HACR type circuit breaker or fuse.

³ Refer to National or Canadian Electrical Code manual to determine wire, fuse and disconnect size requirements.

⁴ Crankcase Heater and Freezestat are recommended with Low Ambient Kit.

DIMENSIONS - UNIT

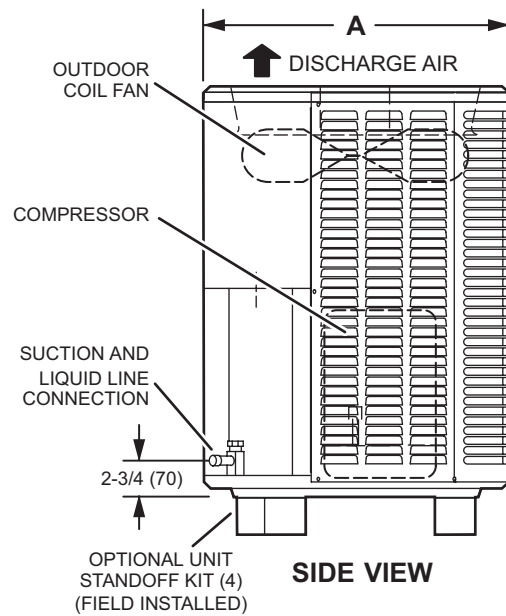
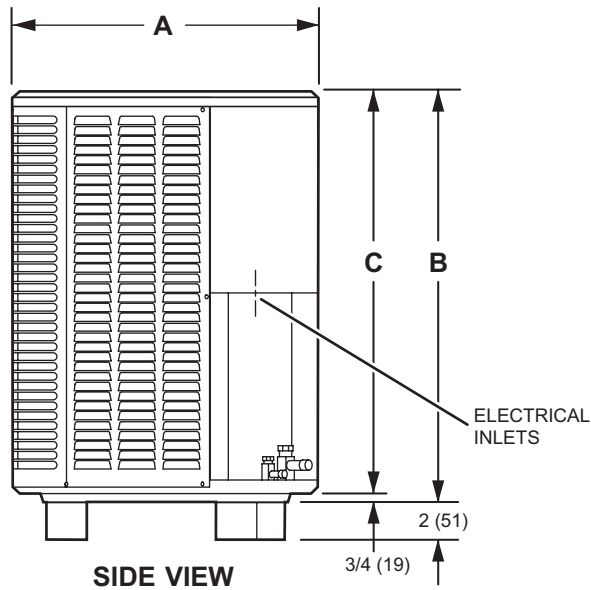
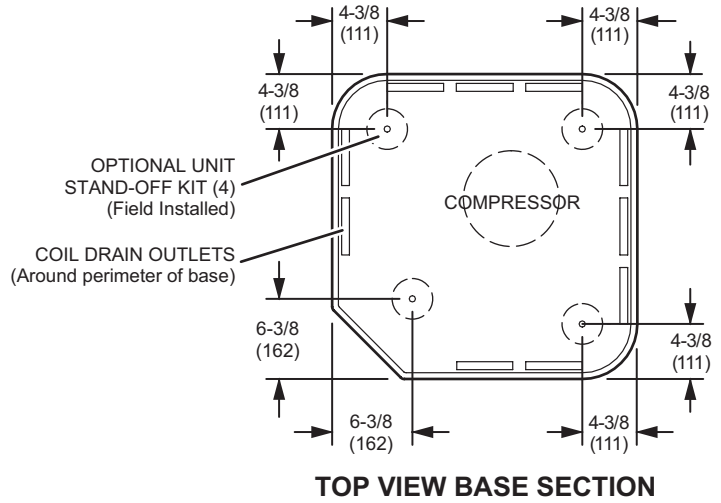
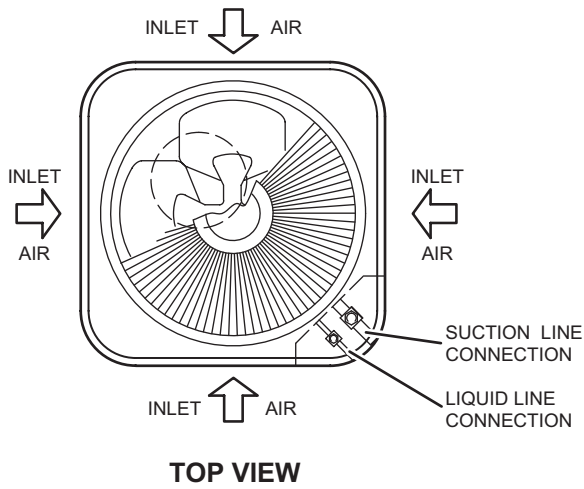

Model	A		B		C	
	inches	mm	inches	mm	inches	mm
13ACXN018	24-1/4	616	25-1/4	641	24-1/4	616
13ACXN024	24-1/4	616	25-1/4	641	24-1/4	616
13ACXN030	24-1/4	616	29-1/4	743	28-1/2	724
13ACXN036	24-1/4	616	29-1/4	743	28-1/2	724
13ACXN042	28-1/4	718	29-1/4	743	28-1/2	724
13ACXN048	28-1/4	718	33-1/4	845	32-1/2	826
13ACXN060	28-1/4	718	29-1/4	743	28-1/2	724

SOUND DATA

¹ Unit Model	Octave Band Sound Power Levels dBA, re 10 ⁻¹² Watts Center Frequency - HZ							¹ Sound Rating Number (dBA)	² Estimated Sound Pressure Level at Distance From Unit (dBA at distance in ft.)				
	125	250	500	1000	2000	4000	8000		3	5	10	15	50
018	53	60	64.5	68.5	67	61.5	54.5	76	69	64	58	55	44
024	51.5	62	64.5	68.5	67	60.5	53.5	76	69	64	58	55	44
030	52.5	62	67.5	69	67	61.5	54.5	76	69	64	58	55	44
036	52.5	61	67	69	67	61.5	52.5	76	69	64	58	55	44
042	58	68	73.5	75.5	74	69.5	62.5	79	72	67	61	58	47
048	57.5	67	73	74.5	71	64	58.5	79	72	67	61	58	47
060	57	63	69.5	71.5	71	65.5	60.5	79	72	67	61	58	47

NOTE - the octave sound power data does not include tonal correction.

¹ Tested according to AHRI Standard 270-2008 test conditions.

² Estimated sound pressure level at distance based on AHRI Standard 275-2010 method for equipment located on the ground, roof, or on side of building wall with no adjacent reflective surface within 9.8 feet. Sound pressure levels will increase based on changes to assumptions. For other applications, refer to AHRI Standard 275.

FIELD WIRING

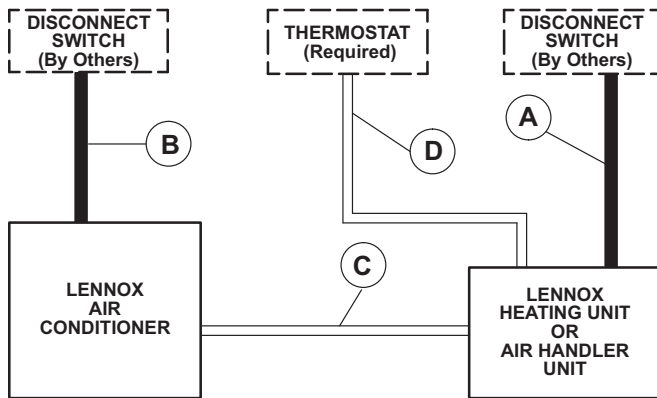

- A - Two Wire Power
- B - Two Wire Power (See Electrical Data)
- C - Two Wire Low Voltage (18 ga. minimum)
- D - Four Wire Low Voltage (Electro-Mechanical) 18 ga. minimum.
Five Wire Low Voltage (Electronic) 18 ga. minimum

NOTE - Field Wiring Not Furnished

All wiring must conform to NEC or CEC and local electrical codes.

INSTALLATION CLEARANCE

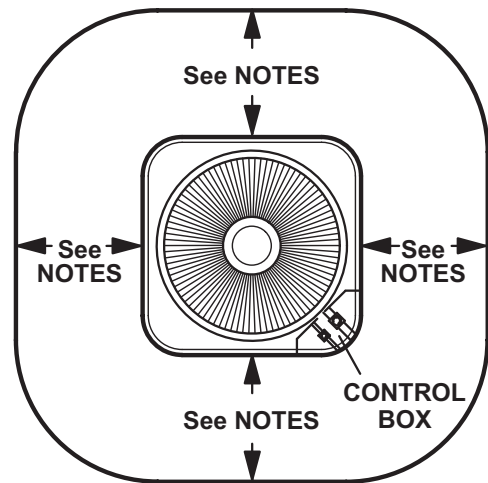

NOTES:

Service clearance of 30 in. (762 mm) must be maintained on one of the sides adjacent to the control box.

Clearance to one of the other three sides must be 36 in. (914 mm)

Clearance to one of the remaining two sides may be 12 in. (305 mm) and the final side may be 6 in. (152 mm).

A clearance of 24 in. must be maintained between two units.
48 in. (1219 mm) clearance required on top of unit.

TXV/ORIFICE USAGE

Use this table for C35, CH23, CH35 and CR33 Field Installed TXV/Orifice Match-Ups

Outdoor Unit	Refrigerant Metering Orifice (RFC)		Thermal Expansion Valve (TXV)
	Order No.	Orifice Size	
018	10W92	0.050	12J18
024	97M75	0.057	12J18
030	10W99	0.065	12J18
036	10W85	0.072	12J19
042	97M78	0.076	12J20
048	97M79	0.082	12J20
060	10M13	0.090	12J20

CX35 and CHX35 coils and all Lennox air handlers are shipped with a factory installed TXV. In most cases, no change out of the valve is needed.

If a change out is required it will be listed in the "TXV SUBSTITUTIONS" table by size. The correct TXV must be ordered separately and field installed.

C35 and CH35 coils - Use the RFC orifice shipped with the outdoor unit or replace the factory installed RFC orifice with the expansion valve listed.

CR33 and CH23 coils - Use the RFC orifice shipped with the outdoor unit or use the expansion valve listed.

TXV SUBSTITUTION

A general guide for replacing the factory installed TXV if the indoor unit (coil/air handler) is larger than the outdoor unit.

Outdoor Unit		Indoor Unit		TXV	TXV
Size	Tons	Size	Tons	Furnished	Replacement
024	2	38	3.5	12J19	12J18
024	2	42	3.5	12J20	12J18
024	2	48	4	12J20	12J18
024	2	49	4	12J20	12J18
030	2.5	38	3.5	12J19	12J18
030	2.5	42	3.5	12J20	12J18
030	2.5	43	3.5	12J20	12J18
030	2.5	44/48	4	12J20	12J18
030	2.5	48	4	12J20	12J18
030	2.5	50/60	4	12J20	12J18

TXV Ranges:

12J18 - 1.5 to 2.5 ton systems - Use on 2.5 ton and lower systems.

12J19 - 3 ton systems - Use down to 2 ton systems.

12J20 - 3.5 to 5 ton systems - Use down to 3 ton systems.

AHRI STANDARD 210/240

Cooling or heating capacities are net values, including the effects of blower motor heat, and do not include supplementary heat. Power input is the total power input to the compressor(s) and fan(s), plus any controls and other items required as part of the system for normal operation.

Units which do not have an indoor air-circulating blower furnished as part of the model, i.e., split system with indoor coil only, is established by subtracting from the total cooling capacity 1250 Btu/h per 1,000 cfm, and by adding the same amount to the heating capacity. Total power input for both heating and cooling is increased by 365 W per 1,000 cfm of indoor air circulated.

REVISIONS

Sections	Description of Change
Approvals and Warranty	Corrected compressor warranty.



Visit us at www.lennox.com

For the latest technical information, www.LennoxPros.com

Contact us at 1-800-4-LENNOX

NOTE - Due to Lennox' ongoing commitment to quality, Specifications, Ratings and Dimensions subject to change without notice and without incurring liability. Improper installation, adjustment, alteration, service or maintenance can cause property damage or personal injury. Installation and service must be performed by a qualified installer and servicing agency.

©2020 Lennox Industries, Inc.