



CBA38MV
 DAVE LENNOX SIGNATURE® COLLECTION
 R-410A Ready - Multi-Position - Variable Speed - 60 Hz

**RESIDENTIAL
 PRODUCT SPECIFICATIONS**

Bulletin No. 210803
 October 2020
 Supersedes August 2018



Nominal Capacity - 1.5 to 5 Tons
Optional Electric Heat - 4 to 25 kW

MODEL NUMBER IDENTIFICATION

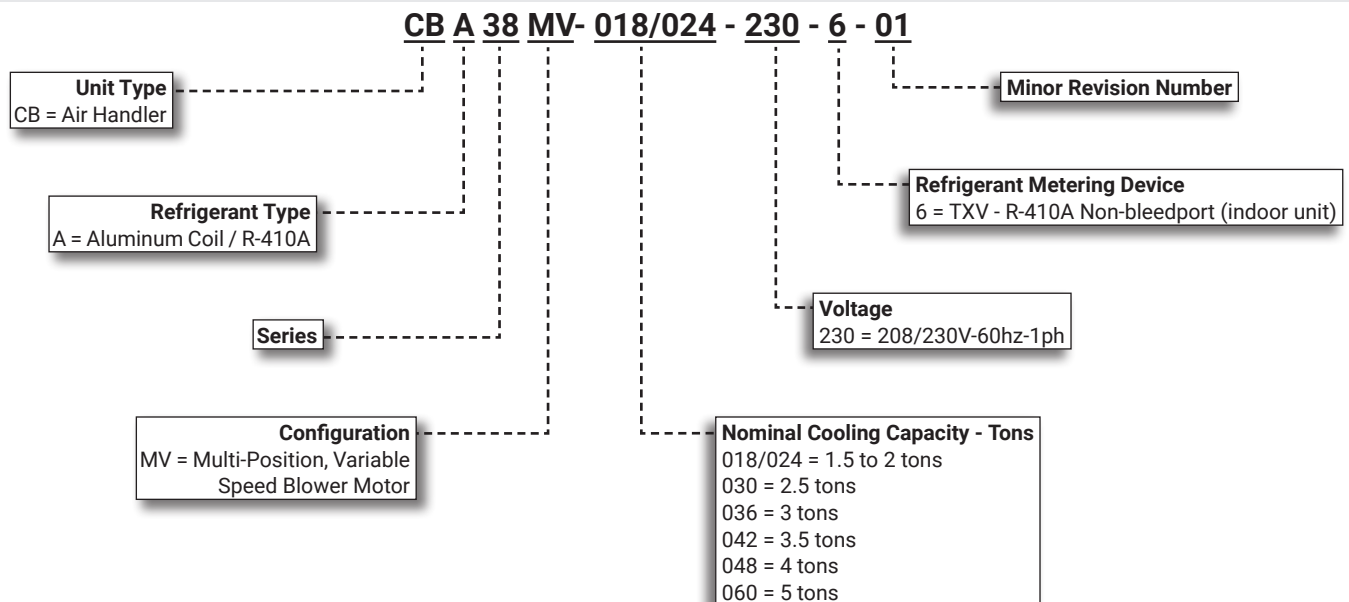

FEATURE HIGHLIGHTS

1. Quantum™ Coil
2. Refrigerant Line Connections
3. Check and Expansion Valve
4. Heavy Gauge Steel Two-Piece Cabinet
5. Dual Position Drain Pans
6. Air Filter
7. Variable Blower Motor
8. iComfort® Communicating Control
9. Transformer
10. Electric Heat (option)

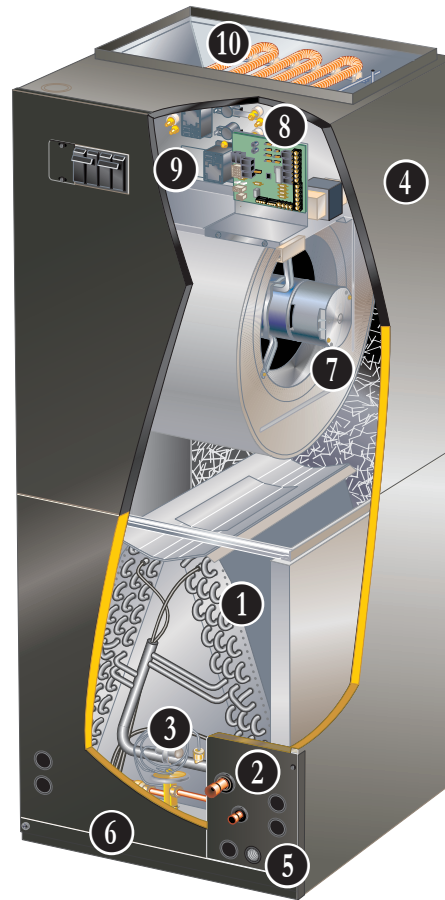

CONTENTS

Approvals And Warranty	3
Blower Data	10
Dimensions - Accessories	28
Dimensions - Unit	24
Electrical Data	8
Electric Heat Data	16
Features	3
Installation Clearances With Electric Heat	8
Optional Accessories - Order Separately	8
Replacement Circuit Breakers	9
Specifications	8

APPROVALS AND WARRANTY

APPROVALS

- Tested with matching air conditioners and heat pump units in the Lennox Research Laboratory environmental test room in accordance with AHRI Standard 210/240
- AHRI Certified system match-ups and expanded ratings, visit www.LennoxPros.com
- ETL Listed to US and Canadian safety standards and components within are bonded for grounding to meet safety standards for servicing required by NEC and CEC
- Optional electric heaters are ETL listed and rated in accordance with US Department of Energy (DOE) test procedures and Federal Trade Commission (FTC) labeling regulations
- Blower performance data according to unit tests conducted in Lennox air test chamber
- Approved for installation in manufactured housing and mobile homes
- ISO 9001 Registered Manufacturing Quality System

WARRANTY

- All covered components
 - Limited ten years in residential applications
 - Limited one year in non-residential applications

NOTE - Refer to Lennox Equipment Limited Warranty certificate included with unit for specific details.

FEATURES

APPLICATIONS

- 1.5 to 5 ton nominal sizes
- Multi-position (upflow, downflow or horizontal) applications
- Applicable to expansion valve systems in R-410A cooling applications and check and expansion valve systems in R-410A heat pump applications
- Wide-range check and expansion valve is factory installed
- Applicable to Lennox' iHarmony® Zoning System
- Optional field installed electric heaters available in several sizes for additive heating capacity

ZONING APPLICATIONS

- Units can be used with certain zoning systems. Zone control panel MUST be able to interface and communicate with the variable speed motor in the unit.
- Lennox iHarmony® Zoning System has this capability

REFRIGERANT SYSTEM

- 1 Quantum™ Coil**
 - Lennox designed and fabricated coil
 - Enhanced aluminum alloy tube/enhanced fin coil for superior corrosion resistance
 - Aluminum tubing, hairpins, distributor and header tubes.
 - Ripple-edged aluminum fins
 - Twin coil construction assembled in a "A" configuration for large surface area
 - Provides excellent heat transfer and low air resistance for maximum efficiency
 - Precise circuiting for uniform refrigerant distribution
 - Lanced fins provide maximum exposure of fin surface to air stream
 - Rifled tubing provides superior heat transfer

- Coil thoroughly factory tested under high pressure to ensure leakproof construction

- 2 Refrigerant Line Connections**

- Copper refrigerant sweat connections on both liquid and suction lines for easy brazing.
- Lines extend outside of the cabinet for ease of connection.
- See dimension drawings for locations

- 3 Check and Expansion Valve Furnished**

- For use with R-410A systems
- Wide range valve with Chatleff style fitting
- Factory installed on all models, internal to cabinet

CABINET

- 4**
 - Constructed of heavy-gauge galvanized steel
 - Completely insulated with thick fiberglass insulation
 - Pre-painted steel cabinets have mildly textured enamel finish with primer coat on unpainted side of all panels
 - Units are shipped in one piece but may be disassembled into two separate sections for ease of installation in tight applications
 - Thick rubber gasket between sections of the two piece cabinets provides an air tight seal
 - No external screw heads on sides of cabinet for tight installations without damage to walls or woodwork
 - Removable panels provide complete service access
 - Electrical inlets provided in sides and top of cabinet
 - See dimension drawings for locations

Low Leakage Cabinet

- All models have less than 2% air leakage and meet ANSI/ASHRAE Standard 193-2010 "Method of Test for Determining the Air Tightness of HVAC Equipment"

FEATURES

CABINET (continued)

Multi-Position Capability

- Shipped for upflow and horizontal right-hand discharge
- Quickly converted to downflow or left-hand, horizontal air discharge
- Easily converts to downflow position with furnished coil support rails and filter support rack

5 Dual Position Microbial Drain Pans

- Designed for upflow, downflow or horizontal applications
- Deep, corrosion resistant plastic drain pans have dual pipe drains
- Anti-Microbial additive resists growth of mold and mildew on drain pan which improves indoor air quality and reduces drain line blockage
- See dimension drawings

Optional Accessories

Downflow Combustible Flooring Base

- Base is required for models with electric heat installed in downflow position on combustible floors

Horizontal Support Frame Kit

- Provides support of unit in horizontal applications
- Consists of (2) 1 x 1-1/2 x 32-5/8 in. and (2) 1 x 3 x 53-7/8 in. painted heavy gauge cold rolled steel support channels with assembly and suspending holes
- Bolts and nuts furnished for field assembly
- Suspending rods must be field provided

Side Return Unit Stand (Upflow Only)

- Raises unit 16 in. above floor for side return air duct connection
- Eliminates need for wooden platform construction
- All aluminum construction
- Two adjustable frames fit all sizes

Wall Hanging Bracket Kit (Upflow Only)

- Allows unit to be hung on wall at any height
- Consists of heavy-gauge steel support brackets (one for air handler, one for wall mount)
- Screws furnished for fastening one bracket to unit
- Bolts for fastening one bracket to wall are field provided

High Performance Economizer (Commercial Applications Only)

- Designed for applications requiring outdoor air to be utilized in a commercial HVAC system
- Allows the entry of fresh outdoor air for free cooling, reducing the requirement for mechanical cooling
- Heavy gauge galvanized steel cabinet lined with thick fiberglass insulation
- Mixed air sensor, outdoor air sensor and 24VAC transformer furnished
- Approved for California Title 24 building standards
- ASHRAE 90.1-2010 compliant
- See separate Product Specifications bulletin for additional information and available control and sensor options

NOTE - Economizer is not iComfort® compatible.

FILTER

- 6** • Disposable 1 inch filter is furnished
- Filter rack furnished in cabinet for easy filter installation
- See Specifications tables for filter sizes

BLOWER

7 Variable-Speed Blower Motor

- High efficiency multi-speed blower motor maintains specified air volumes up to a maximum of 0.8 in. w.g. total external static
- Multi-speed operation is achieved by the use of an ECM (Electronically Commutated Motor) motor
- Allows cooling ramping profiles (field selectable) for enhanced dehumidification
- Motor accelerates and decelerates gradually, reducing start-up and shut-down sound
- Leadless blower motor features simple plug-in connections
- Motor is controlled by the iComfort® communicating control that allows blower to operate at two of eight air volumes or speeds available
- Speeds may be field selected on iComfort® communicating control depending on size of air handler and air volume desired
- See blower performance tables

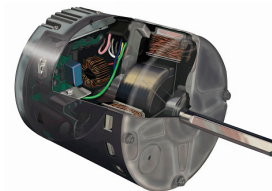

Blower Assembly

- Lennox designed and built, direct drive blower
- Each blower is statically and dynamically balanced as an assembly before installation in the unit
- Blower motor is resiliently mounted to blower assembly
- Blower slides out of cabinet for servicing

FEATURES

CONTROLS

8 iComfort® Communicating Control

- Advanced control communicates information about various operating parameters in the air handler to the optional iComfort® Communicating Thermostat to constantly maintain the highest level of comfort, performance and efficiency available
- **Auto Configuration** - On start-up the control board automatically sends a description of the unit to the optional iComfort® Communicating Thermostat to automatically configure the number of stages and features available
- Connections for connecting a conventional heating/cooling thermostat are also provided on the board
- **Control also features:**
 - Lennox Humiditrol® Whole Home Dehumidification System (EDA) compatible
 - EEPROM storage of all local configurations
 - Non-volatile memory storage of 100 alarm codes with display of last 10 codes for troubleshooting
 - Connections for optional outdoor temperature sensor (communicates temperature on RSBUS to thermostat)
 - Controls evaporator humidity by controlling blower and compressor staging on two-stage outdoor units
 - **Two Stages** - HEAT and COOL (with four different air volume selections for each) are made by simple jumper pins on board
 - ADJUST jumper pin allows approximately 10% higher, normal or 10% lower motor speed selection within HEAT and COOL speeds selected for fine tuning air volume
 - DELAY jumper pin allows selection of blower motor dehumidification profiles during cooling mode
 - **Option 1** - Motor runs at 100% of capacity until demand met. Once demand is met, motor ramps down to stop.
 - **Option 2 Cooling** - When cool demand is initiated, motor ramps up to 100% and runs at 100% until demand is satisfied. Once demand is met, motor runs at 100% for 45 seconds, then ramps down to stop.
 - **Option 2 Heat Pump**: When heat pump demand is initiated, 30 second motor on delay starts. After the motor on delays expires, motor ramps up to 100% and runs at 100% until demand is satisfied. Once demand is met, motor runs at 100% for 45 seconds, then ramps down to stop.
 - **Option 3** - Motor runs at 82% of capacity for approximately 7.5 minutes, then 100% capacity (if needed) until demand is satisfied. Once demand is met, motor ramps down to stop.

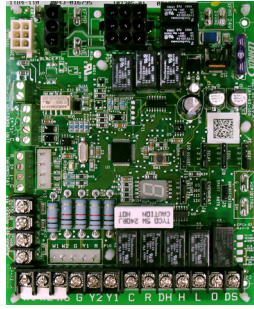

- **Option 4** - Motor runs at 50% capacity for 30 seconds, then 82% capacity for approximately 7.5 minutes. If demand is not satisfied, motor runs at 100% capacity until demand is met. Once demand is met, motor runs at 50% capacity for 30 seconds, then ramps down to stop.

- **Display LED** - Seven segment LED displays alphanumeric information related to diagnostics as well as system operation and status
 - Diagnostic codes are held in non-volatile memory, immune from power interruptions
 - Holds up to ten diagnostic codes in order of occurrence for recall on demand
 - Port on blower door allows for easy viewing
 - **Dehumidification (Active or Humiditrol® Option)** - A jumper on the control board must be clipped to enable active dehumidification and/or operation with a Humiditrol Whole-Home Dehumidification System
 - During a call for cooling, air volume is automatically reduced, forcing humidity removal by the air conditioner or heat pump system
 - After the humidity has reached the desired set-point the cooling air volume returns to its designed rate
 - A dehumidification signal from the thermostat reduces the cooling cfm to 70% of the requested cooling cfm
- NOTE** - A humidity controlling thermostat or device is also required.
- **Electric Heat Operation** - Control for up to three electric heat stages
 - **EvenHeater® Electric Heat Control** - Up to four electric heat stages are available when utilizing the EvenHeater® control feature furnished on the iComfort® Communicating control
 - EVENHEAT jumper position on control board determines target discharge air temperature of 85°F, 100°F, 115°F or 130°F
 - Default setting is 85°F

NOTE - Optional Discharge Air Sensor is required.

- **Heat Pump Operation** - A jumper on the control board must be clipped to enable operation with a single or two-stage heat pump
 - The indoor blower is started without delay when a call for heat is received
 - **Two-Stage Cooling Operation** - A jumper on the control board must be clipped to enable operation with a two-stage air conditioner
 - The cooling blower speeds for first and second stage cooling will be dictated by the applicable DIP switch settings
 - **Lennox System Operations Monitor Connection** - Monitors outdoor unit operation. (communicating mode)
 - **Continuous Blower Speed** - Adjustable continuous blower speed is a percentage of the high cooling speed selection. There are four selectable options (via DIP switch settings) of 28%, 38% (default setting), 70% and 100%
- 9 • **Transformer** - 70VA transformer furnished as standard. Factory installed in the unit control box

FEATURES

CONTROLS (continued)

iComfort® Communicating Control (continued)

- **Accessory Terminal** - One 24 volt humidifier output is furnished for non-powered humidifiers
- Control board is factory installed in the unit control box

Optional Accessories

iComfort® S30 Ultra-Smart Wi-Fi Thermostat (part of the iComfort® Residential Communicating Control System)

- Recognizes and connects to all iComfort® Communicating products to automatically configure and control the heating/cooling system (based on user-specified settings) for the highest level of comfort, performance and efficiency
- Recognizes model and serial number information for iComfort® Communicating products to simplify system setup
- Wi-Fi remote temperature monitoring and adjustment through a home wireless network for desktop PCs, laptops and apps for smartphones or tablets
- Smart home automation compatible with Apple HomeKit™, Amazon Alexa®, Google Assistant and IFTTT
- Service alerts and reminders sent via text message or e-mail
- Service Dashboard features online real-time monitoring of installed iComfort® Communicating systems
- Simple easy-to-use touchscreen allows complete system configuration
- Scheduled maintenance alerts, system warnings and troubleshooting are also displayed on thermostat screen
- Easy to read 7 inch high definition color display (measured diagonally)
- Conventional outdoor units (not iComfort® Communicating) can easily be added and controlled by the iComfort® S30 Thermostat
- Installer setup screens allow quick and simple system configuration without a manual, Installer can also run tests on complete system or individual components for easy maintenance and troubleshooting
- Serial communications bus (RSBus), with less wiring than a conventional heating/cooling system, allows system communication
- Uses 4-wire, standard thermostat wiring
- High Definition Color Display with Subbase, Smart Hub Controller, wallplate (for retrofit installations) furnished for easy installation



Remote Outdoor Temperature Sensor

- Used with the iComfort® S30 Smart Wi-Fi Thermostat
- Outdoor sensor allows thermostat to display outdoor temperature
- Automatically detected when connected to thermostat

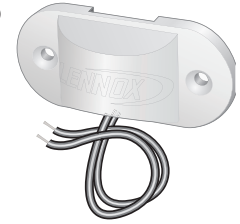

NOTE - Sensor is required for the Enhanced Dehumidification Accessory (EDA).

NOTE - Sensor is furnished as standard with iComfort® Communicating outdoor units, optional for conventional units.

Thermostat

- Thermostat is not furnished with unit
- See Lennox Price Book for selection

Hot Water Heat Kit

- Controls a third-party hot water boiler with a hot water heating coil installed downstream from the air handler
- Kit contains all necessary relays and plug-in wiring harness to control boiler

NOTE - This kit is only approved for use in systems using an iComfort® Communicating thermostat ComfortSense® 7500 thermostat

NOTE - See the iComfort® S30 Thermostat Product Specifications bulletin in the Controls section for more information

FEATURES

10 **OPTIONAL ELECTRIC HEAT**

- ETL listed
- Field install internal to unit cabinet
- Available in several voltages and kW sizes
- See Electric Heat tables
- Helix wound nichrome heating elements exposed directly in air stream resulting in instant heat transfer, low element temperatures and long service life
- Each element equipped with accurately located limit control with fixed temperature off setting and automatic reset
- Supplemental thermal cutoff limit control, provides positive protection in case of excessive temperatures
- Thermal sequencer relay brings elements on and off line, in sequence and equal increments, with time delay between each
- Initiates and terminates blower operation
- Heating control relay(s) furnished as standard
- Control box and access cover constructed of heavy gauge galvanized steel
- Factory assembled with controls installed and wired
- Electric heat low voltage controls plug-in to air handler

Circuit Breaker (CB) Models

- All "CB" model heaters are equipped with circuit breakers for overload and short circuit protection
- Factory wired and mounted on electric heat unit
- Current sensitive and temperature actuated
- Manual reset
- Circuit breakers qualify as disconnect means at unit in many areas, eliminate the need for field provided disconnect
- Consult local electrical code in your area

Optional Accessories

Circuit Breaker Cover Kit

- Flexible plastic cover protects circuit breaker
- Recommended in areas with high humidity or unconditioned areas to prevent nuisance tripping

Single-Point Power Source Control Box

- Control Box may be used with optional electric heat when single power supply is connected to multi-circuit electric heat
- Field installs external to the unit cabinet on either side or top
- Constructed of heavy gauge steel, baked enamel finish, pre-punched mounting holes, electrical inlet knockouts, and terminal strip
- Removable cover provides easy access
- Dimensions (H x W x D) - 7 x 7 x 4 in.

SPECIFICATIONS

General Data		Model Number	CBA38MV-018/024	CBA38MV-030	CBA38MV-036
	Nominal tonnage		1.5 to 2	2.5	3
	Factory Installed Expansion Valve		12J18	12J18	12J19
	Refrigerant		R-410A	R-410A	R-410A
Connections in.	Suction / vapor (o.d.) line - sweat		3/4	3/4	3/4
	Liquid line (o.d.) - sweat		3/8	3/8	3/8
	Condensate drain - in. (fpt)		(2) 3/4	(2) 3/4	(2) 3/4
Indoor Coil	Net face area - ft. ²		4.4	5.0	5.0
	Tube outside diameter - in.		3/8	3/8	3/8
	Number of rows		3	3	3
	Fins per inch		14	14	14
Blower Data	Wheel nominal diameter x width - in.		10 x 8	11 x 8	11 x 8
	Motor output - hp		1/2	1/2	3/4
Filters	¹ Number and size - in.		(1) 20 x 20 x 1	(1) 20 x 20 x 1	(1) 20 x 20 x 1
Shipping Data - 1 Package - lbs.			141	154	159

ELECTRICAL DATA

	Voltage - phase - 60hz		208/230V-1ph	208/230V-1ph	208/230V-1ph
	² Maximum overcurrent protection (unit only)		15	15	15
	³ Minimum circuit ampacity (unit only)		5	5	5

CONTROLS

iComfort® S30 Ultra-Smart Wi-Fi Thermostat		19V30	19V30	19V30
⁴ Remote Outdoor Air Temperature Sensor (for dual fuel and EDA)		X2658	X2658	X2658
⁵ Discharge Air Temperature Sensor		88K38	88K38	88K38

OPTIONAL ACCESSORIES - ORDER SEPARATELY

Circuit Breaker Cover Kit		82W01	82W01	82W01
Downflow Combustible Flooring Base		44K15	44K15	44K15
Electric Heat	See Electric Heat Data tables			
Horizontal Support Frame Kit		56J18	56J18	56J18
Hot Water Heat Kit		90W84	90W84	90W84
Side Return Unit Stand (Upflow)		45K32	45K32	45K32
Single-Point Power Source Control Box		21H39	21H39	21H39
Wall Hanging Bracket Kit (Upflow)		45K30	45K30	45K30
High Performance Economizer (Commercial Only)		10U53	10U53	10U53

¹ Disposable frame type filter.

² HACR type circuit breaker or fuse.

³ Refer to National or Canadian Electrical Code manual to determine wire, fuse and disconnect size requirements. Use wires suitable for at least 167°F.

⁴ Remote Outdoor Temperature Sensor is used with conventional (non-iComfort® Communicating) outdoor units (sensor is furnished with iComfort® Communicating outdoor units). Allows the thermostat to display outdoor temperature. Required in dual-fuel and Humiditrol® applications.

⁵ Optional for EvenHeater® electric heat operation and service diagnostics.

INSTALLATION CLEARANCES WITH ELECTRIC HEAT

Cabinet	0 inch (0 mm)
To Plenum	0 inch (0 mm)
To Outlet Duct within 3 feet (914 mm)	0 inch (0 mm)
Floor	See Note #1
Service / Maintenance	See Note #2

¹ Units installed on combustible floors in the downflow position with electric heat require optional downflow combustible flooring base.

² Front service access - 24 inches (610 mm) minimum.

NOTE - If cabinet depth is more than 24 inches (610 mm), allow a minimum of the cabinet depth plus 2 inches (51 mm).

SPECIFICATIONS

General Data		Model Number	CBA38MV-042	CBA38MV-048	CBA38MV-060
	Nominal tonnage		3.5	4	5
	Factory Installed Expansion Valve		12J20	12J20	12J20
	Refrigerant		R-410A	R-410A	R-410A
Connections in.	Suction / vapor (o.d.) line - sweat		7/8	7/8	7/8
	Liquid line (o.d.) - sweat		3/8	3/8	3/8
	Condensate drain - in. (fpt)		(2) 3/4	(2) 3/4	(2) 3/4
Indoor Coil	Net face area - ft. ²		7.22	7.22	8.33
	Tube outside diameter - in.		3/8	3/8	3/8
	Number of rows		3	3	3
	Fins per inch		14	14	14
Blower Data	Wheel nominal diameter x width - in.		12 x 9	12 x 9	12 x 9
	Motor output - hp		1	1	1
Filters	¹ Number and size - in.		(1) 20 x 24 x 1	(1) 20 x 24 x 1	(1) 20 x 24 x 1
Shipping Data - 1 Package - lbs.			189	189	199

ELECTRICAL DATA

	Voltage - phase - 60hz	208/230V-1ph	208/230V-1ph	208/230V-1ph
	² Maximum overcurrent protection (unit only)	15	15	15
	³ Minimum circuit ampacity (unit only)	10	10	10

CONTROLS

iComfort® S30 Ultra-Smart Wi-Fi Thermostat	19V30	19V30	19V30
⁴ Remote Outdoor Air Temperature Sensor (for dual fuel and EDA)	X2658	X2658	X2658
⁵ Discharge Temperature Sensor	88K38	88K38	88K38

OPTIONAL ACCESSORIES - order separately

Circuit Breaker Cover Kit	82W01	82W01	82W01
Downflow Combustible Flooring Base	44K15	44K15	44K15
Electric Heat	See Electric Heat Data tables		
Horizontal Support Frame Kit	56J18	56J18	56J18
Hot Water Heat Kit	90W84	90W84	90W84
Side Return Unit Stand (Upflow)	45K32	45K32	45K32
Single-Point Power Source Control Box	21H39	21H39	21H39
Wall Hanging Bracket Kit (Upflow)	45K30	45K30	45K30
High Performance Economizer (Commercial Only)	10U53	10U53	10U53

¹ Disposable frame type filter.

² HACR type circuit breaker or fuse.

³ Refer to National or Canadian Electrical Code manual to determine wire, fuse and disconnect size requirements. Use wires suitable for at least 167°F.

⁴ Remote Outdoor Temperature Sensor is used with conventional (non-iComfort® Communicating) outdoor units (sensor is furnished with iComfort® Communicating outdoor units). Allows the thermostat to display outdoor temperature. Required in dual-fuel and Humiditrol® applications.

⁵ Optional for EvenHeater® electric heat operation and service diagnostics.

REPLACEMENT CIRCUIT BREAKERS

Voltage	Description	Catalog No.
208/240V - 1 Phase	25 amp, 2 pole	41K13
	30 amp, 2 pole	17K70
	35 amp, 2 pole	72K07
	40 amp, 2 pole	49K14
	45 amp, 2 pole	17K71
	50 amp, 2 pole	41K12
	60 amp, 2 pole	17K72
208/240V - 3 Phase	30 amp, 3 pole	64W47
	35 amp, 3 pole	41K14
	40 amp, 3 pole	41K16
	45 amp, 3 pole	18M86
	50 amp, 3 pole	41K15
	60 amp, 3 pole	41K17

BLOWER DATA

CBA38MV-018/024 BLOWER PERFORMANCE

0 through 0.80 in. w.g. External Static Pressure Range

"ADJUST" Jumper Setting	Jumper Speed Positions							
	"HEAT" Speed				"COOL" Speed			
	1 cfm	2 cfm	3 cfm	4 cfm	1 cfm	2 cfm	3 cfm	4 cfm
+	460	685	885	1050	460	685	885	1050
NORM	400	575	795	940	400	575	795	940
-	365	515	715	830	365	515	715	830

NOTES - The effect of static pressure, filter and electric heater resistance is included in the air volumes listed.

First stage cooling air volume is 70% of COOL speed setting. Continuous fan speed is approximately 28%, 38%, 70% and 100% (Jumper selectable) of the same second-stage COOL speed selected, minimum 250 cfm.

Lennox iHarmony® Zoning System applications - minimum blower speed is 250 cfm.

CBA38MV-018/024 BLOWER MOTOR WATTS

AT "+" (Plus) SETTING ("Adjust" Jumper at "+" Setting)

Jumper Speed Positions		Motor Watts @ Various External Static Pressures - in. wg.								
		0	0.1	0.2	0.3	0.4	0.5	0.6	0.7	0.8
"HEAT" Speed	Tap 1	NA	32	44	58	71	90	104	131	145
	Tap 2	NA	56	85	103	121	139	165	190	207
	Tap 3	NA	105	131	161	183	202	241	263	292
	Tap 4	NA	164	194	220	253	277	310	330	360
"COOL" Speed	Tap 1	NA	32	44	58	71	90	104	131	145
	Tap 2	NA	56	85	103	121	139	165	190	207
	Tap 3	NA	105	131	161	183	202	241	263	292
	Tap 4	NA	164	194	220	253	277	310	330	360

AT "NORM" SETTING ("Adjust" Jumper at NORM Setting)

Jumper Speed Positions		Motor Watts @ Various External Static Pressures - in. wg.								
		0	0.1	0.2	0.3	0.4	0.5	0.6	0.7	0.8
"HEAT" Speed	Tap 1	NA	27	42	52	69	79	99	114	133
	Tap 2	NA	44	59	77	95	117	137	152	183
	Tap 3	NA	79	108	126	159	181	199	231	252
	Tap 4	NA	117	145	167	197	228	254	273	313
"COOL" Speed	Tap 1	NA	27	42	52	69	79	99	114	133
	Tap 2	NA	44	59	77	95	117	137	152	183
	Tap 3	NA	79	108	126	159	181	199	231	252
	Tap 4	NA	117	145	167	197	228	254	273	313

AT "-" (Minus) SETTING ("Adjust" Jumper at "-" Setting)

Jumper Speed Positions		Motor Watts @ Various External Static Pressures - in. wg.								
		0	0.1	0.2	0.3	0.4	0.5	0.6	0.7	0.8
"HEAT" Speed	Tap 1	NA	24	40	48	60	76	94	106	117
	Tap 2	NA	37	48	68	93	106	129	145	157
	Tap 3	NA	70	85	106	129	153	181	203	222
	Tap 4	NA	90	117	138	162	190	216	236	265
"COOL" Speed	Tap 1	NA	24	40	48	60	76	94	106	117
	Tap 2	NA	37	48	68	93	106	129	145	157
	Tap 3	NA	70	85	106	129	153	181	203	222
	Tap 4	NA	90	117	138	162	190	216	236	265

BLOWER DATA

CBA38MV-030 BLOWER PERFORMANCE

0 through 0.80 in. w.g. External Static Pressure Range

"ADJUST" Jumper Setting	Jumper Speed Positions							
	"HEAT" Speed				"COOL" Speed			
	1 cfm	2 cfm	3 cfm	4 cfm	1 cfm	2 cfm	3 cfm	4 cfm
+	630	875	1095	1315	630	875	1095	1315
NORM	545	785	995	1195	545	785	995	1195
-	510	700	890	1075	510	700	890	1075

NOTES - The effect of static pressure, filter and electric heater resistance is included in the air volumes listed.

First stage cooling air volume is 70% of COOL speed setting. Continuous fan speed is approximately 28%, 38%, 70% and 100% (Jumper selectable) of the same second-stage COOL speed selected, minimum 250 cfm.

Lennox iHarmony® Zoning System applications - minimum blower speed is 250 cfm.

CBA38MV-030 BLOWER MOTOR WATTS

AT "+" (Plus) SETTING ("Adjust" Jumper at "+" Setting)

Jumper Speed Positions		Motor Watts @ Various External Static Pressures - in. wg.								
		0	0.1	0.2	0.3	0.4	0.5	0.6	0.7	0.8
"HEAT" Speed	Tap 1	NA	35	55	76	95	116	138	164	179
	Tap 2	NA	80	100	122	148	171	194	214	239
	Tap 3	NA	140	167	189	216	237	273	291	322
	Tap 4	NA	231	262	295	328	355	377	412	441
"COOL" Speed	Tap 1	NA	35	55	76	95	116	138	164	179
	Tap 2	NA	80	100	122	148	171	194	214	239
	Tap 3	NA	140	167	189	216	237	273	291	322
	Tap 4	NA	231	262	295	328	355	377	412	441

AT "NORM" SETTING ("Adjust" Jumper at NORM Setting)

Jumper Speed Positions		Motor Watts @ Various External Static Pressures - in. wg.								
		0	0.1	0.2	0.3	0.4	0.5	0.6	0.7	0.8
"HEAT" Speed	Tap 1	NA	36	48	61	80	92	114	124	139
	Tap 2	NA	61	84	104	122	143	169	186	210
	Tap 3	NA	109	134	153	178	203	231	254	281
	Tap 4	NA	174	205	238	264	284	310	338	372
"COOL" Speed	Tap 1	NA	36	48	61	80	92	114	124	139
	Tap 2	NA	61	84	104	122	143	169	186	210
	Tap 3	NA	109	134	153	178	203	231	254	281
	Tap 4	NA	174	205	238	264	284	310	338	372

AT "-" (Minus) SETTING ("Adjust" Jumper at "-" Setting)

Jumper Speed Positions		Motor Watts @ Various External Static Pressures - in. wg.								
		0	0.1	0.2	0.3	0.4	0.5	0.6	0.7	0.8
"HEAT" Speed	Tap 1	NA	29	43	58	77	88	102	119	134
	Tap 2	NA	44	64	89	106	125	157	174	202
	Tap 3	NA	85	104	129	152	176	199	219	239
	Tap 4	NA	133	157	185	207	231	258	285	317
"COOL" Speed	Tap 1	NA	29	43	58	77	88	102	119	134
	Tap 2	NA	44	64	89	106	125	157	174	202
	Tap 3	NA	85	104	129	152	176	199	219	239
	Tap 4	NA	133	157	185	207	231	258	285	317

BLOWER DATA

CBA38MV-036 BLOWER PERFORMANCE

0 through 0.80 in. w.g. External Static Pressure Range

"ADJUST" Jumper Setting	Jumper Speed Positions							
	"HEAT" Speed				"COOL" Speed			
	1 cfm	2 cfm	3 cfm	4 cfm	1 cfm	2 cfm	3 cfm	4 cfm
+	920	1255	1410	1580	920	1255	1410	1580
NORM	815	1165	1315	1435	815	1165	1315	1435
-	720	1010	1155	1285	720	1010	1155	1285

NOTES - The effect of static pressure, filter and electric heater resistance is included in the air volumes listed.

First stage cooling air volume is 70% of COOL speed setting. Continuous fan speed is approximately 28%, 38%, 70% and 100% (Jumper selectable) of the same second-stage COOL speed selected, minimum 250 cfm.

Lennox iHarmony® Zoning System applications - minimum blower speed is 250 cfm.

CBA38MV-036 BLOWER MOTOR WATTS

AT "+" (Plus) SETTING ("Adjust" Jumper at "+" Setting)

Jumper Speed Positions		Motor Watts @ Various External Static Pressures - in. wg.								
		0	0.1	0.2	0.3	0.4	0.5	0.6	0.7	0.8
"HEAT" Speed	Tap 1	n/a	88	108	132	161	190	208	234	248
	Tap 2	n/a	174	212	237	269	304	328	370	385
	Tap 3	n/a	232	282	314	341	374	410	434	473
	Tap 4	n/a	332	365	409	438	480	520	546	576
"COOL" Speed	Tap 1	n/a	88	108	132	161	190	208	234	248
	Tap 2	n/a	174	212	237	269	304	328	370	385
	Tap 3	n/a	232	282	314	341	374	410	434	473
	Tap 4	n/a	332	365	409	438	480	520	546	576

AT "NORM" SETTING ("Adjust" Jumper at NORM Setting)

Jumper Speed Positions		Motor Watts @ Various External Static Pressures - in. wg.								
		0	0.1	0.2	0.3	0.4	0.5	0.6	0.7	0.8
"HEAT" Speed	Tap 1	n/a	70	89	113	137	155	188	199	233
	Tap 2	n/a	145	168	201	221	258	279	316	348
	Tap 3	n/a	200	223	265	293	316	359	374	403
	Tap 4	n/a	259	291	309	351	390	429	447	488
"COOL" Speed	Tap 1	n/a	70	89	113	137	155	188	199	233
	Tap 2	n/a	145	168	201	221	258	279	316	348
	Tap 3	n/a	200	223	265	293	316	359	374	403
	Tap 4	n/a	259	291	309	351	390	429	447	488

AT "-" (Minus) SETTING ("Adjust" Jumper at "-" Setting)

Jumper Speed Positions		Motor Watts @ Various External Static Pressures - in. wg.								
		0	0.1	0.2	0.3	0.4	0.5	0.6	0.7	0.8
"HEAT" Speed	Tap 1	n/a	50	78	97	119	144	163	185	199
	Tap 2	n/a	105	130	156	177	212	239	264	280
	Tap 3	n/a	144	167	197	224	255	281	316	340
	Tap 4	n/a	191	229	253	283	310	339	366	398
"COOL" Speed	Tap 1	n/a	50	78	97	119	144	163	185	199
	Tap 2	n/a	105	130	156	177	212	239	264	280
	Tap 3	n/a	144	167	197	224	255	281	316	340
	Tap 4	n/a	191	229	253	283	310	339	366	398

BLOWER DATA

CBA38MV-042 BLOWER PERFORMANCE

0 through 0.80 in. w.g. External Static Pressure Range

"ADJUST" Jumper Setting	Jumper Speed Positions							
	"HEAT" Speed				"COOL" Speed			
	1 cfm	2 cfm	3 cfm	4 cfm	1 cfm	2 cfm	3 cfm	4 cfm
+	1100	1320	1540	1760	1100	1320	1540	1760
NORM	1000	1200	1400	1600	1000	1200	1400	1600
-	900	1080	1260	1440	900	1080	1260	1440

NOTES - The effect of static pressure, filter and electric heater resistance is included in the air volumes listed.

First stage cooling air volume is 70% of COOL speed setting. Continuous fan speed is approximately 28%, 38%, 70% and 100% (Jumper selectable) of the same second-stage COOL speed selected, minimum 450 cfm.

Lennox iHarmony® Zoning System applications - minimum blower speed is 450 cfm.

CBA38MV-042 BLOWER MOTOR WATTS

AT "+" (Plus) SETTING ("Adjust" Jumper at "+" Setting)

Jumper Speed Positions		Motor Watts @ Various External Static Pressures - in. wg.								
		0	0.1	0.2	0.3	0.4	0.5	0.6	0.7	0.8
"HEAT" Speed	Tap 1	NA	121	154	177	199	233	252	283	315
	Tap 2	NA	189	221	247	282	310	344	370	403
	Tap 3	NA	283	312	341	382	422	454	481	515
	Tap 4	NA	407	446	488	528	567	583	646	671
"COOL" Speed	Tap 1	NA	121	154	177	199	233	252	283	315
	Tap 2	NA	189	221	247	282	310	344	370	403
	Tap 3	NA	283	312	341	382	422	454	481	515
	Tap 4	NA	407	446	488	528	567	583	646	671

AT "NORM" SETTING ("Adjust" Jumper at NORM Setting)

Jumper Speed Positions		Motor Watts @ Various External Static Pressures - in. wg.								
		0	0.1	0.2	0.3	0.4	0.5	0.6	0.7	0.8
"HEAT" Speed	Tap 1	NA	104	134	153	184	207	236	257	286
	Tap 2	NA	142	171	203	234	253	298	327	351
	Tap 3	NA	212	240	269	308	337	371	408	429
	Tap 4	NA	309	341	367	406	441	476	516	559
"COOL" Speed	Tap 1	NA	104	134	153	184	207	236	257	286
	Tap 2	NA	142	171	203	234	253	298	327	351
	Tap 3	NA	212	240	269	308	337	371	408	429
	Tap 4	NA	309	341	367	406	441	476	516	559

AT "-" (Minus) SETTING ("Adjust" Jumper at "-" Setting)

Jumper Speed Positions		Motor Watts @ Various External Static Pressures - in. wg.								
		0	0.1	0.2	0.3	0.4	0.5	0.6	0.7	0.8
"HEAT" Speed	Tap 1	NA	78	104	126	155	175	199	209	247
	Tap 2	NA	115	139	168	196	218	247	274	309
	Tap 3	NA	165	192	220	247	290	316	360	376
	Tap 4	NA	237	269	301	327	356	407	430	481
"COOL" Speed	Tap 1	NA	78	104	126	155	175	199	209	247
	Tap 2	NA	115	139	168	196	218	247	274	309
	Tap 3	NA	165	192	220	247	290	316	360	376
	Tap 4	NA	237	269	301	327	356	407	430	481

BLOWER DATA

CBA38MV-048 BLOWER PERFORMANCE

0 through 0.80 in. w.g. External Static Pressure Range

"ADJUST" Jumper Setting	Jumper Speed Positions								
	"HEAT" Speed				"COOL" Speed				
	1	2	3	4	1	2	3	4	
	cfm	cfm	cfm	cfm	cfm	cfm	cfm	cfm	cfm
+	1670	1870	2100	2200	1670	1870	2100	2200	
NORM	1460	1670	1870	2100	1460	1670	1870	2100	
-	1230	1410	1600	1800	1230	1410	1600	1800	

NOTES - The effect of static pressure, filter and electric heater resistance is included in the air volumes listed.

First stage cooling air volume is 70% of COOL speed setting. Continuous fan speed is approximately 28%, 38%, 70% and 100% (Jumper selectable) of the same second-stage COOL speed selected, minimum 450 cfm.

Lennox iHarmony® Zoning System applications - minimum blower speed is 450 cfm.

CBA38MV-048 BLOWER MOTOR WATTS

AT "+" (Plus) SETTING ("Adjust" Jumper at "+" Setting)

Jumper Speed Positions		Motor Watts @ Various External Static Pressures - in. wg.								
		0	0.1	0.2	0.3	0.4	0.5	0.6	0.7	0.8
"HEAT" Speed	Tap 1	NA	335	374	399	436	495	518	572	611
	Tap 2	NA	459	502	537	586	644	689	724	759
	Tap 3	NA	668	738	778	845	881	957	996	1019
	Tap 4	NA	808	865	922	975	1003	1025	1017	987
"COOL" Speed	Tap 1	NA	335	374	399	436	495	518	572	611
	Tap 2	NA	459	502	537	586	644	689	724	759
	Tap 3	NA	668	738	778	845	881	957	996	1019
	Tap 4	NA	808	865	922	975	1003	1025	1017	987

AT "NORM" SETTING ("Adjust" Jumper at NORM Setting)

Jumper Speed Positions		Motor Watts @ Various External Static Pressures - in. wg.								
		0	0.1	0.2	0.3	0.4	0.5	0.6	0.7	0.8
"HEAT" Speed	Tap 1	NA	225	264	289	336	358	396	432	464
	Tap 2	NA	320	374	398	434	484	523	558	610
	Tap 3	NA	451	498	529	583	619	682	721	768
	Tap 4	NA	643	699	731	795	848	919	966	998
"COOL" Speed	Tap 1	NA	225	264	289	336	358	396	432	464
	Tap 2	NA	320	374	398	434	484	523	558	610
	Tap 3	NA	451	498	529	583	619	682	721	768
	Tap 4	NA	643	699	731	795	848	919	966	998

AT "-" (Minus) SETTING ("Adjust" Jumper at "-" Setting)

Jumper Speed Positions		Motor Watts @ Various External Static Pressures - in. wg.								
		0	0.1	0.2	0.3	0.4	0.5	0.6	0.7	0.8
"HEAT" Speed	Tap 1	NA	146	178	207	227	265	299	317	359
	Tap 2	NA	207	243	272	305	345	371	419	438
	Tap 3	NA	290	347	383	412	447	486	525	548
	Tap 4	NA	410	440	491	528	572	613	651	694
"COOL" Speed	Tap 1	NA	146	178	207	227	265	299	317	359
	Tap 2	NA	207	243	272	305	345	371	419	438
	Tap 3	NA	290	347	383	412	447	486	525	548
	Tap 4	NA	410	440	491	528	572	613	651	694

BLOWER DATA

CBA38MV-060 BLOWER PERFORMANCE

0 through 0.80 in. w.g. External Static Pressure Range

"ADJUST" Jumper Setting	Jumper Speed Positions							
	"HEAT" Speed				"COOL" Speed			
	1 cfm	2 cfm	3 cfm	4 cfm	1 cfm	2 cfm	3 cfm	4 cfm
+	1695	1890	2140	2210	1695	1890	2140	2210
NORM	1525	1680	1850	2075	1525	1680	1850	2075
-	1300	1450	1630	1800	1300	1450	1630	1800

NOTES - The effect of static pressure, filter and electric heater resistance is included in the air volumes listed.

First stage cooling air volume is 70% of COOL speed setting. Continuous fan speed is approximately 28%, 38%, 70% and 100% (Jumper selectable) of the same second-stage COOL speed selected, minimum 450 cfm.

Lennox iHarmony® Zoning System applications - minimum blower speed is 450 cfm.

CBA38MV-060 BLOWER MOTOR WATTS

AT "+" (Plus) SETTING ("Adjust" Jumper at "+" Setting)

Jumper Speed Positions		Motor Watts @ Various External Static Pressures - in. wg.								
		0	0.1	0.2	0.3	0.4	0.5	0.6	0.7	0.8
"HEAT" Speed	Tap 1	NA	334	368	412	449	491	532	557	603
	Tap 2	NA	462	511	549	601	640	681	720	762
	Tap 3	NA	670	710	765	820	868	921	963	1005
	Tap 4	NA	757	810	853	909	961	1001	1034	1026
"COOL" Speed	Tap 1	NA	334	368	412	449	491	532	557	603
	Tap 2	NA	462	511	549	601	640	681	720	762
	Tap 3	NA	670	710	765	820	868	921	963	1005
	Tap 4	NA	757	810	853	909	961	1001	1034	1026

AT "NORM" SETTING ("Adjust" Jumper at NORM Setting)

Jumper Speed Positions		Motor Watts @ Various External Static Pressures - in. wg.								
		0	0.1	0.2	0.3	0.4	0.5	0.6	0.7	0.8
"HEAT" Speed	Tap 1	NA	245	285	319	350	398	425	462	497
	Tap 2	NA	330	368	414	443	469	505	558	600
	Tap 3	NA	442	497	515	554	603	643	685	735
	Tap 4	NA	600	653	701	752	798	842	889	935
"COOL" Speed	Tap 1	NA	245	285	319	350	398	425	462	497
	Tap 2	NA	330	368	414	443	469	505	558	600
	Tap 3	NA	442	497	515	554	603	643	685	735
	Tap 4	NA	600	653	701	752	798	842	889	935

AT "-" (Minus) SETTING ("Adjust" Jumper at "-" Setting)

Jumper Speed Positions		Motor Watts @ Various External Static Pressures - in. wg.								
		0	0.1	0.2	0.3	0.4	0.5	0.6	0.7	0.8
"HEAT" Speed	Tap 1	NA	181	204	235	261	304	323	357	383
	Tap 2	NA	218	259	283	315	357	390	422	457
	Tap 3	NA	300	333	365	395	443	476	527	559
	Tap 4	NA	400	430	470	515	543	592	639	678
"COOL" Speed	Tap 1	NA	181	204	235	261	304	323	357	383
	Tap 2	NA	218	259	283	315	357	390	422	457
	Tap 3	NA	300	333	365	395	443	476	527	559
	Tap 4	NA	400	430	470	515	543	592	639	678

ELECTRIC HEAT DATA

CBA38MV-018/024 | SINGLE PHASE

	Model Number	No. of Stages	Volts Input	kW Input	¹ Btuh Input	² Blower Motor Full Load Amps	³ Minimum Circuit Ampacity	⁵ Maximum Overcurrent Protection
4 kW 4 lbs.	ECB38-4 (16V86) Terminal Block ECB38-4CB (16V87) 30A Circuit breaker	1	208	3.0	10,250	3.9	23	⁴ 25
			220	3.4	11,450	4.0	24	⁴ 25
			230	3.7	12,550	4.0	25	⁴ 25
			240	4.0	13,650	4.0	26	30
5 kW 4 lbs.	ECB38-5 (16V88) Terminal Block ECB38-5CB (16V89) 35A Circuit breaker	1	208	3.8	12,800	4.0	28	⁴ 30
			220	4.2	14,300	4.0	29	⁴ 30
			230	4.6	15,700	4.0	30	⁴ 30
			240	5.0	17,100	4.0	31	35
6 kW 4 lbs.	ECB38-6 (16V90) Terminal Block ECB38-6CB (16V91) 40A Circuit breaker	1	208	4.5	15,400	4.0	32	⁴ 35
			220	5.0	17,100	4.0	33	⁴ 35
			230	5.5	18,800	4.0	35	⁴ 35
			240	6.0	20,500	4.0	36	40
8 kW 5 lbs.	ECB38-8 (16V92) Terminal Block ECB38-8CB (16V93) 50A Circuit breaker	2	208	6.0	20,500	4.0	41	⁴ 45
			220	6.7	22,900	4.0	43	⁴ 45
			230	7.3	25,100	4.0	45	⁴ 45
			240	8.0	27,300	4.0	47	50
9 kW 5 lbs.	ECB38-9CB (16V94) 60A Circuit breaker	2	208	6.8	23,100	4.0	46	⁴ 50
			220	7.6	25,800	4.0	48	⁴ 50
			230	8.3	28,200	4.0	50	⁴ 50
			240	9.0	30,700	4.0	52	60

NOTE - Circuit 1 Minimum Circuit Ampacity includes the Blower Motor Full Load Amps.

¹ Electric heater capacity only - does not include additional blower motor heat capacity.

² Amps shown are for blower motor only.

³ Refer to National or Canadian Electrical Code manual to determine wire, fuse and disconnect size requirements. Use wires suitable for at least 167°F.

⁴ Bold text indicates that the circuit breaker on "CB" circuit breaker models must be replaced with size noted. See Replacement Circuit Breakers on page 9.

⁵ HACR type circuit breaker or fuse.

ELECTRIC HEAT DATA

CBA38MV-030 | SINGLE PHASE

Model Number	No. of Stages	Volts Input	kW Input	¹ Btuh Input	² Blower Motor Full Load Amps	³ Minimum Circuit Ampacity		⁵ Maximum Overcurrent Protection		Single Point Power Source	
						Ckt 1	Ckt 2	Ckt 1	Ckt 2	³ Minimum Circuit Ampacity	⁵ Maximum Overcurrent Protection
4 kW 4 lbs. ECB38-4 (16V86) Terminal Block ECB38-4CB (16V87) 30A Circuit breaker	1	208	3.0	10,250	3.9	23	---	425	---	23	25
		220	3.4	11,450	3.9	24	---	425	---	24	25
		230	3.7	12,550	3.9	25	---	425	---	25	25
		240	4.0	13,650	3.9	26	---	30	---	26	30
5 kW 4 lbs. ECB38-5 (16V88) Terminal Block ECB38-5CB (16V89) 35A Circuit breaker	1	208	3.8	12,800	3.9	28	---	430	---	28	30
		220	4.2	14,300	3.9	29	---	430	---	29	30
		230	4.6	15,700	3.9	30	---	430	---	30	30
		240	5.0	17,100	3.9	31	---	35	---	31	35
6 kW 4 lbs. ECB38-6 (16V90) Terminal Block ECB38-6CB (16V91) 40A Circuit breaker	1	208	4.5	15,400	3.9	32	---	435	---	32	35
		220	5.0	17,100	3.9	33	---	435	---	33	35
		230	5.5	18,800	3.9	35	---	435	---	35	35
		240	6.0	20,500	3.9	36	---	40	---	36	40
8 kW 5 lbs. ECB38-8 (16V92) Terminal Block ECB38-8CB (16V93) 50A Circuit breaker	2	208	6.0	20,500	3.9	41	---	445	---	41	45
		220	6.7	22,900	3.9	43	---	445	---	43	45
		230	7.3	25,100	3.9	45	---	445	---	45	45
		240	8.0	27,300	3.9	47	---	50	---	47	50
9 kW 5 lbs. ECB38-9CB (16V94) 60A Circuit breaker	2	208	6.8	23,100	3.9	46	---	450	---	46	50
		220	7.6	25,800	3.9	48	---	450	---	48	50
		230	8.3	28,200	3.9	50	---	450	---	50	50
		240	9.0	30,700	3.9	52	---	60	---	52	60
12.5kW 10 lbs. ECB38-12.5CB (16V95) (1) 30A and (1) 45A Circuit breaker	2	208	9.4	32,000	3.9	24	38	425	440	61	70
		220	10.5	35,800	3.9	25	40	425	440	65	70
		230	11.5	39,200	3.9	26	42	30	45	67	70
		240	12.5	42,600	3.9	27	44	30	45	71	80
15 kW 12 lbs. ECB38-15CB (16V96) (1) 35A and (1) 60A Circuit breaker	2	208	11.3	38,400	3.9	28	45	430	445	72	80
		220	12.6	43,000	3.9	29	48	430	450	76	80
		230	13.8	47,000	3.9	30	50	430	450	80	80
		240	15.0	51,200	3.9	31	52	35	60	83	90

NOTE - Circuit 1 Minimum Circuit Ampacity includes the Blower Motor Full Load Amps.

¹ Electric heater capacity only - does not include additional blower motor heat capacity.

² Amps shown are for blower motor only.

³ Refer to National or Canadian Electrical Code manual to determine wire, fuse and disconnect size requirements. Use wires suitable for at least 167°F.

⁴ Bold text indicates that the circuit breaker on "CB" circuit breaker models must be replaced with size noted. See Replacement Circuit Breakers on page 9.

⁵ HACR type circuit breaker or fuse.

ELECTRIC HEAT DATA

CBA38MV-036 | SINGLE PHASE

Model Number	No. of Stages	Volts Input	kW Input	1 Btuh Input	2 Blower Motor Full Load Amps	3 Minimum Circuit Ampacity		5 Maximum Overcurrent Protection		Single Point Power Source	
						Ckt 1	Ckt 2	Ckt 1	Ckt 2	3 Minimum Circuit Ampacity	5 Maximum Overcurrent Protection
5 kW 4 lbs. ECB38-5 (16V88) Terminal Block ECB38-5CB (16V89) 35A Circuit breaker	1	208	3.8	12,800	5.2	29	---	4 30	---	29	30
		220	4.2	14,300	5.2	30	---	4 30	---	30	35
		230	4.6	15,700	5.2	32	---	35	---	32	35
		240	5.0	17,100	5.2	33	---	35	---	33	35
6 kW 4 lbs. ECB38-6 (16V90) Terminal Block ECB38-6CB (16V91) 40A Circuit breaker	1	208	4.5	15,400	5.2	34	---	4 35	---	34	35
		220	5.0	17,100	5.2	35	---	4 35	---	35	35
		230	5.5	18,800	5.2	36	---	40	---	36	40
		240	6.0	20,500	5.2	38	---	40	---	38	40
8 kW 5 lbs. ECB38-8 (16V92) Terminal Block ECB38-8CB (16V93) 50A Circuit breaker	2	208	6.0	20,500	5.2	43	---	4 45	---	43	45
		220	6.7	22,900	5.2	45	---	4 45	---	45	45
		230	7.3	25,100	5.2	46	---	50	---	46	50
		240	8.0	27,300	5.2	48	---	50	---	48	50
9 kW 5 lbs. ECB38-9CB (16V94) 60A Circuit breaker	2	208	6.8	23,100	5.2	47	---	4 50	---	47	50
		220	7.6	25,800	5.2	50	---	4 50	---	50	50
		230	8.3	28,200	5.2	52	---	60	---	52	60
		240	9.0	30,700	5.2	53	---	60	---	53	60
12.5 kW 10 lbs. ECB38-12.5CB (16V95) (1) 30A and (1) 45A Circuit breaker	2	208	9.4	32,000	5.2	25	38	4 25	4 40	63	70
		220	10.5	35,800	5.2	26	40	30	4 40	66	70
		230	11.5	39,200	5.2	27	42	30	45	69	70
		240	12.5	42,600	5.2	28	44	30	45	72	80
15 kW 12 lbs. ECB38-15CB (16V96) (1) 35A and (1) 60A Circuit breaker	2	208	11.3	38,400	5.2	29	45	4 30	4 45	74	80
		220	12.6	43,000	5.2	30	48	4 30	4 50	78	80
		230	13.8	47,000	5.2	32	50	35	4 50	82	90
		240	15.0	51,200	5.2	33	52	35	60	85	90
20 kW 19 lbs. ECB38-20CB (16V97) (2) 60A Circuit breaker	2	208	15.0	51,200	5.2	47	50	4 50	4 50	97	100
		220	16.8	57,300	5.2	49	53	4 50	60	102	110
		230	18.4	62,700	5.2	51	55	60	60	106	110
		240	20.0	68,200	5.2	53	57	60	60	111	125

NOTE - Circuit 1 Minimum Circuit Ampacity includes the Blower Motor Full Load Amps.

¹ Electric heater capacity only - does not include additional blower motor heat capacity.

² Amps shown are for blower motor only.

³ Refer to National or Canadian Electrical Code manual to determine wire, fuse and disconnect size requirements. Use wires suitable for at least 167°F.

⁴ Bold text indicates that the circuit breaker on "CB" circuit breaker models must be replaced with size noted. See Replacement Circuit Breakers on page 9.

⁵ HACR type circuit breaker or fuse.

ELECTRIC HEAT DATA

CBA38MV-036 | THREE PHASE

Model Number	No. of Stages	Volts Input	kW Input	¹ Btuh Input	² Blower Motor Full Load Amps	³ Minimum Circuit Ampacity		⁵ Maximum Overcurrent Protection		Single Point Power Source		
						Ckt 1	Ckt 2	Ckt 1	Ckt 2	³ Minimum Circuit Ampacity	⁵ Maximum Overcurrent Protection	
						8 kW 5 lbs.	ECB38-8 (16V99) Terminal Block	1	208	6.0	20,500	5.2
		220	6.7	22,900	5.2	29		---	30	---	29	30
		230	7.3	25,100	5.2	30		---	30	---	30	30
		240	8.0	27,300	5.2	30		---	30	---	30	35
10 kW 6 lbs.	ECB38-10 (16W67) Terminal Block	1	208	7.5	25,600	5.2	33	---	35	---	33	35
			220	8.4	28,700	5.2	35	---	35	---	35	35
			230	9.2	31,400	5.2	36	---	40	---	36	40
			240	10.0	34,100	5.2	37	---	40	---	37	40
15 kW 12 lbs.	ECB38-15CB (16W68) 50A Circuit breaker	1	208	11.3	38,400	5.2	46	---	50	---	46	50
			220	12.6	43,000	5.2	48	---	50	---	48	50
			230	13.5	47,000	5.2	50	---	50	---	50	60
			240	15.0	51,200	5.2	52	---	460	---	52	60
20 kW 19 lbs.	ECB38-20CB (16W69) (2) 35A Circuit breaker	2	208	15.0	51,200	5.2	33	26	35	430	59	60
			220	16.8	57,300	5.2	35	28	35	430	62	70
			230	18.4	62,700	5.2	36	29	440	430	65	70
			240	20.0	68,200	5.2	37	30	440	35	67	70

NOTE - Circuit 1 Minimum Circuit Ampacity includes the Blower Motor Full Load Amps.

¹ Electric heater capacity only - does not include additional blower motor heat capacity.

² Amps shown are for blower motor only.

³ Refer to National or Canadian Electrical Code manual to determine wire, fuse and disconnect size requirements. Use wires suitable for at least 167°F.

⁴ Bold text indicates that the circuit breaker on "CB" circuit breaker models must be replaced with size noted. See Replacement Circuit Breakers on page 9.

⁵ HACR type circuit breaker or fuse.

ELECTRIC HEAT DATA

CBA38MV-042 | SINGLE PHASE

kW lbs.	Model Number	No. of Stages	Volts Input	kW Input	1 Btuh Input	2 Blower Motor Full Load Amps	3 Minimum Circuit Ampacity		5 Maximum Overcurrent Protection		Single Point Power Source	
							Ckt 1	Ckt 2	Ckt 1	Ckt 2	3 Minimum Circuit Ampacity	5 Maximum Overcurrent Protection
4 kW 4 lbs.	ECB38-4 (16V86) Terminal Block ECB38-4CB (16V87) 35A Circuit breaker	1	208	3.0	10,250	6.9	27	---	4 30	---	27	30
			220	3.4	11,450	7.4	28	---	4 30	---	28	30
			230	3.7	12,550	7.4	28	---	4 30	---	28	30
			240	4.0	13,650	7.4	29	---	4 30	---	29	30
5 kW 4 lbs.	ECB38-5 (16V88) Terminal Block ECB38-5CB (16V89) 35A Circuit breaker	1	208	3.8	12,800	7.4	31	---	35	---	31	35
			220	4.2	14,300	7.4	32	---	35	---	32	35
			230	4.6	15,700	7.4	34	---	35	---	34	35
			240	5.0	17,100	7.4	35	---	35	---	35	35
6 kW 4 lbs.	ECB38-6 (16V90) Terminal Block ECB38-6CB (16V91) 40A Circuit breaker	1	208	4.5	15,400	7.4	36	---	40	---	36	40
			220	5.0	17,100	7.4	37	---	40	---	37	40
			230	5.5	18,800	7.4	39	---	40	---	39	40
			240	6.0	20,500	7.4	40	---	40	---	40	40
8 kW 5 lbs.	ECB38-8 (16V92) Terminal Block ECB38-8CB (16V93) 50A Circuit breaker	2	208	6.0	20,500	7.4	45	---	4 45	---	45	45
			220	6.7	22,900	7.4	47	---	50	---	47	50
			230	7.3	25,100	7.4	48	---	50	---	48	50
			240	8.0	27,300	7.4	50	---	50	---	50	60
9 kW 5 lbs.	ECB38-9CB (16V94) 60A Circuit breaker	2	208	6.8	23,100	7.4	49	---	4 50	---	49	50
			220	7.6	25,800	7.4	52	---	60	---	52	60
			230	8.3	28,200	7.4	54	---	60	---	54	60
			240	9.0	30,700	7.4	56	---	60	---	56	60
12.5 kW 10 lbs.	ECB38-12.5CB (16V95) (1) 30A and (1) 45A Circuit breaker	2	208	9.4	32,000	7.4	27	38	30	4 40	65	70
			220	10.5	35,800	7.4	29	40	30	4 40	68	70
			230	11.5	39,200	7.4	29	42	30	45	71	80
			240	12.5	42,600	7.4	31	44	4 35	45	74	80
15 kW 12 lbs.	ECB38-15CB (16V96) (1) 35A and (1) 60A Circuit breaker	2	208	11.3	38,400	7.4	31	45	35	4 45	76	80
			220	12.6	43,000	7.4	32	48	35	4 50	80	90
			230	13.5	47,000	7.4	34	50	35	4 50	84	90
			240	15.0	51,200	7.4	35	52	35	60	87	90
20 kW 19 lbs.	ECB38-20CB (16V97) (2) 60A Circuit breaker	2	208	15.0	51,200	7.4	49	50	4 50	4 50	99	100
			220	16.8	57,300	7.4	52	53	60	60	104	110
			230	18.4	62,700	7.4	54	55	60	60	108	110
			240	20.0	68,200	7.4	56	57	60	60	113	125

NOTE - Circuit 1 Minimum Circuit Ampacity includes the Blower Motor Full Load Amps.

¹ Electric heater capacity only - does not include additional blower motor heat capacity.

² Amps shown are for blower motor only.

³ Refer to National or Canadian Electrical Code manual to determine wire, fuse and disconnect size requirements. Use wires suitable for at least 167°F.

⁴ Bold text indicates that the circuit breaker on "CB" circuit breaker models must be replaced with size noted. See Replacement Circuit Breakers on page 9.

⁵ HACR type circuit breaker or fuse.

ELECTRIC HEAT DATA

CBA38MV-042 | THREE PHASE

Model Number	No. of Stages	Volts Input	kW Input	¹ Btuh Input	² Blower Motor Full Load Amps	³ Minimum Circuit Ampacity		⁵ Maximum Overcurrent Protection		Single Point Power Source		
						Ckt 1	Ckt 2	Ckt 1	Ckt 2	³ Minimum Circuit Ampacity	⁵ Maximum Overcurrent Protection	
						8 kW 5 lbs.	ECB38-8 (16V99) Terminal block	1	208	6.0	20,500	7.4
			220	6.7	22,900	7.4	31	---	35	---	31	35
			230	7.3	25,100	7.4	32	---	35	---	32	35
			240	8.0	27,300	7.4	33	---	35	---	33	35
10 kW 6 lbs.	ECB38-10 (16W67) Terminal block	1	208	7.5	25,600	7.4	35	---	40	---	35	40
			220	8.4	28,700	7.4	37	---	40	---	37	40
			230	9.2	31,400	7.4	38	---	40	---	38	40
			240	10.0	34,100	7.4	39	---	40	---	39	40
15 kW 12 lbs.	ECB38-15CB (16W68) 50A Circuit breaker	1	208	11.3	38,400	7.4	48	---	50	---	48	50
			220	12.6	43,000	7.4	51	---	460	---	51	60
			230	13.5	47,000	7.4	52	---	460	---	52	60
			240	15.0	51,200	7.4	54	---	460	---	54	60
20 kW 19 lbs.	ECB38-20CB (16W69) (2) 35A Circuit breaker	2	208	15.0	51,200	7.4	35	26	440	430	61	70
			220	16.8	57,300	7.4	37	28	440	430	64	70
			230	18.4	62,700	7.4	38	29	440	430	67	70
			240	20.0	68,200	7.4	39	30	440	35	69	70

NOTE - Circuit 1 Minimum Circuit Ampacity includes the Blower Motor Full Load Amps.

¹ Electric heater capacity only - does not include additional blower motor heat capacity.

² Amps shown are for blower motor only.

³ Refer to National or Canadian Electrical Code manual to determine wire, fuse and disconnect size requirements. Use wires suitable for at least 167°F.

⁴ Bold text indicates that the circuit breaker on "CB" circuit breaker models must be replaced with size noted. See Replacement Circuit Breakers on page 9.

⁵ HACR type circuit breaker or fuse.

ELECTRIC HEAT DATA

CBA38MV-048 AND CBA38MV-060 | SINGLE PHASE

Model Number	No. of Stages	Volts Input	kW Input	¹ Btuh Input	² Blower Motor Full Load Amps	³ Minimum Circuit Ampacity			⁵ Maximum Overcurrent Protection			Single Point Power Source	
						Ckt 1	Ckt 2	Ckt 3	Ckt 1	Ckt 2	Ckt 3	³ Minimum Circuit Ampacity	⁵ Maximum Overcurrent Protection
4 kW 4 lbs. ECB38-4 (16V86) Terminal Block ECB38-4CB (16V87) 35A Circuit breaker	1	208	3.0	10,250	6.9	27	---	---	⁴30	---	---	27	30
		220	3.4	11,450	6.9	28	---	---	⁴30	---	---	28	30
		230	3.7	12,550	6.9	28	---	---	⁴30	---	---	28	30
		240	4.0	13,650	6.9	29	---	---	⁴30	---	---	29	30
5 kW 4 lbs. ECB38-5 (16V88) Terminal Block ECB38-5CB (16V89) 35A Circuit breaker	1	208	3.8	12,800	6.9	31	---	---	35	---	---	31	35
		220	4.2	14,300	6.9	32	---	---	35	---	---	32	35
		230	4.6	15,700	6.9	34	---	---	35	---	---	34	35
		240	5.0	17,100	6.9	35	---	---	35	---	---	35	35
6 kW 4 lbs. ECB38-6 (16V90) Terminal Block ECB38-6CB (16V91) 40A Circuit breaker	1	208	4.5	15,400	6.9	36	---	---	40	---	---	36	40
		220	5.0	17,100	6.9	37	---	---	40	---	---	37	40
		230	5.5	18,800	6.9	39	---	---	40	---	---	39	40
		240	6.0	20,500	6.9	40	---	---	40	---	---	40	40
8 kW 5 lbs. ECB38-8 (16V92) Terminal Block ECB38-8CB (16V93) 50A Circuit breaker	2	208	6.0	20,500	6.9	45	---	---	⁴45	---	---	45	45
		220	6.7	22,900	6.9	47	---	---	50	---	---	47	50
		230	7.3	25,100	6.9	48	---	---	50	---	---	48	50
		240	8.0	27,300	6.9	50	---	---	50	---	---	50	60
9 kW 5 lbs. ECB38-9CB (16V94) 60A Circuit breaker	2	208	6.8	23,100	6.9	49	---	---	⁴50	---	---	49	50
		220	7.6	25,800	6.9	52	---	---	60	---	---	52	60
		230	8.3	28,200	6.9	54	---	---	60	---	---	54	60
		240	9.0	30,700	6.9	56	---	---	60	---	---	56	60
12.5 kW 10 lbs. ECB38-12.5CB (16V95) (1) 30A and (1) 45A Circuit breaker	2	208	9.4	32,000	6.9	27	38	---	30	⁴40	---	65	70
		220	10.5	35,800	6.9	29	40	---	30	⁴40	---	68	70
		230	11.5	39,200	6.9	29	42	---	30	45	---	71	80
		240	12.5	42,600	6.9	31	44	---	⁴35	45	---	74	80
15 kW 12 lbs. ECB38-15CB (16V96) (1) 35A and (1) 60A Circuit breaker	2	208	11.3	38,400	6.9	31	45	---	35	⁴45	---	76	80
		220	12.6	43,000	6.9	32	48	---	35	⁴50	---	80	90
		230	13.5	47,000	6.9	34	50	---	35	⁴50	---	84	90
		240	15.0	51,200	6.9	35	52	---	35	60	---	87	90
20 kW 19 lbs. ECB38-20CB (16V97) (2) 60A Circuit breaker	2	208	15.0	51,200	6.9	49	50	---	⁴50	⁴50	---	99	100
		220	16.8	57,300	6.9	52	53	---	60	60	---	104	110
		230	18.4	62,700	6.9	54	55	---	60	60	---	108	110
		240	20.0	68,200	6.9	56	57	---	60	60	---	113	125
25 kW 19 lbs. ECB38-25CB (16V98) (1) 60A and (2) 45A Circuit breaker	3	208	18.8	64,100	6.9	46	38	38	⁴50	⁴40	⁴40	122	125
		220	21.0	71,700	6.9	48	40	40	⁴50	⁴40	⁴40	128	150
		230	23.0	78,300	6.9	50	42	42	⁴50	45	45	134	150
		240	25.0	85,300	6.9	52	44	44	60	45	45	140	150

NOTE - Circuit 1 Minimum Circuit Ampacity includes the Blower Motor Full Load Amps.

¹ Electric heater capacity only - does not include additional blower motor heat capacity.

² Amps shown are for blower motor only.

³ Refer to National or Canadian Electrical Code manual to determine wire, fuse and disconnect size requirements. Use wires suitable for at least 167°F.

⁴ Bold text indicates that the circuit breaker on "CB" circuit breaker models must be replaced with size noted. See Replacement Circuit Breakers on page 9.

⁵ HACR type circuit breaker or fuse.

ELECTRIC HEAT DATA

CBA38MV-048 AND CBA38MV-060 | THREE PHASE

Model Number	No. of Stages	Volts Input	kW Input	¹ Btuh Input	² Blower Motor Full Load Amps	³ Minimum Circuit Ampacity		⁵ Maximum Overcurrent Protection		Single Point Power Source	
						Ckt 1	Ckt 2	Ckt 1	Ckt 2	³ Minimum Circuit Ampacity	⁵ Maximum Overcurrent Protection
8 kW 5 lbs. ECB38-8 (16V99) Terminal block	1	208	6.0	20,500	6.9	30	---	35	---	30	35
		220	6.7	22,900	6.9	31	---	35	---	31	35
		230	7.3	25,100	6.9	32	---	35	---	32	35
		240	8.0	27,300	6.9	33	---	35	---	33	35
10 kW 6 lbs. ECB38-10 (16W67) Terminal block	1	208	7.5	25,600	6.9	35	---	40	---	35	40
		220	8.4	28,700	6.9	37	---	40	---	37	40
		230	9.2	31,400	6.9	38	---	40	---	38	40
		240	10.0	34,100	6.9	39	---	40	---	39	40
15 kW 12 lbs. ECB38-15CB (16W68) 50A Circuit breaker	1	208	11.3	38,400	6.9	48	---	50	---	48	50
		220	12.6	43,000	6.9	51	---	460	---	51	60
		230	13.5	47,000	6.9	52	---	460	---	52	60
		240	15.0	51,200	6.9	54	---	460	---	54	60
20 kW 19 lbs. ECB38-20CB (16W69) (2) 35A Circuit breaker	2	208	15.0	51,200	6.9	35	26	440	430	61	70
		220	16.8	57,300	6.9	37	28	440	430	64	70
		230	18.4	62,700	6.9	38	29	440	430	67	70
		240	20.0	68,200	6.9	39	30	440	35	69	70
25 kW 19 lbs. ECB38-25CB (16W70) (1) 50A and (1) 40A Circuit breaker	2	208	18.8	64,100	6.9	42	33	445	435	74	80
		220	21.0	71,700	6.9	44	34	445	435	78	80
		230	23.0	78,300	6.9	45	36	50	40	81	90
		240	25.0	85,300	6.9	47	38	50	40	84	90

NOTE - Circuit 1 Minimum Circuit Ampacity includes the Blower Motor Full Load Amps.

¹ Electric heater capacity only - does not include additional blower motor heat capacity.

² Amps shown are for blower motor only.

³ Refer to National or Canadian Electrical Code manual to determine wire, fuse and disconnect size requirements. Use wires suitable for at least 167°F.

⁴ Bold text indicates that the circuit breaker on "CB" circuit breaker models must be replaced with size noted. See Replacement Circuit Breakers on page 9.

⁵ HACR type circuit breaker or fuse.

UPFLOW POSITION

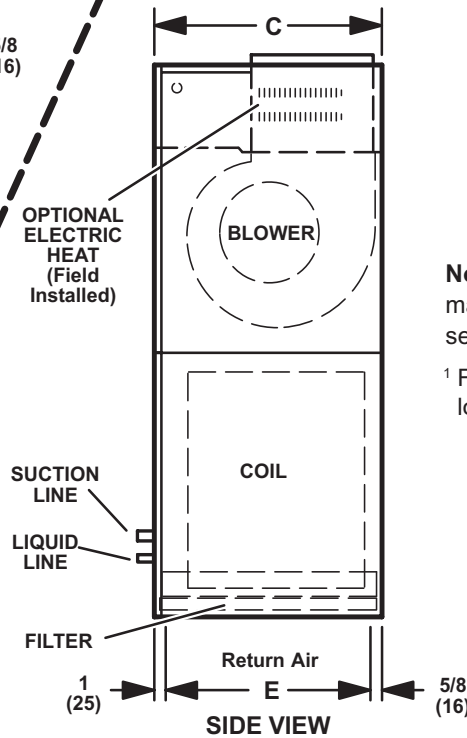
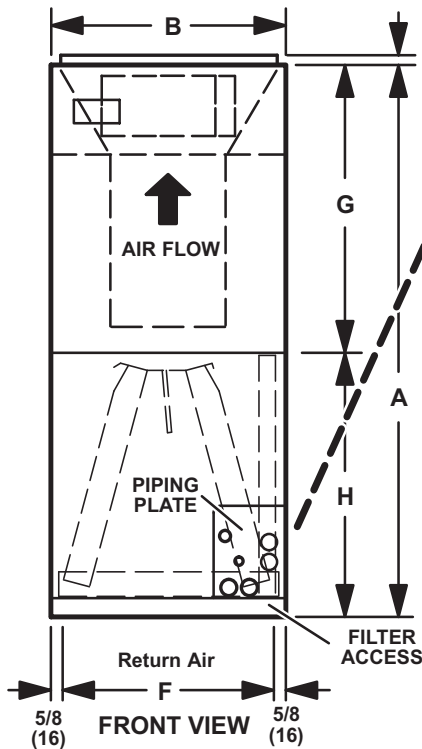
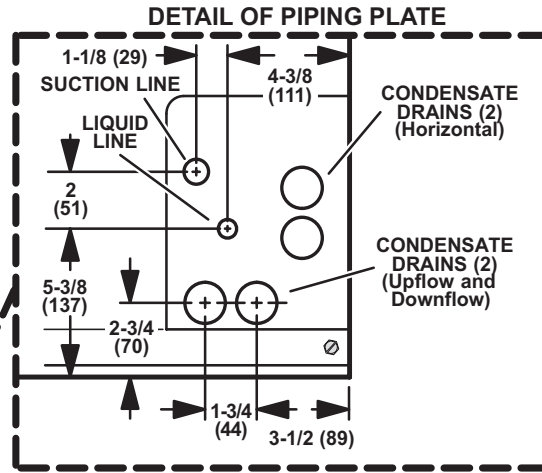
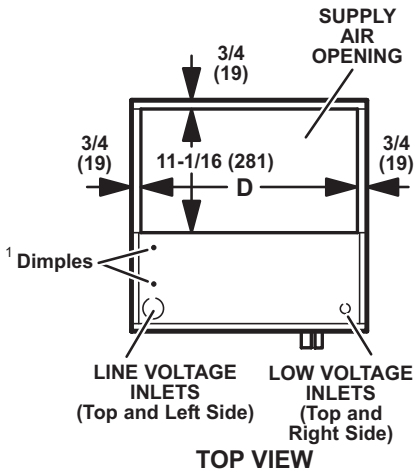

Note - Units are shipped in one piece but may be disassembled into two separate sections for ease of installation.

¹ For additional circuits, use the dimples to locate the new knockouts.

Model No.	A		B		C		D		E		F		G		H	
	in	mm	in	mm	in	mm	in	mm	in	mm	in	mm	in	mm	in	mm
CBA38MV-018/024	49-1/4	1251	21-1/4	540	20-5/8	524	19-3/4	502	19	483	20	508	24-5/8	625	24-5/8	625
CBA38MV-030 CBA38MV-036	51	1295	21-1/4	540	22-5/8	575	19-3/4	502	21	533	20	508	26-3/8	670	24-5/8	625
CBA38MV-042 CBA38MV-048	58-1/2	1486	21-1/4	540	24-5/8	625	19-3/4	502	23	584	20	508	27-7/8	708	30-5/8	778
CBA38MV-060	62-1/2	1588	21-1/4	540	24-5/8	625	19-3/4	502	23	584	20	508	27-7/8	708	34-5/8	879

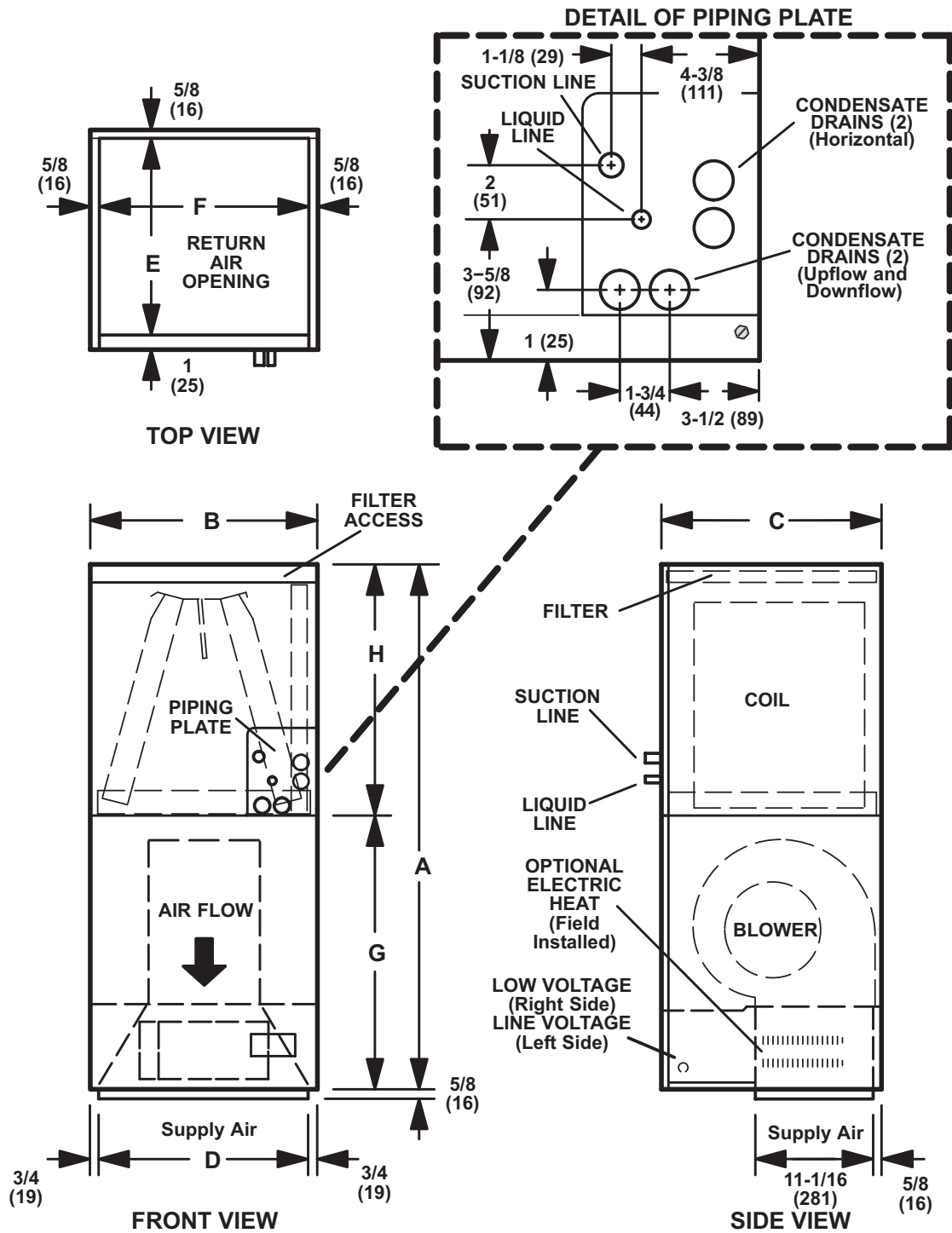

Note - Units are shipped in one piece but may be disassembled into two separate sections for ease of installation.

Model No.	A		B		C		D		E		F		G		H	
	in	mm	in	mm	in	mm	in	mm	in	mm	in	mm	in	mm	in	mm
CBA38MV-018/024	49-1/4	1251	21-1/4	540	20-5/8	524	19-3/4	502	19	483	20	508	24-5/8	625	24-5/8	625
CBA38MV-030 CBA38MV-036	51	1295	21-1/4	540	22-5/8	575	19-3/4	502	21	533	20	508	26-3/8	670	24-5/8	625
CBA38MV-042 CBA38MV-048	58-1/2	1486	21-1/4	540	24-5/8	625	19-3/4	502	23	584	20	508	27-7/8	708	30-5/8	778
CBA38MV-060	62-1/2	1588	21-1/4	540	24-5/8	625	19-3/4	502	23	584	20	508	27-7/8	708	34-5/8	879

RIGHT-HAND AIR DISCHARGE

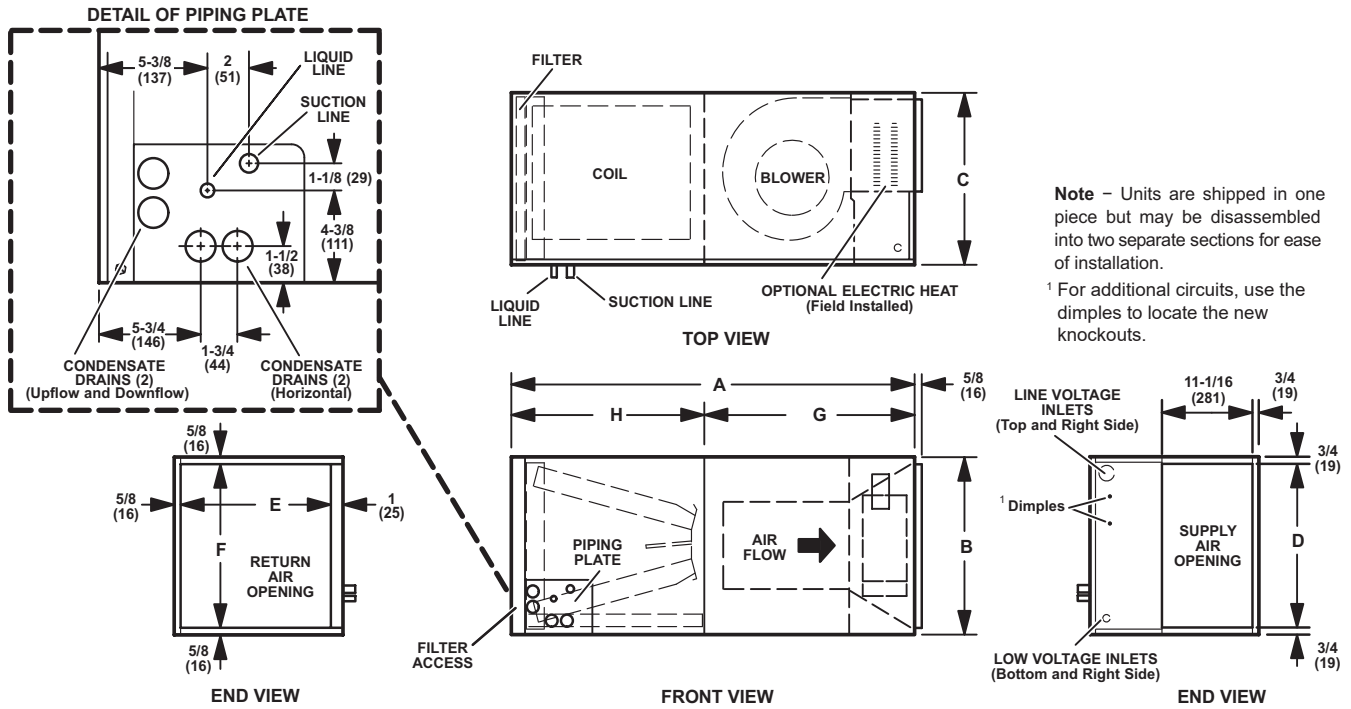

Note - Units are shipped in one piece but may be disassembled into two separate sections for ease of installation.
¹ For additional circuits, use the dimples to locate the new knockouts.

LEFT-HAND AIR DISCHARGE

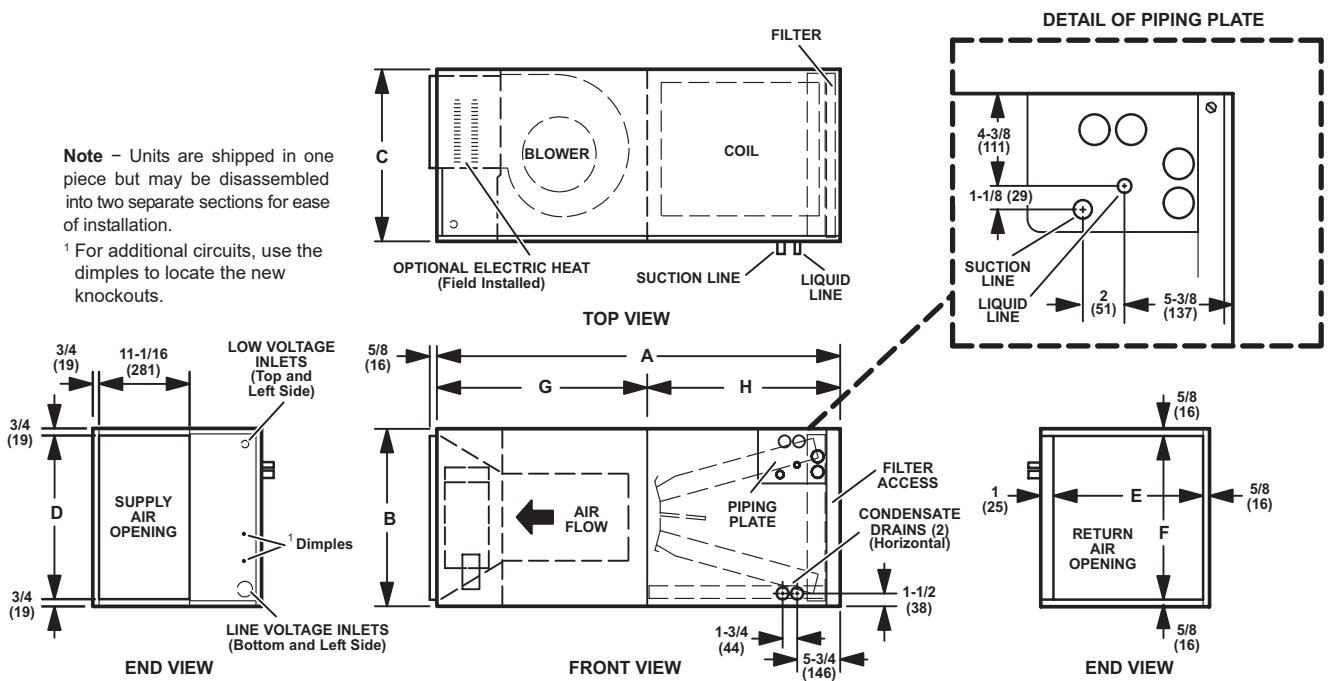

Note - Units are shipped in one piece but may be disassembled into two separate sections for ease of installation.
¹ For additional circuits, use the dimples to locate the new knockouts.

Model No.	A		B		C		D		E		F		G		H	
	in	mm	in	mm	in	mm	in	mm	in	mm	in	mm	in	mm	in	mm
CBA38MV-018/024	49-1/4	1251	21-1/4	540	20-5/8	524	19-3/4	502	19	483	20	508	24-5/8	625	24-5/8	625
CBA38MV-030 CBA38MV-036	51	1295	21-1/4	540	22-5/8	575	19-3/4	502	21	533	20	508	26-3/8	670	24-5/8	625
CBA38MV-042 CBA38MV-048	58-1/2	1486	21-1/4	540	24-5/8	625	19-3/4	502	23	584	20	508	27-7/8	708	30-5/8	778
CBA38MV-060	62-1/2	1588	21-1/4	540	24-5/8	625	19-3/4	502	23	584	20	508	27-7/8	708	34-5/8	879

AIR FLOW

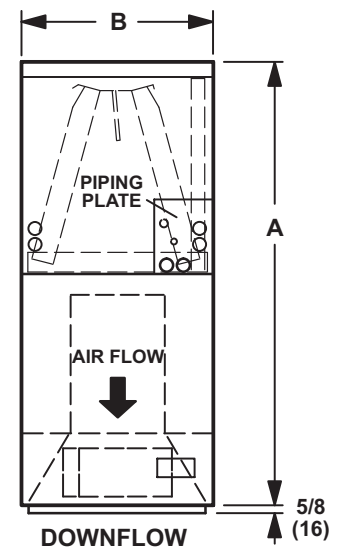
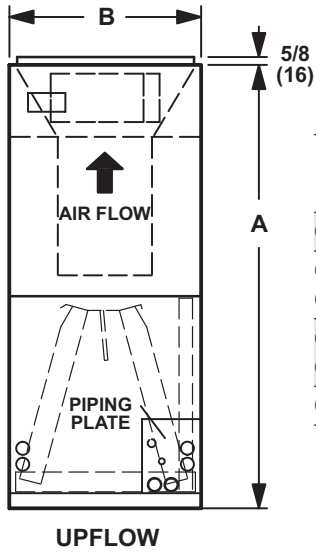
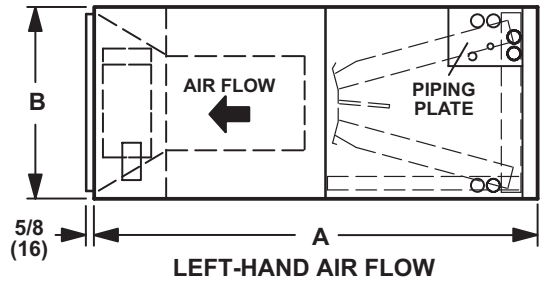
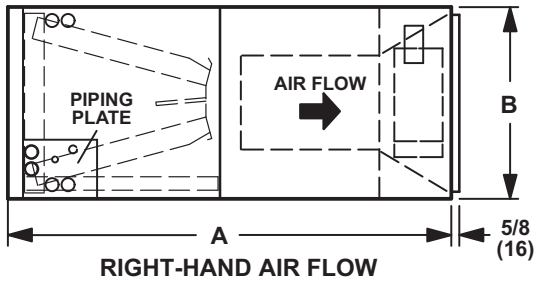

Model No.	A		B	
	in.	mm	in.	mm
CBA38MV-018/024	49-1/4	1251	21-1/4	540
CBA38MV-030	51	1295	21-1/4	540
CBA38MV-036				
CBA38MV-042	58-1/2	1486	21-1/4	540
CBA38MV-048				
CBA38MV-060	62-1/2	1588	21-1/4	540

DOWNFLOW COMBUSTIBLE FLOORING BASE

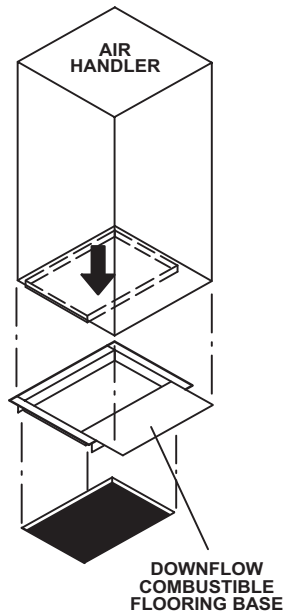

Catalog No. - 44K15

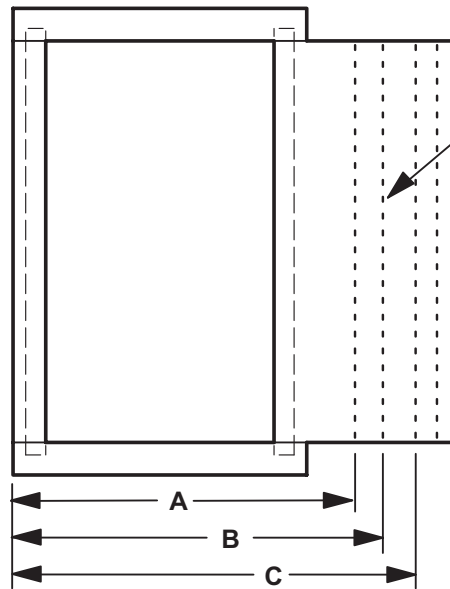
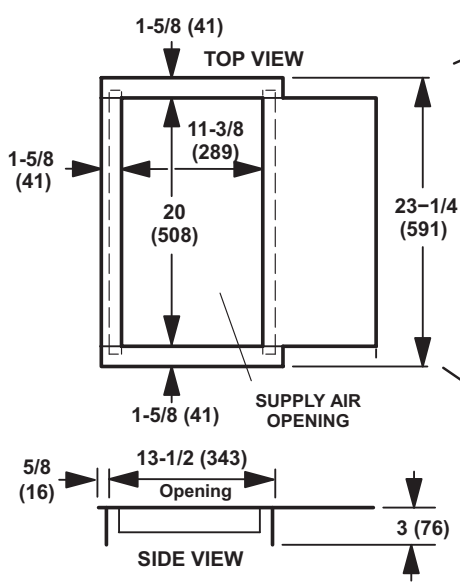

Break off extended width at pre-perforated line to fit specific air handler application.
NOTE - Width of base includes an additional 2 in. (51 mm) for air handler positioning adjustment.

Model No.	018/024		030, 036		042, 048, 060	
	in.	mm	in.	mm	in.	mm
A	22-5/8	575	---	---	---	---
B	---	---	24-5/8	625	---	---
C	---	---	---	---	26-5/8	676

REVISIONS

Sections	Description of Change
Optional Accessories	Updated catalog numbers for S30 thermostat.



Visit us at www.Lennox.com

For the latest technical information, www.LennoxPros.com

Contact us at 1-800-4-LENNOX

NOTE - Due to Lennox' ongoing commitment to quality, Specifications, Ratings and Dimensions subject to change without notice and without incurring liability. Improper installation, adjustment, alteration, service or maintenance can cause property damage or personal injury. Installation and service must be performed by a qualified installer and servicing agency.

©2020 Lennox Industries, Inc.