



# SUBMITTAL DATA – WALL MOUNTED

## MHA018S4S-1P – MWHA018S4-1P

### SINGLE ZONE MINI-SPLIT HEAT PUMP

Job: \_\_\_\_\_  
 Location: \_\_\_\_\_  
 Schedule No.: \_\_\_\_\_  
 System Designation: \_\_\_\_\_

Engineer: \_\_\_\_\_  
 Architect: \_\_\_\_\_  
 Date: \_\_\_\_\_  
 For:  Reference  Approval  Review  Construction

## FEATURES

### Outdoor Unit: MHA018S4S-1P



- DC Inverter Control
- Compressor Overcurrent Protection
- Defrost Control

### Indoor Unit: MWHA018S4-1P



- Pre-Heat Function
- Auto Restart
- Three Speed Fan
- Flare Connections
- Multi-Refrigerant Outlet
- LED Readout
- Wireless Remote Included

## PIPING

Line Set and Elevation Guidelines	
Maximum Line Set Length ft. (m)	98 (30)
Maximum Elevation - Outdoor Unit Below/Above Indoor Unit ft. (m)	66 (20)
Liquid Line Set Diameter (in.)	1/4
Gas Line Set Diameter (in.)	1/2
Pre-Charged (ft.)	25
Additional Charge Per Ft. (oz.)	0.161

## PRODUCT WARRANTY

Compressor – Seven year limited warranty  
 All other covered components - Five year limited warranty

## OPTIONAL ACCESSORIES

Non-Programmable Controller (M0STAT61Q-1)  
 Programmable Controller (M0STAT64Q-1)  
 Hail Guards (M9GARD14Q-1)



NOTE – Due to Lennox' ongoing commitment to quality, Specifications, Ratings, and Dimensions are subject to change without notice and without incurring liability. Improper installation, adjustment, alteration, service or maintenance can cause property damage or personal injury. Installation and service must be performed by a qualified installer and servicing agency.



# SUBMITTAL DATA - WALL MOUNTED

## MHA018S4S-1P - MWHA018S4-1P

### SINGLE ZONE MINI-SPLIT HEAT PUMP

#### OUTDOOR SPECIFICATIONS

PERFORMANCE		GENERAL DATA	
Cooling Capacity (Btu/h) <sup>1</sup>	18,000	Connection Ratio (%)	100%
EER	11	Max. # of Indoor Units	1 unit
SEER	19	Sound Data (dBA)	57.5
Heating Capacity (Btu/h) <sup>1</sup>	18,000	Refrigerant type	R-410A
HSPF	10	Factory refrigerant charge	2 lbs. 12 oz.
Outdoor Fan Total Air Volume (CFM)	1,175	DIMENSIONS	
Ambient Temperature Operating Range		Unit Dimensions (in)	Height 21-7/8
Cooling	5°F - 122°F		Width 31-1/2
Heating	5°F - 86°F		Depth 13-3/8
ELECTRICAL DATA		Shipping Weight (lb)	86
Power Supply (V/Hz/Φ)	208-230/60/1	Net Weight (lb)	80
Minimum Circuit Ampacity (A)	15	NOTES	
Maximum Overcurrent Protection (A)	20	1. Cooling and Heating Capacity data is rated at the following conditions:	
Outdoor Fan Motor RLA (A)	0.5	Cooling: 80°FDB / 67°FWB Indoor, 95°FDB Outdoor	
Compressor RLA (A)	10	Heating: 70°FDB Indoor, 47°FDB / 43°FWB Outdoor	
No. of Compressors	1		

#### OUTDOOR DIMENSIONAL DRAWINGS - INCHES (MM)

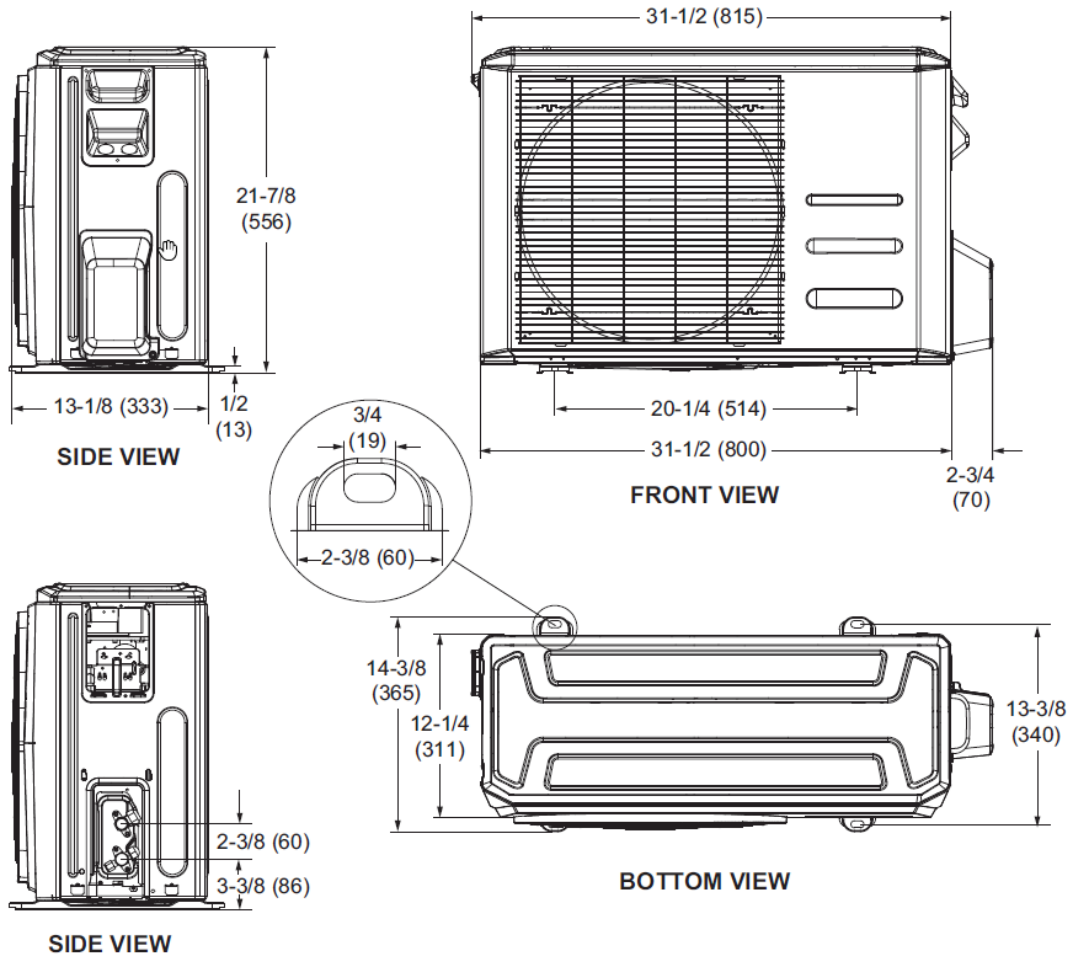

NOTE - Due to Lennox' ongoing commitment to quality, Specifications, Ratings, and Dimensions are subject to change without notice and without incurring liability. Improper installation, adjustment, alteration, service or maintenance can cause property damage or personal injury. Installation and service must be performed by a qualified installer and servicing agency.



## SUBMITTAL DATA - WALL-MOUNTED

### MHA018S4S-1P - MWHA018S4-1P

### SINGLE ZONE MINI-SPLIT HEAT PUMP

#### INDOOR SPECIFICATIONS

##### PERFORMANCE

Airflow (CFM)	High	449
	Medium	393
	Low	262
Sound Pressure (dBA)	High	43
	Medium	35
	Low	30.5

##### ELECTRICAL DATA

Power Supply (V/Hz/Φ)	Supplied by ODU	
Rated load amps (RLA)	0.11	
Power Output (W)	30	

##### DIMENSIONS

Unit Dimensions (in)	Height	12-1/2
	Width	39-1/8
	Depth	9-7/8

Unit Net/Shipping Weight (lb)	25/33
-------------------------------	-------

##### PIPING

Liquid/Gas O.D. Flare (in.)	1/4 , 1/2
Drain Connection O.D. (in.)	1

#### WIRELESS REMOTE CONTROLLER SPECIFICATIONS

##### M0STAT60Q-1

Power Supply	2 AAA Batteries (Included)
Setpoint Range	62°F - 86°F
Operating Temperature Range	23°F - 140°F
Operating Humidity Range (RH)	40% to 90%
Effective Receiving Range	25 ft.

#### DISPLAY

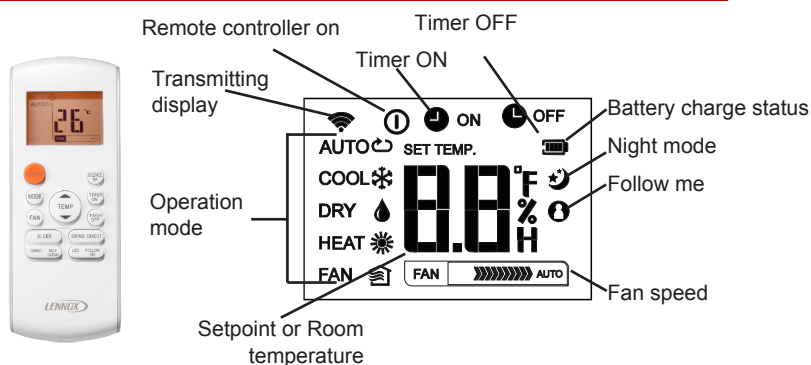

#### INDOOR DIMENSIONAL DRAWINGS - INCHES (MM)

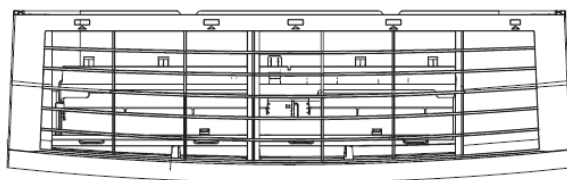

TOP VIEW

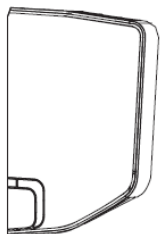

SIDE VIEW

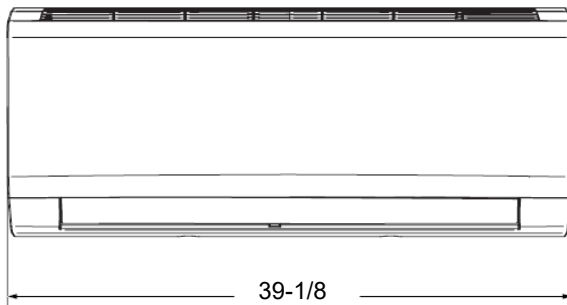

FRONT VIEW

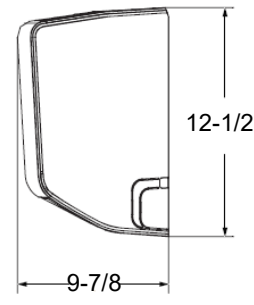

SIDE VIEW

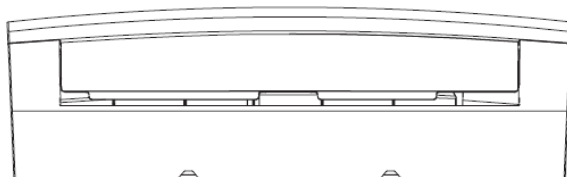

BOTTOM VIEW

NOTE - Due to Lennox' ongoing commitment to quality, Specifications, Ratings, and Dimensions are subject to change without notice and without incurring liability. Improper installation, adjustment, alteration, service or maintenance can cause property damage or personal injury. Installation and service must be performed by a qualified installer and servicing agency.