



SUBMITTAL DATA - WALL-MOUNTED 3PB036S4S-1P - 3WMB036S4-1P SINGLE-ZONE MINI-SPLIT HEAT PUMP

Job: _____
 Location: _____
 Schedule No.: _____
 System Designation: _____

Engineer: _____
 Architect: _____
 Date: _____
 For: Reference Approval Review Construction

FEATURES

3PB036S4S-1P

- DC Inverter Control
- Compressor Overcurrent Protection
- Defrost Control

3WMB036S4-1P

- Pre Heat Function
- Multi-Refrigerant Outlet
- Flare Connections
- Refrigerant R-410A
- Auto Restart
- Cooling Override
- LED Display
- Wireless Remote Controller included

Product Warranty

Compressor – Twelve year limited warranty.
 All other covered components – Twelve year limited warranty.
 Product registration required.

OUTDOOR SPECIFICATIONS

PERFORMANCE

Cooling Capacity (Btu/h) ¹	36,000
EER	8.6
SEER	16.0
Heating Capacity (Btu/h) ¹	36,000
HSPF	8.5
Outdoor Fan Total Air Volume (cfm)	2130
Ambient Temperature Operating Range	
Cooling	-5°F to 122°F
Heating	-5°F to 86°F

ELECTRICAL DATA

Power Supply (V/Hz/Ph)	208-230/60/1
Minimum Circuit Ampacity (A)	25
Maximum Overcurrent Protection (A)	35
Outdoor Fan Motor RLA (A)	0.6
Compressor RLA (A)	17.0
No. of Compressors	1

GENERAL DATA

Connection Ratio (%)	100%
Max. # of Indoor Units	1 unit
Sound Data (dBA) - Cooling/Heating	59 / 59
Refrigerant type	R-410A
Factory refrigerant charge	7 lbs. 8 oz.

DIMENSIONS

Unit Dimensions (in)	Height	31-7/8
	Width	37-1/4
	Depth	15-7/8
Shipping Weight (lb)		158
Net Weight (lb)		146

OPTIONAL ACCESSORIES

Non-Programmable Controller (M0STAT61Q-1):	
Wireless Remote Controller (M0STAT60Q-1):	1+
Programmable Controller (M0STAT64Q-1):	

INDOOR SPECIFICATIONS

PERFORMANCE

Airflow (CFM)	High	795
	Medium	645
	Low	500
External Static Pressure (in. w.g.)		-
Sound Pressure (dBA)	High	48.5
	Medium	44.0
	Low	38.0

ELECTRICAL DATA

Power Supply (V/Hz/Φ)	Supplied by ODU
Rated load amps (RLA)	0.5
Power Output (W)	60

DIMENSIONS

Unit Dimensions (in)	Height	13-1/2
	Width	46-3/4
	Depth	10-1/4
Liquid Pipe Connection (in)		3/8
Gas Pipe Connection (in)		5/8
Condensate drain connection (in)		0.69
Unit Shipping Weight (lb)		50
Unit Net Weight (lb)		40

NOTES

- Cooling and Heating Capacity data is rated at the following conditions:
 Cooling: 80°FDB / 67°FWB Indoor, 95°FWB / 75°FDB Outdoor
 Heating: 70°FDB / 60°FWB Indoor, 47°FDB / 43°FWB Outdoor



NOTE – Due to Lennox' ongoing commitment to quality, Specifications, Ratings and Dimensions subject to change without notice and without incurring liability. Improper installation, adjustment, alteration, service or maintenance can cause property damage or personal injury. Installation and service must be performed by a qualified installer and servicing agency.



SUBMITTAL DATA - WALL-MOUNTED
3PB036S4S-1P - 3WMB036S4-1P
SINGLE-ZONE MINI-SPLIT HEAT PUMP

OUTDOOR DIMENSIONAL DRAWINGS - INCHES (MM)

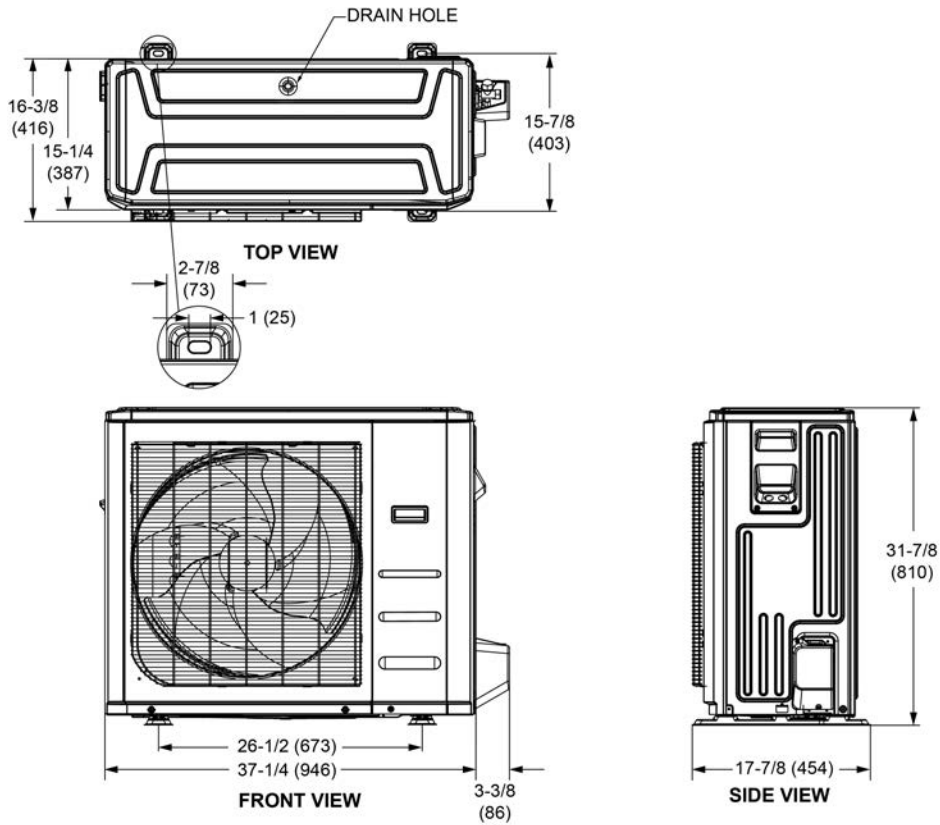

INDOOR DIMENSIONAL DRAWINGS - INCHES (MM)

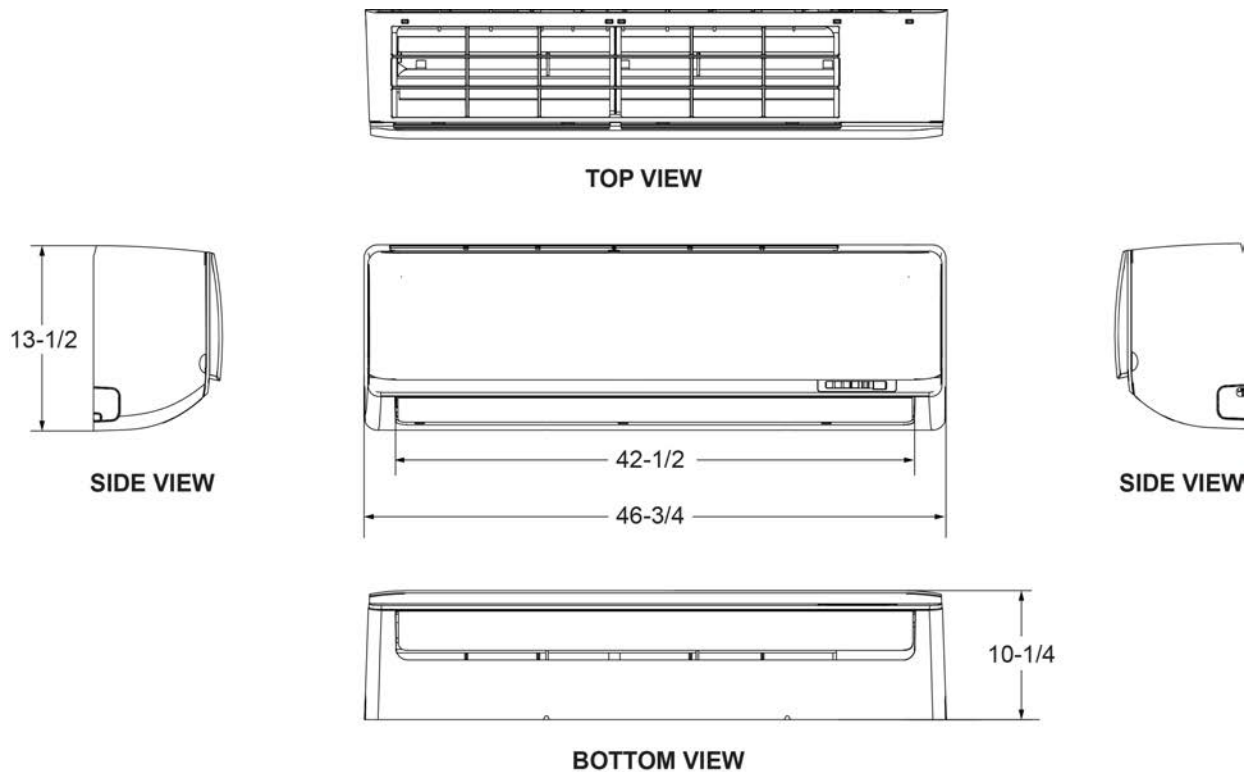

NOTE – Due to Lennox' ongoing commitment to quality, Specifications, Ratings and Dimensions subject to change without notice and without incurring liability. Improper installation, adjustment, alteration, service or maintenance can cause property damage or personal injury. Installation and service must be performed by a qualified installer and servicing agency.