



SUBMITTAL DATA - **WALL-MOUNTED** **MPB009S4S-1P - MWMA009S4-2P** **SINGLE-ZONE MINI-SPLIT HEAT PUMP**

Job: _____
Location: _____
Schedule No.: _____
System Designation: _____

Engineer: _____
Architect: _____
Date: _____
For: Reference Approval Review Construction

FEATURES

MPB009S4S-1P

- DC Inverter Control
- Compressor Overcurrent Protection
- Defrost Control

MWMA009S4-2P

- Pre Heat Function
- Multi-Refrigerant Outlet
- Flare Connections
- Refrigerant R-410A
- Auto Restart
- Cooling Override
- LED Display
- Wireless Remote Controller included

Product Warranty

Compressor – Twelve year limited warranty.
All other covered components – Twelve year limited warranty.
Product registration required.

OUTDOOR SPECIFICATIONS

PERFORMANCE

Cooling Capacity (Btu/h) ¹	9,000
EER	14.90
SEER	23.50
Heating Capacity (Btu/h) ¹	9,800
HSPF	10.80
Outdoor Fan Total Air Volume (cfm)	1200
Ambient Temperature Operating Range	
Cooling	-13°F to 122°F
Heating	-13°F to 86°F

ELECTRICAL DATA

Power Supply (V/Hz/Ph)	208-230/60/1
Minimum Circuit Ampacity (A)	10
Maximum Overcurrent Protection (A)	15
Outdoor Fan Motor RLA (A)	0.4
Compressor RLA (A)	5.5
No. of Compressors	1

GENERAL DATA

Connection Ratio (%)	100%
Max. # of Indoor Units	1 unit
Sound Data (dBA) - Cooling/Heating	55 / 55
Refrigerant type	R-410A
Factory refrigerant charge	2 lbs. 7 oz.

DIMENSIONS

Unit Dimensions (in)	Height	21-7/8
	Width	31-1/2
	Depth	13-3/8
Shipping Weight (lb)		67
Net Weight (lb)		62

OPTIONAL ACCESSORIES

Non-Programmable Controller (M0STAT61Q-1):	
Wireless Remote Controller (M0STAT60Q-1):	1+
Programmable Controller (M0STAT64Q-1):	

INDOOR SPECIFICATIONS

PERFORMANCE

Airflow (CFM)	High	370
	Medium	270
	Low	195
External Static Pressure (in. w.g.)		-
Sound Pressure (dBA)	High	41.7
	Medium	33.4
	Low	26.5

ELECTRICAL DATA

Power Supply (V/Hz/Φ)	Supplied by ODU
Rated load amps (RLA)	0.06
Power Output (W)	20

DIMENSIONS

Unit Dimensions (in)	Height	11
	Width	32-7/8
	Depth	7-7/8
Liquid Pipe Connection (in)		1/4
Gas Pipe Connection (in)		3/8
Condensate drain connection (in)		1
Unit Shipping Weight (lb)		26
Unit Net Weight (lb)		20

NOTES

1. Cooling and Heating Capacity data is rated at the following conditions:

Cooling: 80°FDB / 67°FWB Indoor, 95°FWB / 75°FDB Outdoor

Heating: 70°FDB / 60°FWB Indoor, 47°FDB / 43°FWB Outdoor



NOTE – Due to Lennox' ongoing commitment to quality, Specifications, Ratings and Dimensions subject to change without notice and without incurring liability. Improper installation, adjustment, alteration, service or maintenance can cause property damage or personal injury. Installation and service must be performed by a qualified installer and servicing agency.

495541 (201702)

©2017 Lennox Industries Inc.



**SUBMITTAL DATA - WALL-MOUNTED
MPB009S4S-1P - MWMA009S4-2P
SINGLE-ZONE MINI-SPLIT HEAT PUMP**

OUTDOOR DIMENSIONAL DRAWINGS - INCHES (MM)

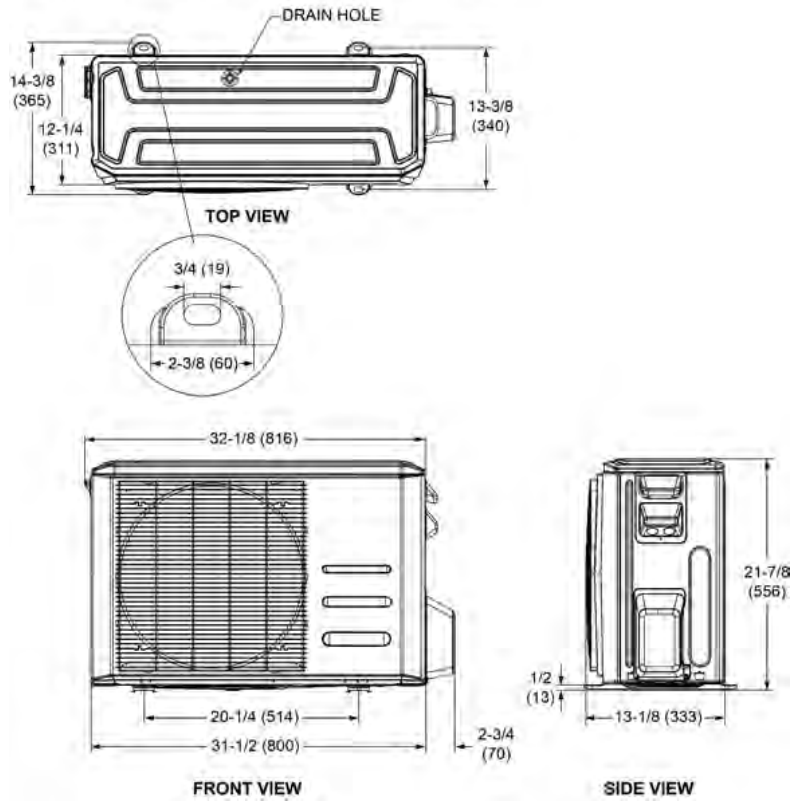

INDOOR DIMENSIONAL DRAWINGS - INCHES (MM)

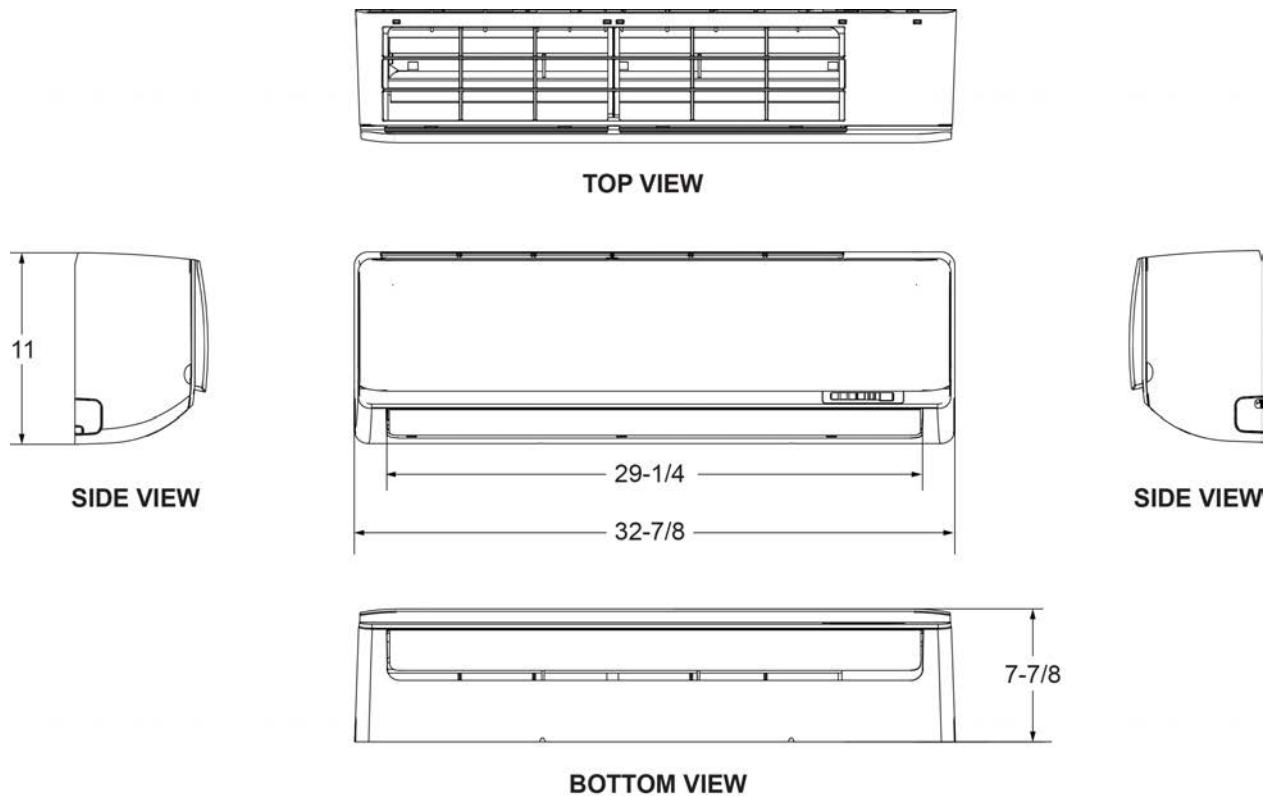

NOTE – Due to Lennox’ ongoing commitment to quality, Specifications, Ratings and Dimensions subject to change without notice and without incurring liability. Improper installation, adjustment, alteration, service or maintenance can cause property damage or personal injury. Installation and service must be performed by a qualified installer and servicing agency.