



SUBMITTAL DATA – CEILING CASSETTE
MPB012S4S-1P – M22A012S4-2P
 SINGLE ZONE MINI-SPLIT HEAT PUMP

Job: _____
Location: _____
Schedule No.: _____
System Designation: _____

Engineer: _____
Architect: _____
Date: _____
For: Reference Approval Review Construction

FEATURES

MPB012S4S-1P

- DC Inverter Control
- Base Pan Heater
- Low Ambient Cooling/Heating
- Defrost Control
- Crankcase Heater

M22A012S4-2P

- Pre Heat Function
- Built-In Condensate Pump
- Flare Connections
- R-410A Refrigerant
- Auto Restart
- Four selectable fan speeds
- LED Display
- Wireless Remote Included

OUTDOOR SPECIFICATIONS

PERFORMANCE

Cooling Capacity (Btu/h) ¹	12,000
EER	14
SEER	21.5
Heating Capacity (Btu/h) ¹	12,000
HSPF	10.5
Outdoor Fan Total Air Volume (CFM)	1200
Ambient Temperature Operating Range	
Cooling	-13 - 122°F
Heating	-13 - 86°F

ELECTRICAL DATA

Power Supply (V/Hz/Φ)	208-230/60/1
Minimum Circuit Ampacity (A)	12
Maximum Overcurrent Protection (A)	15
Outdoor Fan Motor RLA (A)	0.4
Compressor RLA (A)	6.8
No. of Compressors	1

GENERAL DATA

Connection Ratio (%)	100%
Max. # of Indoor Units	1 unit
Sound Data (dBA) - Cooling/Heating	55 / 55
Refrigerant type	R-410A
Factory refrigerant charge	2 lbs. 9 oz.

DIMENSIONS

Unit Dimensions (in)	Height	21-7/8
	Width	31-1/2
	Depth	13-3/8
Shipping Weight (lb)		83
Net Weight (lb)		77

PRODUCT WARRANTY

Compressor – Twelve year limited warranty.
 All other covered components – Twelve year limited warranty.
 Product registration required.

OPTIONAL ACCESSORIES

Non-Programmable Controller (M0STAT61Q-1)	
Wireless Remote Controller (M0STAT60Q-1)	1+
Programmable Controller (M0STAT64Q-1)	

INDOOR SPECIFICATIONS

PERFORMANCE

Airflow (CFM)	High	380
	Medium	310
	Low	260
External Static Pressure (in. w.g.)		-
Sound Pressure (dBA)	High	43
	Medium	39
	Low	36

ELECTRICAL DATA

Power Supply (V/Hz/Φ)	Supplied by ODU
Rated load amps (RLA)	1.0
Power Output (W)	46

DIMENSIONS

Unit Dimensions (in)	Height	10-3/8
	Width	22-1/2
	Depth	22-1/2
Liquid Pipe Connection (in)		1/4
Gas Pipe Connection (in)		1/2
Condensate drain connection (in)		1
Unit Shipping Weight (lb)		41
Unit Net Weight (lb)		36

NOTES

- Cooling and Heating Capacity data is rated at the following conditions:
 Cooling: 80°FDB / 67°FWB Indoor, 95°FWB / 75°FDB Outdoor
 Heating: 70°FDB / 60°FWB Indoor, 47°FDB / 43°FWB Outdoor
- Cassette Panel (M0STAT62Q-1) ordered separately.



NOTE – Due to Lennox' ongoing commitment to quality, Specifications, Ratings, and Dimensions are subject to change without notice and without incurring liability. Improper installation, adjustment, alteration, service or maintenance can cause property damage or personal injury. Installation and service must be performed by a qualified installer and servicing agency.



SUBMITTAL DATA - CEILING CASSETTE
MPB012S4S-1P - M22A012S4-2P
SINGLE ZONE MINI-SPLIT HEAT PUMP

OUTDOOR DIMENSIONAL DRAWINGS - INCHES (MM)

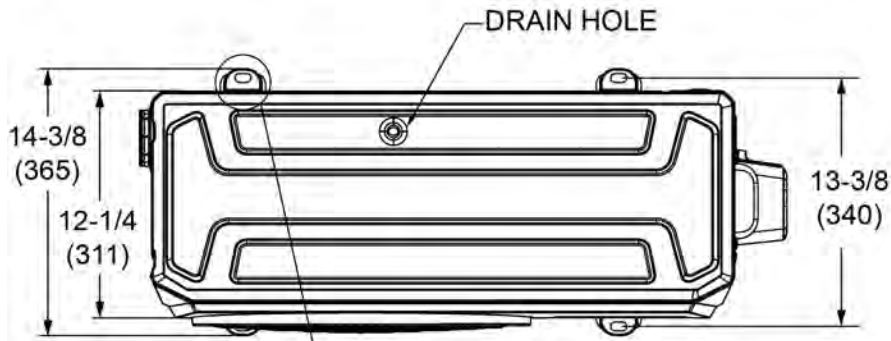

TOP VIEW

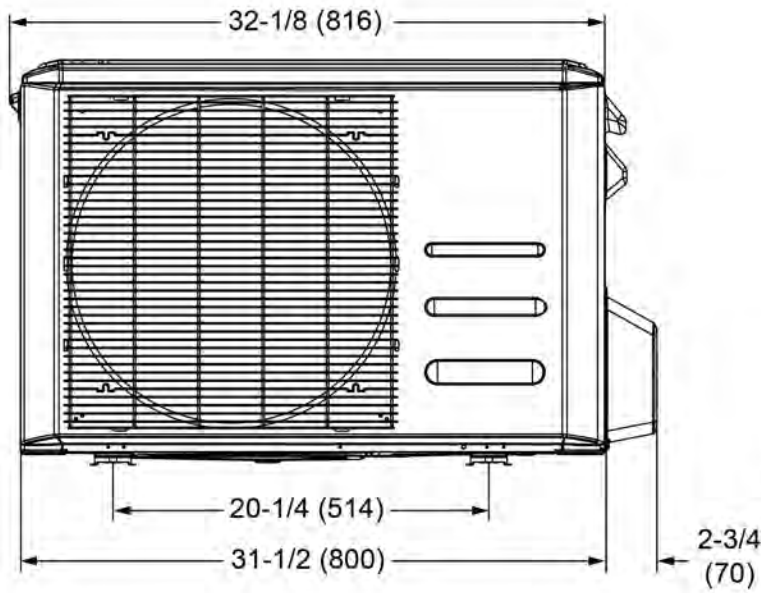
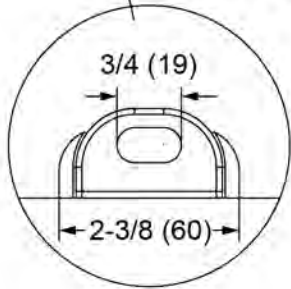

FRONT VIEW

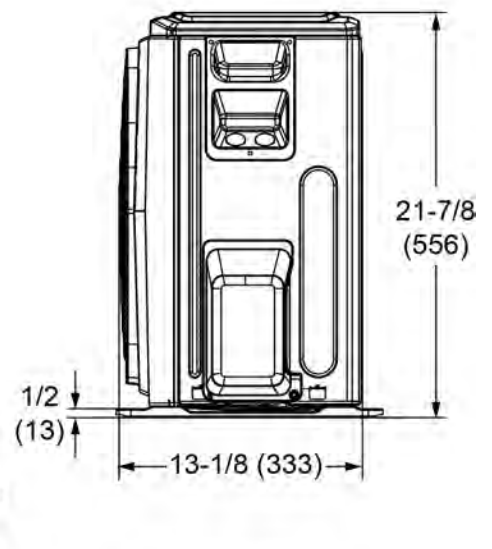

SIDE VIEW

NOTE - Due to Lennox' ongoing commitment to quality, Specifications, Ratings, and Dimensions are subject to change without notice and without incurring liability. Improper installation, adjustment, alteration, service or maintenance can cause property damage or personal injury. Installation and service must be performed by a qualified installer and servicing agency.



SUBMITTAL DATA - CEILING CASSETTE

MPB012S4S-1P - M22A012S4-2P

SINGLE ZONE MINI-SPLIT HEAT PUMP

INDOOR DIMENSIONAL DRAWINGS - INCHES (MM)

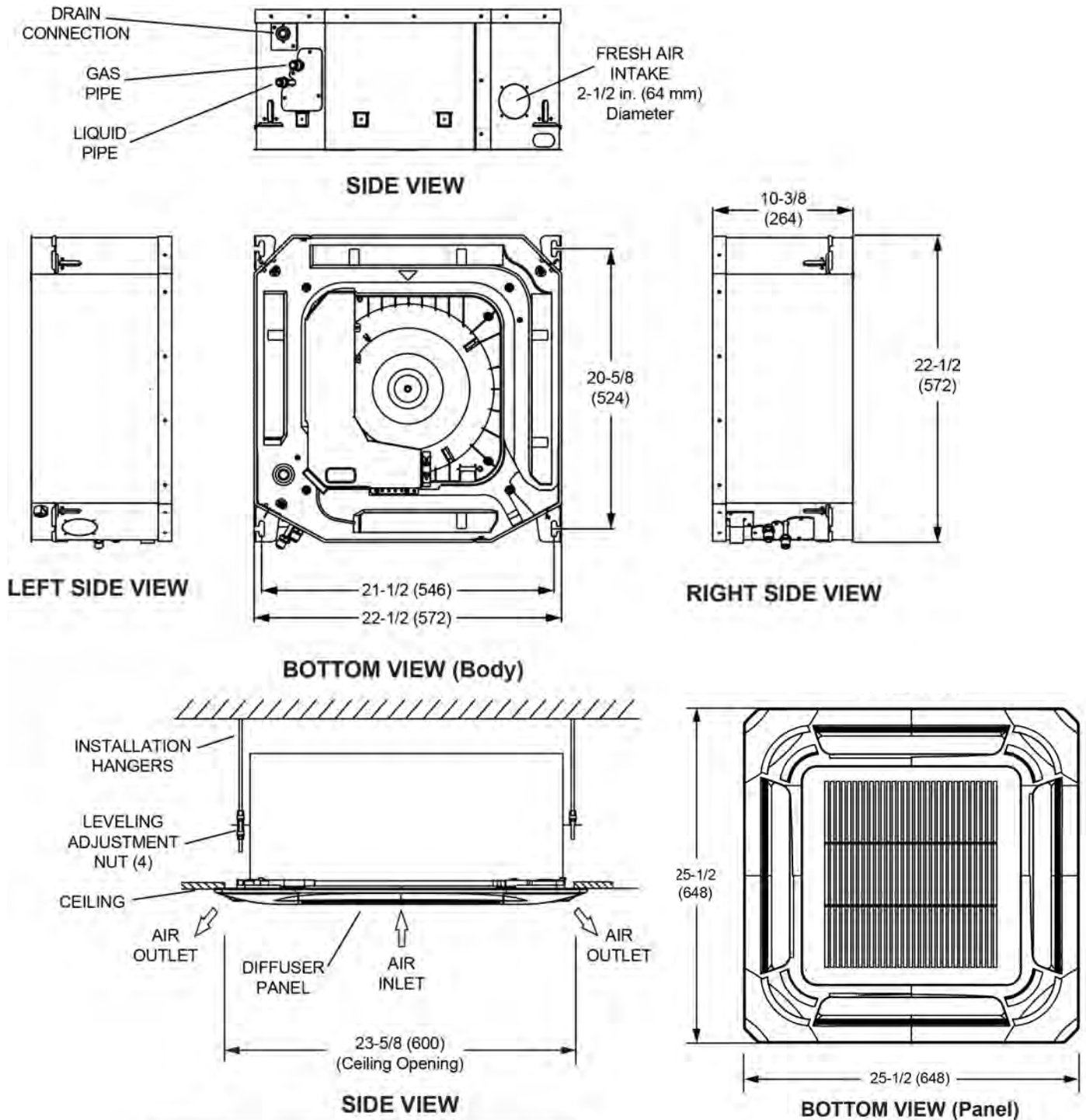

NOTE - Due to Lennox' ongoing commitment to quality, Specifications, Ratings, and Dimensions are subject to change without notice and without incurring liability. Improper installation, adjustment, alteration, service or maintenance can cause property damage or personal injury. Installation and service must be performed by a qualified installer and servicing agency.