



SUBMITTAL DATA - INDOOR UNIT

VMDA009H4-2P

VRF HEAT PUMP & HEAT RECOVERY

Job: _____

Location: _____

Schedule No.: _____

System Designation: _____

Engineer: _____

Architect: _____

Date: _____

For: Reference Approval Review Construction

Medium Static Ducted Indoor Unit

FEATURES

- Pre Heat Function
- Auto Addressing
- Auto Restart
- Integral Condensate Pump
- Electronic Expansion Valve
- ECM Motor
- Flare Connections
- LED Display
- Washable Filter
- Refrigerant R-410A
- Nine capacity sizes from 7,000 to 48,000 Btu/h

SPECIFICATIONS

PERFORMANCE

Cooling Capacity ¹ (Btu/h)		9,000
Heating Capacity ¹ (Btu/h)		10,900
Airflow (CFM)	High	341
	Medium	294
	Low	247
External Static Pressure (in. WC)		0.30
Sound Pressure (dBA)	High	38.2
	Medium	36.2
	Low	34.4

ELECTRICAL DATA

Power Supply (V/Hz/Φ)	208-230/60/1
Minimum circuit ampacity (MCA)	0.65
Max. Overcurrent Protection (MOCP)	15
Cooling Power Input ² (W)	120
Cooling Rated current (A)	0.55
Heating Power Input ² (W)	120
Heating Rated current (A)	0.55
Indoor Fan Motor Input (W)	100

DIMENSIONS

Unit Dimensions (in)	Height	8-1/4
	Width	39-1/4
	Depth	19-3/4
Liquid Pipe Connection (in)		1/4
Gas Pipe Connection (in)		1/2
Condensate drain connection (in)	(1)	1-1/4
Unit Shipping Weight (lb)		58
Unit Net Weight (lb)		49



OPTIONAL ACCESSORIES

<input type="checkbox"/> Non-Programmable Controller	V0STAT54P
<input type="checkbox"/> Programmable Controller	V0STAT51P
<input type="checkbox"/> Infrared Wireless Controller	V0STAT52P-1
<input type="checkbox"/> Infrared Sensor	V0SNSR78P-1
<input type="checkbox"/> Remote Sensor	V0SNSR00P-1
<input type="checkbox"/> HHE Relay Kit	V0CTRL92P-1
<input type="checkbox"/> Hotel Keycard Interface	V0CTRL88P-1

NOTES

- Cooling and Heating capacity data is rated at the following conditions:
Cooling: 80°FDB / 67°FWB Indoor, 95°FDB Outdoor
Heating: 70°FDB Indoor, 47°FDB / 43°FWB Outdoor
- Power Input values are rated at high fan speed.



NOTE – Due to Lennox' ongoing commitment to quality, Specifications, Ratings and Dimensions subject to change without notice and without incurring liability. Improper installation, adjustment, alteration, service or maintenance can cause property damage or personal injury. Installation and service must be performed by a qualified installer and servicing agency.



SUBMITTAL DATA - INDOOR UNIT
VMDA009H4-2P
 VRF HEAT PUMP & HEAT RECOVERY

DIMENSIONAL DRAWINGS - INCHES (MM)

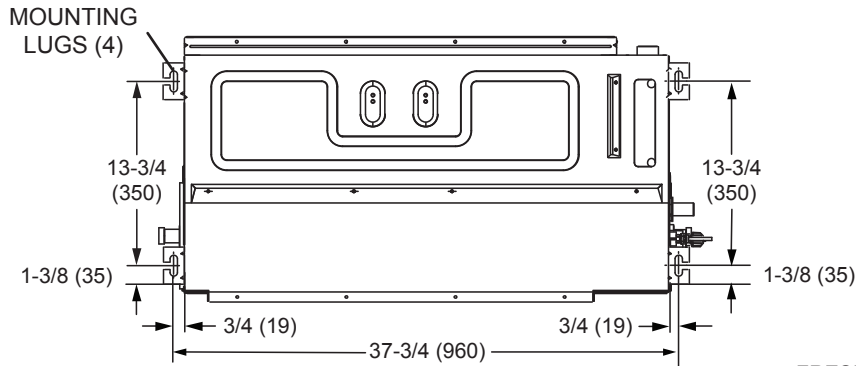

TOP VIEW

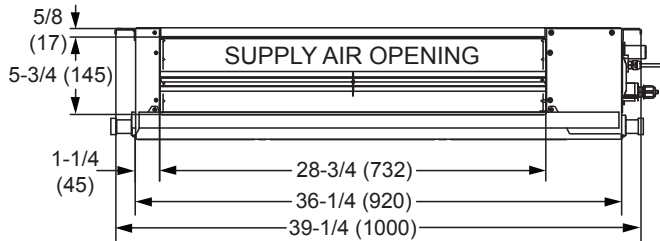

FRONT VIEW

FRESH AIR INTAKE
 3-5/8 (92) Diameter

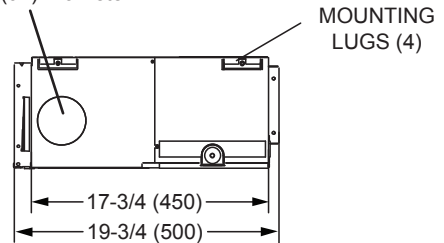

SIDE VIEW



REAR VIEW

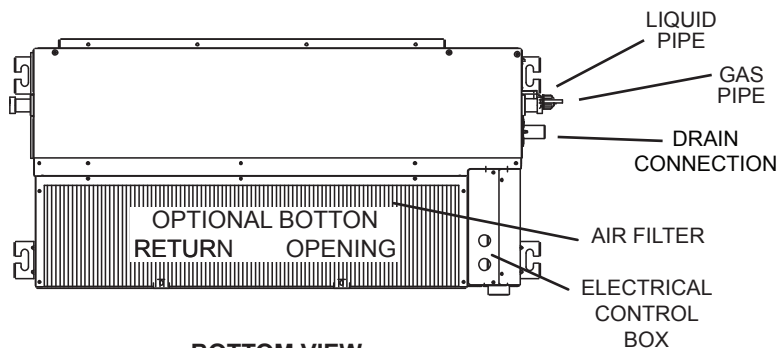

BOTTOM VIEW

NOTE - Due to Lennox' ongoing commitment to quality, Specifications, Ratings and Dimensions subject to change without notice and without incurring liability. Improper installation, adjustment, alteration, service or maintenance can cause property damage or personal injury. Installation and service must be performed by a qualified installer and servicing agency.