

INSTALLATION INSTRUCTIONS

CH23 Series Coils

HORIZONTAL EVAPORATOR COILS

503,486M (098001701)
9/2014
Supersedes 3/2013

**THIS MANUAL MUST BE LEFT WITH THE HOMEOWNER
FOR FUTURE REFERENCE**

⚠ WARNING

Improper installation, adjustment, alteration, service or maintenance can cause personal injury, loss of life, or damage to property.

Installation and service must be performed by a qualified installer or service agency.

⚠ WARNING

Risk of explosion or fire.

Can cause injury or death.

Recover all refrigerant to relieve pressure before opening the system.

⚠ CAUTION

Physical contact with metal edges and corners while applying excessive force or rapid motion can result in personal injury. Be aware of, and use caution when working near these areas during installation or while servicing this equipment.

⚠ IMPORTANT

The Clean Air Act of 1990 bans the intentional venting of refrigerant (CFCs, HCFCs and HFCs) as of July 1, 1992. Approved methods of recovery, recycling or reclaiming must be followed. Fines and/or incarceration may be levied for noncompliance.

Table of Contents

General	1
Shipping and Packing List	1
CH23 Coil Dimensions	2
Installation	3
CH23 Refrigeration Systems	3
Refrigerant Line Connections	3
Condensate Drain Connections	5
Sealing Ducts	5
Evaporator Coil Air Pressure Drop	5
Clean-Up	6
Maintenance	6

General

The CH23 series horizontal coils are designed for installation with a horizontal furnace and a matched outdoor unit. These units are for indoor installation only. Refer to the CH23 Product Specification bulletin for match-up information.

These instructions are intended as a general guide and do not supersede local or national codes in any way. Authorities having jurisdiction should be consulted before installation.

The coil drain pan is high quality engineering polymer with a maximum service temperature of 500°F. However, adequate space must be provided between the drain pan and furnace heat exchanger. At least 2" space is required for heat exchanger and 4" for drum-type or oil-fired furnace heat exchanger. Closer spacing may damage the drain pan and cause leaking.

Check contents for shipping damage. If any damage is found, contact the last carrier immediately.

Shipping and Packing List

Package 1 of 1 contains the following:

- 1- Coil cabinet assembly
- 1- Bag assembly containing the following:
 - 1-Suction line elbow with equalizer port
 - 1-90° liquid line stub
 - 1-O-ring
 - 1-Heat shield
 - 1-3/8 inch x 5/16 inch reducer coupling (-21, -31 only)
 - 1-7/8 inch x 5/8 inch reducer bushing (-21, -31 only)
 - 1-7/8 inch x 3/4 inch reducer bushing (-41 only)

Check equipment for shipping damage. If you find any damage, immediately contact the last carrier.

CH23 Coil Dimensions

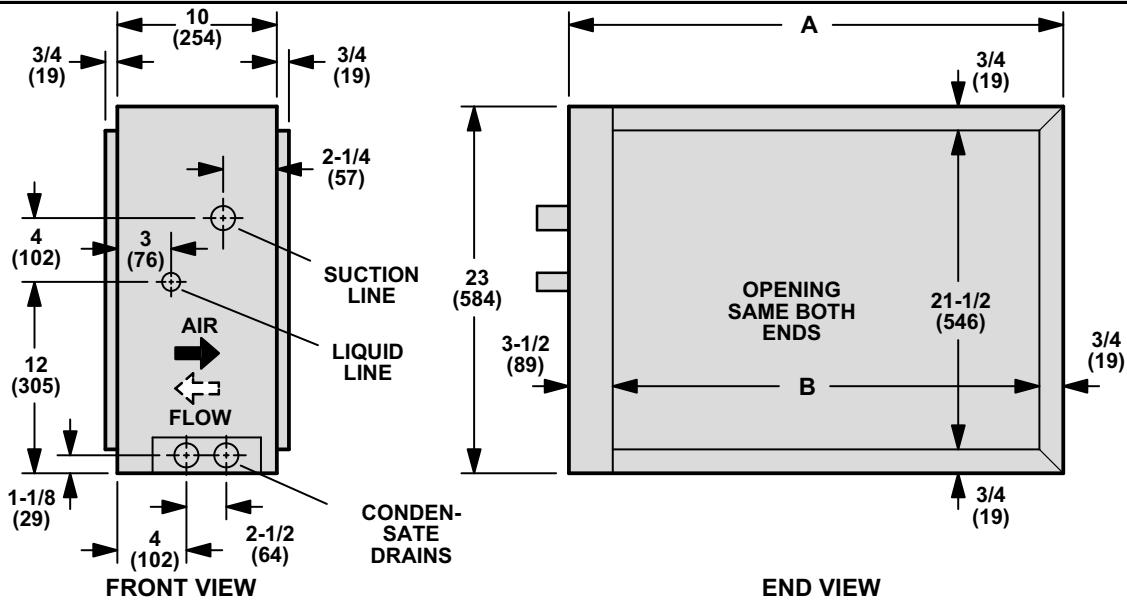

Model No.	A		B	
	in.	mm	in.	mm
CH23-21	27	686	22-3/4	578
CH23-31	31	787	26-3/4	679
CH23-41	31	787	26-3/4	679
CH23-51	35	889	30-3/4	781
CH23-65	41	1041	36-3/4	933
CH23-68	47	1194	42-3/4	1086

⚠ WARNING

This product and/or the indoor unit it is matched with may contain fiberglass wool.

Disturbing the insulation during installation, maintenance, or repair will expose you to fiberglass wool dust. Breathing this may cause lung cancer. (Fiberglass wool is known to the State of California to cause cancer.)

Fiberglass wool may also cause respiratory, skin, and eye irritation.

To reduce exposure to this substance or for further information, consult material safety data sheets available from the OEM manufacturer, or contact your supervisor.

Installation

NOTE - To remove the coil from its casing after installation, remove the two shipping screws from the coil flange. See Figure 1.

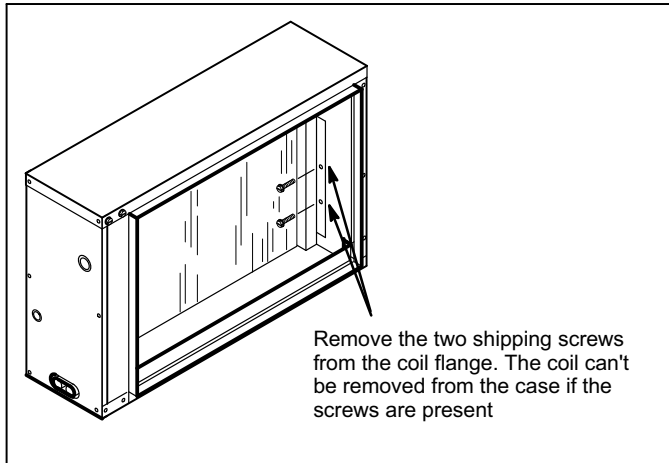

Figure 1. Removing Shipping Screws

1. CH23 cabinet must be installed for horizontal air flow.
NOTE — Coils are designed for air flow from either direction.
2. Use field-fabricated transitions or adaptors (recommended 18 inches minimum width) to connect CH23 and blower unit.
3. Connect supply and return duct work.

Refrigerant Systems

CH23 coils are factory equipped with a fitting that may incorporate either an RFCIV (fixed orifice) or TXV expansion valve metering device.

A **90° liquid line stub** and an **o-ring** (provided in the bag assembly) are used with the seal nut to accommodate installation of either type of refrigerant metering devices.

Also shipped with the coil is a **90° suction line elbow** with a 1/4 inch port to facilitate the use of an expansion valve. The size of the suction line elbow allows the suction line piping to be routed as desired and allows room to install the TXV bulb close to the port before insulating.

- For **RFC** applications, use the fixed orifice shipped with the air conditioner unit to ensure proper match-up.
- For **TXV** applications, refer to the outdoor unit engineering handbook (heat pump or air conditioning unit) data for appropriate TXV expansion valve part number.

Refrigerant Line Connections

Liquid line connections on CH23 units are 3/8 inch sweat connections. Suction line connections on CH23 units are 7/8 inch sweat connections. Apply line sets and refrigerant control devices to correspond with matching remote condensing unit.

NOTE — CH23 evaporators use nitrogen or dry air as a holding charge. If there is no pressure when you remove the rubber plugs (Step A), check the coil or line set for leaks before installing. After installation, pull a vacuum on the line set and coil before releasing the outdoor unit charge into the system.

CONNECTING SUCTION LINE

1. Place heat shield against the piping plate and around the suction line connection. Heat shield must be in place to guard against damage to the paint.
2. With heat shield in place, sweat in suction line. Suction line elbow service port has no core. Secure cap to port to prevent leakage. After procedure is completed, remove heat shield.
3. Refer to instructions provided with outdoor unit for leak testing, evacuating and charging procedures.

FIXED ORIFICE APPLICATIONS (LIQUID LINE)

Use Figure 2 to either remove or installation a fixed orifice metering device.

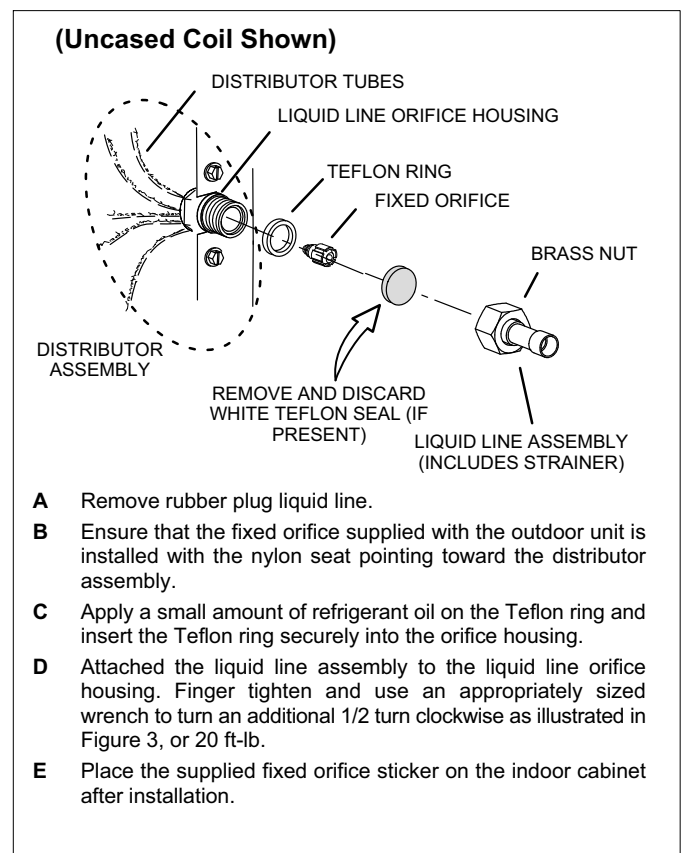

Figure 2. Typical Fixed Orifice Metering Device Installation Procedure

TXV APPLICATIONS (LIQUID LINE)

Use Figure 2 to either remove or installation a fixed orifice metering device.



THIS OUTDOOR UNIT IS DESIGNED FOR USE IN SYSTEMS THAT USE A CHECK EXPANSION VALVE METERING DEVICE. SEE THE *OUTDOOR UNIT PRODUCT SPECIFICATION* FOR APPROVED EXPANSION VALVE KIT MATCH-UPS AND APPLICATION INFORMATION.

THE EXPANSION VALVE UNIT CAN BE INSTALLED INTERNAL OR EXTERNAL TO THE INDOOR COIL. IN APPLICATIONS WHERE AN UNCASSED COIL IS BEING INSTALLED IN A FIELD-PROVIDED PLENUM, INSTALL THE CHECK EXPANSION VALVE IN A MANNER WHICH PROVIDES ACCESS FOR FIELD SERVICING OF THE EXPANSION VALVE. REFER TO BELOW ILLUSTRATION FOR REFERENCE DURING INSTALLATION OF EXPANSION VALVE UNIT.

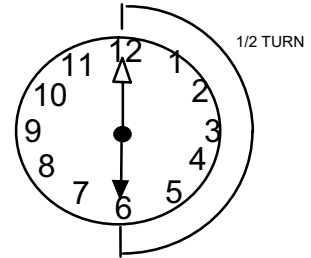
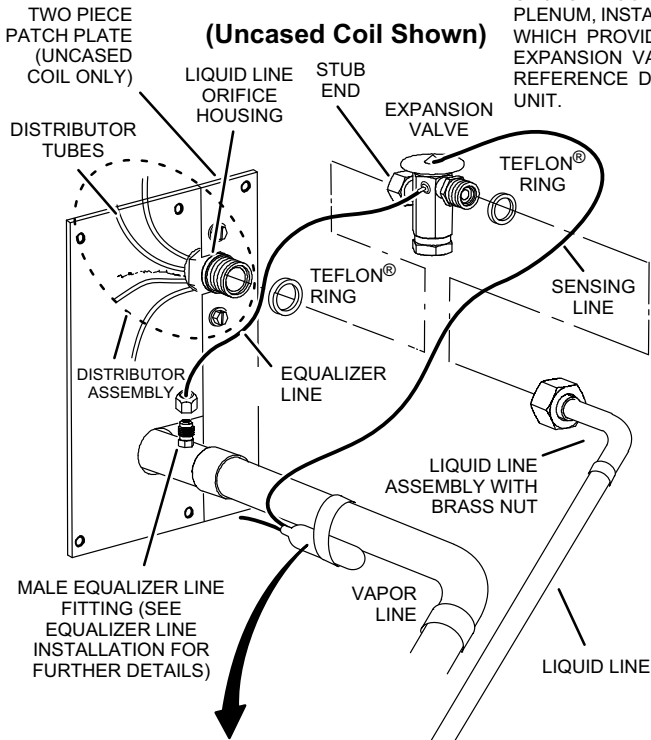

- A REMOVE THE FIELD-PROVIDED FITTING THAT TEMPORARILY RECONNECTED THE LIQUID LINE TO THE INDOOR UNIT'S DISTRIBUTOR ASSEMBLY.
- B INSTALL ONE OF THE PROVIDED TEFLON® RINGS AROUND THE STUBBED END OF THE EXPANSION VALVE AND LIGHTLY LUBRICATE THE CONNECTOR THREADS AND EXPOSE SURFACE OF THE TEFLON® RING WITH REFRIGERANT OIL.
- C ATTACH THE STUBBED END OF THE EXPANSION VALVE TO THE LIQUID LINE ORIFICE HOUSING. FINGER TIGHTEN AND USE AN APPROPRIATELY SIZED WRENCH TO TURN AN ADDITIONAL 1/2 TURN CLOCKWISE AS ILLUSTRATED IN THE FIGURE ABOVE, OR 20 FT-LB.
- D PLACE THE REMAINING TEFLON® WASHER AROUND THE OTHER END OF THE EXPANSION VALVE. LIGHTLY LUBRICATE CONNECTOR THREADS AND EXPOSE SURFACE OF THE TEFLON® RING WITH REFRIGERANT OIL.
- E ATTACH THE LIQUID LINE ASSEMBLY TO THE EXPANSION VALVE. FINGER TIGHTEN AND USE AN APPROPRIATELY SIZED WRENCH TO TURN AN ADDITIONAL 1/2 TURN CLOCKWISE AS ILLUSTRATED IN THE FIGURE ABOVE OR 20 FT-LB.

SENSING BULB INSULATION IS REQUIRED IF MOUNTED EXTERNAL TO THE COIL CASING. SEE SENSING BULB INSTALLATION FOR BULB POSITIONING.

SENSING BULB INSTALLATION

- A ATTACH THE VAPOR LINE SENSING BULB IN THE PROPER ORIENTATION AS ILLUSTRATED TO THE RIGHT USING THE CLAMP AND SCREWS PROVIDED.

NOTE - CONFIRM PROPER THERMAL CONTACT BETWEEN VAPOR LINE AND CHECK EXPANSION BULB BEFORE INSULATING THE SENSING BULB ONCE INSTALLED.

- B CONNECT THE EQUALIZER LINE FROM THE EXPANSION VALVE TO THE EQUALIZER VAPOR PORT ON THE VAPOR LINE. FINGER TIGHTEN THE FLARE NUT PLUS 1/8 TURN (7 FT-LBS) AS ILLUSTRATED BELOW.

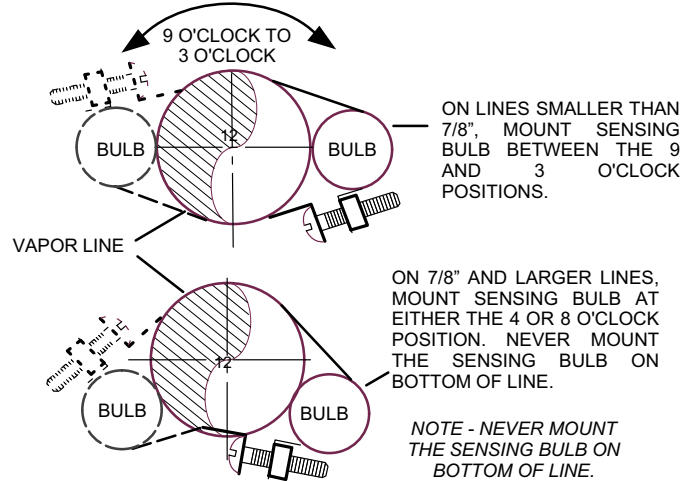
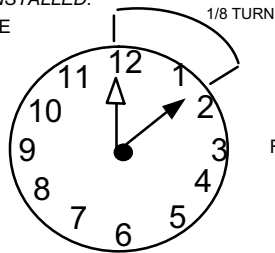

EQUALIZER LINE INSTALLATION

REMOVE AND DISCARD EITHER THE FLARE SEAL CAP OR FLARE NUT WITH COPPER FLARE SEAL BONNET FROM THE EQUALIZER LINE PORT ON THE VAPOR LINE AS ILLUSTRATED IN THE FIGURE TO THE RIGHT.

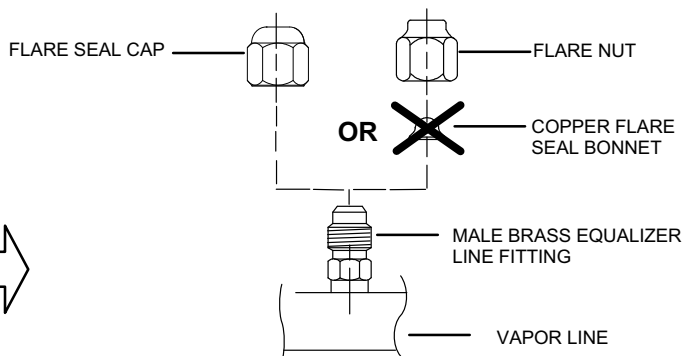

Figure 3. Typical TXV Metering Device Removal and Installation Procedure

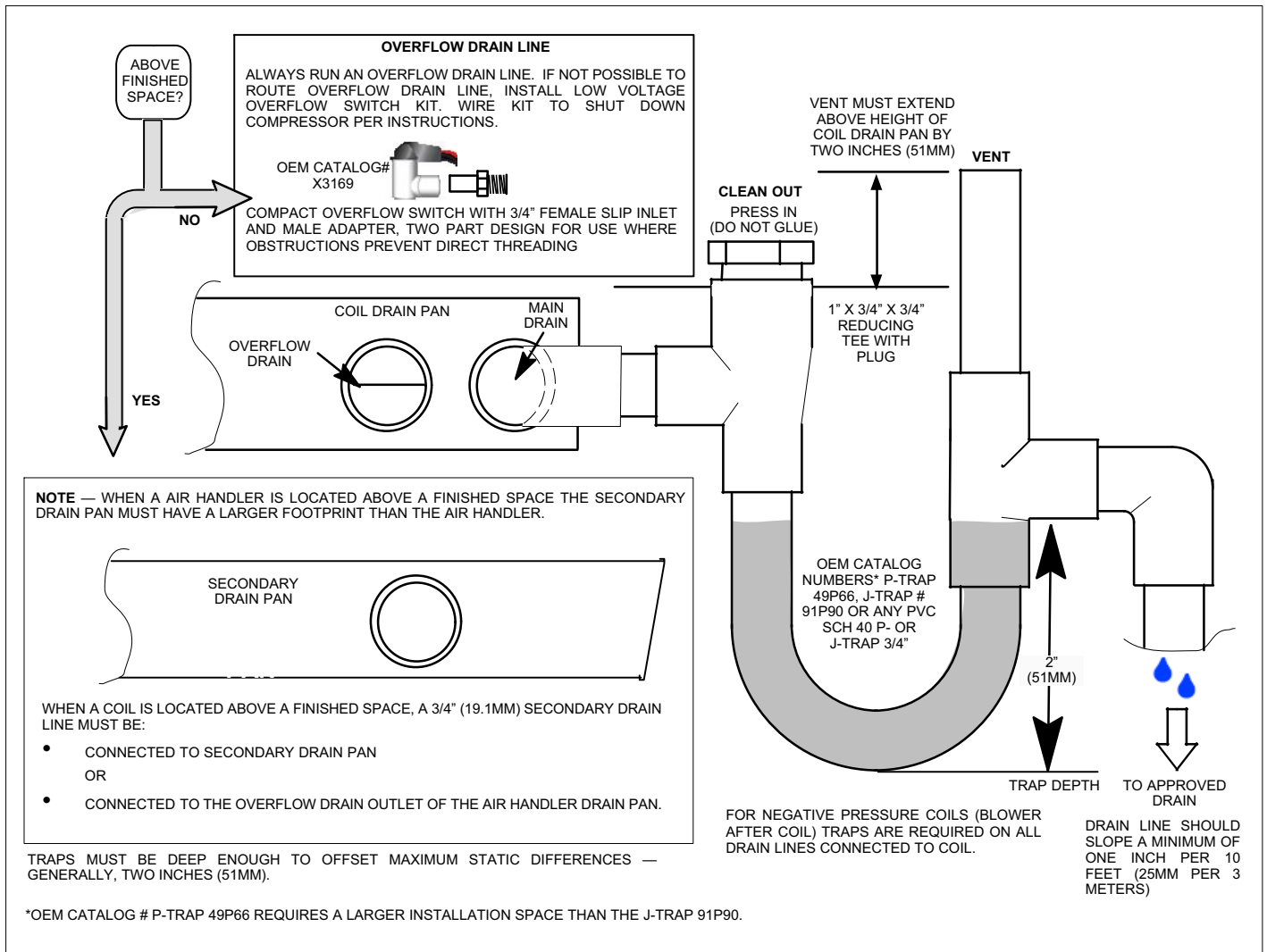

Figure 4. Typical Main and Overflow Drain Installations

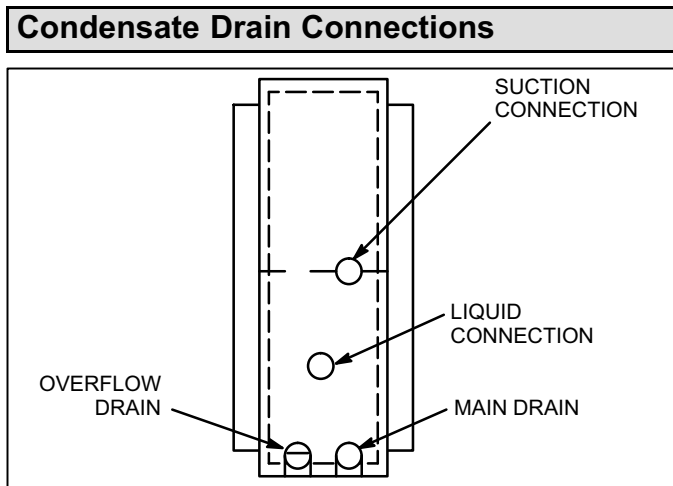

Figure 5. Connections

CH23 coil has both main and overflow drains. Overflow drain removes condensation should main drain become

plugged. Refer to Figure 5 for auxiliary and main drain locations.

MAIN DRAIN

Connect the main drain and route downward to drain line or sump. Do not connect drain to a closed waste system. See Figure 4 for typical drain trap configuration.

OVERFLOW DRAIN

It is recommended that the overflow drain is connected to a overflow drain line for all units. If overflow drain is not connected, it must be plugged with provided cap.

BEST PRACTICES

The following best practices are recommended to ensure better condensate removal:

- Main and overflow drain lines should **NOT** be smaller than both drain connections at drain pan.
- Overflow drain line should run to an area where homeowner will notice drainage.
- It is recommended that the overflow drain line be vented and a trap installed. Refer to local codes.

Sealing Ducts

⚠ WARNING

There must be an airtight seal between the bottom of the furnace and the return air plenum. Use fiberglass sealing strips, caulking, or equivalent sealing method between the plenum and the air handler cabinet to ensure a tight seal. Return air must not be drawn from a room where this air handler or any gas-fueled appliance (i.e., water heater), or carbon monoxide-producing device (i.e., wood fireplace) is installed.

Ensure the duct is secured and all joints are properly sealed to either the coil cabinet flanges (fully cased models) or the furnace cabinet flanges (uncased models).

Evaporator Coil Air Pressure Drop

1. Drill test holes in supply duct to read pressure drop across CH23 coil. See Figure 6.

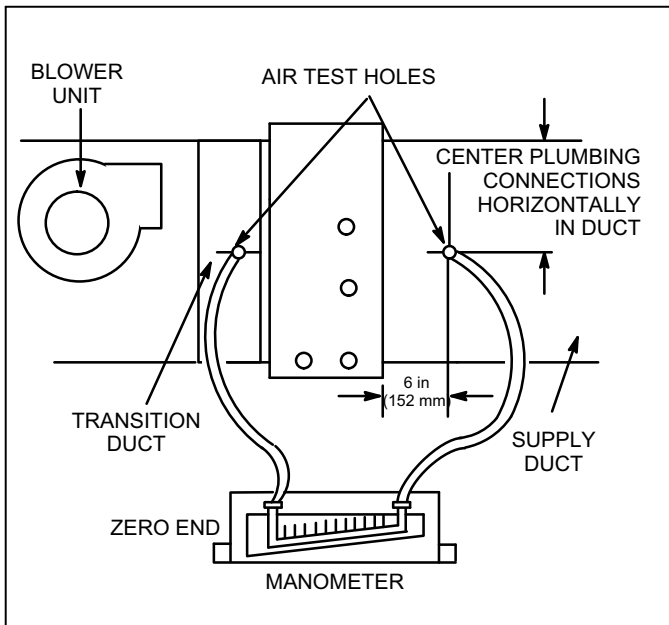

Figure 6. Air Test Hole Locations

2. Connect draft gauge with zero end of scale at air entering side of coil. Insert 1/4 inch (6 mm) of test holes inside cabinet. Seal around test hose with permagum.
3. Table 1 lists a range of air volumes and equivalent draft gauge readings, as well as maximum operating CFM. Observe draft gauge readings with blower access panel in place and blower operating. If reading is low, close adjustable pulley or wire direct drive blower to higher speed. If reading is high, open adjustable pulley or wire to a lower blower speed. Close blower access panel each time to eliminate false readings.

Clean-Up

1. Insulate refrigerant connections at CH23 coil system suction line. Use a wrap-around insulation.
2. Set room thermostat at desired setting.
3. Pick up all shipping cartons, metal scraps, extra insulation and clean up the installation area.

**Table 1. Draft Gauge Reading (Dry Evaporator)
400 CFM/190 L/S Per Ton**

Model No.	Air Volume		Total Resistance	
	cfm	L/s	in. w.g.	Pa
CH23-21	600	285	.05	12
	800	380	.07	17
CH23-31	1000	470	.04	10
CH23-41	1200	565	.09	22
CH23-51	1600	755	.17	42
CH23-65 CH23-68	1800	850	.20	50
	2000	945	.24	60
	2200	1040	.28	70
	2400	1135	.32	80

Maintenance

⚠ CAUTION

A damaged coil fin can affect equipment operation and performance. Do not use flame, high-pressure water, steam, or volatile cleaners on fins or tubing surfaces. If cleaning requires the use of acidic or alkaline cleaners, follow the manufacturer's instructions. Thoroughly flush cleaner from all equipment components. (Be careful to prevent damage or corrosion of the components connected to the system or areas surrounding the equipment being cleaned.)

A trained technician or service agency must perform maintenance and service on equipment. At the beginning of each ing or cooling season, indoor coils should be cleaned.

Do not use hydrofluoric acid, alkaline, or similar chemicals on coils. These chemicals are not necessary to dissolve salt, and may damage the fin coating. Acid washes are used to dissolve oils and greases, which generally are not present on most installations.

Alkaline washes are useful for dissolving oxides such as zinc oxide, aluminum oxide, and iron oxide (rust). These three oxides are more corrosion-resistant than base metals, so dissolving or removing them will cause an increase in corrosion.

CLEANING THE COIL:

1. Remove the coil from the cabinet or plenum, and take the coil to an appropriate place to clean it.
2. Vacuum or brush the coil to remove matted and surface debris from the fin. Use vacuum attachments and /or brushes that are non-destructive to fins.
3. If oil deposits are present, spray the coil with ordinary household liquid detergent. Allow detergent to soften deposits and wait 10 minutes.

NOTE - For units in coastal regions, fresh water will dissolve away any salt deposits. (Wash coils with fresh water at least every six months.)

4. Spray the coil at a vertical angle of 30 to 45 degrees with a constant stream of water at moderate pressure. A pressure washer with a fan nozzle will work best. Do not spray the coil from a horizontal direction.
5. Direct the spray so that any debris is washed out of the coil and basepan. For most residential units, hot water is not necessary.

NOTE - Attempting to back flush from the inside of the coil will require removing parts from the unit, and it may be very difficult to flush the whole coil surface. Attempting to blow water through a coil will slow the water stream and reduce the flushing action of the outer fin surface.

6. Replace the coil into the cabinet or plenum. Ensure that you have followed the proper procedure for routing and securing the refrigerant tubing.

Do not use hydrofluoric acid, alkaline, or similar chemicals on coils. These chemicals are not necessary to dissolve salt, and may damage the fin coating. Acid washes are used to dissolve oils and greases, which generally are not present on most installations.

Alkaline washes are useful for dissolving oxides such as zinc oxide, aluminum oxide, and iron oxide (rust). These three oxides are more corrosion-resistant than base metals, so dissolving or removing them will cause an increase in corrosion.

