



©2015 Lennox Industries Inc.  
Dallas, Texas, USA

## CONTROLS

505.216M  
5/2015  
Supersedes 7/2014

TP Technical  
Publications  
Litho U.S.A.

# COMFORT SENSOR - ZONING KIT

## INSTALLATION INSTRUCTIONS FOR COMFORT SENSOR - ZONING (CZ) USED WITH L CONNECTION® NETWORK

### Shipping and Packing List

#### Package 1 of 1 contains:

- 1- Comfort Sensor-Zoning (CSZ)
- 3- #6 - 18 X 1" Screws
- 3- Plastic anchors
- 2- Wiring diagrams

Check panel for shipping damage. Receiving party should contact last carrier immediately if shipping damage is found.

These instructions are intended as a general guide and do not supersede local codes in any way. Authorities having jurisdiction should be consulted before installation.

### Cable Requirements

#### THERMOSTAT WIRE

Standard thermostat wire (one pair 20 AWG minimum) may be used to wire the zone controller to the optional wall plug 24VAC transformer 18M13 or other field-provided 2VA minimum, 24VAC output transformer.

#### COMMUNICATION WIRE

Use one of the following Lennox purple communication cables (twisted pair with shield plenum rated) depending on the application:

23W99	500 Ft. roll
24W00	1000 Ft. roll
24W01	2500 Ft. roll

### Application

The Comfort Sensor-Zoning (CSZ) is used with the L Connection Network in zoning applications. The CSZ transmits the zone temperature to the L Connection network and controls the zone dampers or terminal boxes. In addition to reading temperature, sensors are available with the options shown in table 1.

## ⚠ WARNING

**Improper installation, adjustment, alteration, service or maintenance can cause property damage, personal injury or loss of life. Installation and service must be performed by a qualified installer or service agency.**

TABLE 1

Options	Cat. No.	Part No.
Temperature, RH, CO <sub>2</sub> *	18W55	100939-01
Temperature RH *	18W56	100939-02
Temperature, CO <sub>2</sub> *	18W57	100939-03
Temperature *	18W58	100939-04
Temperature	18W59	100939-05
Temperature, RH	18W60	100939-06
Temperature, CO <sub>2</sub>	18W61	100939-07
Temperature, RH, CO <sub>2</sub>	18W62	100939-08

\*Control has LCD display and adjustment buttons.

### Installation

## ⚠ IMPORTANT

***Integrated board is extremely sensitive to static electricity. Care must be taken in handling. Hold subbase by the edges and avoid touching any components.***

Locate sensor in conditioned zone approximately 5 feet (1-1/2m.) above the floor in an area with good air circulation at average temperature. Avoid locating the sensor where it might be affected by:

- drafts or dead spots behind doors and in corners
- hot or cold air from ducts
- radiant heat from sun or appliances
- concealed pipes and chimneys

Install sensor on a standard handy box or directly on wall as follows:

- 1.. Cut a small hole for wires in the wall approximately 5 ft. above the floor in the appropriate zone.
- 2.. Press the tab at the bottom of the sensor to remove the cover from the baseplate.
- 3.. Center the opening in the baseplate over the opening in the wall. Mark and drill three holes for screws. See figure 1.
- 4.. Insert wall anchors in holes and secure baseplate to the wall with provided screws.
- 5.. Route twisted pair cable from the ZoneBus to the hole. Route thermostat wire from optional zone damper actuator, fan powered zone box, external sensors, etc., to the hole.
- 6.. Pull all cables through the opening in the baseplate. Connect cables as shown in figure 3 for zones using



a damper actuator. Connect cables as shown in figure 4 for zones using a zone terminal box.

- 7.. Caulk hole around cable to protect sensor from drafts.
- 8.. Affix appropriate wiring diagram(s) on inside of unit panel near other diagrams.

## External Sensors

Wire external sensors as shown in figure 2. Up to four sensors may be used in averaging sensor applications. Use Lennox part numbers 94L61 or 56L80. Sensors are not polarity sensitive.

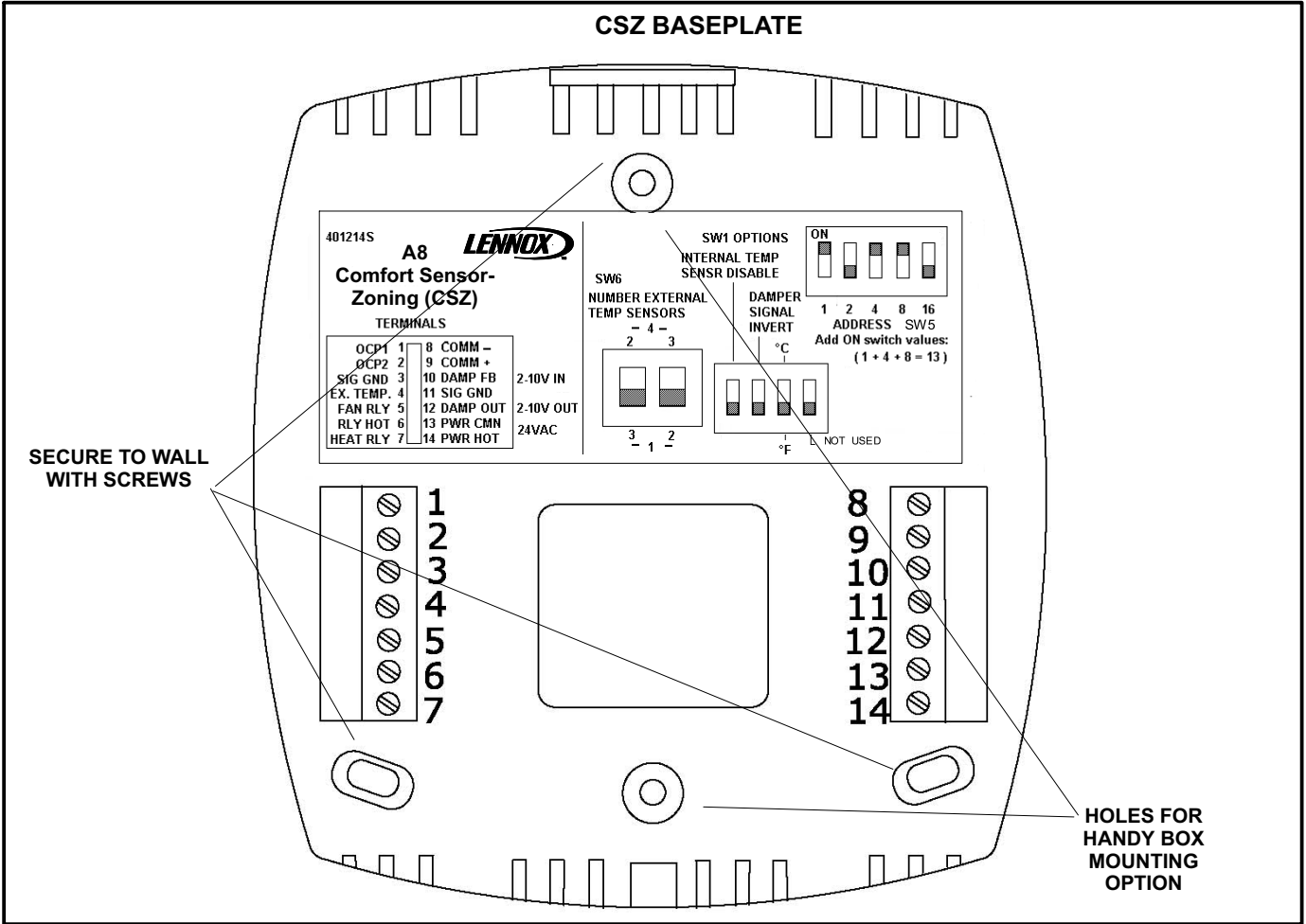

**FIGURE 1**

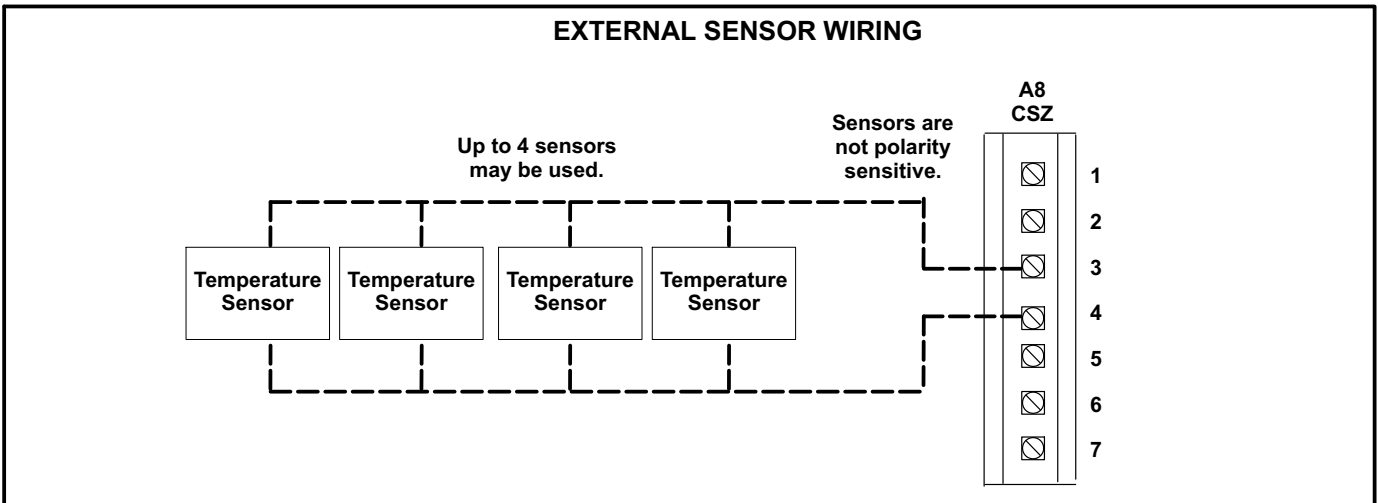

**FIGURE 2**

# COMFORT SENSOR-ZONING WIRING FOR BASIC ZONE DAMPER CONTROL

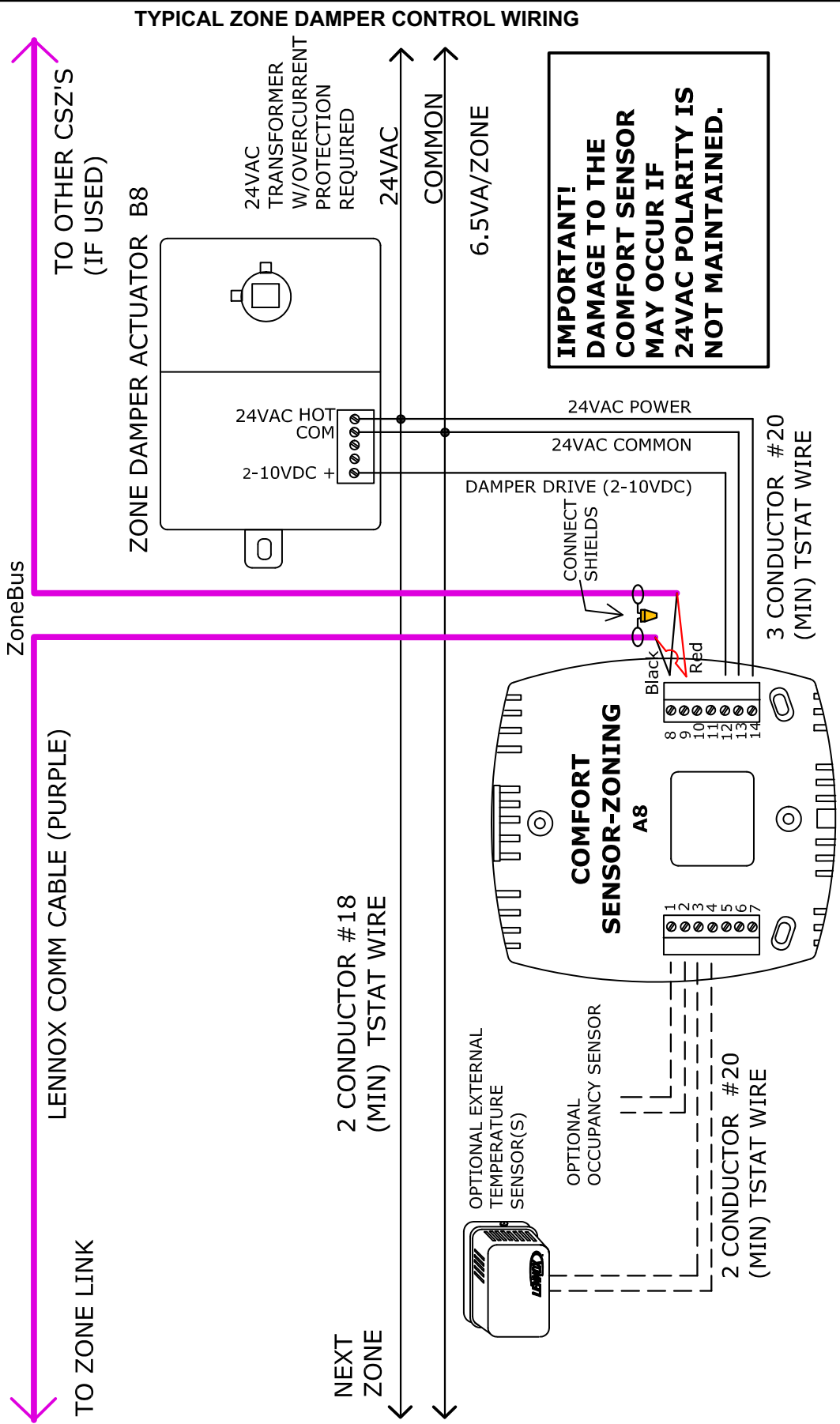

FIGURE 3

# COMFORT SENSOR-ZONING WIRING FOR TYPICAL FAN POWERED ZONE TERMINAL BOX W/HEAT

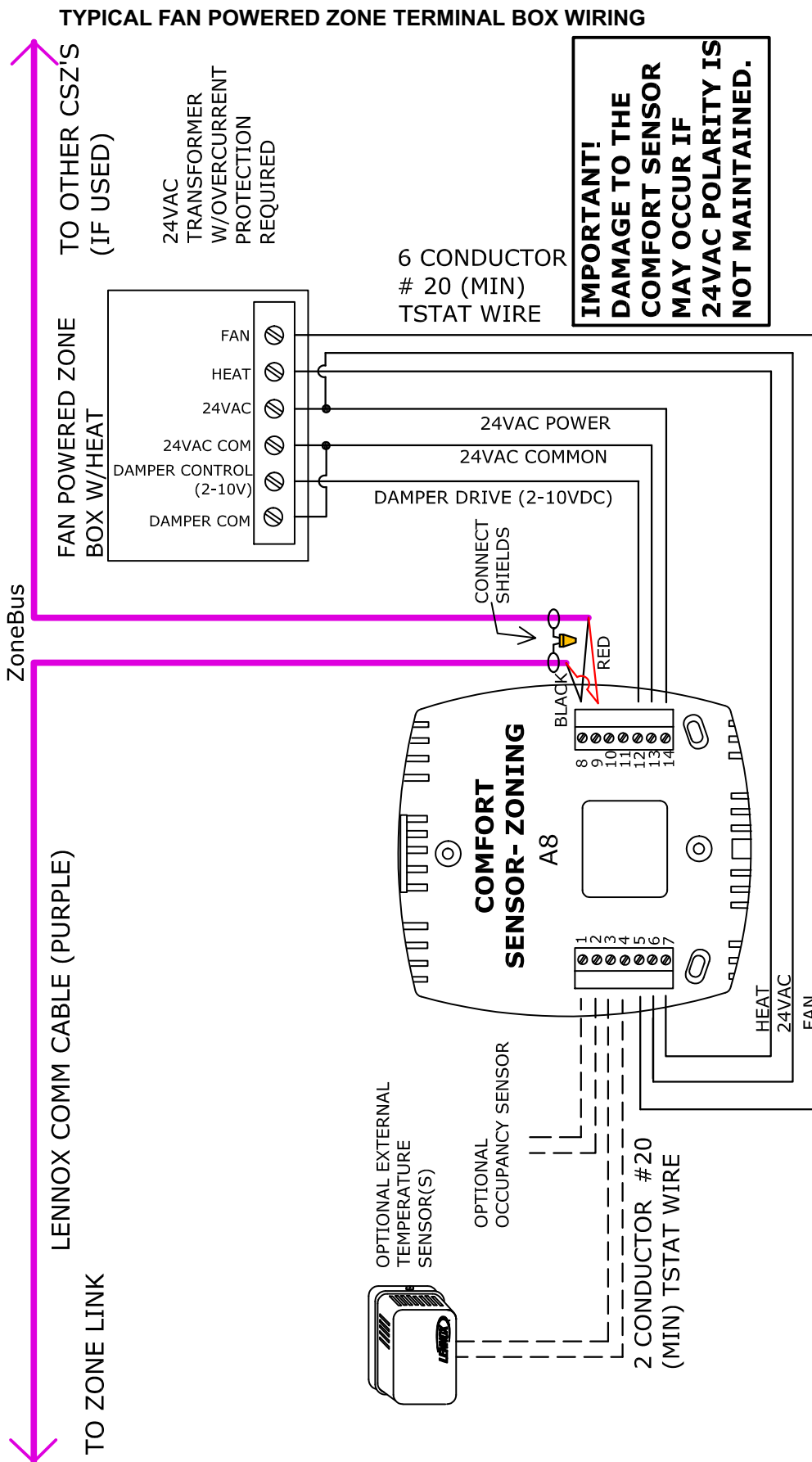

FIGURE 4

## DIP Switch Settings

See figure 5 for location of DIP switches on inside of cover. Adjust the SW5 address switches as shown in figure 6. Adjust SW1 and SW6 option switches as shown in figure 7 and 8 when option applies.

SW5 Device Address	Figure 6
SW1 Option	Figure 7
SW6 External Sensor	Figure 8

## Occupancy Sensor Input

Wire an optional, isolated, 24VAC input to CSZ terminals 1 & 2. See figures 3 and 4.

## Zone Terminal Box Outputs

Wire optional heat and fan relay outputs as shown in figure 4.

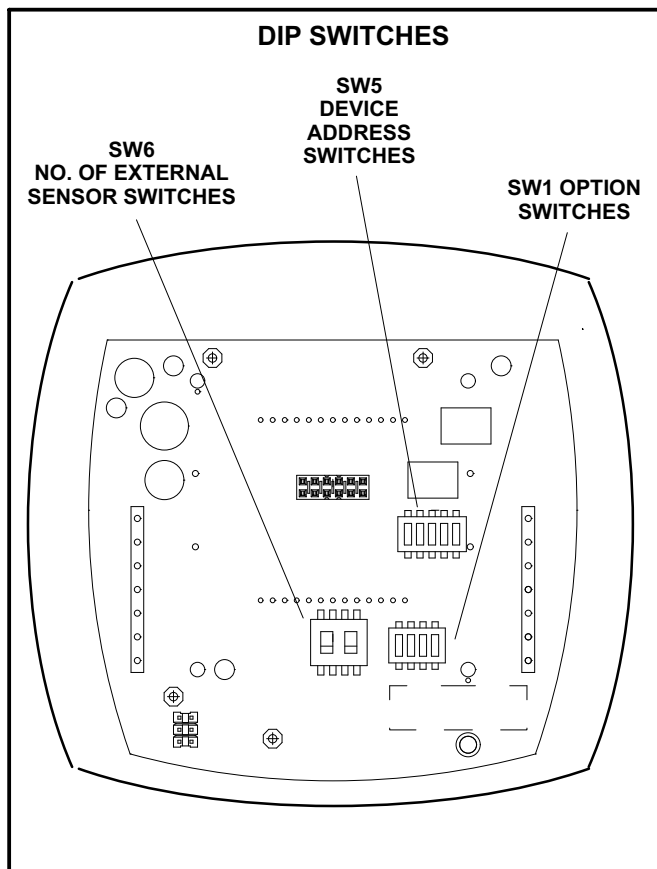
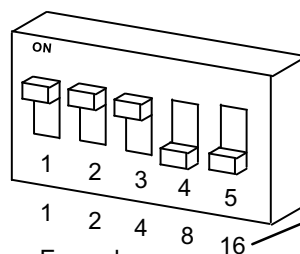

FIGURE 5

## SW5 DEVICE ADDRESS SWITCHES

Add the value of each switch moved to the on position to determine address.



Add the switch value, shown on board, NOT the number printed on the switch.

Example:  
 $1 + 2 + 4 + 0 + 0 = \text{Address } 7$

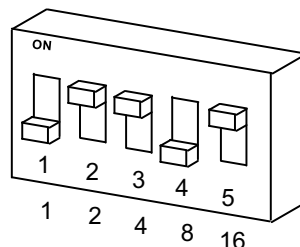

Set each CSZ to a different address between 1 and 31.

Example:  
 $0 + 2 + 4 + 0 + 16 = \text{Address } 22$

FIGURE 6

## CONTROL SW1 OPTION SWITCHES

Disables the CSZ internal temperature sensor and uses only the external sensor readings.  
 On=Disables internal temp. sensor.  
 Off=Enables CSZ internal sensor (factory default)

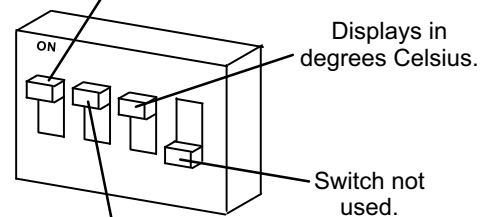

Inverts the damper output signal from the CSZ. Also inverts the optional incoming damper position feedback signal.  
 Off=Closed at 2v / Fully open at 10v (factory default)  
 On=Fully open at 2v / Closed at 10v.

Displays in degrees Fahrenheit.  
 On=°C  
 Off=°F (factory default)

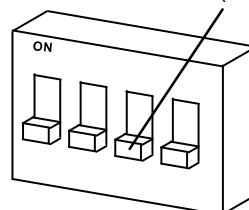
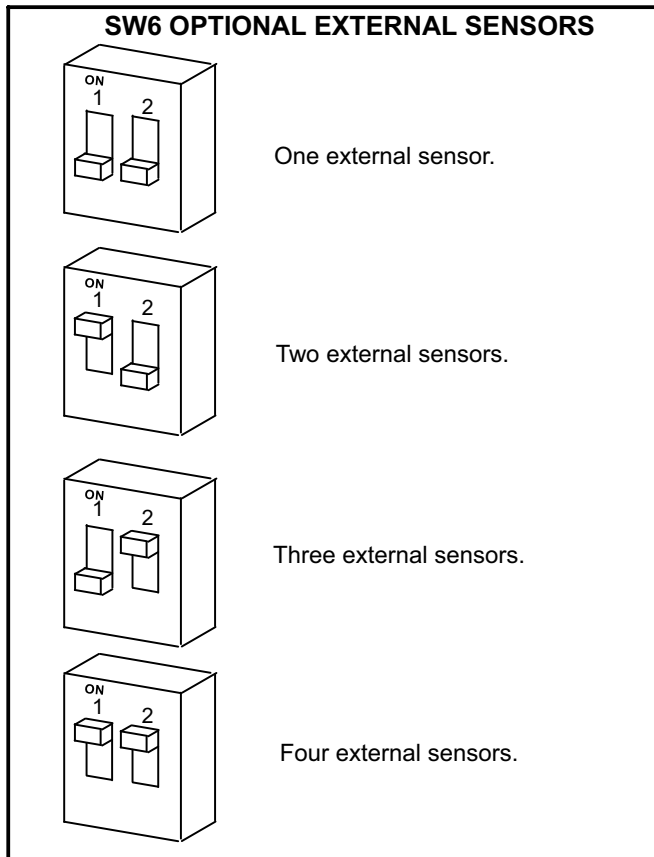

FIGURE 7



One external sensor.

Two external sensors.

Three external sensors.

Four external sensors.

### Comfort Sensor-Zoning Configuration

The following optional settings (M2 ECTOs or M3 Parameters) can be adjusted using Unit Controller software, a PC with first generation UC software, and L Connection PC converter. See figure 9. Settings do not have to be adjusted for zoned system operation; default parameters will be used. See table 2 for additional M2 ECTOs or M3 Parameters information.

*Note - One exception is the installation of a zone terminal box. Heat Type and Fan Type must be set.*

Connect the L Connection PC Converter phone cable to the Network Control Panel (NCP) to configure all of the CSZ. When the converter is connected to the CSZ, only the Controllers on that Zone Bus can be adjusted.

#### Main Screen Display Options

- Setpoint High Resolution
- Zone Temperature High Resolution
- CO2 Display
- Outdoor Temperature
- Temperature Setpoints
- RH
- Damper Position
- Momentary Backlight - Display backlight intensity within 5 seconds of button being pressed.
- Continuous Backlight - Display backlight intensity all of the time.

#### Fan Type

Terminal Box Fan Type - none, series, parallel

#### Heat Type

Zone Heat Type - none, terminal box, auxiliary, peripheral.

#### Heating

Heating votes (1st stage: 2nd stage).

0:0 - No votes (no affect on system heating demands).

0:1 - Vote only when sensing high zone heating demand.

1:1 - Vote single weight vote during either low or high zone heating demand.

1:2 - Vote single weight during low zone heating demand, vote double weight during high demand.

Heating Differential 1 - Defines the temperature below setpoint that creates a low heating demand.

Heating Differential 2 - Defines the temperature below setpoint that creates a high heating demand. Must be greater than Differential 1.

Heating Deadband - Defines the temperature above demand start temperature that ends the demand.

Heating Integration Constant - The integration time, in seconds, that is used in the damper position control algorithm during a zone heating demand.

Heating Proportional Constant - The proportion band, in degrees Fahrenheit, that is used in the damper control algorithm during a zone heating demand.

Heating Supply Air Temperature Differential - The amount warmer that the supply air temperature must be than the zone temperature, to be used for a heating demand.

#### Damper

Minimum zone damper position.

Maximum zone damper position.

Zone damper ventilation position.

Zone control loop reset position (damper starting position).

Zone CO<sub>2</sub> setpoint for ventilation (IAQ / indoor air quality ventilation setpoint 500-2000ppm of CO<sub>2</sub>).

#### Cooling

Cooling Votes (1st Stage; 2nd Stage)

0:0 - No votes (no affect on system cooling demands)

0:1 - Vote only when sensing high zone cooling demand.

1:1 - Vote single weight vote during either low or high zone cooling demand.

1:2 - Vote single weight during low zone cooling demand, vote double weight during high demand.

Cooling Differential 1 - Defines the temperature above setpoint that creates a low cooling demand.

Cooling Differential 2 - Defines the temperature above setpoint that creates a high cooling demand. Must be greater than Differential 1.

Cooling Deadband - Defines the temperature below demand start temperature that ends the demand.

Cooling Integration Constant - The integration time, in seconds, that is used in the damper position control algorithm during a zone cooling demand.

Cooling Proportional Constant - The proportion band, in degrees Fahrenheit, that is used in the damper control algorithm during a zone cooling demand.

### Setpoint Range and Sensor Calibration

Setpoint adjustment range except when zone is in manual mode.

Internal temperature offset calibration.

External temperature offset calibration.

RH offset calibration.

## Troubleshooting

Make sure the CSZ is displayed on the NCP network list. If the CSZ is not displayed:

- 1.. Make sure 24VAC is supplied to the CSZ.
- 2.. Make sure the CSZ address switch setting is different from all other CSZs on its ZoneBus.
- 3.. Check communication cable wiring: the red or + lead should be connected to CSZ terminal 9. The black or - lead should be connected to CSZ terminal 8.

Make sure connections are correct at the Zone Link and unit.

Verify communication using LEDs on the Zone Link and IMC or NTC.

- 4.. Make sure the IMC or NTC is setup for zoning application. Refer to the Zone Link installation instruction.
- 5.. Repoll the network at the NCP (see NCP user's manual).

Verify that the sensor data from the CSZ display matches the NCP zone data screen.

## Configuring the M3 Unit Controller for use with Comfort Sensors

To **enable** the M3 Unit Controller to use Comfort Sensors, use the following procedure:

- 1.. Go to **SETUP** and select **NETWORK INTEGRATION**.
- 2.. Use the **Adjust and set values** arrows to display **L-CONNECTION** and press the **SAVE** button to continue.
- 3.. Adjust the **L-CONNECTION ADDRESS** if required and press **SAVE** button to continue.

*NOTE: Both the L-Connection address setting and Comfort Sense address setting needs to be exactly the same. In addition, the Comfort Sense should be configured with NO NCP option.*

4.. **CONTROL MODE** will need to be set to **ROOM SENSOR**. Press the **SAVE** button to continue.

5.. **NETWORK SENSOR > CO2** needs to be set to **YES** if needed. Press the **SAVE** button to continue.

6.. **NETWORK SENSOR > RELATIVE HUMIDITY** needs be set to **YES** if needed. Press the **SAVE** button to continue.

7.. **NETWORK SENSOR > TEMPERATURE** will need to be set to **YES** (mandatory).

*NOTE: Additional settings will be required to complete after completing step 7. Once the above steps are completed the Comfort Sensor output will be accepted by the system.*

*NOTE: If Comfort Sensor input is still not working, cycle power to the M3 Unit Controller.*

## UNIT CONTROLLER SOFTWARE CONFIGURATION SCREEN (FIRST GENERATION UC SOFTWARE VERSION)

Comfort Sensor ECTO Parameters & CO2 Calibration
\_ □ ×

File Help

Address: **9 Gas/Electric RTU - CSZ1 -**
Controller Type: **CSZ 2.01**

ECTO
CO2 Calibration

Load ECTO
Save ECTO
Default ECTO

Upload ECTO to Comfort Sensor

**Display**

Data display option for main screen.  
The following options may be selected.

Setpoint High Resolution

Zone Temp. High Resolution

CO2

Outdoor Temperature

Setpoints

RH

Damper

---

Disable Override Button

Sets the brightness backlight for both "momentary" and "continuous"

Momentary is period after button is pressed. Continuous is all the time.

Continuous Backlight

2

Momentary Backlight

6

**Fan Type**

Terminal box fan type

None

Series

Parallel

**Heat Type**

Zone heat type

None

Terminal Box Heat

Auxiliary Heat

Peripheral Heat

**Heating**

Heating votes (1st Stage : 2nd Stage)

0 : 0       1 : 1

0 : 1       1 : 2

First heating setpoint differential

0.5 deg.F

Second heating setpoint differential

1 deg.F

Heating deadband

2 deg.F

Heating integration constant

1200 sec

No heating integration

Heating proportional constant

4 deg.F

No PI control, damper operates at reset value

Supply air differential before suitable for heating

10 deg.F

**Damper**

Minimum zone damper position

20 %

Maximum zone damper position

100 %

Damper ventilation position

60 %

Damper control loop reset position

50 %

Zone CO2 setpoint for ventilation

Turn off Zone CO2 setpoint for ventilation position

**Cooling**

Cooling votes (1st Stage : 2nd Stage)

0 : 0       1 : 1

0 : 1       1 : 2

First cooling setpoint differential

0.5 deg.F

Second cooling setpoint differential

1 deg.F

Cooling deadband

2 deg.F

Cooling integration constant

1200 sec

No cooling integration

Cooling proportional constant

4 deg.F

No PI control, damper operates at reset value

**Setpoint Range & Sensor Calibrations**

Setpoint adjustment range except when zone is in manual mode.

4 deg.F

Internal temperature sensor calibration

0 deg.F

External temperature sensor calibration

0 deg.F

RH sensor calibration offset

0 %

FIGURE 9



**TABLE 2  
COMFORT SENSOR-ZONING PARAMETERS**

Control Parameter	Control Value			Units	Description
	Name	Min	Default		
DISPLAY_OPT	Default display is zone temperature only.			Option	Data display option for main screen. The following options may be selected. <b>(Comfort Sensor-Zoning equipped with optional display only).</b> Setpoint High Resolution Zone Temperature High Resolution CO2 Display Outdoor Temperature Setpoints RH Damper Position  Exceptions: 1-Cannot display Heating Setpoint and RH at the same time. 2-Cannot display Cooling Setpoint and Damper Position at the same time. 3-Cannot display CO <sub>2</sub> and OAT at the same time.
Momentary Backlight	0	6	15	Brightness	Sets the display backlight brightness 5 after the button is pressed. <b>(Comfort Sensor-Zoning equipped with optional display only).</b>
Continuous Backlight	0	2	15		Sets the display backlight brightness continuously. <b>(Comfort Sensor-Zoning equipped with optional display only).</b>
SP_ADJ_RANGE	0	2	10	DegF	Setpoint adjustment range except when zone is in manual mode.
INT_CAL	-5	0	+5	DegF	Internal temperature sensor calibration offset.
EXT_CAL	-5	0	+5	DegF	Internal temperature sensor calibration offset.
RH_CAL	-5	0	+5	%RH	RH sensor calibration offset.
CO2_CAL	-200	0	+200	PPM	CO <sub>2</sub> sensor calibration offset.
FAN_TYPE					Terminal box fan type - None, series, parallel.
HEAT_TYPE					Zone heat type - None, terminal box, auxiliary, peripheral.
DAMP_MIN	0	10	100	%	Minimum zone damper position.
DAMP_MAX	0	100	100	%	Maximum zone damper position.
DAMP_VENT	0	60	100	%	Damper position during demand control ventilation.
DAMP_RST	0	50	100	%	Damper control loop reset position.
DCV_SP	500	0	2000	PPM	Zone CO <sub>2</sub> setpoint for ventilation position. 0 = off.
VOTING_COOL	0:0	1:2	1:2	Votes	(1 <sup>st</sup> stage : 2 <sup>nd</sup> stage) 0 : 0, 0 : 1, 1 : 1, 1 : 2
CLG_DF1	0	.5	3	DegF	First cooling setpoint differential.
CLG_DF2	0	1	3	DegF	Second cooling setpoint differential.
CLG_DB	1	2	4	DegF	Cooling deadband.
CLG_TI	10	1200	2550	Sec.	Cooling integration constant. 0=no Integration.
CLG_PB	2	4	30	DegF	Cooling proportional constant. 0= no PI control; damper operates at reset value.
VOTING_HEAT	0:0	1:2	1:2	Votes	(1 <sup>st</sup> stage : 2 <sup>nd</sup> stage) 0 : 0, 0 : 1, 1 : 1, 1 : 2
HT_DF1	0	.5	3	DegF	First heating setpoint differential.
HT_DF2	0	1	3	DegF	Second heating setpoint differential.
HT_DB	1	2	4	DegF	Heating deadband.
HT_TI	10	1200	2550	Sec	Heating integration constant. 0=no I
HT_PB	2	4	30	Deg.F	Heating proportional constant. 0= no PI control; damper operates at reset value.
SA_DF	0	10	20	Deg.F	Supply air differential before suitable for heating.