

Installation Instructions for the Equipment Interface Module (EIM) (10T50) used with iComfort® Series Thermostat



IMPORTANT!

- The iComfort series thermostat paired with the Equipment Interface Module (EIM) will work with most 24VAC furnaces, air handlers, air conditioners and heat pumps (up to 2-stages of cooling and 3-stages of heat).
- The iComfort series thermostat without the Equipment Interface Module (EIM) will work with Lennox branded communicating HVAC equipment.

TABLE OF CONTENTS

Shipping and Packaging 1

Application and Requirements 1

Indoor Transformer Requirements 1

Equipment 1

Installation 3

Configuration Setup 3

EIM, 24VAC Furnace and iComfort Heat Pump 4

EIM, iComfort Furnace and 24VAC Heat Pump 4

Unit Type Jumpers 4

Heat Stage Jumper Positions 4

24VAC Heat Pump Size Setting 4

Air Temperature Sensor Connections 5

iComfort Terminal Connections 5

Heat Stage Jumpers 5

Dual-Fuel Terminal Connections 5

24VAC Terminal Connections 6

LEDs 6

Soft Disable 6

iComfort Wi-Fi Commissioning (24VAC) 7

iComfort S30 Smart Thermostat Commissioning (24VAC) 7

Operating Environment Specifications 7

Dual-Fuel Operations 8

EIM, 24VAC Furnace and iComfort Heat Pump 8

EIM, iComfort Furnace and 24VAC Heat Pump 9

Field Wiring 10

Alert Codes and Troubleshooting 17

⚠ WARNING

Improper installation, adjustment, alteration, service or maintenance can cause property damage, personal injury or loss of life.

Installation and service must be performed by a licensed professional HVAC installer (or equivalent) or service agency.

Shipping and Packaging

- 1 - Equipment interface module with housing (10T50)

Application and Requirements

Indoor Transformer Requirements

Table 1 lists the required indoor unit transformer rating (VA) for specific configurations.

Equipment

The EIM is used with an iComfort series thermostat (iComfort Wi-Fi or iComfort S30) using the R, i+, i-, and C terminals and is the interface between non-RSBus HVAC equipment and RSBus-enabled (communicating) HVAC equipment. The control supports the following equipment applications:

NOTE: EIM will support single-stage outdoor units and single-stage or variable-stage indoor furnaces.

Table 1. System VA Loading Chart

Configuration	Minimum Transformer Rating (VA)
2-Stage HP, 3-Stage Electric heat	70
2-Stage HP, 2-Stage Furnace (with tempering)	70
2-Stage HP, 2-Stage Furnace (without tempering)	50
2-Stage AC, 2-Stage Furnace	40

Table 2. Wiring Diagrams

SYSTEM	INDOOR UNIT	OUTDOOR UNIT	DIAGRAM
AIR CONDITIONER	24VAC CONVENTIONAL	24VAC CONVENTIONAL	Figure 7
HEAT PUMP	24VAC CONVENTIONAL	24VAC CONVENTIONAL	Figure 7
DUAL FUEL	24VAC CONVENTIONAL	ICOMFORT®-ENABLED	Figure 8
DUAL FUEL	ICOMFORT®-ENABLED	24VAC CONVENTIONAL	Figure 9
DUAL FUEL	24VAC CONVENTIONAL	24VAC CONVENTIONAL	Figure 10
DUAL FUEL WITH IHARMONY®	ICOMFORT®-ENABLED	24VAC CONVENTIONAL	Figure 10
BASEBOARD HEAT	24VAC CONVENTIONAL*	ICOMFORT®-ENABLED	Figure 11
HOT WATER COIL WITH AQUASTAT BLOWER CONTROL	24VAC CONVENTIONAL(ICOMFORT®-ENABLED	Figure 11
ACCESSORIES - DEHUMIDIFIERS, HUMIDIFIERS, HEPA BYPASS FILTER - HRV / ERV	24VAC CONVENTIONAL		Figure 12
ACCESSORIES - EDA HUMIDITROL® - LVCS VENTILATION CONTROL	24VAC CONVENTIONAL	24VAC CONVENTIONAL	Figure 13

* 24VAC conventional air handler or CBX32MV(-6) / CBX40UHV used as 24VAC conventional.

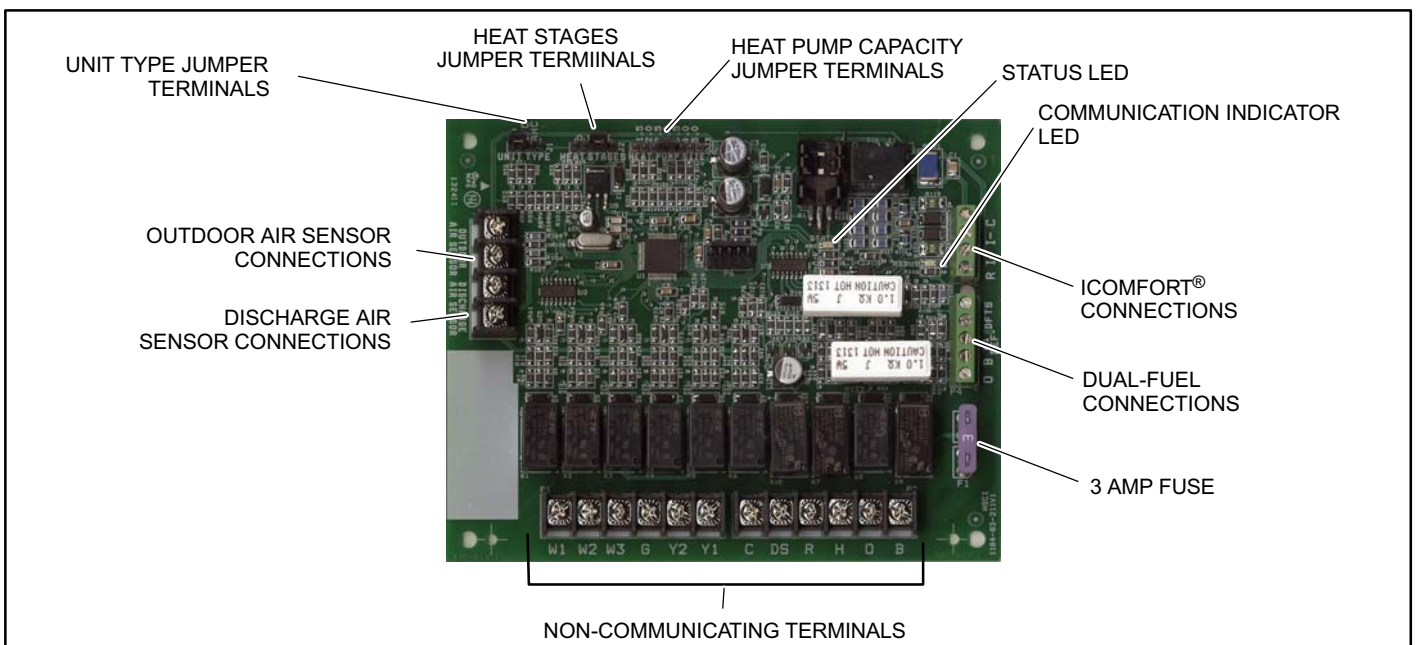
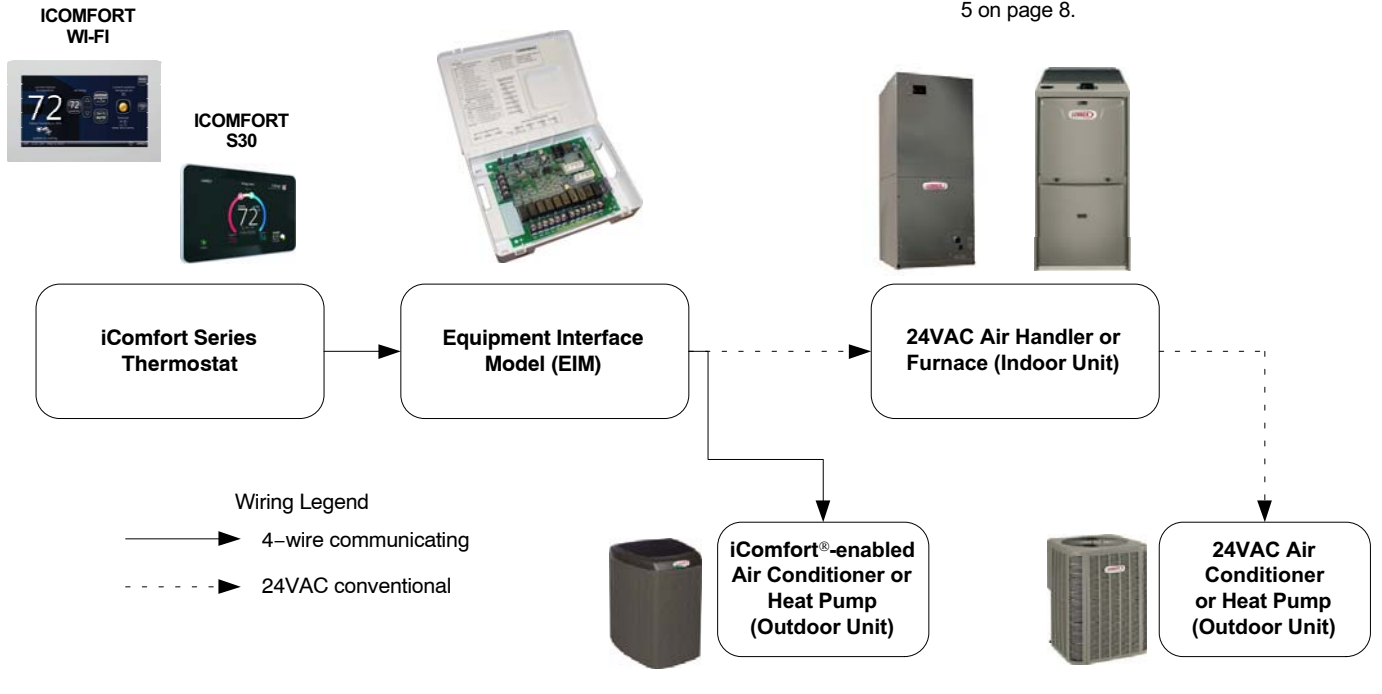

Figure 1. Equipment Interface Module (EIM) Terminals and LEDs

EIM with Air Handler or Furnace (Indoor Unit) and either a Air Conditioner or Heat Pump (Outdoor Unit)

NOTE: For dual-fuel applications, additional components may need to be added, see figure 5 on page 8.



Installation

⚠ CAUTION

Controls in this module are sensitive to moisture. Do NOT secure this module to the sheet metal cabinet where moisture may condense during periods of high humidity. Secure the module to a nearby wooden stud, if possible.

⚠ CAUTION

Electrostatic discharge can affect electronic components. Take precautions during unit installation and service to protect the unit's electronic controls. Precautions will help to avoid control exposure to electrostatic discharge by putting the unit, the control and the technician at the same electrostatic potential. Neutralize electrostatic charge by touching hand and all tools on an unpainted unit surface before performing any service procedure

ICOMFORT WI-FI

1. Remove the module cover.
2. Mount the Equipment Interface Module (EIM) near the indoor unit.
3. Use the provided wiring diagrams (figures 7 through 13) to complete the wiring connections for the specific application and configuration.

Configuration Setup

Configure the EIM based on the components used in the system.

NOTE: Changing jumper positions after the control has been powered-up requires recommissioning for the change to be recognized.

NOTE: When the Equipment Interface Module is replaced, recommissioning the iComfort series thermostat will also need to be re-accomplished. See the iComfort series thermostat Setup Guide for recommissioning procedure.

NOTE: For using the equipment interface module in dual-fuel mode, see page 8.

EIM, 24VAC Furnace and iComfort Heat Pump

1. Set the EIM **Unit Type Jumper** to **IFC**.
2. Set the EIM **Heat Stage Jumper** to the applicable number of furnace heat stages.
3. Use the iComfort series thermostat to complete the commissioning procedure

EIM, iComfort Furnace and 24VAC Heat Pump

1. Set the EIM **Unit Type Jumper** to **Heat Pump**.
2. Set the EIM **Heat Stage Jumper** to the applicable number of heat pump heating stages.
3. Wire according to figure 10.
4. Use the iComfort series thermostat to complete the commissioning procedure

NOTE: For two-stage heat pump go to the heat pump outdoor control, locate J2 - 2ND STAGE LOCKIN and disable this function by removing the installed jumper and relocating it to one pin only.

Unit Type Jumpers

Set the *unit type* jumper for the type of indoor unit being used (see figure 2 and table 4). The factory default setting is **IFC**. If jumper is missing from header, alarm **130** is activated.

Table 3. Unit Type Jumpers Positions

Jumper Position	Indoor Unit	Outdoor Unit
HP	iComfort furnace	24VAC non-communicating heat pump
IFC	24VAC furnace	24VAC non-communicating air conditioner or heat pump
AHC	24VAC air handler	

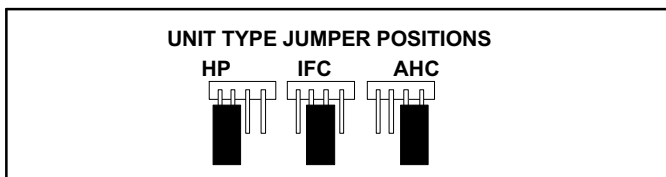

Figure 2. Unit Type Jumper Positions

Table 4. Unit Type Jumpers

Label	Function / Description
HP	Equipment Interface Module—Heat Pump
IFC	Equipment Interface Module—Furnace (factory default)
AHC	Equipment Interface Module—Air Handler

Heat Stage Jumper Positions

The heating staging Jumper must be set for the number of stages of electric heat (air handler) or the number of stage of gas heat (furnace) and stages of heat pump. Using the heat stages jumper (see figure 3 and table 8).

The factory default setting is **position 2**. If jumper is missing from header, alarm **130** is activated.

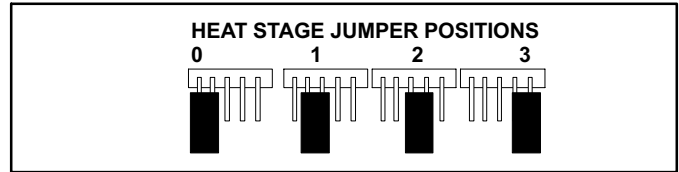

Figure 3. Heat Stages

24VAC Heat Pump Size Setting

Heat pump size must be configured when using a non-communicating heat pump using the Heat Pump Size jumper (see figure 4 and table 5). Factory default setting is for **3.0** (3-ton). If jumper is missing from header, alarm **130** is activated.

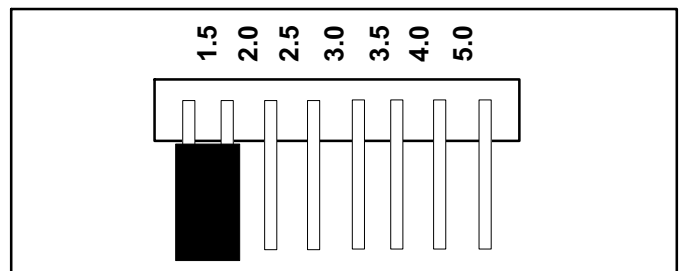

Figure 4. Heat Pump Size Jumper Positions

Table 5. 24VAC Heat Pump Capacity Jumper Setting

Label	Function / Description
1.5	1-1/2-ton
2.0	2-ton
2.5	2-1/2-ton
3.0	3-ton
3.5	3-1/2-ton
4.0	4-ton
5.0	5-ton

Air Temperature Sensor Connections

See figure 1 for location of the various terminals.

Table 6. Air Temperature Sensor Connections

Label	Function / Description
Outdoor Air Sensor	Show ambient temperatures (optional if weather feed is acceptable or outdoor unit is a communicating unit; use X2658 Outdoor Sensor - 2 terminals). <i>NOTE: Wiring distance between the EIM and the outdoor temperature sensor can not exceed 200 feet when wired with 18AWG thermostat wire.</i>
Discharge Air Sensor	Optional for diagnostics of indoor air; use 88K38 Discharge Air Sensor - 2 terminals.

Heat Stage Jumpers

Use table 8 to set the heat stage jumpers.

Table 8. Heat Stage Jumpers

Label (Position)	Air Handler Heat Stages		Furnace Heat Stages		Heat Pump Stages	
	Number of Electric Heat Stages	Stage Percentage	Number of Gas Stages	Stage Percentage	Number of Compressors Stages	Stage Percentage
0	No Electric Heat	0	1	100%	1	100%
1	1	100%	1	100%	1	100%
2 (Default)	2	50%, 100%	2	70%, 100%	2	70%, 100%
3	3	33.5%, 66.5%, 100%	2	70%, 100%	2	70%, 100%

NOTE: If jumper is missing, setting defaults to single stage. Changing jumper position after power-up requires recommission for the change to be recognized.

Dual-Fuel Terminal Connections

Table 9. Dual-Fuel Terminals

Label	Function / Description	
DFTS	Pre-coil discharge air temperature (2 terminals)	The pre-coil discharge air sensor should be installed downstream of the gas heat exchanger and before the indoor coil when a heat pump is used and defrost tempering is required. It must be placed in free airflow, where other accessories (such as humidifiers, UV lights, etc.) will not interfere with its accuracy. Wiring distance between the EIM and the discharge air sensor should not exceed 10 feet when using 18AWG thermostat wire.
W1-DEF	Defrost signal input	This input is used in systems with non-communicating heat pumps for defrost indication. The input provides a nominal load of 50 mA, 24 VAC.
O	Heat Pump Reversing Valve (Powered for cooling)	In systems with communicating IFC, the EIM (HP) O output is connected to a non-communicating heat pump compatible with O signal for reversing valve operation. A 24VAC signal is generated on O for cooling operation, while the terminal is open for heating operation.
B	Heat Pump Reversing Valve (Powered for heating)	In systems with communicating IFC, the EIM (HP) B output is connected to a non-communicating heat pump compatible with B signal for reversing valve operation. A 24VAC signal is generated on B for heat pump operation, while the terminal is open for cooling operation.

iComfort Terminal Connections

Table 7. iComfort® Terminals

Label	Function / Description
R	24VAC communication power Input
i+	Communication high – data line
i-	Communication low – data line
C	24VAC communication common power Input

24VAC Terminal Connections

Table 10. Non-Communicating Terminals (Conventional)

Label	Function / Description	
W1	1 st - stage heat output (1 st stage gas heat output when configured as IFC and 1 st stage electric heat output when configured as AHC).	
W2	2 nd - stage heat output (2 nd stage gas heat output when configured as IFC and 2 nd stage electric heat output when configured as AHC).	
W3	3 rd - stage heat output (3 rd stage electric heat output when configured as AHC)	
G	Indoor blower control (continuous fan) (monitoring only). G input may be connected to IAQ devices such as LVCS, HRV or ERV to turn the indoor blower on and off.	
Y2	2 nd - stage compressor output	
Y1	1 st - stage compressor output	
DS	24VAC dehumidification signal output. The DS terminal is powered when there is not a dehumidification call.	
C	Class II, 24VAC transformer common	R and C terminals are used to receive power from the indoor unit and capable of providing the power to the EIM and all the associated loads. The R power input uses a 3A fuse (Lennox part number 25J4901).
R	Class II, 24VAC transformer power	
H	24VAC humidifier signal output	
O	Heat pump reversing valve (24VAC = cool)	Used as reversing valve output for heat pumps. The EIM uses a single-pole dual throw relay to generate O and B signals. Normally the O output is open and B output at 24VAC during heating calls. During cooling calls O is 24VAC and B open. With relay de-energized 24VAC is present on O terminal. When power off/ or control reset, 24VAC power shall not be present on the O terminal.
B	Heat pump reversing valve (24 VAC = heat)	

LEDs

This control has two green LED to indicate status and communication activity One LED is labeled **Status** and the other is labeled **RSBUS**.

RSBUS LED

The RSBus LED flashes when information is being communicated over the RSBus.

Status LED

The following table lists all status LED information.

Table 11. Status LED (Green)

Status LED (Green)	Function / Description
Steady On	Remains steady ON until the device sends its start-up message.
Blinks 3 second OFF and 1 second ON	Soft disable state
Blinks 2 second ON and 2 second OFF	Service is being provided (W, Y or G relay is ON, or G input ON)
Blinks 1 second ON and 1 second OFF	Alarm is present.

Soft Disable

Soft disabling is when iComfort® room thermostat finds an unknown control (indoor or outdoor unit control, iHarmony® zoning system or Equipment Interface Module (EIM) on the system communication bus. The room thermostat sends the unknown control a message to go into soft disable mode until properly configured.

The iComfort® room thermostat will not show any code for a soft disabled control. When soft disabling occurs only the control that has been disabled will display the blinking LED status. In this case, the control blinks three seconds OFF and one second ON.

Use the following procedure if the equipment interface module is displaying the soft disable code

1. Confirm proper wiring between all devices (Thermostat, EIM, indoor and outdoor)
2. Cycle power to the control that is displaying the soft disable code.
3. Press the **Lennox** icon on the thermostat home screen and hold until the installer warning screen appears.
4. Press **yes** to continue.
5. Press **Setup** and then **confirm** to continue.
6. Use this Thermostat? Press **press here** button to continue.
7. Press the **next** button to continue pass the next three screens.
8. From the **System Devices** list, press **reset ALL** to reset all devices.
9. Press the **confirm** button

The thermostat will reboot and start through the setup process again.

IMPORTANT

If any jumpers were set incorrectly AFTER commissioning was completed, then reposition jumpers to correct positions. Re-running the commissioning procedure will be required at the iComfort series thermostat.

iComfort Wi-Fi Commissioning (24VAC)

Both unit capacity and number of compressor stages are required to be configured through the iComfort series thermostat. Once the outdoor unit has been installed and connected to the equipment interface module, go to the thermostat and start the configuration process.

1. From the **system devices** screen, press the **yes** button to add or remove non-communicating equipment.
2. A non-communicating device list will appear, select **Outdoor Unit Type** and then press **edit**.
3. Under **Outdoor Unit Type**, select the applicable 1 or 2-stage unit. Press **save** to continue.
4. Under **non-communicating device list**, select **Outdoor Unit Capacity** and then press **edit**.
5. Press either the **up** or **down arrows** to selected the applicable **Outdoor Unit Capacity**. Valid options are **18, 24, 30, 36, 42, 48** and **60**. Press **save** to continue.

This completes the configuring of the conventional 24V outdoor unit.

iComfort S30 Smart Thermostat Commissioning (24VAC)

Both unit capacity and number of compressor stages are required to be configured through the iComfort series thermostat. Once the outdoor unit has been installed and

connected to the equipment interface module, go to the thermostat and start the configuration process.

1. From the **equipment found** screen, press the non-communication equipment location to add **non-communicating** equipment.

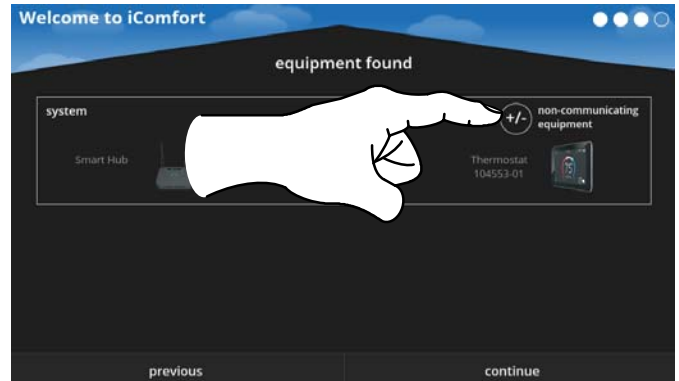

2. A add/remove equipment screen will appear. Under **Outdoor Unit Type**, select the applicable 1 or 2-stage unit.
3. Press either the **plus** or **minus** buttons to selected the applicable **Outdoor Unit Capacity**. Valid options are **18, 24, 30, 36, 42, 48** and **60**.
4. Press **save** to continue.

Operating Environment Specifications

The Equipment Interface Module is designed to operate in the following environmental conditions.

- **Operating Temperature Range:** -40°F to 176°F (-40°C to 80°C).
- **Shipping and Storage Temperature Range:** -40°F to 185°F (-40°C to 85°C).
- **Operating Humidity Range:** 10% to 90% non-condensing at 104°F.

Dual-Fuel Operations

To use the equipment interface module in dual-fuel mode, the following equipment combinations and configuration is required.

The DT1 (67M41) Discharge Temperature Probe is inserted in the furnace air outlet between the furnace and the indoor coil to keep furnace from overheating coil causing heat pump high pressure tripping during the defrost cycle. The DT1 is only needed with non-communicating furnaces (not required for air handlers). Wiring example for the DT1 Discharge Temperature Probe is exemplified in figure 9 on page 12.

EIM, 24VAC Furnace and iComfort Heat Pump

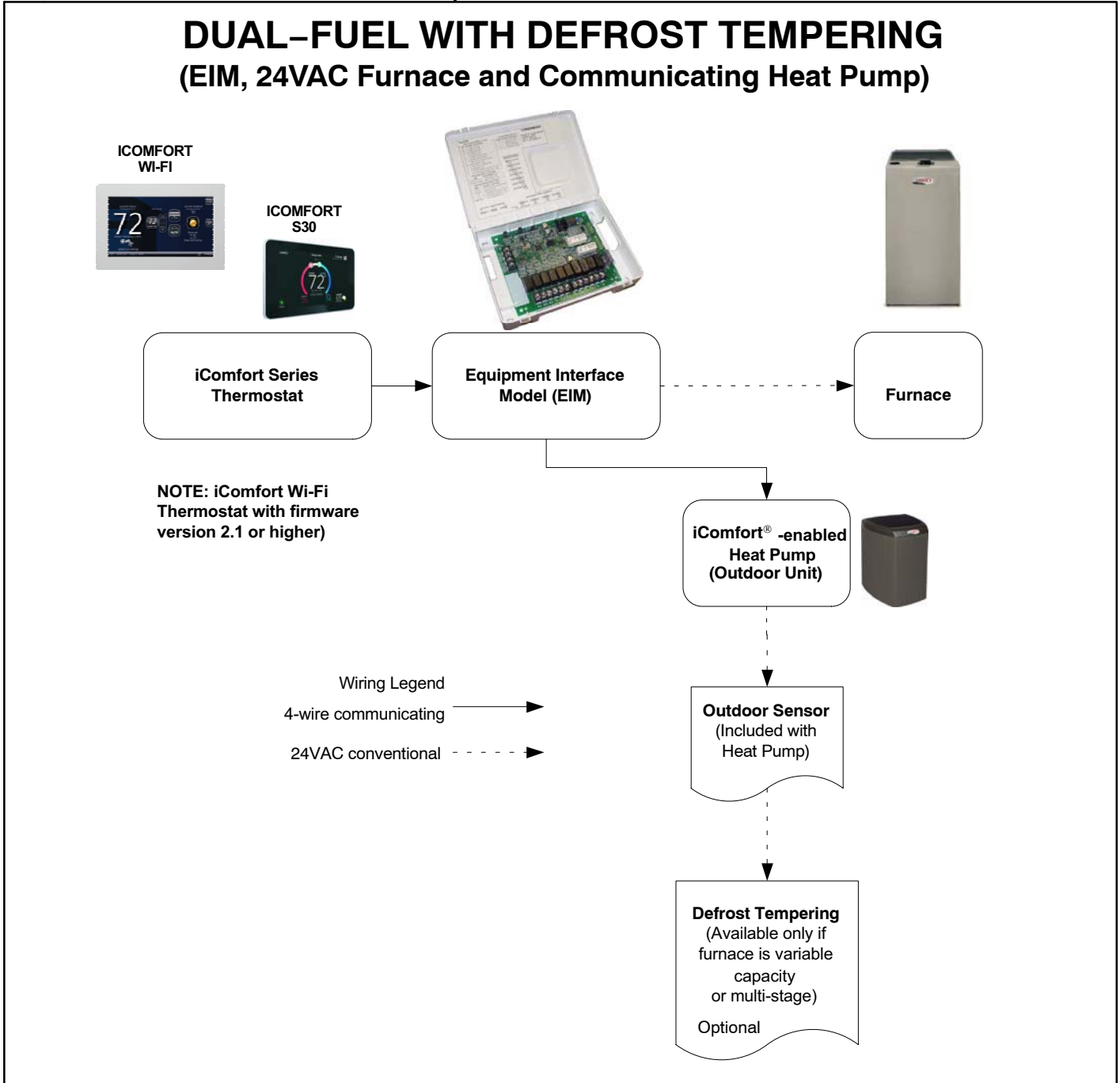

Figure 5

DUAL-FUEL WITH DEFROST TEMPERING (EIM, Communicating Furnace and 24VAC Heat Pump)

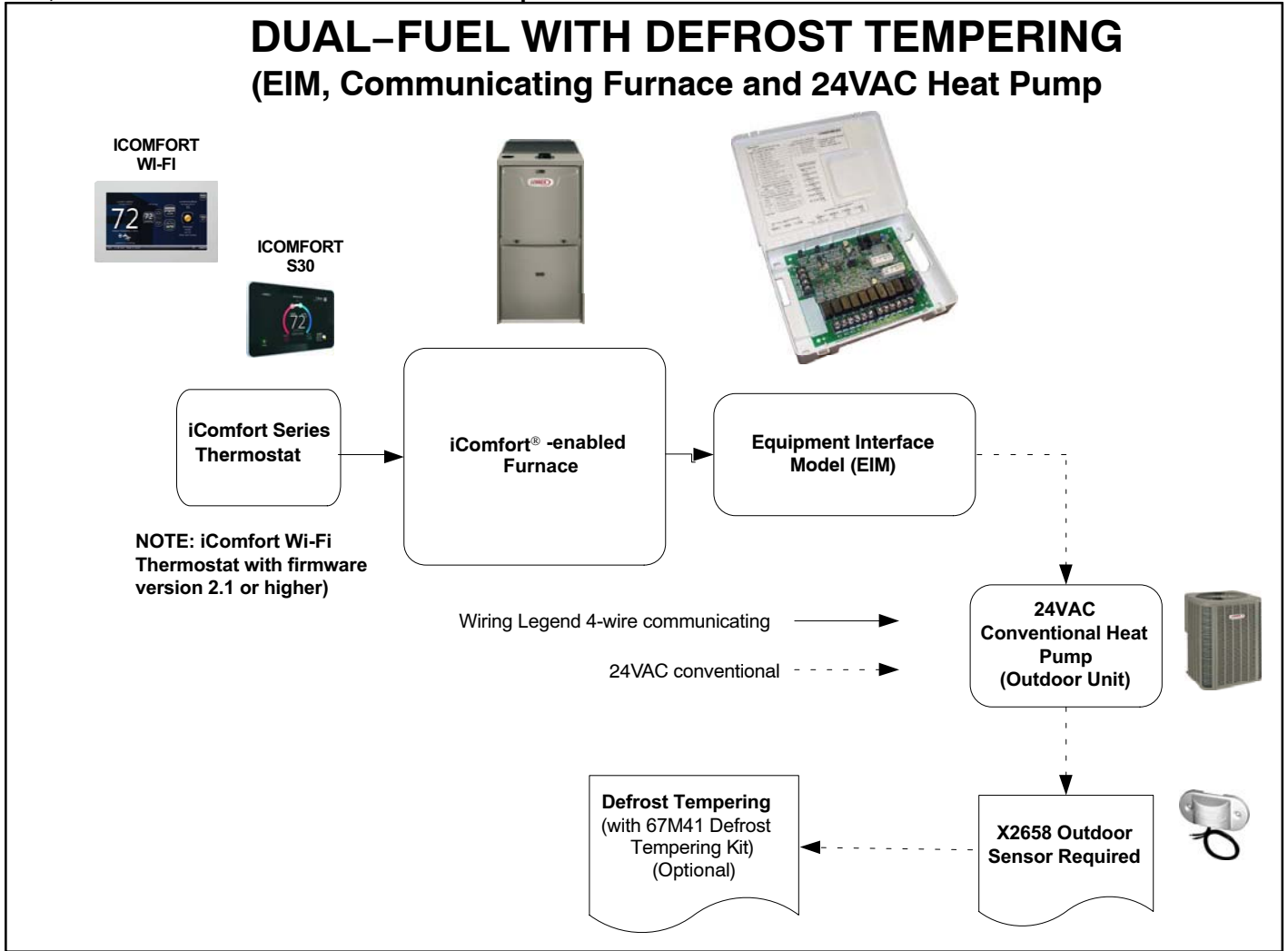

Figure 6

Field Wiring

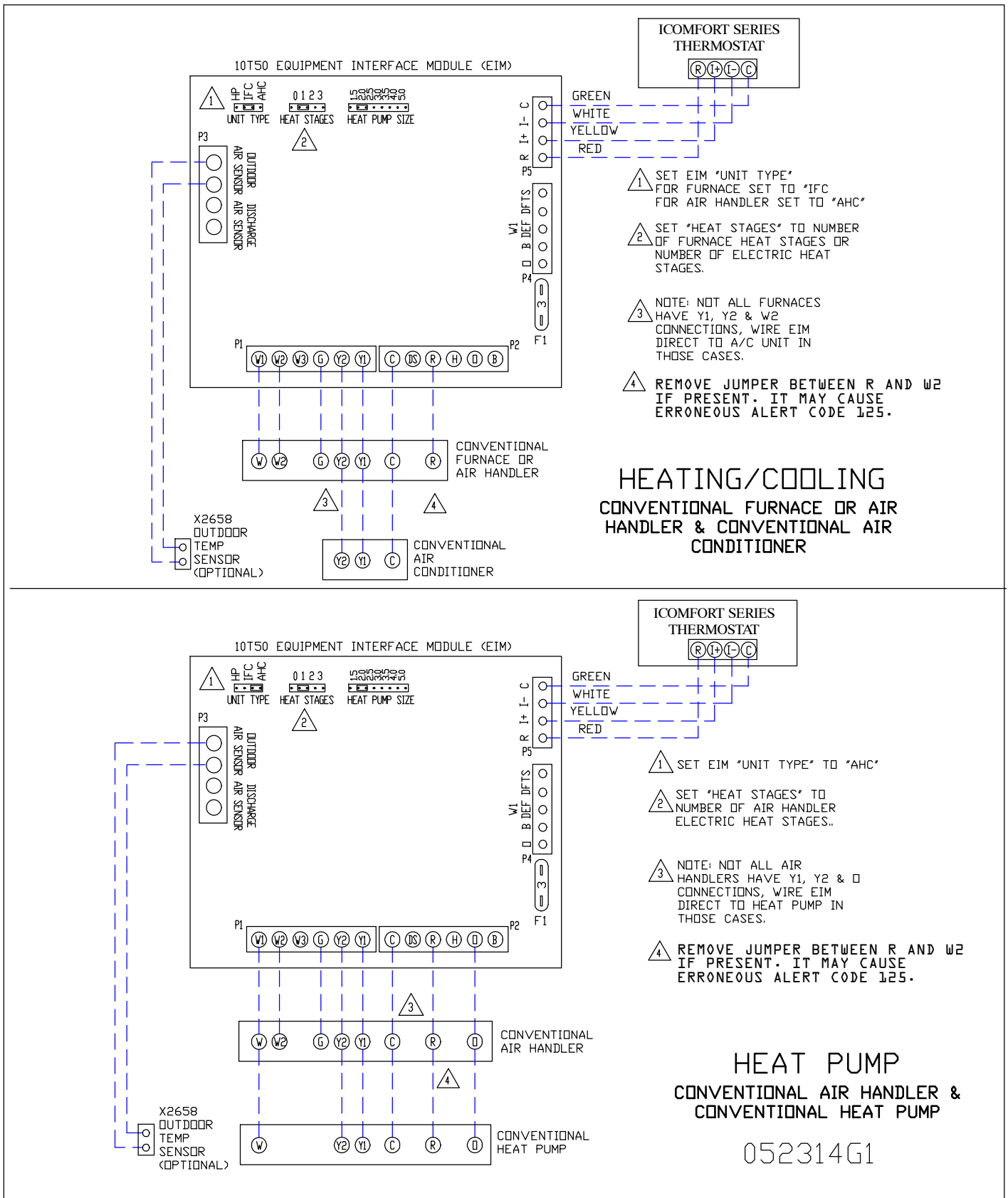

Figure 7

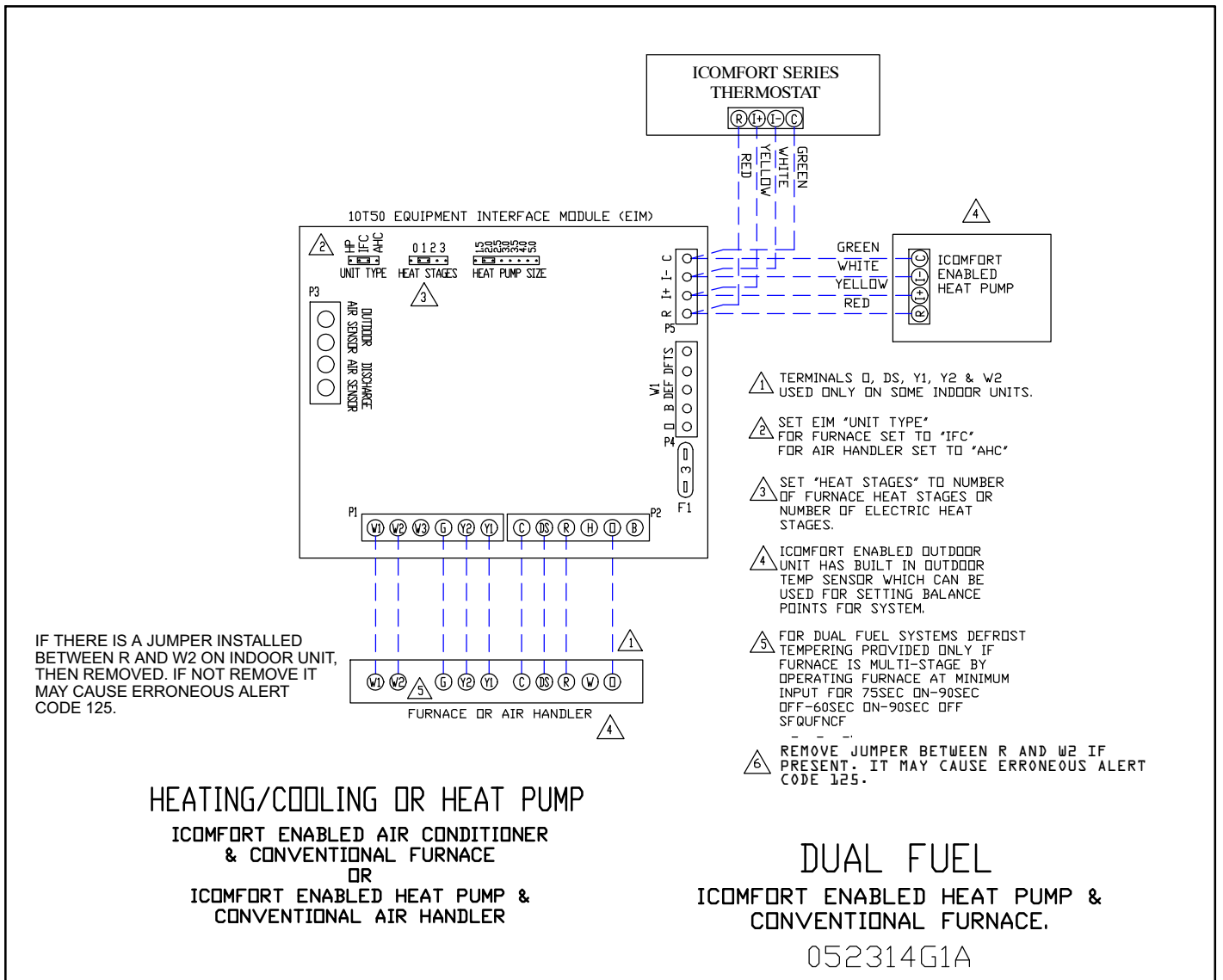
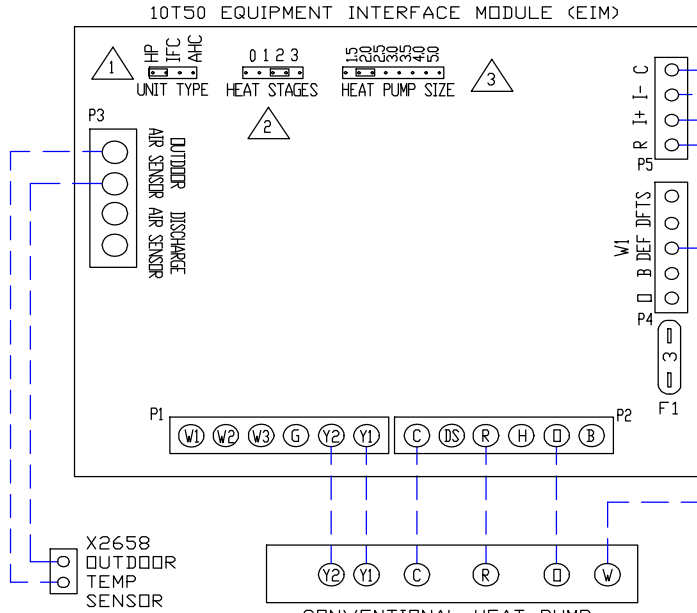

Figure 8

1 SET EIM "UNIT TYPE" TO "HP"

2 SET "HEAT STAGES" TO NUMBER OF COMPRESSOR HEAT STAGES.

3 SET "HEAT PUMP SIZE" TO CAPACITY IN TONS OF HEAT PUMP.



NOTE: DEFROST TEMPERING IS PROVIDED DURING DEFROST BY OPERATING THE FURNACE AT MINIMUM INPUT FOR 75 SEC ON-90SEC OFF-60 SEC ON- 90 SEC OFF SEQUENCE.

DUAL FUEL ICOMFORT ENABLED FURNACE & CONVENTIONAL HEAT PUMP

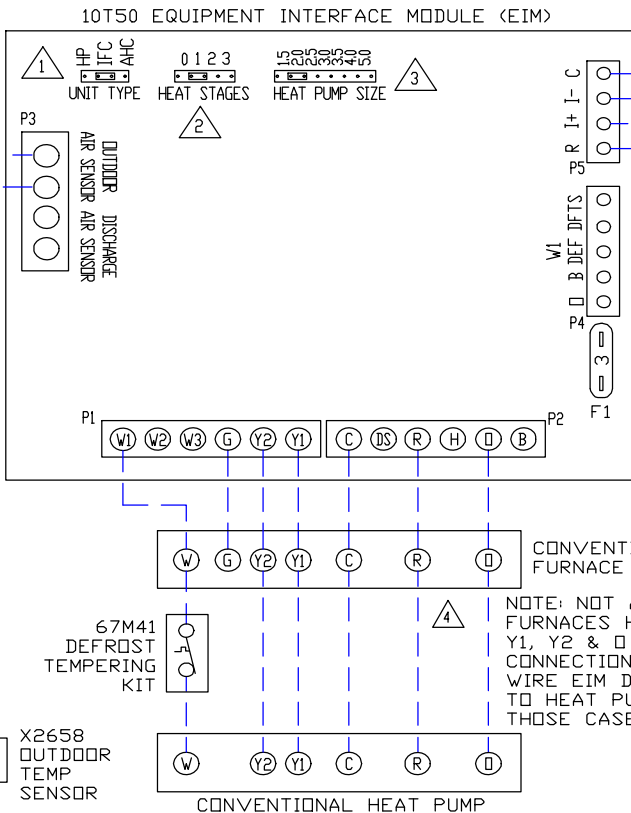

NOTE: DEFROST TEMPERING IS PROVIDED BY 67M41 DEFROST TEMPERING T'STAT-CYCLES FURNACE ON AT 80 DEGREES & OFF AT 90 DEGREES.

1 SET EIM "UNIT TYPE" TO "IFC"

2 SET "HEAT STAGES" TO NUMBER OF COMPRESSOR HEAT STAGES..

3 SET "HEAT PUMP SIZE" TO CAPACITY IN TONS OF HEAT PUMP.

4 REMOVE JUMPER BETWEEN R AND W2 IF PRESENT. IT MAY CAUSE ERRONEOUS ALERT CODE 125.

DUAL FUEL CONVENTIONAL FURNACE & CONVENTIONAL HEAT PUMP

NOTE: NOT ALL FURNACES HAVE Y1, Y2 & D CONNECTIONS, WIRE EIM DIRECT TO HEAT PUMP IN THOSE CASES.

052314G2A

Figure 9

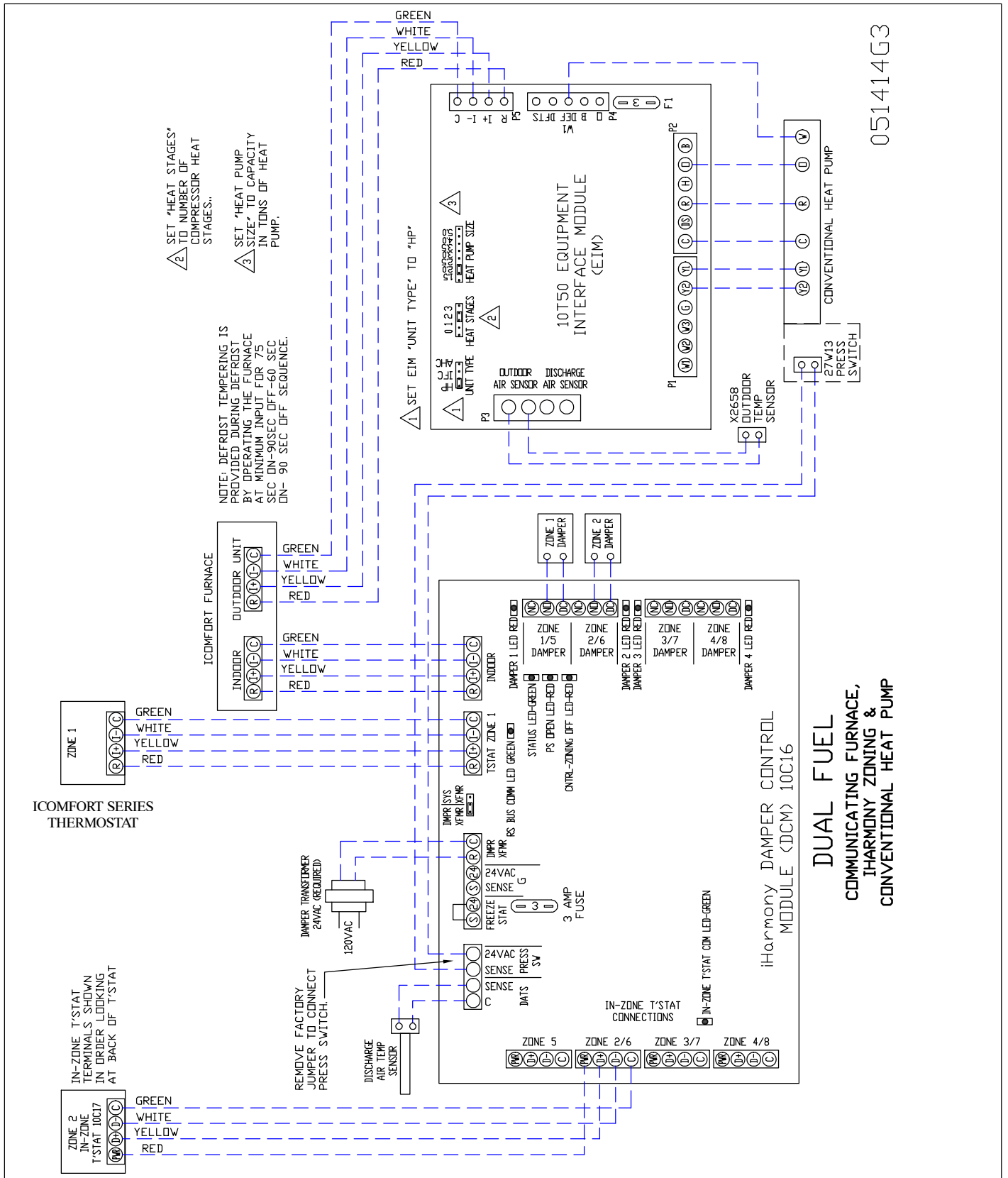

051414G3

Figure 10

⚠️ SET EIM "UNIT TYPE" TO "IFC" TO PREVENT FAN OPERATION DURING BASEBOARD HEATING OR UNTIL AQUASTAT CLOSES ON HOT WATER COIL HEAT.

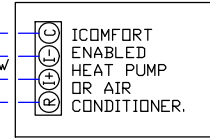
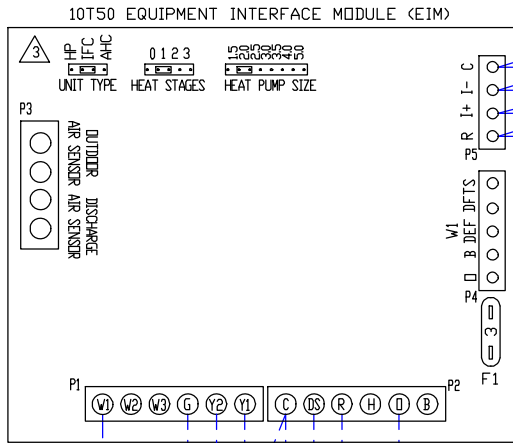
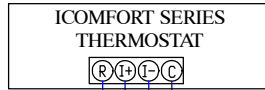

⚠️ TERMINALS U, DS, Y1 & Y2 USED ONLY ON SOME AIR HANDLERS.

⚠️ CBX32MV & CBX40UHV CUT ON BOARD LINKS: R-DS R-U

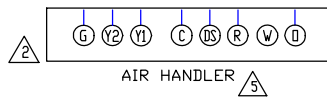
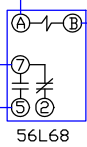
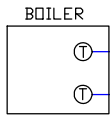

BASEBOARD HEAT
 ICOMFORT ENABLED HEAT PUMP OR AIR CONDITIONER & CONVENTIONAL AIR HANDLER OR CBX32MV(-6)/CBX40UHV USED AS NON-COMMUNICATING AIR HANDLER.

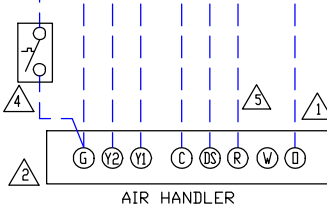
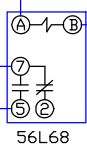
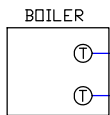
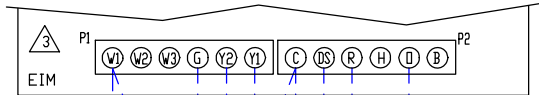

HOT WATER COIL HEAT WITH AQUASTAT BLOWER CONTROL
 052314G3

⚠️ AQUASTAT PROVIDED BY INSTALLER. SET AIR HANDLER CONTINUOUS FAN SPEED TO DESIRED HEATING CFM.

⚠️ REMOVE JUMPER BETWEEN R AND W2 IF PRESENT. IT MAY CAUSE ERRONEOUS ALERT CODE 125.

Figure 11

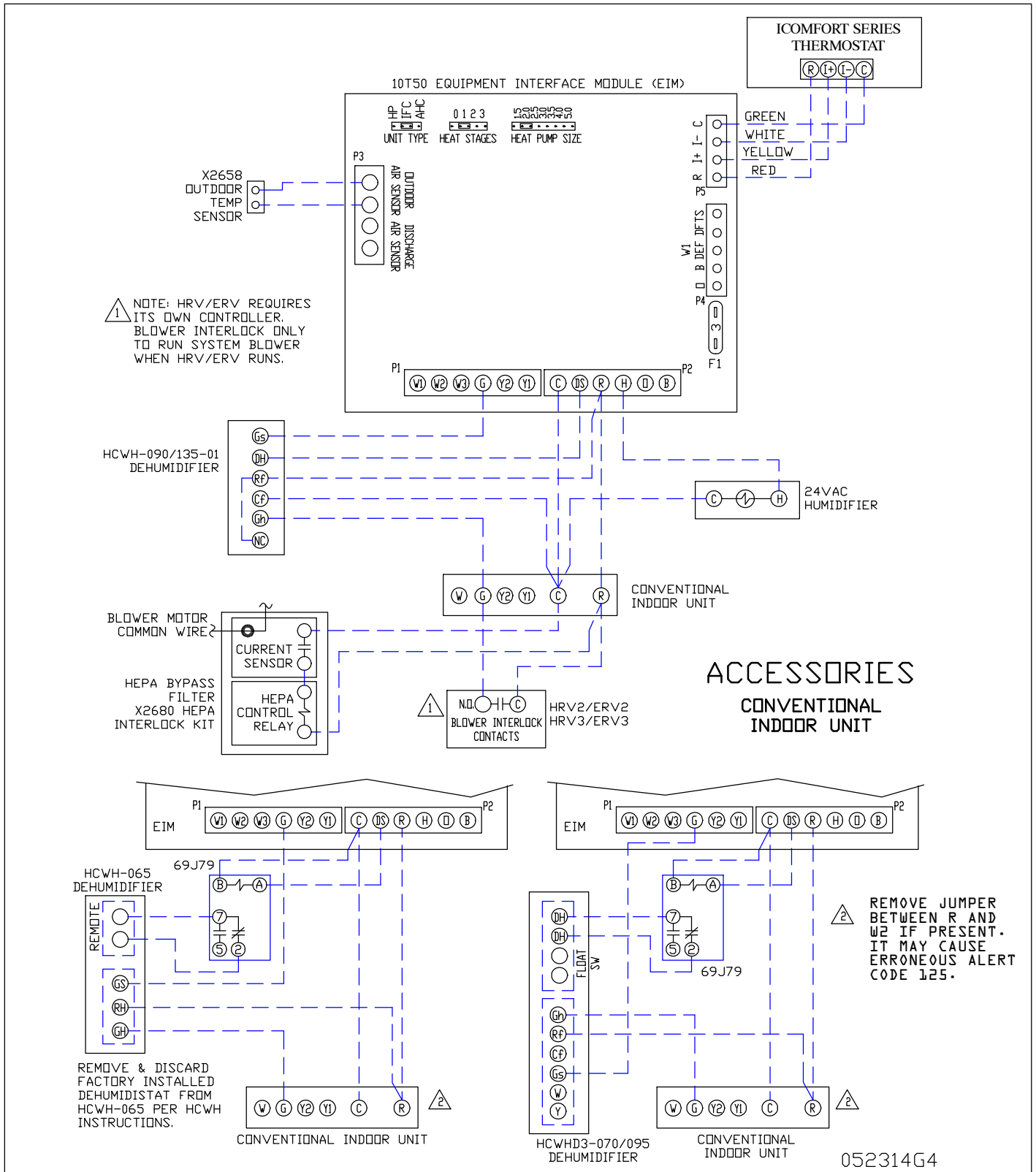

Figure 12

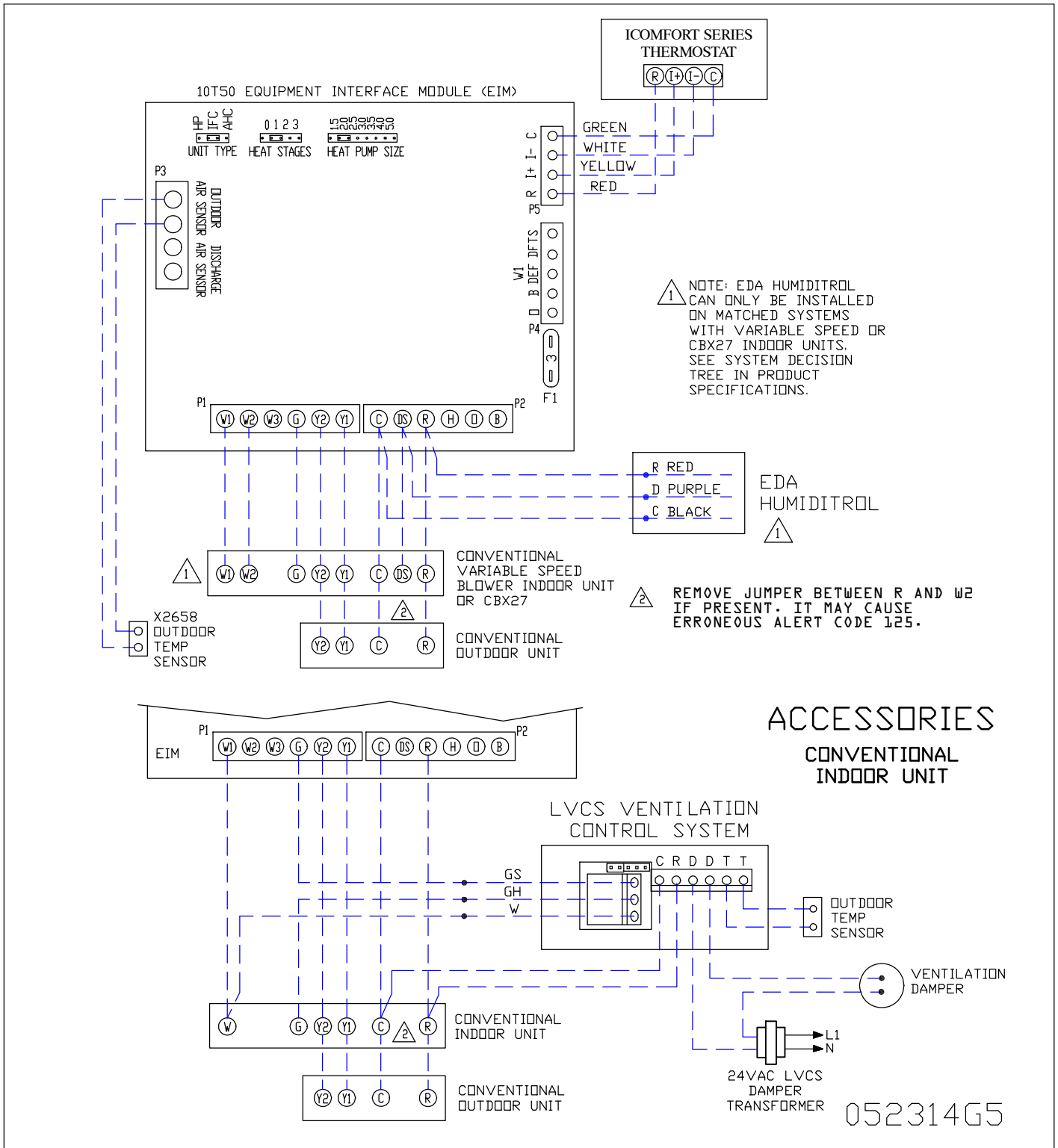

Figure 13

Alert Codes and Troubleshooting

Error codes are transmitted to the thermostat (see table 12). No codes are stored in the equipment interface module.

Table 12. Alert Codes and Troubleshooting				Critical alerts are displayed on the Home screen, in the Homeowner alert button, and in the Installer alert button. Minor and moderate alerts are found only in the Installer alert button.	
Alert Code	Priority Condition	Applicable System Components	Alert Text	Component or System Operational State and Troubleshooting Tip	How to clear alert code
10	Critical	All iComfort Series Thermostats, air handler, furnace, outdoor unit, equipment interface and IHarmony.	The thermostat has found an unknown device on the system.	<p>The iComfort Series Thermostats when NOT in configuration mode has detected an unknown device. Typically the thermostat will send a command to the unknown device and place it in a soft disable state. The soft disable control will indicate so as follows:</p> <ul style="list-style-type: none"> √ On air handler, furnace and outdoor controls, the state is displayed by double horizontal lines on seven-segment display. √ On the damper control module or equipment interface equipment, the green LED will blink three seconds on and one second off. <p>Cycling power to the soft disabled control may clear the condition. If cycling power does not clear the soft disable state then replace control.</p>	Clear alert code by reconfiguring the system.
12	Critical	All iComfort Series Thermostats, furnace, equipment interface module or air handler	The thermostat cannot find an iComfort® indoor unit.	<p>iComfort Series Thermostats did not find an indoor unit. Make sure there is an iComfort® indoor unit on the system.</p> <ul style="list-style-type: none"> √ Check R, i+, i- and C connections and voltages. √ Ohm wires and cycle power. √ Check for voltage and missing component. √ Verify that equipment interface module is configured as air handler or furnace when used with a non-communicating indoor unit. √ Go to menu > advance settings > view dealer control center > equipment and press reset all equipment. This will allow the system to auto-detect any iComfort® components attached. √ Replace indoor unit control if there is no response. 	Automatically clears when the system detects that the issue no longer exists.
105	Critical	All iComfort Series Thermostats, furnace, air handler, outdoor unit, equipment interface or IHarmony	A system component has lost communication with the system.	<p>System component (device) is unable to communicate.</p> <ul style="list-style-type: none"> √ This may indicate the existence of other active alert codes. √ In most cases errors are related to electrical noise. Verify that high voltage power is separated from the low voltage communication wires. √ Check for incorrectly wired or loose connections between system components (devices). √ Check for a high voltage source of noise close to the system. 	Automatically clears when the system detects the issue no longer exists.
114	Moderate / Critical	Furnace, air handler, equipment interface or IHarmony	There is a frequency / distortion problem with the power to a specific system component.	<ul style="list-style-type: none"> √ This alert code may indicate transformer overloading. √ Check the voltage and line power frequency. √ Check the generator operating frequency, if the system is running on back-up power. √ Correct voltage and frequency problems. √ System will resume normal operation five seconds after fault recovered. √ All applicable system component outputs are disabled – moderate condition. √ After 10 minutes, the priority condition is escalated – critical condition. √ Damper control module will operate in central mode only until proper voltage is restored or frequency distortion is resolved – moderate condition. 	Automatically clears when the system detects the issue no longer exists.

Table 12 Alert Codes and Troubleshooting				Critical alerts are displayed on the Home screen, in the Homeowner alert button, and in the Installer alert button. Minor and moderate alerts are found only in the Installer alert button.	
Alert Code	Priority Condition	Applicable System Components	Alert Text	Component or System Operational State and Troubleshooting Tip	How to clear alert code
115	Critical	Furnace, air handler or equipment interface module	Primary 24VAC power to a system component control is lower than the required range of 18 to 30VAC.	<ul style="list-style-type: none"> √ Check and correct voltage. √ Check for additional power-robbing system components (devices) connected to system. √ This alert code may require the installation of an additional or larger VA transformer. 	Automatically clears when the system detects the issue no longer exists.
120	Moderate	All iComfort Series Thermostats, furnace, air handler, outdoor unit, equipment interface or IHarmony	There is a delay in the system component responding to the system.	<p>Typically this alert code does not cause any operational issues and will clear on its own.</p> <ul style="list-style-type: none"> √ This alert code is usually caused by a delay in the outdoor unit responding to the thermostat. √ Check all wiring connections. 	Automatically clears after an unresponsive system component (device) responds to any inquiry.
124	Critical	All iComfort Series Thermostats, furnace, air handler, outdoor unit, equipment interface or IHarmony	The thermostat has lost communication with a system component for more than three minutes.	<p>System component has lost communication with the thermostat.</p> <ul style="list-style-type: none"> √ Check the wiring connections. √ Ohm wires. √ Cycle power. √ Check voltage at component. <p>This alert code stops all associated system operations and waits for a heartbeat message from the system component that is not communicating.</p>	Automatically clears after communication is re-established with applicable system component (device).
125	Critical	All iComfort Series Thermostats, furnace, air handler, outdoor unit, equipment interface or IHarmony	There is a hardware problem on a system component control.	<p>There is a control hardware problem.</p> <ul style="list-style-type: none"> √ Replace the control if the problem prevents operation and is persistent. √ Damper control module will remain in non-zone mode (all dampers open) for five minutes after priority condition no longer exist. √ Remove jumper if present on indoor unit between R and W2 if equipment interface module is in use. 	Automatically clears 300 seconds after the issue no longer exists.
130	Moderate	Equipment interface module	Air handler jumper is missing.	<ul style="list-style-type: none"> √ Configuration jumper missing on equipment interface module. √ Install the missing jumper. <p>NOTE: This is applicable in non-communicating applications only).</p>	Automatically clears after the missing or incorrectly installed jumper is installed or corrected.
131	Critical	All iComfort Series Thermostats, furnace, air handler, outdoor unit, equipment interface or IHarmony	System component control parameters are corrupted.	<ul style="list-style-type: none"> √ Replace the system component control if heating or cooling is not available. √ Try resetting the thermostat. 	Will automatically clear when system component (device) passes memory self-test or system component control is replaced.
132	Critical	Air handler, equipment interface module or IHarmony	System component control software is corrupted.	<ul style="list-style-type: none"> √ Recycle power. √ If failure re-occurs, replace the system component control. 	Manual system power reset is required to recover from this alert code.

Table 12. Alert Codes and Troubleshooting

Critical alerts are displayed on the Home screen, in the Homeowner alert button, and in the Installer alert button. Minor and moderate alerts are found only in the Installer alert button.

Alert Code	Priority Condition	Applicable System Components	Alert Text	Component or System Operational State and Troubleshooting Tip	How to clear alert code
180	Critical	Furnace, air handler or equipment interface module	The thermostat has found a problem with a system component's outdoor temperature sensor.	<p>In normal operation after system component control recognizes sensors, the alarm will be sent if valid temperature reading is lost.</p> <ul style="list-style-type: none"> √ Compare outdoor sensor resistance to temperature / resistance charts in unit installation instructions. √ Replace sensor pack if necessary. √ At the beginning of (any) configuration, furnace, air-handler control or equipment interface module will detect the presence of the sensor(s). √ If detected (reading in range), appropriate feature will be set as 'installed' and shown in the 'About' screen. 	Automatically clears upon configuration, or sensing normal values.
310	Moderate	Furnace, air handler equipment interface module or iHarmony	There is a discharge air temperature sensor issue.	<p>Compare discharge temperature sensor resistance to temperature / resistance charts in system component installation instruction.</p> <ul style="list-style-type: none"> √ Replace discharge air sensor if failed. √ If applicable, iHarmony will operate in non-zone mode (all dampers open). <p>NOTE: Confirm there is no short or open circuits in the iComfort thermostat connections to any of the other components in the communication system.</p>	Automatically clears 30 seconds after condition is detected as recovered or after system restart.
345	Critical	Air handler, equipment interface module or heat pump	The O relay on the system component has failed. Either the pilot relay contacts did not close or the relay coil did not energize.	<ul style="list-style-type: none"> √ Possible O relay / stage 1 failure. √ Pilot relay contacts did not close or the relay coil did not energize. √ Replace system component (device) control. √ If error is applicable to the XC/XP 25, the outdoor control will need to be replaced. 	Automatically clears after the fault recovered following reset.
347	Critical	Furnace, air handler or equipment interface module	The Y1 relay on the applicable system component has failed. Either the pilot relay contacts did not close or the relay coil did not energize.	<ul style="list-style-type: none"> √ System operation will stop. √ Possible Y1 relay / stage 1 failure. √ Pilot relay contacts did not close or the relay coil did not energize; √ There is no input back to the applicable system component control. 	Automatically clears after reset and Y1 input sensed.
380	Moderate / Critical	Equipment interface module	Interlock relay failure (IFC or AHC mode only).	<ul style="list-style-type: none"> √ Interlock relay is energized, but input is not sensed after three seconds. √ There will be no heating or cooling due to this alert code – moderate condition. √ De-energize interlock relay and energize after five minutes if demand is still present – critical condition. 	Automatically clears after fault recovered.
381	Moderate / Critical	Equipment interface module	Interlock relay stuck (IFC or AHC modes only)	<ul style="list-style-type: none"> √ Interlock relay continuously sensed (with relay off). √ There is no heating and cooling operation – moderation condition. √ After 10 minutes if event still exist it will be escalated – critical condition. 	Automatically clears 30 seconds after fault clears.
382	Moderate	Equipment interface module	Relay W1 failure (IFC and AHC modes only)	<ul style="list-style-type: none"> √ W1 relay is energized but input is not sensed after three seconds. 	Automatically clears when W1 relay input is sensed.

Table 12. Alert Codes and Troubleshooting				Critical alerts are displayed on the Home screen, in the Homeowner alert button, and in the Installer alert button. Minor and moderate alerts are found only in the Installer alert button.	
Alert Code	Priority Condition	Applicable System Components	Alert Text	Component or System Operational State and Troubleshooting Tip	How to clear alert code
418	Moderate	Equipment interface module and outdoor unit	There is a faulty W output circuit.	<ul style="list-style-type: none"> √ W terminal is energized <u>while in cooling mode</u>. √ Possible cause may be a stuck closed relay on the control, or something external to the control that is energizing W terminal when it should not be energized. √ Disconnect any wiring from the W terminal. √ If 24VAC is still on the terminal, then it is a stuck relay. √ If 24VAC disappears, then there is a need to check any of the wires hooked up to the W terminal. 	Automatically clears after fault signal is removed.
419	Critical	Equipment interface module and outdoor unit	The W output has reported more than five errors.	<ul style="list-style-type: none"> √ The system will shut down the outdoor unit. √ The W output (code E418) on the outdoor unit has reported more than five strikes. √ Disconnect thermostat wire from W and verify there is no 24VAC on the W. √ If 24VAC is present, replace the outdoor control. 	Automatically clears after power recycled.
420	Critical	Air handler or equipment interface module	The heat pump defrost cycle has taken more than 20 minutes to complete.	<ul style="list-style-type: none"> √ Defrost cycle lasts longer than 20 minutes. √ Check heat pump operation. √ This is applicable only in communicating indoor unit with non-communicating heat pump. 	Automatically clears when W1 signal is removed.
421	Critical	Equipment interface module and outdoor unit	The W output terminal on the outdoor unit is not wired correctly.	<ul style="list-style-type: none"> √ Voltage sensed on W output terminal when Y1 out is deactivated. 	Automatically clears once voltage is not sense on output for power cycled.
594	Moderate / Critical	Equipment interface module	Pre-coil discharge air temperature sensor problem (DFM mode only). Advances from moderate to critical after ten (10) minutes.	<ul style="list-style-type: none"> √ Interlock relay energized, but input not sensed after three seconds. √ No heating and cooling operations. √ De-energize interlock relay and re-energized five minutes later if demand is still present. 	Alarm clears five minutes after fault clears.