



2015 Lennox Industries Inc.
Dallas, Texas, USA



iComfort Wi-Fi®
Web and Mobile
Apps



iComfort Wi-Fi®
Thermostat

**THIS MANUAL MUST BE LEFT WITH THE HOMEOWNER
FOR FUTURE REFERENCE**

iComfort® Units

The iComfort Wi-Fi® thermostat works with the following indoor and outdoor units:

Indoor Units

G71MPP-03 or later
SLP98-01 or later
SL280-03 or later
EL296V-01 or later
CBX40UHV-02 or later
CBX32MV-06 or later

Outdoor Units

SL18XC-01 or later	XP20-01 or later
SL18XP-01 or later	XC21-05 or later
XC17-02 or later	XP21-01 or later
XP17-02 or later	XP21N-01 or later
XP17N-01 or later	XP25-01 or later
XP19-06 or later	XC25-01 or later
XC20-01 or later	

INSTALLER'S SYSTEM SETUP GUIDE

iComfort Wi-Fi® Thermostat

Touchscreen Programmable Communicating Thermostat

CONTROLS

507341-01
8/2015
Supersedes 5/2015



Shipping and Packing List

- 1 - iComfort Wi-Fi® thermostat (firmware version 2.13 changes included)
- 4 - Mounting screws
- 4 - Wall anchors
- 1 - Homeowner's manual
- 1 - Warranty card

NOTICE

Read this manual before programming this thermostat.

Use this thermostat only as described in this manual.

An extended version of this instruction is available on DaveNet. Instruction 507343-01 includes more detail information concerning default parameter settings, alert codes and additional information.

0815



507341-01

TABLE OF CONTENTS

iComfort Wi-Fi® Thermostat - Technical Description and Features . . .	2
Installation and Setup	3
Adjusting System Settings	4
Connecting to Home Wi-Fi Router	5
Troubleshooting Wi-Fi Connection	8
Account Registration	12
Firmware Update	12
Adding Non-Communicating Outdoor Unit and Accessories	12
<i>Outdoor Unit (Air Conditioner or Heat Pump)</i>	12
<i>Bypass (24VAC) Humidifier</i>	13
<i>Humiditrol® or Auxiliary Dehumidifier</i>	13
Adjusting Humidification and Dehumidification Settings with Communicating Outdoor Units	14
Adjusting Humidification and Dehumidification Settings with Non-Communicating Outdoor Units	15
Adjusting Zoning Control Settings	17
Using the Tests / Diagnostics Features	18
Wiring Diagrams	37
Configuring Air Handler Electric Heat	46
Using the Secure Web Portal	47
Screen-Saver	47
Accessing Installer Screens and Changing Equipment Parameters	47

WARNING

Improper installation, adjustment, alteration, service or maintenance can cause property damage, personal injury or loss of life.

Installation and service must be performed by a licensed professional HVAC installer (or equivalent) or service agency.

WARNING

This is a 24VAC Class 2 thermostat. Do not install on voltages higher than 30VAC.

Do not switch system to cool if the outdoor temperature is below 45°F (7°C). This can damage the cooling system.

iComfort Wi-Fi® Thermostat - Technical Description and Features

The 24VAC iComfort Wi-Fi® thermostat is an electronic communicating, color display touchscreen and 7-day programmable thermostat. It stores system parameters and settings in non-volatile memory (i.e., it retains data when electrical power fails or is turned off).

The iComfort Wi-Fi® thermostat can connect to online services via the Internet through the homeowner's Wi-Fi access point. After online registration is completed, the system may then be accessed by the homeowner from anywhere using a remote Internet connection via computer or personal communicating device.

Refer to page 37 for information on making connections to the thermostat.

This thermostat supports:

- Wireless bands 802.11b, 802.11g and 802.11n
- Three languages (English, French, Spanish)
- Air conditioning or heat pump units with up to four stages of heat / two stages of compressor operation (2 stages of heat pump heating, 2 stages of auxiliary back-up heating and 2 stages of emergency heating)
- Variable-capacity / multiple-stage heat / cool and universal compatibility (gas/electric/heat pump/air conditioner).
- Dual-fuel capable (iComfort®-enabled HP only) with two balance points.
- Indoor air quality with time-based notification of consumables including media filters, UVC bulbs, humidifier pads and PureAir™ system catalyst service / replacement,
- iHarmony® Zoning System (2 - 4 zones)
- Lennox iComfort® Equipment Interface Module (Catalog number 10T50) (provides iComfort Wi-Fi® to non-communicating indoor unit,
- Humidification measurement and control.
- Dew point adjustment control
- Humiditrol® Enhanced Dehumidification Accessory (EDA)
- Multiple-stage HVAC systems
- Equipment maintenance reminders
- Autochangeover mode -- Permits control of heating, cooling, humidification, and dehumidification without user involvement
- All Lennox branded communicating outdoor units contain a built-in outdoor temperature sensor.

Installation and Setup

During initial thermostat start-up the following screen will appear (see figure 1). This indicates that the thermostat is active and booting up.



Figure 1. Boot-Up Screen

COMMUNICATION ERROR SCREEN

During initial thermostat start-up if the following screen appears (see figure 2), this will indicate that the thermostat has been incorrectly wired or has shorted wires. Turn power off to the system and verify that all wiring is correct.



Figure 2. Communication Error Screen

Adjusting System Setting

SET TIME AND DATE

Use the arrows to select **Time and Date**; touch **edit** to proceed to the “Set current time and date” screen.

When “Time and Date” screen appears, enter the correct date as follows:

- Use the left and right arrows to change the month and year.
- Touch a day of the month to select it.
- Touch on the hour or minute; up down arrows appear to allow change.
- Touch the **am/pm** field to toggle it between am and pm.
- When the correct date and time is set, touch **save** to save settings and return to previous settings screen.

Touch **next** to continue to next screen.

CIRCULATE FAN ON TIME SETTING

“Circulate” is enabled on the user’s **home** screen or **system settings** page. It keeps air circulating from 15% to 50% percent of time. The following settings approximate how long the fan will run at these typical settings:

- 15% (9 minutes fan run time per hour)
- 25% (15 minutes fan run time per hour)
- 35% (21 minutes fan run time per hour)
- 45% (27 minutes fan run time per hour).

NOTE - If the circulate fan mode is on, a timer is set to measure all the time that the fan is blowing, regardless if it is running to deliver heating or cooling or just for air circulation.

DEALER NUMBER

Either the dealer number or phone number is required. Once either number is entered, all other fields will automatically be populated once the thermostat has been registered during the Wi-Fi setup procedure later on in this instruction (if the dealer has an account with Lennox already).

NOTE - Dealer number is the dealer’s Lennox account number. Dealer phone number is the dealer’s main office phone number.

1. Use the arrows to scroll down to the **Dealer Number** or **Dealer Phone** setting. Press **the edit** button.
2. Enter the **Dealer Number** or **Dealer Phone Number** using the on-screen keyboard. Press **save** to continue.

NOTE: If a Dealer Number or Dealer Phone Number is not entered and the next button is selected, a pop-up warning screen will appear.

3. Press **yes** to continue to the **System Devices** screen. Press **no** to return to the **system settings** screen.

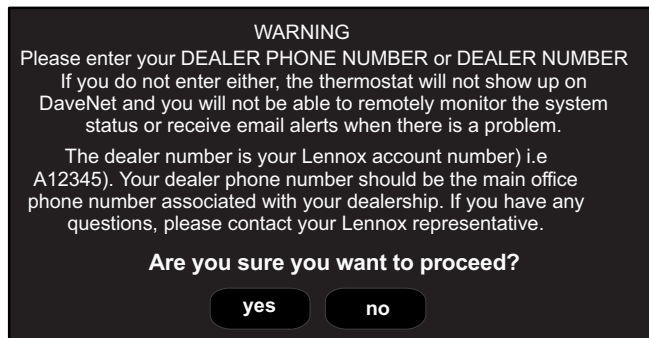

Figure 3. Dealer Number Warning

The following table lists all of the installer configurable system level parameters available from the installer setup screens. After adjusting system settings, select **next** to continue.

Table 1. System Settings

Parameter Name	Default	Parameter Value Setting	Increment
Time and Date	—	(Time/date elements screen)	—
Daylight Saving Time	Enabled	Enabled, Disabled	—
Circulate Fan ON Time	35%	Range 15 to 45%	1%
Temperature Unit	Fahrenheit	Fahrenheit or Celsius	—
System Name	—	(keyboard input screen)	—
Dealer Number	****	(keyboard input screen) Note: When adding the dealer number, all other dealer fields will auto populate once thermostat registration is completed.	—
Dealer Name	Lennox		—
Dealer Address	—		—
Dealer Phone	1-800-9-LENNOX		—
Dealer Email	—		—
Dealer Website	www.lennox.com		—

Connecting to a Home Wi-Fi Router

- NOTE - NEVER USE A HOME GUEST ACCOUNT.**
- NOTE - NEVER USE A OPEN ROUTER CONNECTION (NON-SECURE).**
- NOTE - ALWAYS USE A SECURE CONNECTION PHYSICALLY LOCATED IN THE HOME THAT THE THERMOSTAT IS BEING SETUP IN.**

Check the router utility program or contact service provider for help. When determining the location for the Wi-Fi thermostat, be sure it is in an area near enough to the home Wi-Fi router to ensure good communications signal strength between the thermostat and the Wi-Fi router. (**Hint:** Use a smart phone with Wi-Fi and Wi-Fi finder application to locate and determine optimal location based on router Wi-Fi signal strength.)

NOTE - Thermostat will not be able to reliably connect to a router if the received signal strength indicator (RSSI) is -70 or greater.

NOTE - Correct the cause of any alerts prior to continuing setup. Secure Connection Recommended! Verify the home Wi-Fi router supports at least one of the supports wireless bands (802.11b, g or n). Check router utility program or contact service provider for assistance.

ENABLING WI-FI

To enable the Wi-Fi feature to communicate with a wireless router

1. Press and release **Wi-Fi** in the lower left corner of the HOME screen

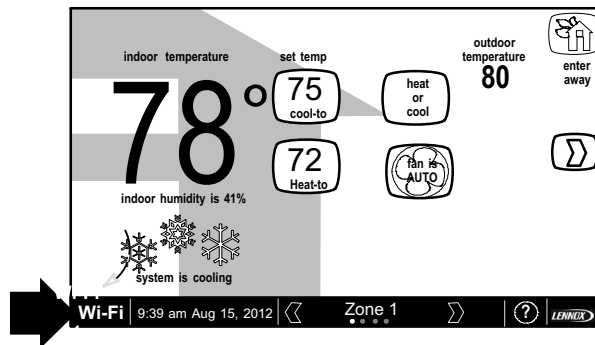

Figure 4. Press Wi-Fi

2. Press the **Wi-Fi disable** button to enable Wi-Fi.

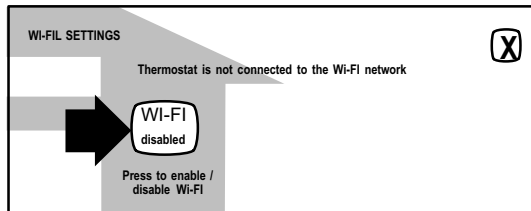

Figure 5. Enable Wi-Fi

3. The *User Agreement* screens will appear next. Press **next** as many times as necessary; then press **accept** after reading the User Agreement.

ESTABLISHING A WI-FI CONNECTIONS

There are two methods to setup your Wi-Fi connection. Select either *NETWORK SETTINGS* or *connection status*.

Method 1 — Network Settings Method

1. Press **NETWORK SETTINGS**; this screen shows a graphical view of buttons representing OPEN and SECURE Wi-Fi networks and a button for adding a network.

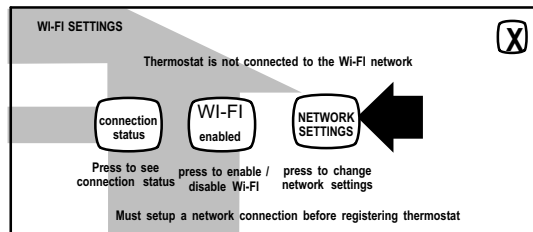

Figure 6. Enable Wi-Fi

- **Open** connection which which requires no password.
 - **Secure** connection which requires Wi-Fi password (security key).
 - **Add a network** is required when Wi-Fi identification (SSID) is being hidden (not broadcasting). You will need to know the Wi-Fi network name (SSID), security encryption type (if enabled), and security password (if security encryption is enabled).
2. When selecting a:
 - **unsecured** connection a screen will appear with two options, **connect** and **router info**. Press **connect** to continue.
 - **secured** connection a screen will appear requesting the Wi-Fi network password (security key). There are two options to select from which are **connect** and **router info**. Using the on-screen keyboard, enter the password (security key) and then press **connect** to continue.

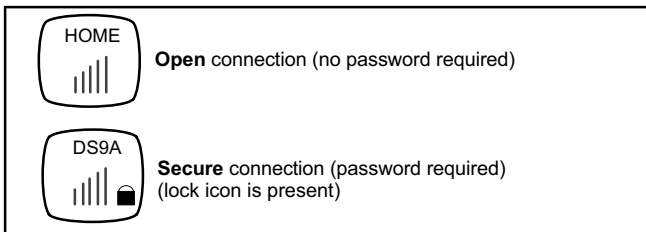

Figure 7. Typical Connection Type and Signal Strength

*NOTE - The **router info** button provides information concerning the home Wi-fi connection (i.e, RSSI, IP address, MAC address and wait state) all of which may be helpful in troubleshooting network connection issues).*

3. If connection is successful the screen will return to the available networks screens. Press **AP3** as exemplified in figure 8 to return to the previous screen. If the connection was successful it will be listed connected as exemplified below.

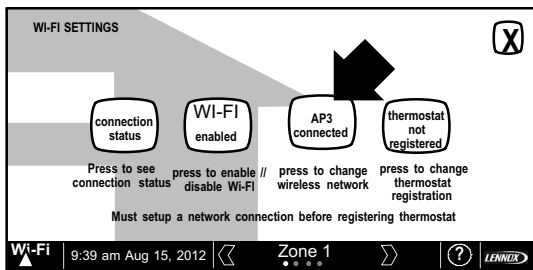

Figure 8. Network Connected

ESTABLISHING A WI-FI CONNECTIONS TO A HIDDEN NETWORK

1. When connecting to a hidden network, press the **add new network** icon to continue. Enter the **network name (SSID)**. If security encryption is enabled, then press the **security is none** icon. Select either **WEP, WPA** or **WPA2**.
2. Using the on-screen keyboard, enter the password (security key). If the network name or security key combination is incorrect or incorrectly type, and access to the specified network failed, a message will alert you to retry.
3. If connection is successful the screen will return to the available networks screens. The network successfully connected will be listed and shown as connected as exemplified in figure 8.

Method 2 — Connection Status Method

1. Press connection status; this screen shows a graphical view of the current connection status.

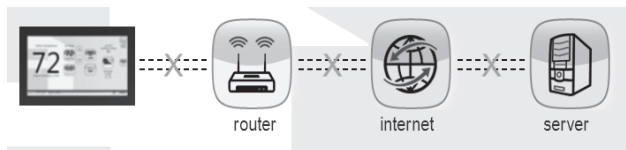

2. Select the router icon to choose the desire W-Fi network. When selecting a:
 - **unsecured** connection a screen will appear with two options, **connect** and **router info**. Press **connect** to continue.
 - **secured** connection a screen will appear requesting the Wi-Fi network password (security key). There are two options to select from which are **connect** and **router info**. Using the on-screen keyboard, enter the password (security key) and then press **connect** to continue.
3. If connection is successful the screen will return to the available networks screens. Press **X** to return to the previous screen. If the

connection was successful it will be listed connected as exemplified below.

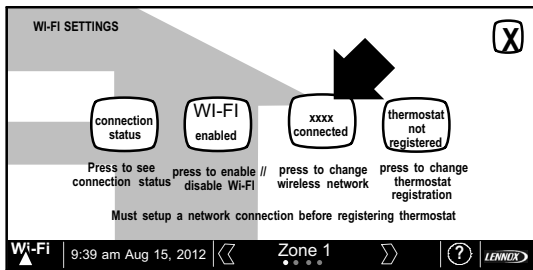
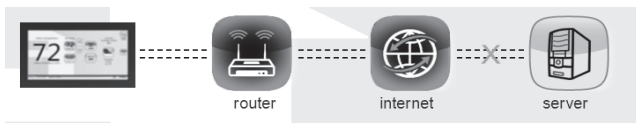

Figure 9. Network Connected

4. Select **X** to return to the **WI-FI SETTINGS** screen. Select connection status again to verify that connection to the *router* and *internet* is active. Both the *router* and *internet* icons will have green backgrounds if connections are successful.



5. Skip the next section if connection to the home Wi-Fi router, Internet and server were successful.

Troubleshooting Wi-Fi Connection

ROUTER / MODEM CHECK IF CONNECTION FAILS

1. Make sure the router and modem are turned on.
2. Check for connections to other wireless devices and internet connection.

3. Make sure the iComfort Wi-Fi® thermostat's Wi-Fi is enabled and connected to the home network (AP).
4. If having difficulty connecting to the router, online research the router model number and/or internet provider to discover and verify that the router band is set to B, G or N bands. You will need to access the routers utility program to make any changes. If not accessible please contact your service provider for help. The thermostat will connect to B, G or N band routers at this time. NOTE: When set to B or G bands, video streaming will likely be slower than N band. If homeowner has implemented a dedicated N band router for the purpose of video streaming, a separate router for the thermostat may be required.
5. Reboot your router
 - A Unplug your power cord, wait 30 seconds, then reconnect. If you have multiple routers, try rebooting all of them when problems occur.
 - B If there are multiple routers you must have different name and password for each one.
 - C On your computer, turning Wi-Fi off and then back on will force the system to rescan for available networks. Do you see the network your thermostat is trying to connect to?
6. Power cycle the thermostat.
7. Keep cordless phones, microwaves and other electrical equipment at least 3.5 feet (1m) away from access point.
 - A Try moving your router closer to the device if possible. If connection is improved, then there is probably some interference. Must have signal stronger than -70db (also, see Router Signal Strength on page 3); anything less will have signal losses or not connect at all.
 - B Adjust the direction of the router toward the thermostat. Adjust the routers antenna. A signal repeater may be needed.
8. Try changing channels on the access point and test it out with one of your internet devices (i.e. laptop, desktop). The IP address to the server from the stat will be close to the same IP address from the computer to the server (www.mycomfortsync.com).

COMPUTER CONNECTIONS:

- A On Access Point, Login to configuration (usually web based interface) > go to Wireless Settings and select a different channel > Save settings.
 - B Devices cannot change Wi-Fi channel. It is set only at the router.
 - C On the thermostat, disable, then re-enable the Wi-Fi connection.
9. Antenna in thermostat is fixed and cannot be moved. Location of your access point with respect to the thermostat is very important.
 10. Baby monitors, garage door openers and wireless video cameras may create signal interference.
 11. Check your encryption key (Password).
 12. Double check and re-enter your WEP/WPA encryption keys / pass-phrases (usually found on the router). If set to WEP security, change to WPA if allowed.
 13. In your thermostat's wireless settings, verify that your encryption key (password) is correct. There can not be spaces at the end of the SSID or Password.
 14. It is important to note that number of walls that the signal must pass thru to reach the thermostat can be an issue. (e.g. 4 indoor walls, or 1 outdoor wall + 2 indoor walls could mean a weak signal at the thermostat).
 15. The addition of a signal repeater or extender maybe an option. (Desktop or wall outlet plug-in devices are available online or at your local electronics stores in price range \$70 - \$150).
 16. If multiple routers are in the home make sure each router has a different name.
 17. If you don't get the pop up box that says the registration request has been forwarded, then the email was not sent to the server and the return registration link will not be sent to your email address. Try all the router troubleshooting procedures and if you still can't get it to send the email, cycle the power to the thermostat. This will cause the thermostat to ask for the Lennox server mac address again and try to resend the email.

18. If all is correct, refer user to their Router manufacturer and Network provider. Router may have incoming fire wall check with service provider.

ROUTER SIGNAL STRENGTH

After connecting to your router, you can check your signal strength by pushing the Wi-Fi icon on the home screen, then the networks button, then your network button, then the AP info button (see figure 10).

A strong wireless signal (RSSI) is indicated by a NEGATIVE decibel number in the range from -46 to -58db; anything greater than -80db will not connect.

If you are connected but have a signal above -70db then you may consider adding a signal repeater/extender or making some of the other router adjustment mentioned in the Router / Modem Check section

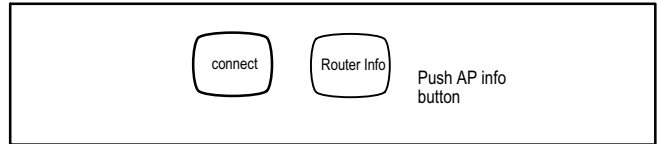

Figure 10. Access connection data

```
AT+NSTAT=?
MAC=00:ID:C9:A0:40:95
WSTATE=CONNECTED  MODE=AP
BSSID=98:FC:11:47:B9:00  SSID= LINKSYS" CHANNEL=6  SECURITY=NONE
RSSI=-78
IP ADDR=192.168.8.117  SUBNET=255.255.255.0  GATEWAY=192.168.8.1
DNS1=192.168.1.1  DNS2=0.0.0.0
RXCOUNT=14  TXCOUNT=345
OK
```

Figure 11. Connection data

Registering the iComfort Wi-Fi® Thermostat

REGISTRATION FOR ONLINE ACCESS

1. From the WI-FI SETTINGS screen, press either the **thermostat not registered** icon or the **connection status** icon and select the **server** icon.

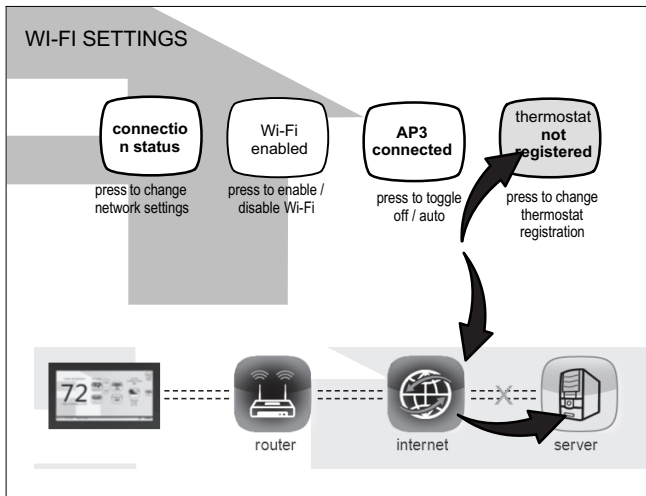

2. Enter homeowner email address and system description and press the **register** button.

Register with iComfort Wi-Fi thermostat to enable remote access and online weather information

enter your email

System Desc

3. A pop-up screen will appear asking if the email address below is correct? Verify the email address is correct and press **yes**.
4. Another pop-up screen will appear notifying the user to check their email.

An email has been sent to
xxxxxxxxxx@lennoxind.com
with instructions on how to register your thermostat. If you haven't received the email, please check your spam folder and make sure that your email address is correct.

NOTE - If the email address originally entered is incorrect, return to the **thermostat registered** screen and reenter the correct information and press **register**.

5. After the iComfort Wi-Fi® server sends the email with the network link, registration and account creation must be completed from the homeowner's personal computer.

NOTE - Time from pushing the registration button on the thermostat and receiving the consumer portal register link from your email on your computer is normally from 5 to 15 minutes depending on Internet speed and traffic.

6. After registration has been completed, press the connection status icon to verify the connection was successful. If the connection is successful the server icon background will be green.



7. After successful connection to the server is completed, the *firmware update* button will appear. The default setting is set to auto. If any firmware updates are available they will immediately start downloading and update the thermostat. The thermostat will reboot itself after the update is completed. Updates are done in the background and will not impair normal thermostat operations.

This auto update feature can be disabled by pressing the firmware update button to toggle to OFF but is not recommended.

NOTE - Firmware updates will not affect installer or user thermostat settings. Both will be retained after the update.

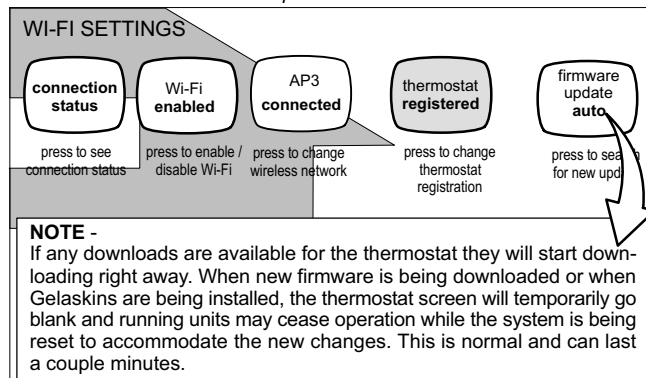

Figure 12. Registration for Online Access

User Account Registration for Lennox Server Access

icomfort Registration:
Create an Account

All fields are required

User Name

User name must have a minimum of 4 characters, must begin with a letter, and is not case sensitive.

Password

Password must have a minimum of 6 characters and must include at least one number.

Confirm Password

Yes, I agree to the [Terms and Conditions](#)

Figure 13. Registration Screen

NOTE - This following information is customer setup instructions and is shown here to allow the installer to help walk the customer through the setup process.

After registering through your iComfort Wi-Fi® thermostat interface, go to the homeowner's computer and locate the email sent from the server.

NOTE - if the customer has already setup an account, click the "Click Here" button to access that account.

Click on the Register link; the screen (to the left) will appear. Fill in the User Name and Password fields and check the agree to terms and conditions box. Click **Create User** button.

A series of pages and prompts follows to provide guidance through profile setup and user preference definitions.

Firmware Update

FIRMWARE UPDATE BUTTON

1. Firmware Update (Off) – No automatic firmware updates (highly recommend leaving ON)
2. If the status is changed from Off to Auto, it will trigger an immediate check and update for the firmware update. This can take up to 1 hour to complete depending on the user's internet speed, signal strength, internet traffic, etc.
3. Changing from Auto to Off during a download will NOT stop the current download if it is already in process.
4. Firmware Update (Auto) – (Default state). If enabled, the thermostat checks for firmware update a few minutes after commissioning and then every 24 hours in early morning hours.
5. Once a download is completed, the thermostat stops all activity for up to 3 seconds, restarts for 5 seconds, then continues with normal operation. All prior system and user settings are retained (Equipment, programs, Wi-Fi settings, etc.). Note a variation in indoor temperature may be observed after restart. This is normal operation of the thermostat while the temperature sensor algorithms adjust after a restart of the system.

Adding Non-Communicating Outdoor Unit and Accessories

OUTDOOR UNIT (AIR CONDITIONER OR HEAT PUMP)

To add (or remove) an outdoor unit that is not iComfort®-enabled, you must be at the "Add or Remove Non-communicating equipment?" screen.

1. Touch the **yes** button next to **Add or Remove Non-communicating equipment?**
2. In the "non-communicating device list" screen, use the arrows to highlight **Outdoor Unit Type** and touch **edit**.
3. Touch one of the radio buttons to select a 1-or 2-stage air conditioner unit or a 1-or 2-stage heat pump unit; touch **save**.
4. Use arrows to highlight any red colored text in the device list (e.g. select **Outdoor Unit Capacity**; text turns white). Touch **edit**.

5. Use either the up or down arrows to display the correct size outdoor unit. Touch **save** to continue.

*NOTE - If the defaults are correct, you do not have to make any changes, but you must touch **save**. When all red text is gone, the **back** button will appear; touch it to return to the "Add or Remove Non-communicating equipment?" screen.*

ADDING A HUMIDIFIER

Before adding a humidifier, be sure that the:

- Humidifier is wired to the furnace or air handler control as shown on the Optional Accessories wiring diagram (see page 42),
- Entire system is wired, powered up, and the thermostat has detected the system's installed communicating devices, and you are at the "Add or Remove Non-communicating equipment?" screen.

To add (or remove) a humidifier:

1. Touch the **yes** button on this screen.
2. In the "non-communicating device list" screen, use the arrows to highlight **Humidifier** (note the current value, **Not Installed**) and touch **edit**.
3. Touch one of the radio buttons to select the type of humidifier (or select **Not Installed**, if removing humidifier); touch **save**.
4. The previous screen returns, but the current value now shows your selection. Touch the **back** button.
5. The "Add or Remove..." screen reappears with your addition shown in the system devices list. At this point, you may add more equipment (touch **yes**) or if finished, touch the **next** button to advance to the "Adjust a setting..." screen (see page 15).

NOTE - Adding humidity regulating non-communicating devices may be a 2-step procedure:

- **First** the device must be installed and wired. After the humidifier is installed, the setting under the "System" mode "Humidification Control Mode" defaults to "Basic".

- **Second**, if you want another mode, i.e. Precision, Basic Dew Point, or Precision Dew Point, the device requires further configuration (see page 15).

ADDING HUMIDITROL® OR AN AUXILIARY DEHUMIDIFIER

Before adding a dehumidifier, be sure that:

- the dehumidifier is wired to the furnace or air handler control as shown on the Optional Accessories wiring diagram (see page 42),
- the entire system is wired, powered up, and the thermostat has detected the system's installed communicating devices, and you are at the "Add or Remove Non-communicating equipment?" screen.

To add (or remove) a dehumidifier, you must be at the "Add or Remove Non-communicating equipment?" screen.

1. Touch the **yes** button on this screen.
2. In the "non-communicating device list" screen, use the arrows to highlight **Dehumidifier** and touch **edit**. Note the current value (e.g. Not Installed).
3. Touch one of the radio buttons to select the type of dehumidifier (or select **Not Installed**, if removing dehumidifier); touch **save**.
4. When you scroll to the Dehumidifier device, (Note the current value, e.g. Humiditrol.) Click **back** to return to the "Add or Remove..." screen.
5. The "Add or Remove..." screen reappears with your addition shown in the system devices list. At this point, you may add more equipment (touch **yes**) or if finished, touch the **next** button to advance to the "Adjust a setting..." screen.

NOTE - Adding humidity regulating non-communicating devices may be a 2-step procedure:

- **First** the device must be installed and wired. After the dehumidifier is installed, the setting under the "System" mode "Dehumidification Control Mode" defaults to "Basic".
- **Second**, set Humiditrol® comfort adjust overcooling and the min/max dehumidification setpoints if desired (see page 16).

Adjusting Humidification and Dehumidification Settings with Communicating Outdoor Units

HUMIDIFICATION SETTINGS — FEATURE SCREEN

1. From the **Main Screen**, touch the **right arrow icon** to go the the **Features** screen.
2. From the **Features** screen, select **system** settings.
3. Touch the button of the humidification controls you want to adjust; if it says humidifier OFF, one touch will display a selection for ON.
4. When you touch the set-to button, the arrows appear, allowing you to change to the desired humidity percentage setting.

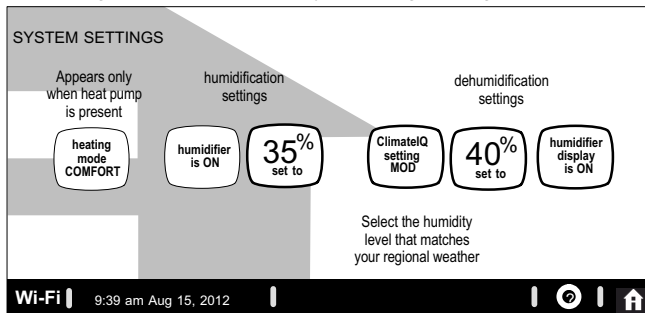

Figure 14. System Settings Screen (Example Only) - Communicating Outdoor Unit

DEHUMIDIFICATION SETTINGS — SYSTEM DEVICES SCREEN

Pre-adjustment REQUIREMENTS:

- **First**, the device has been **installed**
- **Second**, from the “Add or Remove Non-communicating equipment?”, touch **next**.
- **Third**, in the “Adjust a setting...” screen, configure the device as follows:

1. In the “system devices” list, use the arrows to highlight **System**. Touch **edit**.
2. **Humiditrol® only**—In the “System” list, use the arrows to highlight **Humiditrol Comfort Adjust**. The current value defaults to Maximum Overcooling. Touch **edit**.
3. **Humiditrol® only**—Touch one of the radio buttons to select the overcooling level; touch **save**. (*After saving, check that the current value now shows the new selection*).
4. Use arrows to highlight **Min Dehumidification Setpoint**; touch **edit**. Note the current value (e.g. 45).
5. Use arrows to make changes; touch **save**. (*After saving, check that the current value now shows the new selection*).
6. Touch the **back** button to return to “Adjust a setting...” screen.

DEHUMIDIFICATION SETTINGS — FEATURE SCREEN

1. From the **Main Screen**, touch the **right arrow icon** to go the the **Features** screen.
2. From the **Features** screen, select **system systems**.
3. Touch the **ClimateIQ** setting button. Available options when selected are selection for DRY, MODERATE and HUMID.
4. Selecting HUMID bring on the **set-to** button. When you touch the **set-to** button, the arrows appear, allowing you to change to the desired de-humidifier percentage setting.

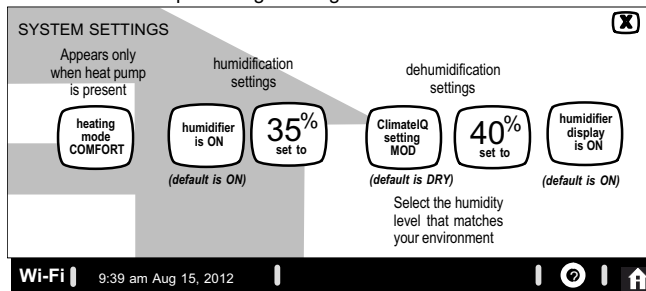

Figure 15. Humidifier Controls (Communicating Outdoor Unit)

HEATING MODE (XP25 ONLY) — CLIMATE IQ™

This technology optimizes dehumidification settings for specific climates to improve home comfort during cooling or heating operations.

Two climate settings are available:

- **Comfort** - The system adjust compressor operation to increase air temperature.
- **Normal** - Standard system operation.

COOLING MODE — CLIMATE IQ™

Three climate settings are available:

- **Dry** - The system supplies higher indoor airflow at all compressor capacities, increasing efficiency by operating at a higher sensible to total ratio.
- **Moderate** - The system supplies indoor airflow that balances efficiency and comfort.
- **Humid** - The system supplies lower indoor airflow at all compressor capacities, improving humidity removal by operating at a lower sensible to total ratio.

Adjusting Humidification and Dehumidification Settings with Non-Communicating Outdoor Units

HUMIDIFICATION SETTINGS — SYSTEM DEVICES SCREEN

Pre-adjustment REQUIREMENTS:

- **First** the device has been **installed**.
- **Second**, you pressed **next** at the “Add or Remove...” screen.

Configure the device as follows:

1. In the “system devices” list, use the arrows to highlight **System**. Touch **edit**.
2. In the “System” list, use the arrows to highlight **Humidification Control Mode**. Touch **edit**.

3. Touch one of the radio buttons to select the mode of humidification control; touch **save**. (*After saving, check that the current value now shows the new selection*).
4. Touch the **back** button to return to “Adjust a setting...” screen.

*NOTE - If the defaults for the settings are shown in red, you are not required to make any changes, but you must go into the edit tool, and touch **save**. When all red text is gone, the **back** button will appear; touch it to return to the “Adjust a setting...” screen.*

How Humidification Mode Works

DISPLAY, BASIC AND PRECISION—These modes allow user control of relative humidity between 15 and 45%. These conditions must be met for either mode to operate:

- humidification mode has been enabled, and
- the unit is in HEAT mode, and
- humidification demand exists (24V present at H), and
- **DISPLAY** mode indicates humidification is OFF.
- **BASIC** mode mode also requires presence of heating demand [Y for HP heat, or W for gas heat (W may be energized with G de-energized)].
- **PRECISION**—Outdoor temperature sensor is required.

Basic Dew Point Control adjustment mode will change the humidification setpoint based on the outdoor temperature and a user-defined dew point adjustment setting.

Precision Dew Point Control adjustment mode will operate when these conditions are met:

- humidification mode has been enabled, and
- the unit is in HEAT mode, and
- humidification demand exists (24V present at H).

HUMIDIFICATION SETTINGS — FEATURE SCREEN

1. From the **Main Screen**, touch the **right arrow** icon to go the the **Features** screen.
2. From the **Features** screen, select **system** settings.
3. Touch the button of the humidification settings you want to adjust; if it says humidifier OFF, one touch will display a selection for ON.
4. When you touch the **set-to** button, the arrows appear, allowing you to change to the desired humidity percentage setting.

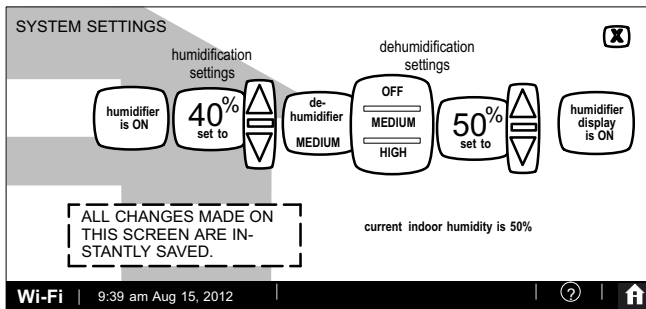

Figure 16. Humidification Controls (Non-Communicating Outdoor Unit)

DEHUMIDIFICATION SETTINGS — SYSTEM DEVICES SCREEN

Pre-adjustment REQUIREMENTS

- **First** the device has been **installed**
 - **Second**, from the “Add or Remove Non-communicating equipment?”, touch **next**.
 - **Third**, in the “Adjust a setting...” screen, configure the device as follows:
1. In the “system devices” list, use the arrows to highlight **System**. Touch **edit**.

2. **Humiditrol® only**—In the “System” list, use the arrows to highlight **Humiditrol Comfort Adjust**. The current value defaults to Maximum Overcooling. Touch **edit**.
3. **Humiditrol® only**—Touch one of the radio buttons to select the overcooling level; touch **save**. (After saving, check that the current value now shows the new selection).
4. Use arrows to highlight **Min Dehumidification Setpoint**; touch **edit**. Note the current value (e.g. 45).
5. Use arrows to make changes; touch (After saving, check that the current value now shows the new selection).
6. Touch the **back** button to return to “Adjust a setting...” screen.

DEHUMIDIFICATION SETTINGS — FEATURE SCREEN

1. From the **Main Screen**, touch the **right arrow** icon to go the the **Features** screen.
2. From the **Features** screen, select **system** settings.
3. Touch the button of the dehumidification settings you want to adjust; if it says de-humidifier OFF, one touch will display a selection for OFF, MEDIUM or HIGH.
4. Selecting MEDIUM or HIGH will bring on the **set-to** button.
5. When you touch the **set-to** button, the arrows appear, allowing you to change to the desired de-humidifier percentage setting.

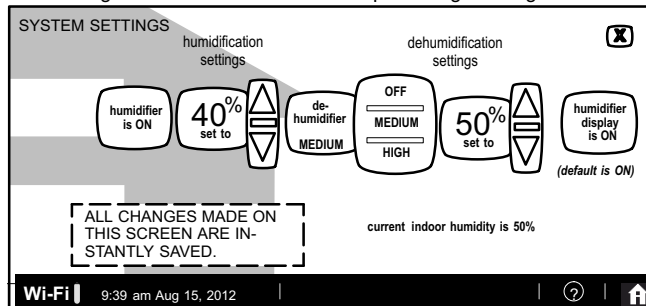

Figure 17. Humidifier Controls (Non-Communicating Outdoor Unit)

HOW DEHUMIDIFICATION MODE WORK — NO EXTERNAL DEHUMIDIFICATION DEVICE

NOTE - OFF, MEDIUM and HIGH dehumidification modes are also a function of the HVAC system with NO external dehumidification devices installed.

In **OFF** mode, dehumidification if off.

In **MEDIUM** mode, dehumidification occurs if these conditions are met and signals are present at specific terminals:

- dehumidification has been enabled on installer settings, and
- the unit is in COOL mode, and
- dehumidification demand exists (RH above setpoint), and
- cooling demand exists (Y1 energized).

In **HIGH** mode, dehumidification occurs if all BASIC conditions are true, except cooling demand may or may not be present. Also note that:

- **Maximum overcool from cooling setpoint is 2°F.**
- **Deadband** temperature is limited to a minimum of 5°F (instead of 3°F in **DRY** or **MODERATE** modes) because of 2°F overcooling.

AUXILIARY DEHUMIDIFIER — COMMUNICATING OR NON-COMMUNICATING OUTDOOR UNITS

Control State	Conditions
Auxiliary dehumidification is controlled by iComfort® thermostat with or without zoning.	<ul style="list-style-type: none"> • System must be in cooling mode and have a call for dehumidification from the iComfort® thermostat. This will start the auxiliary dehumidifier. • A separate wire from auxiliary dehumidifier will need to be run to G terminal on indoor unit control to start the blower.
Auxiliary dehumidification is controlled by dehumidification control with or without zoning	Needs a dehumidification demand from the stand-alone dehumidification thermostat and a separate wire run to G terminal on indoor unit to start the blower.

Zoning Control Settings

NOTE - Skip if no zoning control device is installed.

A. Heat/Cool Changeover

The following is an example of how the system operates during a heating / cooling changeover.

When the system is satisfying a call from zone 1 for heating and receives a call for cooling from zone 2, the following will occur:

- Then system will continue to fulfill the demand from zone 1 until satisfied, or a maximum time of 20 minutes has occurred.
- If after 20 minutes the system is still operating based on satisfying the heating demand from zone 1, the system will terminate that demand.
- The system will then shut system down for five (5) minutes. This will allow for system temperatures and operating pressures to stabilize.
- After a five 5 minute delay the system will begin operations to satisfied the cooling demand from zone 2.

The system will continue to operate in this matter each time it receives a zone call that is opposite of the current mode of operation (heating or cooling).

B. Damper Operation

Cooling Operation - Conventional Heat/Cool and Heat Pump Systems

When a in-zone thermostat makes a demand for cooling, the zone damper opens and the cooling equipment begins operating.

Cooling demand is terminated when:

1. All zone demands for cooling are terminated.
2. The demand has exceeded the heat/cool changeover time limit (20-minutes) while a heat demand exists.

When cooling demand is terminated, a 5 minute minimum off time delay is initiated.

Second stage cooling is energized when the discharge air temperature is 7°F higher than the setpoint of the cooling staging temperature jumper.

Heating Operation - Conventional Heat/Cool and Heat Pump Systems

When a in-zone thermostat makes a demand for heating, the zone damper opens and heating equipment begins operating. Heating demand is terminated when:

1. All zone demands for heating are terminated.
2. The demand has exceeded the heat/cool changeover time limit (20-minutes) while a cooling demand exists.

When heating demand is terminated, a 5-minute minimum off time delay is initiated.

Second-stage heating is energized if the discharge air temperature is lower than the setpoint of the heating staging temperature setpoint.

EDIT AND TEST AIRFLOW PER ZONE

Adjustment to all air flows can be made either at the System **Devices > System screen** or using the Edit and Test Airflow per Zone screen. The following procedure is to adjust individual zone airflow (CFM) for Blower Circulation, Cooling and Heating airflow.

- The **Maximum Airflow** for the selected mode on the left is displayed at the top right of the screen.
- The **Assigned Airflow** (the sum of the selected airflow for each zone) is displayed at the top right of the screen.

NOTE - The airflow per zone (in red) must be selected and verified before continuing.

1. Select the desired radio button option - **Blower Circulation Airflow, Cooling Airflow or Heating Airflow**
2. Adjust airflow for a specific zone by pressing on the desired zone. Total maximum airflow for all zones in this example is a combined 1250 CFM. Minimum CFM per zone is **50** and maximum is **1250**.
3. Adjust airflow by using the up or down arrow to change the CFM.
4. Touch **start** to begin operation for that specific zone.
5. Repeat procedure to configure all applicable zones.
6. Touch **save**.
7. Touch **next**.

Continue to next section on testing and diagnostics.

Using the Tests / Diagnostics Features

TO SELECT TESTS TO RUN

Use the following procedure to run test for various heating and cooling stage operations.

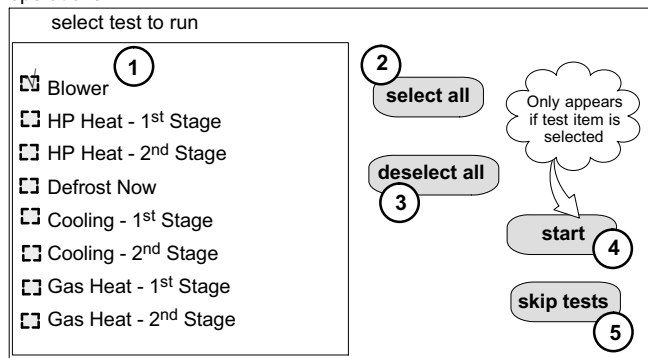

Figure 18. Selecting Tests

1. Select a specific tests (1) to run or use the **select all** (2) button to run all configurations. Use the **deselect all** (3) button to un-check desired test.
2. Touch the **start** button (4) to run all selected tests or touch **skip tests** (5) to end the test procedure.
3. After the tests are completed or you have selected skip test select the exit button to end.

NOTE - Test mode lasts for 30 minutes (with the temperature updating every 30 seconds) except for the defrost test, which lasts 30 seconds. Tests feature provides the technician time to manually verify the equipment operation.

The **tests** feature is available after **setup** has been completed once. After you touch **next** in the final **setup** screen, the “select tests to run” screen (figure 18) will appear. (If you want you may skip tests; touch **skip tests**.)

To run all of the tests, touch **select all**. All boxes in the list of tests will be checked. Or, touch box(es) next to test(s) to run certain tests.

After the tests have been started, the screen will describe which test is running and shows a diagnostic summary of each test (see figure 19). After reviewing the results and concluding that no further tests are needed, touch **next** to proceed to next test. The technician must verify that the test procedure is producing the desired result at the equipment.

After pressing **next** after the final test, the **Testing finished** screen will appear (figure 20). At this point, use the **EXIT** button (if you have completed the required setup), or use **diagnostics** button (to analyze the system), or use **equipment** button (if you wish to make any changes to device details).

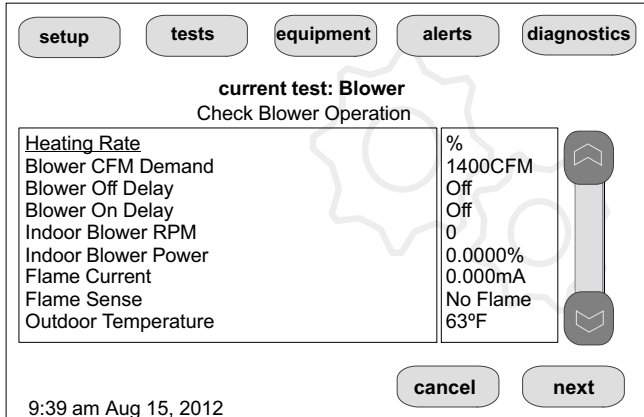

Figure 19. Typical Tests Results Screens



Figure 20. Testing Finished Screen

Touch **confirm** to continue system configuration; the screen will change to the system discovery screen. At this point, the program goes through the same setup as the initial setup process which begins on page 3.

NOTE - “Compatible device found” screen (shown below) appears only when a device has been removed and replaced with a compatible device.

Missing	Found Compatible
Device Equipment Type No.	Device Equipment Type No.
Model No. (control model no.)	Model No. (control model no.)
Serial No. (control serial no.)	Serial No. (control serial no.)

Settings were not copied

Table 1. Alert Codes and Troubleshooting

Critical alerts are displayed on Home (user) screen, in the Homeowner alert button, and in the Installer alert button. Minor and Moderate alerts are found only in the Installer alert button.

Alert Code	Priority	Alert Text	Steps to clear
10	Critical	(Thermostat) The thermostat has found an unknown device on the system.	An unknown device is seen on the sub-net in or outside of configuration mode. Clear by reconfiguring the system. Touch the setup tab, touch start, and touch confirm. If problem persists, then check all DEVICE connections to make sure they are iComfort®-compatible.
11	Critical	(Thermostat) The thermostat cannot find a previously installed unit.	Check all connections and cycle system power. If problem persists, clear by reconfiguring the system. Press the setup tab, touch start, and touch confirm. If problem persists, then check all DEVICE connections to make sure they are iComfort®-compatible.
12	Critical	(Thermostat) The thermostat cannot find an iComfort®-enabled indoor unit.	Thermostat did not find an Indoor Unit. Make sure there is an iComfort® indoor unit on the system. Check R, i+, i- and C connections, ohm wires and cycle power. Replace indoor unit control board if there is no response.
14	Critical	(Thermostat) The thermostat found more than one thermostat, more than one indoor unit, or more than one outdoor unit on the system.	Check wiring and remove duplicate equipment. Reconfigure system.
18	Minor	(Thermostat) The outside temperature is below the level where the heat pump is programmed to heat the home. The system will not use the heat pump to warm your home.	Notification only - Outdoor Temp is below the Low Balance Point. Heat Pump will not be used to service a heating demand.
19	Minor	(Thermostat) The outside temperature is higher than the level where the furnace or electric heat is programmed to work. The system will only use the heat pump to warm your home.	Notification only - Outdoor Temp is above the High Balance Point. Indoor Unit (furnace or air-handler) will not be used to service a heating demand.
29	Critical	(Thermostat) The thermostat is reading an indoor temperature that is higher than 99°F. The thermostat will not allow any heating operation to begin until it senses a temperature lower than 99°F.	Indoor temperature rose above 99°F during a heating or cooling demand. Heating operation is not allowed. Check to ensure that Heating Equipment is not stuck ON (reversing valve, etc.). Check the accuracy of the thermostat temperature sensor. Select cooling system mode to cool the indoor space.
30	Moderate	(Thermostat) The thermostat is reading an indoor temperature that is lower than 40°F. The thermostat will not allow any cooling operation to begin until it senses a temperature higher than 40°F.	Indoor Temp fell below 40°F. Cooling operation is not allowed. Check to ensure that cooling equipment is not stuck ON. Check accuracy of the thermostat temperature sensor. Select heating system mode to heat the indoor space to above 40°F.

Table 1. Alert Codes and Troubleshooting

Critical alerts are displayed on Home (user) screen, in the Homeowner alert button, and in the Installer alert button. Minor and Moderate alerts are found only in the Installer alert button.

Alert Code	Priority	Alert Text	Steps to clear
31	Critical	(Thermostat) The thermostat has lost communication with the (<i>furnace, air-handler or outdoor unit</i>) for more than 3 minutes.	[<i>Indicated unit</i>] has not communicated with thermostat for more than 3 minutes. Check connections. Ohm wires. If fault persists, then cycle power. Fault clears after communication is restored.
32	Moderate	(Thermostat) The (<i>furnace, air-handler or outdoor unit</i>) is resetting itself.	[<i>Indicated unit</i>] is resetting itself. This event may occur during a power outage or power fluctuation in the system. If persistent or if it coincides with the system operation then proceed with the following steps. Check the power connections, check the amp draw at the transformer (the transformer maybe overloaded) and check 24VAC voltage at the DEVICE. The alarm is only cleared by pressing the clear button on the Installer Alerts Tab. If the fault persists after checking the connections, replace the unit's control board.
34	Critical	(Thermostat) The thermostat does not know the capacity (tonnage) of the (<i>furnace, air-handler or outdoor unit</i>). Please program the correct capacity of the (<i>furnace, air-handler or outdoor unit</i>).	[<i>Indicated unit</i>] is missing the programmed unit capacity. Go to [<i>Indicated unit</i>] and program the unit capacity manually. See the unit IOM for programming instructions. Remove power to thermostat before programming the unit control board. Once programming is complete, reconnect thermostat wires and reconfigure system.
36	Critical	(Thermostat) The system has been heating for at least 15 minutes, without a demand for heating.	Run the system in diagnostic mode and verify that it matches actual equipment operation. Check for other alarms/codes that may be preventing the system from operating as expected. Step 1: Check all heating equipment to determine cause of heating demand. Step 2: Recycle power. System will clear code when it detects condition has cleared.
37	Critical	(Thermostat) The system has been cooling for at least 15 minutes, without a demand for cooling.	Run the system in diagnostic mode and verify that it matches actual equipment operation. Check for other alarms/codes that may be preventing the system from operating as expected. Step 1: Check all cooling equipment to determine cause of cooling demand. Step 2: Recycle power. System will clear code when it detects condition has cleared.
38	Critical	(Thermostat) The system has not been able to turn on the heating for more than 45 minutes. The system will go offline for 60 minutes and try again.	Run the system in diagnostic mode and verify that it matches actual equipment operation. Check for other alarms/codes that may be preventing the system from operating as expected. Step 1: Check all heating equipment to determine cause. Step 2: Recycle power. System will clear code when it detects condition has cleared.

Table 1. Alert Codes and Troubleshooting

Critical alerts are displayed on Home (user) screen, in the Homeowner alert button, and in the Installer alert button. Minor and Moderate alerts are found only in the Installer alert button.

Alert Code	Priority	Alert Text	Steps to clear
39	Critical	(Thermostat) The system has not been able to turn on the cooling for more than 45 minutes. The system will go offline for 60 minutes and try again.	Run the system in diagnostic mode and verify that it matches actual equipment operation. Check for other alarms/codes that may be preventing the system from operating as expected. Step 1: Check all cooling equipment to determine cause. Step 2: Recycle power. System will clear code when it detects condition has cleared.
105	Critical	(Thermostat / Furnace / Air Handler / Outdoor Unit/ Equipment Interface Module / Damper Control Module) The (<i>Thermostat, furnace, air-handler or outdoor unit</i>) has lost communication with the rest of the system.	Equipment is unable to communicate. This may indicate the existence of other alarms/codes. In most cases errors are related to electrical noise. Make sure high voltage power is separated from RSBus. Check for incorrectly wired and/or loose connections between the Thermostat, indoor unit and outdoor unit. Check for a high voltage source of noise close to the system. Generally, this is a self-recoverable error.
110	Critical	(Furnace) The line voltage is too low.	This alarm/code may appear during a brownout. Line voltage is below its designed operating value. Check and correct the power line voltage.
111	Critical	(Furnace) The line power voltage wiring is reversed.	The unit is reporting that its power line and neutral are reversed. Turn off the power to the system and correct the line power voltage wiring. System resumes normal operation 5 seconds after fault recovered.
112	Critical	(Furnace) The reporting device cannot find earth ground. The thermostat will shut down the system.	Provide proper earth ground to the equipment. System resumes normal operation 5 seconds after fault recovered.
113	Critical	(Furnace) The line voltage is too high.	Line voltage high (voltage higher than nameplate rating). Provide power voltage within proper range. System resumes normal operation 5 seconds after fault recovered.
114	Critical	(Furnace / Air Handler / Equipment Interface Module / Damper Control Module)) There is a frequency/distortion problem with the power to the (<i>furnace or air-handler</i>).	This alarm/code may indicate transformer overloading. Check the voltage and line power frequency. Check the generator operating frequency, if the system is running on back-up power. Correct voltage and frequency problems. System resumes normal operation 5 seconds after fault recovered.
115	Critical	(Furnace / Air Handler) The 24VAC to the (<i>furnace or air-handler control board</i>) is lower than the required range of 18 to 30VAC.	24-Volt Power Low (Range is 18 to 30 volts). Check and correct voltage. Check for additional power-robbing equipment connected to system. This alarm/code may require the installation of an additional or larger VA transformer.
115	Critical	(Damper Control Module) The secondary 24VAC damper control module is low.	24-Volt Power Low (Range is 18 to 30 volts). Check and correct voltage. Check for additional power-robbing equipment connected to system. This alarm/code may require the installation of an additional or larger VA transformer.

Table 1. Alert Codes and Troubleshooting

Critical alerts are displayed on Home (user) screen, in the Homeowner alert button, and in the Installer alert button. Minor and Moderate alerts are found only in the Installer alert button.

Alert Code	Priority	Alert Text	Steps to clear
117	Minor	(Furnace) The reporting unit has poor earth grounding.	Provide proper grounding for the unit. Check for proper earth ground to the system. The alarm/code will clear 30 seconds after it is corrected.
120	Moderate	(Thermostat / Furnace / Air Handler / Outdoor Unit / Equipment Interface Module) There is a delay in the (<i>Thermostat, furnace, air-handler or outdoor unit</i>) responding to the system.	Typically, this alarm/code does not cause any issues and will clear on its own. The alarm/code is usually caused by a delay in the outdoor unit responding to the thermostat. Check all wiring connections. Cleared after unresponsive device responds to any inquiry.
124	Critical	(Thermostat / Furnace / Air Handler / Outdoor Unit / Equipment Interface Module / Damper Control Module) The thermostat has lost communication with the (<i>furnace, air-handler or outdoor unit</i>) for more than 3 minutes.	Equipment lost communication with the thermostat. Check the wiring connections, ohm wires and cycle power. The alarm stops all associated HVAC operations and waits for a heartbeat message from the unit that's not communicating. The alarm/fault clears after communication is re-established.
125	Critical	(Thermostat / Furnace / Outdoor Unit / Damper Control Module) There is a hardware problem on either the (<i>Thermostat, furnace control board, air-handler control board or outdoor unit control board</i>).	There is a control hardware problem. Replace the control if the problem prevents operation and is persistent. The alarm/fault is cleared 300 seconds after the fault recovers.
126	Critical	(Furnace / Outdoor Unit) There is an internal communication problem with the (<i>furnace control board, air-handler control board or outdoor unit control board</i>).	There is an internal hardware problem on the control. Typically the control will re-set itself. Replace the control if the problem prevents operation and is persistent. The alarm/fault is cleared 300 seconds after the fault recovers.
130	Moderate	(Air Handler / Equipment Interface Module) An air-handler configuration jumper is missing.	Configuration jumper(s) missing on control (applicable in non-communicating applications only). Replace the jumper or put wire between terminals on control. Cleared after jumper is connected.
131	Critical	(Thermostat / Furnace / Air Handler / Outdoor Unit / Equipment Interface Module / Damper Control Module) The (<i>Thermostat, furnace, air-handler or outdoor unit</i>) control parameters are corrupted.	Reconfigure the system. Replace the control if heating or cooling is not available.
132	Critical	(Air Handler / Damper Control Module) The device's control software is corrupted.	Recycle power. If failure re-occurs, replace the control. System reset is required to recover.

Table 1. Alert Codes and Troubleshooting

Critical alerts are displayed on Home (user) screen, in the Homeowner alert button, and in the Installer alert button. Minor and Moderate alerts are found only in the Installer alert button.

Alert Code	Priority	Alert Text	Steps to clear
180	Critical	(Furnace / Air Handler / Outdoor Unit/ Equipment Interface Module) The thermostat has found a problem with the (<i>furnace, air-handler or outdoor unit</i>) outdoor sensor.	In normal operation after control recognizes sensors, the alarm will be sent if valid temperature reading is lost. Compare outdoor sensor resistance to temperature/resistance charts in unit installation instructions. Replace sensor pack if necessary. At the beginning of (any) configuration, furnace or air-handler control will detect the presence of the sensor(s). If detected (reading in range), appropriate feature will be set as 'installed' and shown in the 'About' screen. The alarm/fault will clear upon configuration, or sensing normal values.
200	Critical	(Furnace) The furnace roll out limit switch is open.	Correct the cause of roll out trip. Reset roll out switch. Reset power to clear. Test the furnace operation. The alarm/fault clears after the furnace roll out switch is closed.
201	Critical	(Furnace / Air Handler) The system has lost communication with the (<i>furnace or air-handler</i>) indoor blower motor.	Lost communication with indoor blower motor. Possible causes include: power outage, brown-out, motor not powered, loose wiring, condensation on air handler control without cover on breaker. Problem may be on control or motor side. Cleared after communication is restored.
202	Critical	(Furnace / Air Handler) The unit size code for the (<i>furnace or air-handler</i>) and the size of blower motor do not match.	Incorrect appliance unit size code selected. Check for proper configuring under Unit Size Codes for Furnace/Air Handler on configuration guide or in installation instructions. The alarm/fault clears after the correct match is detected following a reset. Remove the thermostat from the system while applying power and reprogramming.
203	Critical	(Furnace / Air Handler) The unit size code for the (<i>furnace or air-handler</i>) has not been selected.	No appliance unit size code selected. Check for proper configuring under: Unit Size Codes for Furnace/Air Handler on configuration guide or in installation instructions. Critical Alert. The alarm/fault clears after the correct match is detected following a reset. Remove the thermostat from the system while applying power and reprogramming.
204	Critical	(Furnace) There is a problem with the furnace gas valve.	Check gas valve operation and wiring. The alarm/fault clears after the issue is corrected.
205	Critical	(Furnace) The furnace gas valve relay contact is closed.	Check wiring on control and gas valve. The alarm/fault clears after the issue is corrected.
206	Critical	(Furnace) The furnace gas valve 2nd stage relay is faulty.	Furnace will operate on 1st stage for the remainder of the heating demand. The alarm/fault will clear after the issue is corrected. If unable to operate 2nd stage, replace control.
207	Critical	(Furnace) The furnace hot surface igniter is open.	Measure the resistance of hot surface igniter. Replace the it if it is not within the specified range found in IOM. The alarm/fault clears after the issue is corrected.
223	Critical	(Furnace) The furnace low pressure switch is open.	Check pressure (inches w.c.) of low pressure switch closing during a heat call. Measure operating pressure (inches w.c.). Inspect vent and combustion air inducer for correct operation and restriction. The alarm/fault clears after the issue is corrected.

Table 1. Alert Codes and Troubleshooting

Critical alerts are displayed on Home (user) screen, in the Homeowner alert button, and in the Installer alert button. Minor and Moderate alerts are found only in the Installer alert button.

Alert Code	Priority	Alert Text	Steps to clear
224	Critical	(Furnace) The furnace low pressure switch is stuck closed.	Check operation of low pressure switch to see if it is stuck closed for longer than 150 seconds during a heat call . Measure operating pressure (inches w.c.). Inspect vent and combustion air inducer for correct operation and restriction. The alarm/fault clears after the issue is corrected.
225	Critical	(Furnace) The furnace high pressure switch is failing to close.	Check pressure (inches w.c.) of high pressure switch closing during a heat call. Measure operating pressure (inches w.c.). Inspect vent and combustion air inducer for correct operation and restriction. The alarm/fault clears after the issue is corrected.
226	Critical	(Furnace) The furnace high pressure switch is stuck closed.	Check operation of high pressure switch closing during a heat call. Measure operating pressure (inches w.c.). Inspect vent and combustion air inducer for correct operation and restriction. The alarm/fault clears after the issue is corrected.
227	Moderate	(Furnace) The furnace low pressure switch is open in run mode.	Check pressure (inches w.c.) of low pressure switch closing during a heat call. Measure operating pressure (inches w.c.). Inspect vent and combustion air inducer for correct operation and restriction. The alarm/fault clears after the issue is corrected.
228	Moderate	(Furnace) The furnace control is not able to calibrate the pressure switch.	Unable to perform pressure switch calibration. Check vent system and pressure switch wiring connections. Check the drain trap for blockage. The alarm/fault clears after a successful calibration.
229	Minor	(Furnace) The furnace control has switched to high fire ignition because the low fire pressure switch did not close in the allowed time.	IFC switched to high fire ignition because low fire pressure switch did not close in allowed time. No action is needed.
240	Moderate	(Furnace) The furnace flame current is low.	Check micro-amperes of the flame sensor using thermostat diagnostics. Clean or replace the flame sensor. Measure voltage of neutral to ground to ensure good unit ground. The alarm clears after a proper micro-amp reading has been sensed.
241	Critical	(Furnace) The furnace flame is going out while the furnace is heating.	Shut off gas. Check for a gas valve leak. Replace the gas valve if needed. The alarm/fault will clear when a heat call ends successfully.
250	Moderate	(Furnace) The furnace primary limit switch is open.	Check for proper firing rate on furnace. Ensure there is no blockage in the furnace and the duct work. Check for proper air flow. If limit switch is not closed within 3 minutes, the unit will go into 1-hour Watchguard mode. The alarm/fault will clear when a heat call ends successfully.
252	Moderate	(Furnace) The furnace discharge air-temperature is high.	Check temperature rise, air flow and input rate. Check for dirty filters. The alarm/fault will clear when a heat call ends successfully.
270	Critical	(Furnace) The furnace is in Watchguard mode. The furnace igniter cannot turn on the flame.	This is a five strike condition during a single demand. Check for proper gas flow. Ensure that igniter is lighting burner. Check flame sensor current. Check for dirty filters. The alarm/fault will clear on successful ignition.

Table 1. Alert Codes and Troubleshooting

Critical alerts are displayed on Home (user) screen, in the Homeowner alert button, and in the Installer alert button. Minor and Moderate alerts are found only in the Installer alert button.

Alert Code	Priority	Alert Text	Steps to clear
271	Critical	(Furnace) The furnace is in Watchguard mode. The furnace low pressure switch is open.	This is a five strike condition during a single demand. Check pressure (inches w.c.) of low pressure switch closing during a heat call. Measure operating pressure (inches w.c.). Inspect vent and combustion air inducer for correct operation and restriction. The alarm/fault will clear on successful ignition.
272	Critical	(Furnace) The furnace is in Watchguard mode. The furnace low pressure switch is open during run mode.	Check operation of low pressure switch to see if it is stuck open during a heat call. Measure operating pressure (inches w.c.). Inspect vent and combustion air inducer for correct operation and restriction. The alarm/fault will clear when a heat call ends successfully.
273	Critical	(Furnace) The furnace flame is going off during a heating cycle.	Check micro-amperes of flame sensor using thermostat diagnostics. Clean or replace sensor. Measure voltage of neutral to ground to ensure good unit ground. The alarm/fault will clear when a heat call ends successfully.
274	Critical	(Furnace) The furnace limit switch has been open for more than 3 minutes.	The system will go into Watchguard mode. Check firing rate and air flow. Check for blockage. The alarm/fault will clear when a heat call ends successfully.
275	Critical	(Furnace) The furnace flame is out of sequence.	The system will go into Watchguard mode. Shut off gas. Check for gas valve leak. The alarm/fault will clear on next successful ignition.
276	Critical	(Furnace) The furnace is not able to calibrate or the high pressure switch opened or failed to close in run mode.	The system will go into Watchguard mode. Check vent system and pressure switch wiring connections. The fault/alarm will clear when the furnace calibrates itself successfully.
290	Critical	(Furnace) There is a problem with the furnace ignition circuit.	The system will go into Watchguard mode. Measure resistance of hot surface igniter. Replace the hot surface igniter if it is not within specifications. The alarm/fault will clear on next successful ignition.
291	Critical	(Furnace) The heating airflow is below the minimum required level.	The system will go into Watchguard mode. Check for dirty filters and other air flow restrictions. Check blower performance. The alarm/fault will clear when a heat call ends successfully.
292	Critical	(Furnace / Air Handler) The (<i>furnace or air-handler</i>) indoor blower motor will not start.	The system will go into Watchguard mode. Indoor blower motor unable to start. This could be due to seized bearing, stuck wheel, obstruction etc. Replace motor or wheel if assembly does not operate or meet performance standards. The alarm/fault clears after the indoor blower motor starts successfully.
294	Critical	(Furnace) There is over current in the furnace inducer motor.	The system will go into Watchguard mode. Check combustion blower bearings, wiring and amps. Replace if does not operate or does not meet performance standards. The alarm/fault clears after inducer current is sensed to be in-range after the ignition following the Watchguard mode or reset.
295	Minor	(Furnace) The indoor blower motor is over heating.	Indoor blower motor over temperature (motor tripped on internal protector). Check motor bearings and amps. Replace if necessary. The alarm/fault clears after blower demand is satisfied.

Table 1. Alert Codes and Troubleshooting

Critical alerts are displayed on Home (user) screen, in the Homeowner alert button, and in the Installer alert button. Minor and Moderate alerts are found only in the Installer alert button.

Alert Code	Priority	Alert Text	Steps to clear
310	Critical	(Furnace / Air Handler / Damper Control Module) There is a problem with (<i>furnace or air-handler</i>) discharge air sensor.	Compare outdoor sensor resistance to temperature/resistance charts in installation instructions. Replace sensor if necessary. The alarm/fault is cleared 30 seconds after fault is detected as recovered.
311	Minor	(Furnace) The heat firing rate has been reduced to match available airflow (cutback mode).	Warning Only. Furnace blower in cutback mode due to restricted airflow. Reduce firing rate every 60 seconds to match available CFM. Check filter and duct system. To clear, replace filter if needed or repair/add duct. 2-stage controls will reduce firing rate to 1st stage. The alarm/fault clears when a heat call finishes successfully.
312	Minor	(Furnace / Air Handler) The blower cannot provide the requested CFM due to high static.	Warning Only. Restricted airflow - Indoor blower is running at a reduced CFM (Cutback Mode - The variable speed motor has pre-set speed and torque limiters to protect the motor from damage caused by operating outside of design parameters (0 to 0.8" e.g. total external static pressure). Check filter and duct system. To clear, replace filter if needed or repair/add duct. The alarm/fault is cleared after the current service demand is satisfied.
313	Minor	(Furnace / Air Handler) The indoor and outdoor unit capacities do not match.	Check for proper configuring in installation instructions. Alarm is just a warning. The system will operate, but might not meet efficiency and capacity parameters. The alarm will clear after commissioning is complete.
344	Critical	(Furnace) Relay Y1 Failure	Y1 relay failed; operation stopped. Alarm clears 300 seconds after Y1 input sensed OFF.
345	Critical	(Air Handler / Equipment Interface Module / Heat Pump) The "O" relay on the air-handler has failed. Either the pilot relay contacts did not close or the relay coil did not energize.	O relay / Stage 1 failed. Pilot relay contacts did not close or the relay coil did not energize. Replace control. Cleared after the fault recovered following reset.
346	Critical	(Air Handler) The heat pump jumper was not removed on the air-handler control board.	Configuration link(s) not removed on control. Cut O-R. Applicable with non communicating outdoor unit with communicating indoor system.
347	Critical	(Furnace / Air Handler / Equipment Interface Module) The "Y1" relay on the (<i>furnace or air-handler</i>) has failed. Either the pilot relay contacts did not close or the relay coil did not energize.	Operation stopped. Y1 relay / Stage 1 failed. (Pilot relay contacts did not close or the relay coil did not energize; no input back to IFC chip). Critical Alert. Cleared after reset and Y1 input sensed.
348	Critical	(Furnace / Air Handler) The "Y2" relay on the (<i>furnace or air-handler</i>) has failed. Either the pilot relay contacts did not close or the relay coil did not energize.	Y2 relay / Stage 2 failed. (Pilot relay contacts did not close or the relay coil did not energize; no input back to IFC chip). Critical Alert. Cleared after reset and Y1 input sensed.
349	Critical	(Furnace) The "O" to "R" jumper on the furnace needs to be restored.	Configuration link R to O needs to be restored. Replace link or hard-wire. Applicable in non communicating mode. Critical Alert.

Table 1. Alert Codes and Troubleshooting

Critical alerts are displayed on Home (user) screen, in the Homeowner alert button, and in the Installer alert button. Minor and Moderate alerts are found only in the Installer alert button.

Alert Code	Priority	Alert Text	Steps to clear
350	Critical	(Air Handler) The air-handler's electric heat is not configured.	Heat call with no configured or incorrectly configured electric heat. Check for proper configuring under Configuring Electric Heat Stages in the air handler installation instructions. Cleared after electrical heat detection is successful.
351	Critical	(Air Handler) There is a problem with the air-handler's 1st stage electric heat. Either the pilot relay contacts did not close, or the relay coil in the electric heat section did not energize.	Heat section / Stage 1 failed. (Pilot relay contacts did not close, or the relay coil in the electric heat section did not energize.) Air handler will operate on 1st stage for remainder of the heat call. Will clear after fault recovered.
352	Critical	(Air Handler) There is a problem with the air-handler's 2nd stage electric heat. Either the pilot relay contacts did not close, or the relay coil in the electric heat section did not energize. The air-handler will operate on 1st stage electric heat until the issue is resolved.	Heat section / Stage 2 failed (Same as Code 351).
353	Critical	(Air Handler) There is a problem with the air-handler's 3rd stage electric heat. Either the pilot relay contacts did not close, or the relay coil in the electric heat section did not energize. The air-handler will operate on 1st stage electric heat until the issue is resolved.	Heat section / Stage 3 failed (Same as Code 351).
354	Critical	(Air Handler) There is a problem with the air-handler's 4th stage electric heat. Either the pilot relay contacts did not close, or the relay coil in the electric heat section did not energize. The air-handler will operate on 1st stage electric heat until the issue is resolved.	Heat section / Stage 4 failed (Same as Code 351).
355	Critical	(Air Handler) There is a problem with the air-handler's 5th stage electric heat. Either the pilot relay contacts did not close, or the relay coil in the electric heat section did not energize. The air-handler will operate on 1st stage electric heat until the issue is resolved.	Heat section / Stage 5 failed (Same as Code 351).

Table 1. Alert Codes and Troubleshooting

Critical alerts are displayed on Home (user) screen, in the Homeowner alert button, and in the Installer alert button. Minor and Moderate alerts are found only in the Installer alert button.

Alert Code	Priority	Alert Text	Steps to clear
370	Critical	(Furnace) The furnace control board has not received 24VAC power for 2 minutes or more.	Control sees the loss of 24VAC for 2 minutes .Terminate all services and wait for interlock switch to close. The alarm will clear when 24VAC is continuously sensed on DS terminal for a minimum of 10 seconds or on a power reset. If 2 stage with float switch, the IFC control R-DS is open.
380	Moderate / Critical	(Equipment Interface Module) Interlock relay failure (IFC or AHC mode only)	Interlock relay is energized, but input is not sensed after 3 seconds. There will be no heating or cooling due to this error. De-energize interlock relay and energize after 5 minutes if demand is still present.
381	Moderate / Critical	(Equipment Interface Module) Interlock relay stuck (IFC or AHC modes only)	Interlock relay continuously sensed (with relay off). No heating and cooling operations. Alarm clears 30 seconds after fault clears.
382	Moderate	(Equipment Interface Module) Relay W1 failure (IFC and AHC modes only)	W1 relay energized, but input is not sensed after three seconds.
400	Critical	(Outdoor Unit) The compressor internal overload has tripped.	Thermostat demand Y1 is present; but, compressor is not running. Check power to unit. Clears the error after current is sensed in both RUN and START sensors for at least 2 seconds, or after service is removed, or after power reset.
401	Moderate	(Outdoor Unit) Either the compressor ran for more than 18 hours continuously trying to cool the home or the refrigerant pressure in the system is low.	Compressor ran more than 18 hours to satisfy a single thermostat demand. Will not lock-out system. If 2 stage, units with blinking LED light controls, unit will run in low speed; units with 7-segment display will display code, but continue to run in high speed. If a Heat Pump, and if outdoor temp is less than 65 degrees, code is ignored. Clears the error after 30 consecutive normal run cycles or power reset. Also monitors low pressure switch trips.
402	Critical	(Outdoor Unit) Either the discharge or suction pressure level is out-of-limits, or the is compressor overloaded.	Discharge or suction pressure out-of-limits, or compressor overloaded. Clears the error after 4 consecutive normal compressor run cycles.
403	Moderate	(Outdoor Unit) The compressor ran for less than 3 minutes to satisfy a thermostat demand.	Compressor runs less than 3 minutes to satisfy a thermostat demand. Clears the error after 4 consecutive normal run cycles or power reset.
404	Critical	(Outdoor Unit) The compressor rotor is locked up. This could be due to a short circuiting of the run capacitor, seizing of the bearings or excessive liquid refrigerant etc.	Compressor rotor locked up due to run capacitor short, bearings are seized, excessive liquid refrigerant, etc. (NOTE: May need to install hard start kit). Clears the error after 4 consecutive normal run cycles or after power reset.
405	Critical	(Outdoor Unit) The compressor circuit is open. This could be due to a power disconnection, open fuse etc.	Compressor circuit open (due to power disconnection, open fuse, etc.) Clears the error after 1 normal compressor run cycle.

Table 1. Alert Codes and Troubleshooting

Critical alerts are displayed on Home (user) screen, in the Homeowner alert button, and in the Installer alert button. Minor and Moderate alerts are found only in the Installer alert button.

Alert Code	Priority	Alert Text	Steps to clear
406	Critical	(Outdoor Unit) The required amount of current is not passing through the start current transformer.	Required amount of current is not passing through Start current transformer. Clears the error after current is sensed in START sensor, or after power reset.
407	Critical	(Outdoor Unit) The required amount of current is not passing through run current transformer.	Required amount of current is not passing through the RUN current transformer. Clears the error after current is sensed in the RUN sensor, or 1 normal compressor run cycle, or after power reset
408	Critical	(Outdoor Unit) The compressor is running continuously.	Compressor runs continuously. Clears the error after 1 normal compressor run cycle or after power reset.
409	Moderate	(Furnace / Air Handler / Outdoor Unit) The secondary voltage for the (<i>furnace, air-handler or outdoor unit</i>) has fallen below 18VAC. If this continues for 10 minutes, the thermostat will turn off the (<i>furnace, air-handler or outdoor unit</i>).	Secondary voltage is below 18VAC. After 10 minutes, operation is discontinued. Clears the code after voltage is higher than 20VAC for two seconds or after power reset.
410	Moderate	(Outdoor Unit) The outdoor unit pressure is below the required limit.	Low pressure switch opens at a specific pressure (system shuts down) and closes at a specific pressure (system restarts). For specific unit low pressure values, see the applicable unit documentation.
411	Critical	(Outdoor Unit) The low pressure switch has opened 5 times during a single demand. As a result, the thermostat has shutdown the outdoor unit.	Open low pressure switch error count reached five strikes. Check system charge using approach and sub cooling temperatures. Reset by putting outdoor unit control in test mode or resetting low voltage power.
412	Moderate	(Outdoor Unit) The outdoor unit pressure is above the required limit. The system will shut down.	Unit pressure is above the upper limit. System is shut down. Confirm that the system is properly charged with refrigerant. Check condenser fan motor, TXV, indoor unit blower motor, stuck reversing valve or clogged refrigerant filter. Confirm that the outdoor unit is clean. The alarm clears after the pressure switch closes or a power reset
413	Critical	(Outdoor Unit) The high pressure switch has opened 5 times during a single demand. As a result, the thermostat has shutdown the outdoor unit.	Open high pressure switch error count reached 5 strikes. Check system charge using approach and sub cooling temperatures. Check outdoor fan operation. Check for dirt or debris blocking air flow to outdoor unit. Reset by putting outdoor unit control in test mode or resetting low voltage power.
414	Critical	(Outdoor Unit) The discharge line temperature is higher than the recommended upper limit of 279°F.	Discharge line temperature is > 279°F. Make sure coil is clean and airflow unobstructed in and out of condenser. Check system operating pressures and compare to unit charging charts in installation manual. Clears after discharge temperature is < 225°F.

Table 1. Alert Codes and Troubleshooting

Critical alerts are displayed on Home (user) screen, in the Homeowner alert button, and in the Installer alert button. Minor and Moderate alerts are found only in the Installer alert button.

Alert Code	Priority	Alert Text	Steps to clear
415	Critical	(Outdoor Unit) The discharge line temperature has been consistently higher than the recommended upper limit of 279°F.	Discharge line high temperature error count reached five strikes. Make sure coil is clean and airflow unobstructed in and out of condenser. Check system charge using approach and sub cooling temperatures. Reset by putting outdoor board in test mode or resetting low voltage power.
416	Critical	(Outdoor Unit) The outdoor coil sensor is either open, short-circuited or the temperature is out of sensor range. As a result the outdoor unit control will not perform any defrost tempering.	Sensor being detected open or shorted, or temperature is out of sensor range. Outdoor unit control will not perform demand or time/temperature defrost operation. (System will still heat or cool.) Clears when outdoor unit control detects proper sensor readings.
417	Critical	(Outdoor Unit) The outdoor unit sensor is either open, short-circuited or the temperature is out of sensor range. As a result the outdoor unit control will not perform any defrost tempering.	Outdoor unit control detects open or shorted sensor, or temperature that is out of sensor range. Critical Alert after 10 minutes. Reset by replacing sensor. This fault is detected by allowing the unit to run for 90 seconds before checking sensor resistance. If the sensor resistance is not within range after 90 seconds, the board will count one fault. After 5 faults, the board will lock out. Check for proper sensor reading and attachment to line. Replace if out-of-specifications.
417	Moderate / Critical	(Damper Control Module) The damper control discharge air temperature sensor is either open, short-circuited or the temperature is out of sensor range. As a result the outdoor unit control will not perform any defrost tempering.	The damper control module detects open or shorted discharge sensor, or temperature that is out of discharge sensor range. Check the resistance of the discharge sensor and compare to temperature resistance chart - replace if needed. Reset by replacing the discharge sensor. This fault is detected by allowing the unit to run for 90 seconds before checking discharge sensor resistance. If the discharge sensor resistance is not within range after 90 seconds, the control will count one fault. After 5 faults, the control will lock out. Check for proper sensor reading and attachment to line. The alarm clears after a power reset.
418	Moderate	(Outdoor Unit) There is a faulty "W" output circuit.	W terminal is energized while in cooling mode . Possible cause may be a stuck closed relay on the control, or something external to the control that is energizing W terminal when it should not be energized. Solution: Disconnect any wiring from the W terminal. If 24 volts is still on the terminal, then it is a stuck relay. If the 24 volts disappears, then there is a need to check any of the wires hooked up to the W terminal.
419	Critical	(Outdoor Unit) The "W" output on the outdoor unit has reported more than 5 errors. As a result, the system has shutdown the outdoor unit.	The W output (code E418) on the outdoor unit has reported more than five strikes. As a result, the system has shut-down the outdoor unit. Disconnect thermostat lines from W and verify 24VAC on the W. If 24VAC is present, replace the control.
420	Critical	(Outdoor Unit) The "W" output terminal on the outdoor unit is not wired correctly	Defrost cycle lasts longer than 20 minutes. Check heat pump operation. Cleared when W1 signal is removed. Applicable only in communicating mode with non-communicating heat pump.

Table 1. Alert Codes and Troubleshooting

Critical alerts are displayed on Home (user) screen, in the Homeowner alert button, and in the Installer alert button. Minor and Moderate alerts are found only in the Installer alert button.

Alert Code	Priority	Alert Text	Steps to clear
421	Critical	Air Handler / Equipment Interface Module). The heat pump defrost cycle has taken more than 20 minutes to complete.	Voltage sensed on W output terminal when Y1 out is deactivated.
422	Moderate	Compressor top cap switch exceeding thermal limit.	Check condenser fan motor, TXV, indoor unit blower motor, stuck reversing valve or clogged refrigerant filter. Automatically clears when error is corrected.
423	Moderate / Critical	The inverter has detected a circuit problem.	Control will lockout after 10 strikes within an hour. To clear disconnect power to outdoor unit and restart.
424	Moderate	The liquid line temperature sensor has malfunctioned.	In normal operation after outdoor control recognizes sensors, the alarm will be sent if valid temperature reading is lost. Compare liquid line sensor resistance to temperature/resistance charts in unit installation instructions. Replace sensor pack if necessary. At the beginning of (any) configuration, furnace or air-handler control will detect the presence of the sensor(s). If detected (reading in range), appropriate feature will be set as 'installed' and shown in the iComfort Wi-Fi® thermostat 'About' screen. The alarm / fault will clear upon configuration, or sensing normal values.
425	Minor	Outdoor control has increased minimum compressor speed to allow for proper oil return due to low ambient temperature.	Outdoor ambient temperature is below system limit. Control will attempt to run at lowest allowed compressor speed to allow for proper oil return. Automatically clears when outdoor ambient temperature rises above limit for more than 5 minutes.
426	Critical	Excessive inverter alarms	After ten faults within one hour control will lockout. To clear disconnect power to outdoor unit and restart. Inverter alarms 12 to 14 and 53 do not count towards this lockout condition.
427	Moderate / Critical	The inverter has detected a DC peak fault condition.	If condition (55A or higher) is detected, outdoor unit will stop (compressor and fan). Anti-short cycle is initiated. If peak current (55A or higher) occurs 10 times within an hour, system will lockout. To clear, disconnect power to outdoor unit and restart.
428	Moderate / Critical	The inverter has detected a high main input current condition.	If condition is detected, outdoor unit will stop (compressor and fan). Anti-short cycle is initiated. If condition occurs 10 times within an hour, system will lockout. To clear, disconnect power to outdoor unit and restart.
429	Moderate / Critical	The inverter has detected a DC link low voltage condition.	Error occurs when DC link voltage drops below 14VDC. If condition is detected, outdoor unit will stop (compressor and fan). Anti-short cycle is initiated. If condition occurs 10 times within an hour, system will lockout. To clear, disconnect power to outdoor unit and restart.
430	Moderate / Critical	Compressor start-up failure	If condition is detected, outdoor unit will stop (compressor and fan). Anti-short cycle is initiated. If condition occurs 10 times within an hour, system will lockout. To clear, disconnect power to outdoor unit and restart.

Table 1. Alert Codes and Troubleshooting

Critical alerts are displayed on Home (user) screen, in the Homeowner alert button, and in the Installer alert button. Minor and Moderate alerts are found only in the Installer alert button.

Alert Code	Priority	Alert Text	Steps to clear
431	Moderate / Critical	The inverter has detected a PFC circuit over-current condition.	Error occurs when PFC detects a over current condition of 100A peak. If condition is detected, outdoor unit will stop (compressor and fan). Anti-short cycle is initiated. If condition occurs 10 times within an hour, system will lockout. To clear, disconnect power to outdoor unit and restart.
432	Moderate / Critical	The inverter has detected a DC link high voltage condition.	Error occurs when the DC link capacitor voltage is greater than 480VDC. If condition is detected, outdoor unit will stop (compressor and fan). Anti-short cycle is initiated. If condition occurs 10 times within an hour, system will lockout. System will stop. To clear, disconnect power to outdoor unit and restart.
433	Moderate / Critical	Compressor phase current is too high.	Error occurs when compressor peak phase current is greater than 28A. Inverter will issue code 14 first and slow down to try to reduce the current. If the current remains high, outdoor unit will stop (compressor and fan). Anti-short cycle is initiated. If condition occurs 5 times within an hour, system will lockout. To clear disconnect power to outdoor unit and restart.
434	Moderate / Critical	Outdoor control has lost communications with the inverter for greater than 3 minutes.	This error will occur when communication check-sum error occurs for 3 minutes. Outdoor control will stop all compressor demands, recycle power to the inverter by de-energizing the contactor for 2 minutes.
435	Moderate / Critical	Inverter internal error.	When this error occurs, the outdoor control will cycle power to the inverter by opening the contactor for 2 minutes. Outdoor control will cycle power to the inverter 3 times and then outdoor unit is locked out.
436	Moderate / Critical	Inverter heat sink temperature exceeded limit.	This occurs when the heat sink temperature exceeds the inverter limit. Inverter will issue code 13 first and slow down to try to cool the heat since. If temperature remains high, outdoor unit will stop (compressor and fan). Anti-short cycle is initiated. If condition occurs 5 times within an hour, system will lockout. System will stop. To clear, disconnect power to outdoor unit and restart.
437	Moderate / Critical	Heat sink temperature sensor fault has occurred (temperature less than 4 °F or greater than 264°F after 10 minutes of operation).	This occurs when the temperature sensor detects a temperature less than 0.4°F or greater than 264°F after 10 minutes of operation. If condition is detected, outdoor unit will stop (compressor and fan). Anti-short cycle is initiated. If condition occurs 5 times within an hour, system will lockout. To clear disconnect power to outdoor unit and restart.
438	Moderate / Critical	The inverter has detected a PFC circuit over-current condition.	Error occurs when PFC detects an input over current condition of 35A peak. If condition is detected, outdoor unit will stop (compressor and fan). Anti-short cycle is initiated. If condition occurs 10 times within an hour, system will lockout. To clear, disconnect power to outdoor unit and restart.

Table 1. Alert Codes and Troubleshooting

Critical alerts are displayed on Home (user) screen, in the Homeowner alert button, and in the Installer alert button. Minor and Moderate alerts are found only in the Installer alert button.

Alert Code	Priority	Alert Text	Steps to clear
439	Moderate	Compressor slowdown due to high input current.	Input current is approaching a high limit. Compressor speed will automatically slow down. The control continues sending the inverter speed demanded by the thermostat. The control will set indoor CFM and outdoor RPM to values according to demand percentage rather than the actual Hz. Alarm is automatically clear.
440	Moderate	Compressor slowdown due to high heat-sink temperature.	Heat sink temperature is approaching limit. The compressor speed will automatically slow down to reduce heat-sink temperature. The control will set indoor CFM and outdoor RPM to values according to demand percentage rather than the actual Hz. Alarm is automatically cleared.
441	Moderate	Compressor slowdown due to high compressor current.	Compressor current is approaching high limit. The compressor speed will automatically slow down. The control will set indoor CFM and outdoor RPM to values according to demand percentage rather than the actual Hz. Alarm is automatically cleared.
442	Critical	The top cap switch has opened 5 times within one hour. As a result, the outdoor unit is locked out.	When compressor thermal protection sensor opens 5 times within 1 hour. Outdoor unit will stop. To clear, disconnect power to outdoor unit and restart.
443	Critical	Incorrect appliance unit size code selected.	Check for proper configuring under unit size codes for outdoor unit on configuration guide or in installation instructions. If replacing inverter, verify inverter model matches unit size. The alarm/fault clears after the correct match is detected following a reset. Remove the thermostat from the system while applying power and reprogramming.
530	Moderate / Critical	Low Damper 24VAC Voltage	<ul style="list-style-type: none"> • Damper Supply voltage is < 18VAC. • Maintain non-zone mode for 5 minutes after alarm clears.
532	Moderate	Zoning Pressure Switch Opened (high pressure)	Compressor pressure is above the specified limit. Compressor is turned off. Zoning will be restored once the high pressure switch closes.
542	Moderate / Critical	Zone 1 Temperature Sensor Problem	Invalid temperature reading, Open or short sensor detected. System is restored 30 seconds after fault is recovered.
543	Moderate / Critical	Zone 2 Temperature Sensor Problem	Invalid temperature reading, Open or short sensor detected. System is restored 30 seconds after fault is recovered.
544	Moderate / Critical	Zone 3 Temperature Sensor Problem	Invalid temperature reading, Open or short sensor detected. System is restored 30 seconds after fault is recovered.
545	Moderate / Critical	Zone 4 Temperature Sensor Problem	Invalid temperature reading, Open or short sensor detected. System is restored 30 seconds after fault is recovered.

Table 1. Alert Codes and Troubleshooting

Critical alerts are displayed on Home (user) screen, in the Homeowner alert button, and in the Installer alert button. Minor and Moderate alerts are found only in the Installer alert button.

Alert Code	Priority	Alert Text	Steps to clear
594	Moderate / Critical	(Equipment Interface Module) Pre-coil discharge air temperature sensor problem (DFM mode only). Advances from moderate to critical after ten (10) minutes.	Interlock relay energized, but input not sensed after 3 seconds. No heating and cooling operations. De-energize interlock relay and re-energized 5 minutes later if demand is still present. Alarm clears 5 minutes after fault clears.
600	Critical	Compressor has been cycled OFF on utility load shedding.	Load shedding function: Provides a method for a local utility company to limit the maximum power level usage of the outdoor unit. The feature is activated by applying 24 volts AC power to the L and C terminals on the outdoor control.
601	Critical	Outdoor unit has been cycled OFF on low temperature protection.	Low temperature Protection: Outdoor unit will not operate when the outdoor temperature is at or below -4°F (-20°C). If the unit is operating and the outdoor temperature drops below -4°F (-20°C), the unit will continue to operate until the room thermostat is satisfied or the outdoor temperature drops to -15°F (-26°C). (Outdoor unit ambient sensor provides temperature readings).
700	Moderate	(Thermostat) The temperature sensor in the thermostat is not working properly.	Recalibrate thermostat to clear. Replace thermostat if needed.
701	Moderate	(Thermostat) The thermostat is reading indoor temperatures above the pre-programmed limit.	Recalibrate thermostat to clear; cool thermostat; adjust setpoint. Replace thermostat, if needed.
702	Moderate	(Thermostat) The thermostat is reading indoor temperatures below the pre-programmed limit.	Recalibrate thermostat to clear; warm thermostat; adjust setpoint. Replace thermostat, if needed.
703	Moderate	(Thermostat) The humidity sensor in the thermostat is not working properly.	Recalibrate thermostat to clear; adjust setpoint. Replace thermostat, if needed.
704	Moderate	(Thermostat) The thermostat is reading indoor humidity levels above the pre-programmed limit.	Recalibrate thermostat to clear. Replace thermostat, if needed.
705	Moderate	(Thermostat) The thermostat is reading indoor humidity levels below the pre-programmed limit.	Recalibrate thermostat to clear. Replace thermostat, if needed.
Ohm Check	—	The ohm reading in the system is either too high or too low.	Ohm reading between i+ and i- anywhere on the RSBus with supply power off should be between 70 and 90 ohms. If above 90 ohms, check and repair wiring, splices or other wiring defects that may be causing the excessive resistance. If less than 70 ohms, check for shorted wires.

HOMEOWNER SERVICE ALERT CODES

Number	Value	Number	Value	Number	Value	Number	Value	Number	Value
3000	Filter 1	3002	Humidifier Pad	3004	Maintenance	4000	User Wi-Fi state change, disable	4002	Image file download failed
3001	Filter 2	3003	UV Light	3005	PureAir Maintenance	4001	Firmware download failed		

iComfort™ Communicating System Wiring

DAS NOTE - The discharge air sensor is intended to be mounted downstream of the furnace heat exchanger and air conditioning coil. It must be placed in free airflow, where other accessories (such as humidifiers, UV lights, etc.) will not interfere with its accuracy. Wiring distance between the IFC or AHC and the discharge air sensor should not exceed 10ft when wired with 18-gauge thermostat wire.

OAS NOTE - Wiring distance between the IFC or AHC and the outdoor temperature sensor should not exceed 200ft when wired with 18-gauge thermostat wire.

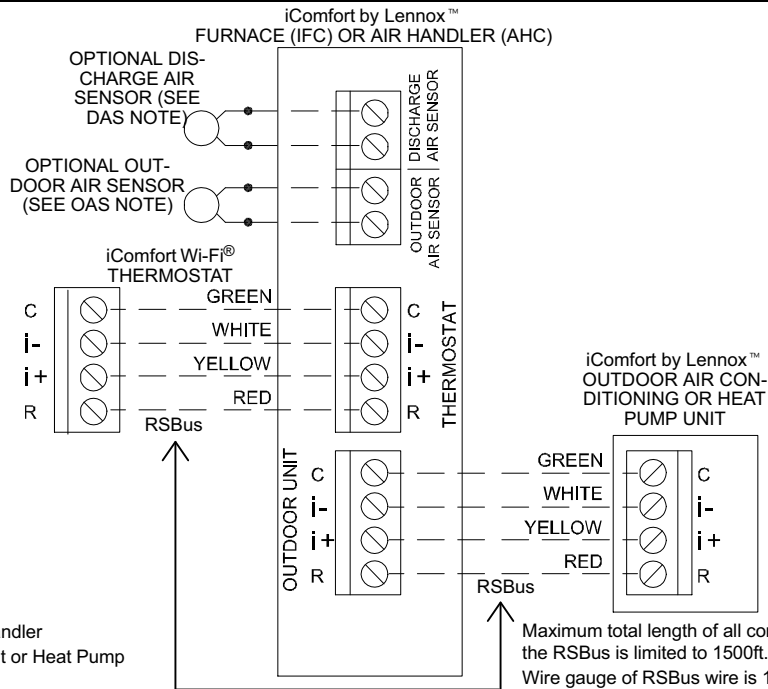

Maximum total length of all connections on the RSBus is limited to 1500ft. Wire gauge of RSBus wire is 18.



iComfort Wi-Fi® Thermostat
 iComfort by Lennox™ Indoor Furnace or Air Handler
 iComfort by Lennox™ Outdoor Condensing Unit or Heat Pump

iComfort™ Communicating Indoor / Non-Communicating Outdoor System Wiring

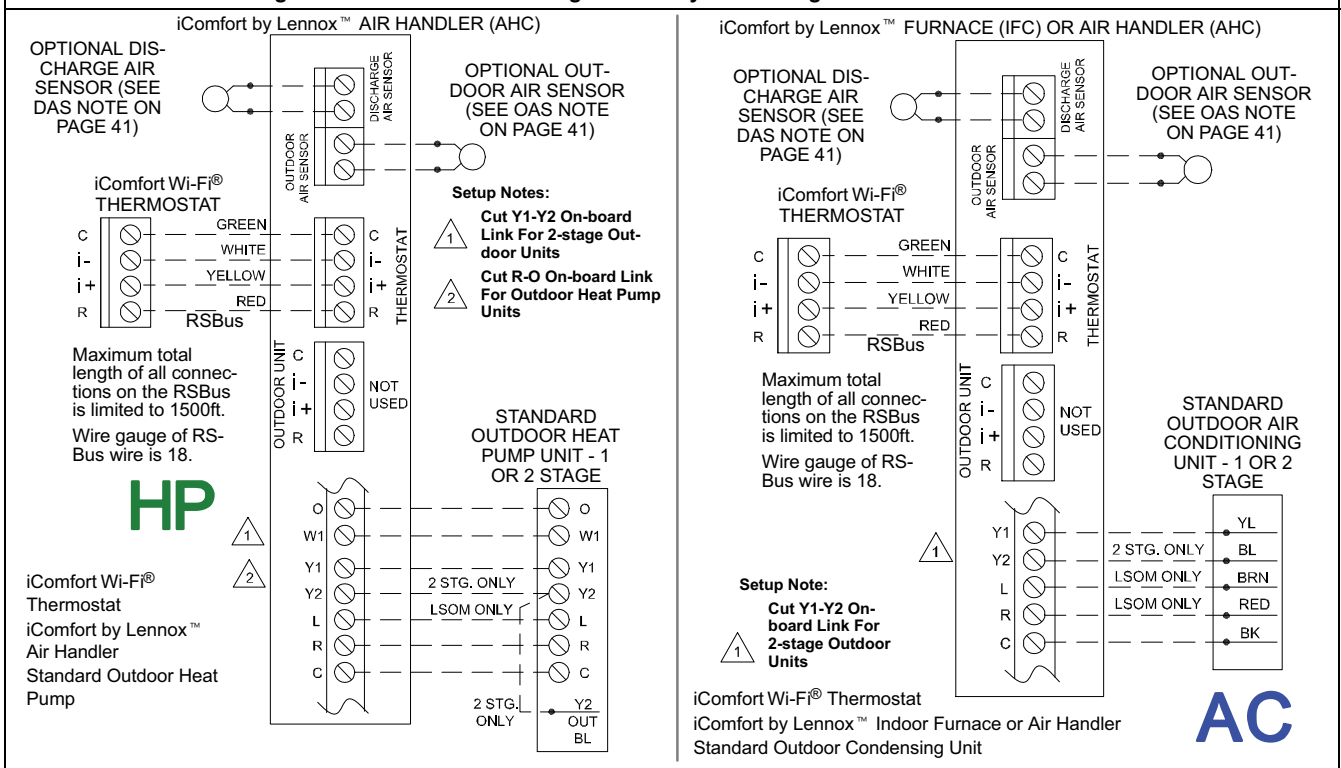

iComfort Wi-Fi®, Equipment Interface Module, Non-Communicating (Conventional) Indoor Unit and iComfort®-enabled Outdoor Unit.

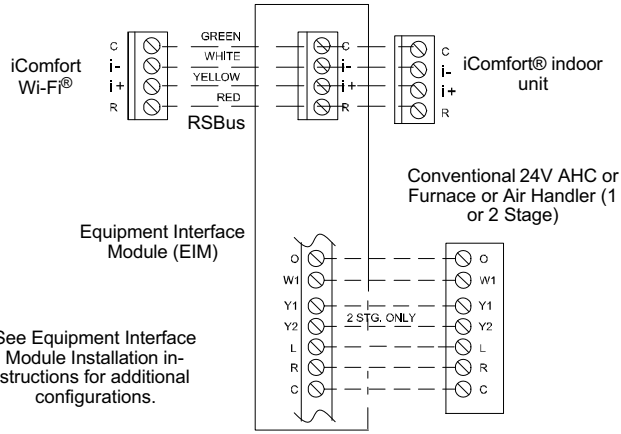

See Equipment Interface Module Installation instructions for additional configurations.

iComfort Wi-Fi®, Damper Control Module and Communicating Indoor / Outdoor Unit

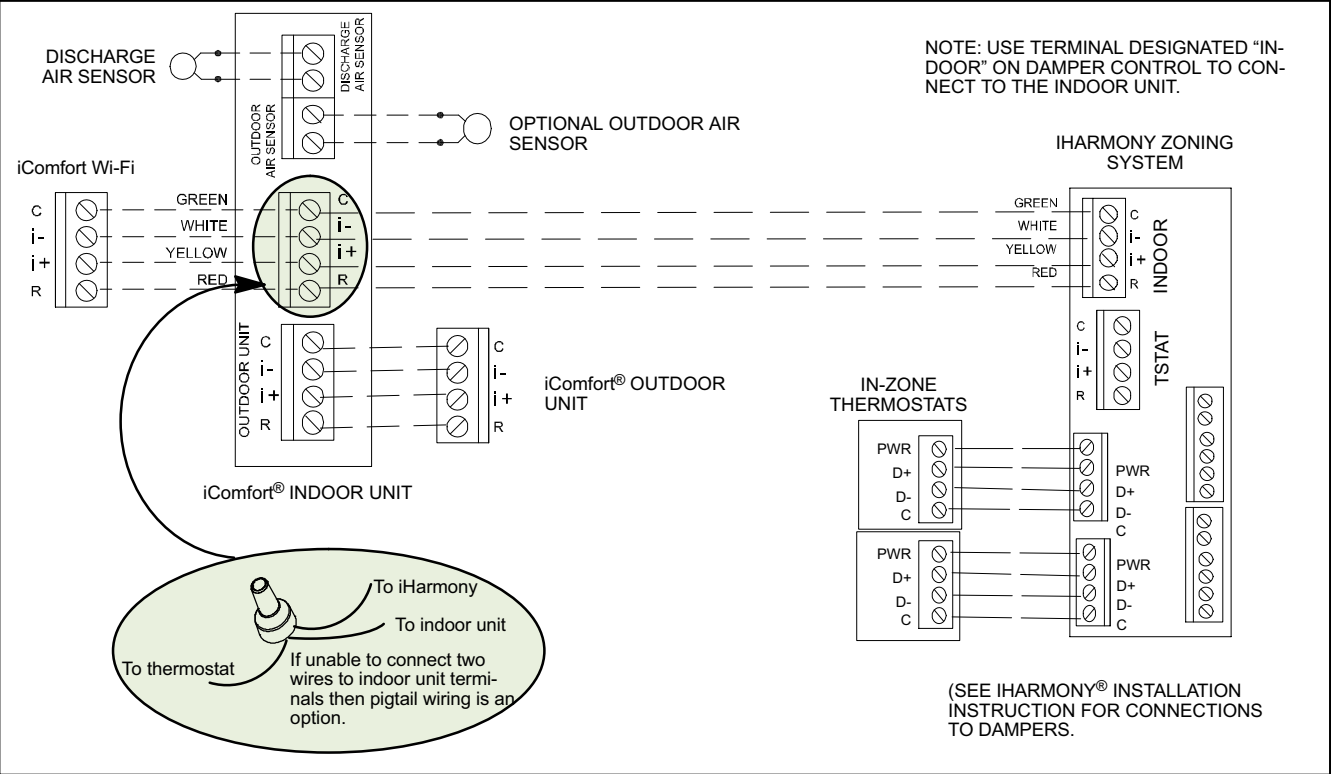

DAS NOTE: The discharge air sensor is intended to be mounted downstream of the heat exchanger and air conditioning coil. It must be placed in free airflow, where other accessories (such as humidifiers, UV lights, etc.) will not interfere with its accuracy. Wiring distance between the IFC or AHC and the discharge air sensor should not exceed 10 feet when wired with 18-gauge thermostat wire.

OAS NOTE: The outdoor temperature sensor wiring distance between the

IFC or AHC should not exceed 200 feet when wired with 18-gauge thermostat wire.

RSBUS NOTE Maximum total length of all connections on the RSBus is limited to 1500 ft. (450 m). Max. length between components is 300 ft. (90 m).

Optional Accessories Wiring FOR USE WITH ANY ICOMFORT BY LENNOX™ SYSTEM

iComfort by Lennox™
SLP98 & G71MPP FURNACE
(IFC) OR AIR HANDLER (AHC)

NOTE: iComfort Wi-Fi® THERMOSTAT SENSES HUMIDITY & CONTROLS 24V "H" OUTPUT (& 120V "H" OUTPUT) TO CYCLE HUMIDIFIER BASED ON DEMAND. NO OTHER CONTROL OR HUMIDISTAT REQUIRED.
OPTIONAL OUTDOOR AIR SENSOR FOR USE WITH HUMIDIFIER (IF NOT ALREADY IN THE SYSTEM FOR OTHER FUNCTIONS. BUILT INTO ALL iComfort by Lennox™ OUTDOOR UNITS). (SEE OAS NOTE ON PAGE 81)

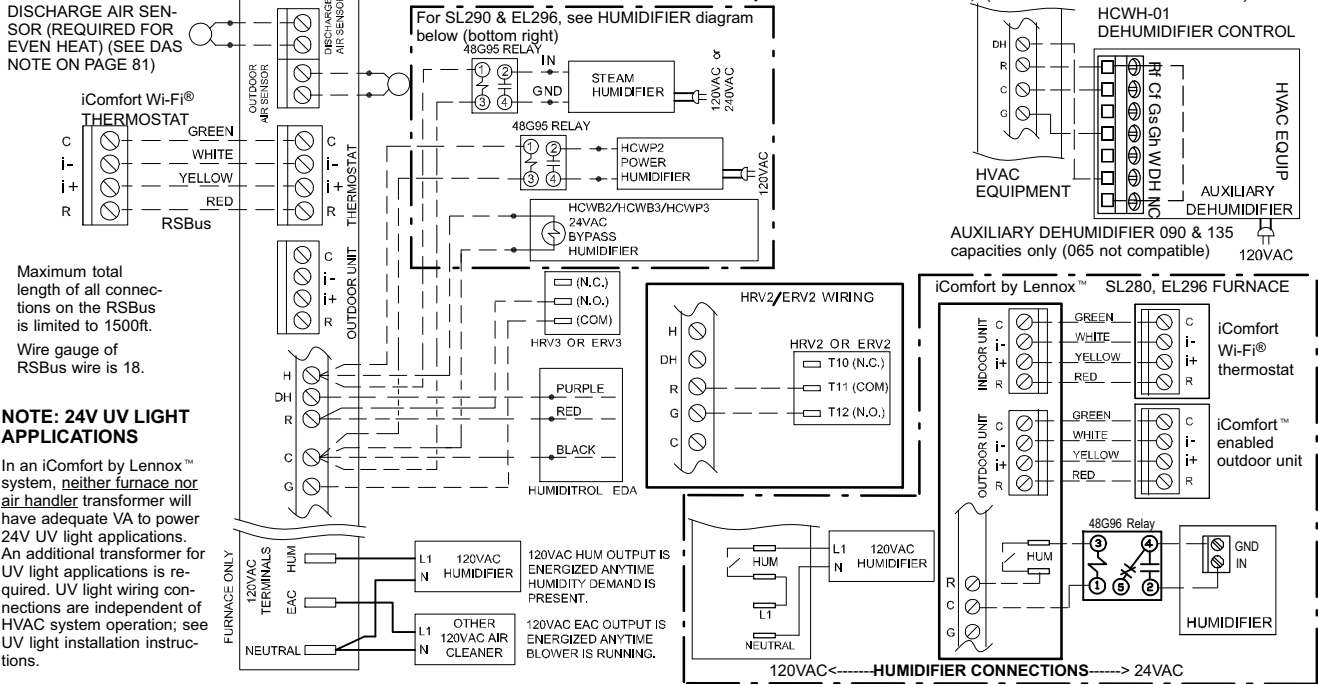

Optional Accessories Wiring FOR USE WITH ANY ICOMFORT BY LENNOX™ SYSTEM

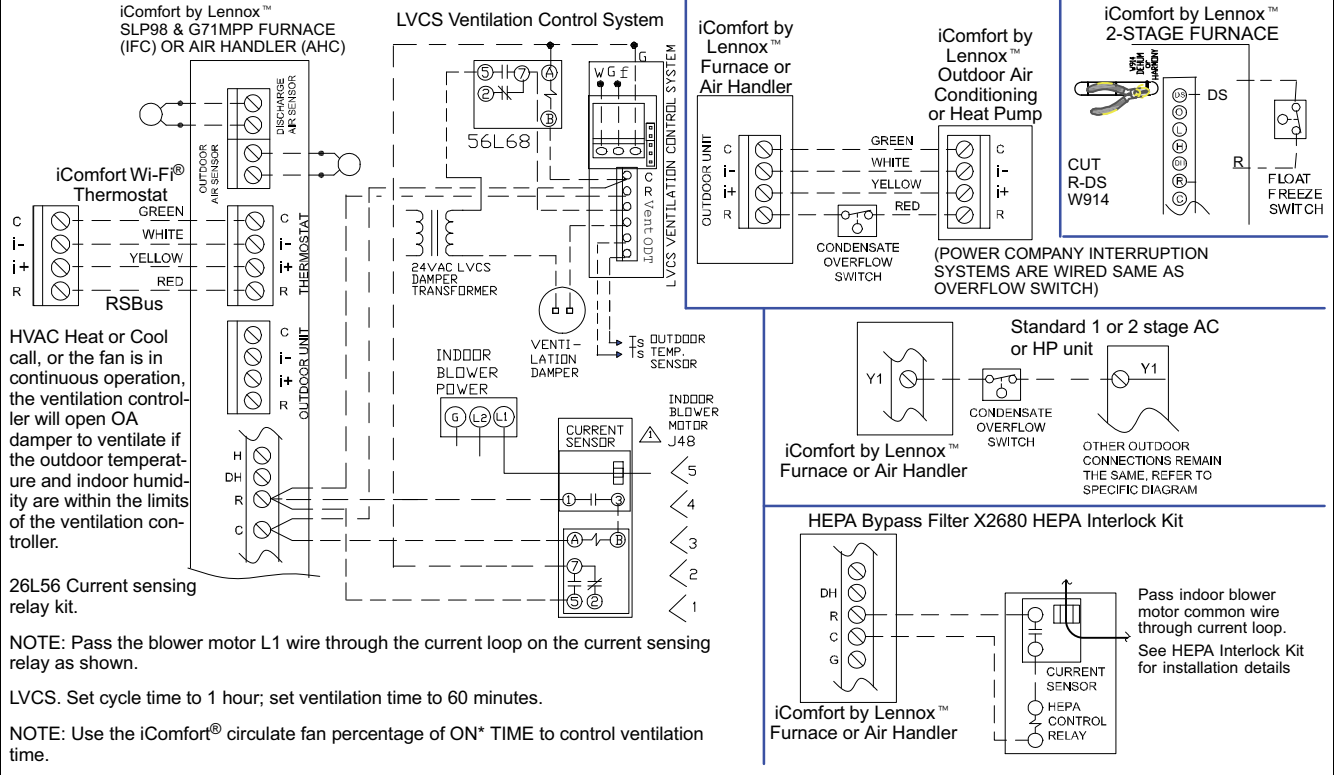

HVAC HEAT OR COOL CALL, OR THE FAN IS IN CONTINUOUS OPERATION, THE VENTILATION CONTROLLER WILL OPEN DA DAMPER TO VENTILATE IF THE OUTDOOR TEMPERATURE AND INDOOR HUMIDITY ARE WITHIN THE LIMITS OF THE VENTILATION CONTROLLER.

LVCS SET CYCLE TIME TO 1 HOUR
 SET VENTILATION TIME TO 60 MINUTES

NOTE: USE THE iComfort CIRCULATE FAN PERCENTAGE OF ON* TIME TO CONTROL VENTILATION TIME

ICOMFORT WI-FI OR S30 SMART HUB CONNECTIONS

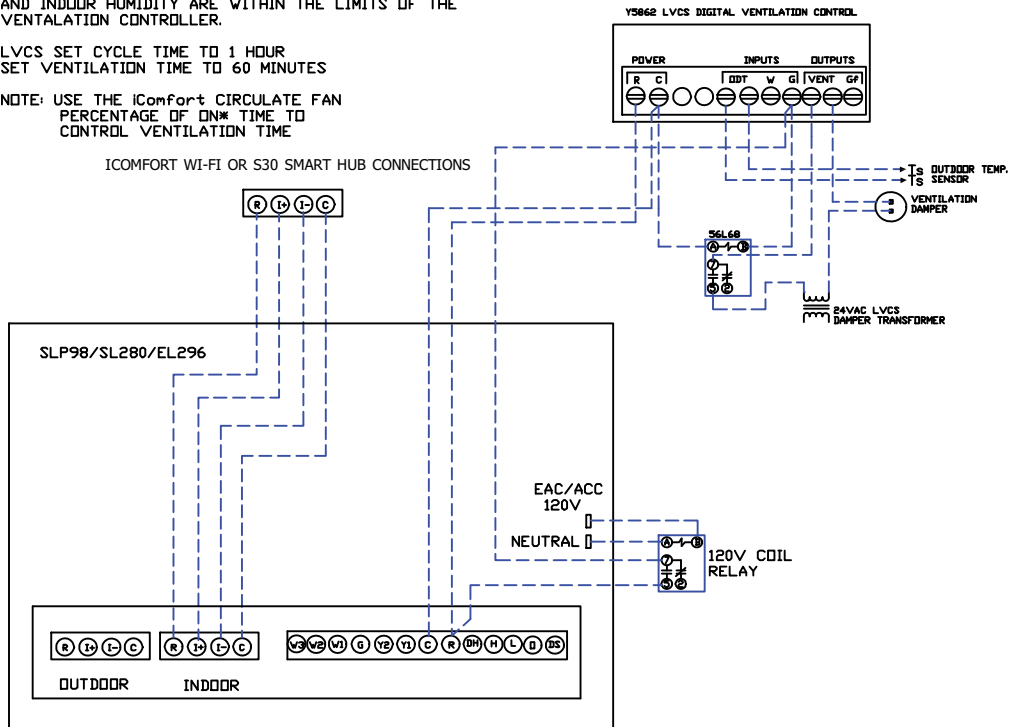

Figure 21. Wiring the Digital Ventilation Controller (iComfort Series Thermostat)

Thermostat Wire Termination in Communicating System

RSBus

Minimum wire size is 18 gauge

Note: iComfort Wi-Fi® thermostat does not require shielded cable wiring.

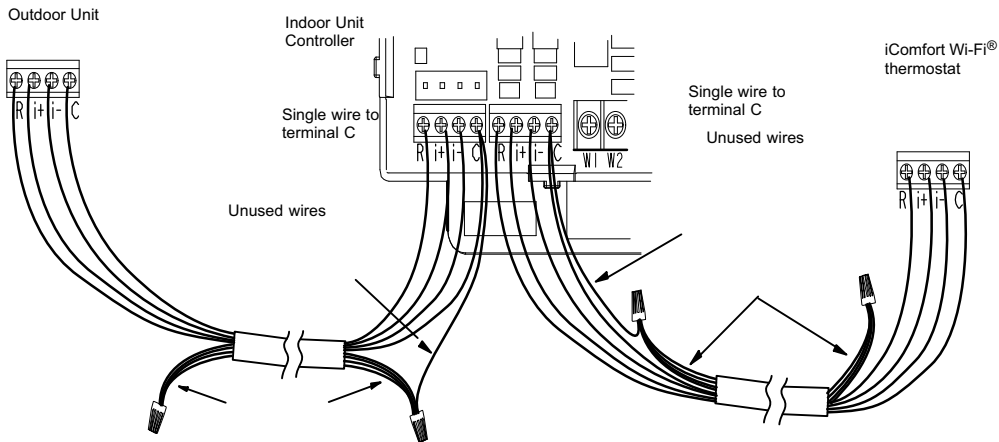

BEST PRACTICES! Keep all communication wiring as far away from house electrical wiring and large electrical appliances as possible (15' [5m] recommended).

Maximum total length of all connections on the RSBUS is limited to 1500 ft. (450 m). Max. length between components is 300 ft. (90 m).

Communicating systems using the iComfort Wi-Fi® thermostat require four thermostat wires between the thermostat and the furnace/air handler control and four wires between the outdoor unit and the furnace/air handler control. When a thermostat cable with more than four wires is used, the extra wires must be properly connected to avoid electrical noise. The wires must not be left disconnected.

Use wire nuts to bundle the unused wires at each end of the cable. A single wire should then be connected to the indoor unit end of the wire bundle and attached to the "C" terminals as shown in the diagram above.

This is not an issue in non-communicating systems.

Configuring Heat Sections on Air Handler Control (AHC)

IMPORTANT: After electric heat strips are installed, the Air Handler Control (AHC) must be manually configured to detect the number of electric heat sections. (SEE ALSO 506181-01 for complete configuration guide.)

This procedure is applicable only to the CBX32MV-XX-230-6-06 and higher and CBX40UHV (all models). To configure the heat strips so that they will be detected by the thermostat:

- Power must be applied to the air handler but NOT to the thermostat. Remove thermostat from base plate or remove wires to thermostat at the air handler.
- On the air handler control (AHC), unit should be in idle mode (decimal blinks at 1 Hertz—0.5 second ON, 0.5 second OFF).
- Select field test mode—touch and hold the push button until solid “-” appears; release button. Display will blink.
- Press the push button and wait for the display LED to show “H” (capital H), then release the button.
- The AHC cycles the indoor blower motor “on” to the selected heat speed and stages the electric heat relays “on” and “off” to automatically detect the number of electric heat sections. The AHC stores the number of electric heat sections, then automatically exits “Field Test Mode”.
- At this point, the iComfort Wi-Fi® will now detect the heat strip information stored in the AHC.

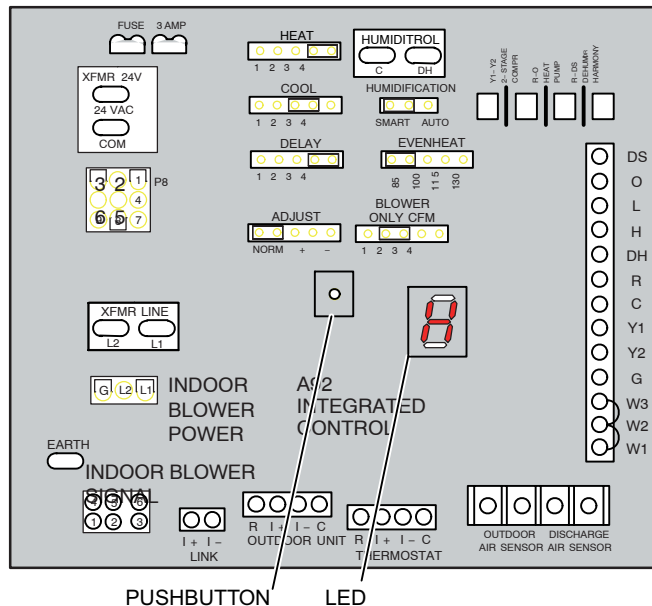

Using the Secure Web Portal

Access all the great Wi-Fi enabled features on your iComfort® thermostat from our secure web portal.

www.myicomfort.com

After signing in, you'll be able to view your iComfort system settings, adjust the temperature and view reminders and alerts – just as you would on your iComfort thermostat at home. With a familiar look and settings this simple, you should feel right at home. Don't forget to check out the available Apps and skins.

From the web portal welcome page, you may also click on links to launch an interactive demo or learn more about iComfort.

Screen-Saver

You can also customize the screen-saver by uploading your own photo on www.myicomfort.com under the tab "skins". Image must be 800x480 DPI in JPG format.

HOW DO I TURN ON SCREEN-SAVER

1. From the thermostat **Home** screen, press **ⓘ**.
2. Press the **display setting** button.
3. Press the **screen saver** button.
4. From the pop-up menu, select either **on** for the default screen-saver or **skins** for your custom uploaded image. The skin picture will appear after 30 seconds of inactivity.
 - When set to **off**, the screen stays on.
 - When set to **on**, after 30 seconds of inactivity the screen will go blank
 - When set to **skins** and no skin or custom image has been uploaded, the screen will display LENNOX after 30 seconds of inactivity. If a skin or custom image has been uploaded, after 30 seconds of inactivity, the image will be displayed.

Accessing Installer Screens and Changing Equipment Parameters

To access the installer screens after the unit has been placed in operation and the user home screen is displayed, touch the "Lennox" logo and hold for 5 seconds. The system will access the installer screens.

A message screen stating "Qualified Lennox equipment installer warning" screen appears.

- When pressing **yes**, the thermostat will search for communicating devices in the system.
- When pressing **no**, the thermostat returns to the main screen.
- When pressing **reset**, the thermostat resets all parameters to factory default, searches for communicating equipment and erases all information concerning non-communicating equipment previously stored in the thermostat.

After initial installation, if an alert is present when you are making changes to settings, no action on the alert is mandatory.

Press **equipment** if you need to set up equipment parameters and edit details of devices in the system.

Press **diagnostics** if you need to analyze the system (see page 18).

If any component of the HVAC system has been changed, e.g. replacing an outdoor sensor, reconfiguring the system will be required. To begin reconfiguring a system (after you have accessed the program from the Lennox logo [previous page]), touch the **setup** button. The "Start system configuration" screen will appear. Press **start** to proceed. The "Re-configure confirmation" screen will appear. This reminder notes that *system configuration* may affect some existing device settings and prompts to **confirm** or **cancel** the configuration process.

Press **confirm** to continue system configuration; the screen will change to the system discovery screen. At this point, the program goes through the same setup as the initial setup process which begins on page 3.

NOTE - "Compatible device found" screen (shown below) appears only when a device has been removed and replaced with a compatible device.

Missing
Device Equipment Type No.
Model No. (control model no.)
Serial No. (control serial no.)

Found Compatible
Device Equipment Type No.
Model No. (control model no.)
Serial No. (control serial no.)

Settings were not copied

ADJUSTING EQUIPMENT PARAMETERS AFTER INITIAL INSTALLER SETUP

1. From the **Home Screen**, touch and hold **Lennox** until the warning screen appears. Press **yes** to continue.
2. Press **equipment** to change equipment parameters and edit details of devices in the system without having to re-run the setup program.
3. Select the **equipment** button to continue. The **system devices** screen will open. Use the arrows to select a device and touch **edit**.
4. Use the arrows to highlight a setting and then touch **edit**.
5. When finished, touch **back**; equipment parameters screen then touch **next**. "Select tests to run screen appears"; either run tests as before or touch **skip tests**.