



© 2014 Lennox Industries Inc.
Dallas, Texas, USA

507441-01
11/2014



V22A
Compact 360° Cassette



V33A
360° Cassette



VOSA
Dedicated Outdoor Air Unit
with Concealed Duct



VMDA
Medium-Static Concealed Duct Unit



VHIA
High-Static Concealed Duct Units



VWMA
Wall-Mounted Non-Ducted Unit



VCFA
Ceiling- or Floor-Mounted
Non-Ducted Unit

VRF

Variable Refrigerant Flow Systems

INDOOR UNITS

USER'S MANUAL

This manual must be left with the user.

⚠ WARNING

ELECTRICAL SHOCK, FIRE, OR EXPLOSION HAZARD.

If you do not follow these instructions exactly, a fire or explosion may result causing property damage, personal injury or death.

Failure to follow safety warnings exactly could result in dangerous operation, serious injury, death or property damage.

Improper installation, adjustment, alteration, service or maintenance can cause property damage, personal injury or loss of life. Installation and service must be performed by a licensed professional HVAC installer (or equivalent), or a service agency.

Any additions, changes, or conversions required in order for the appliance to satisfactorily meet the application needs must be made by a licensed professional installer (or equivalent) using factory-specified parts.

This unit must be properly grounded. The ground wire for the unit must not be connected to a gas or water pipe, a lightning conductor or a telephone ground wire.

Do not use this system if any part has been underwater. A flood-damaged appliance is extremely dangerous. Immediately call a licensed professional HVAC service technician (or equivalent) to inspect the system and to replace all controls and electrical parts that have been wet or to replace the system, if deemed necessary.

Refrigerant leaks are unlikely; however, if a refrigerant leak occurs, open a door or windows to dilute the refrigerant in the room. Turn off the unit and all other appliances that may cause a spark. Call a licensed professional HVAC technician (or equivalent) to repair the leak.

DO NOT spray water on the indoor unit for any reason.

Do not touch the unit or the controller if your hands are wet.

Do not replace a fuse with a fuse of a different rating. Do not use a jumper wire to replace a fuse.

Do not insert your hands, tools or any other item into the air intake or air outlet at either the indoor or outdoor unit.

Do not remove the outdoor unit fan guard for any reason.

⚠ CAUTION

If outdoor unit is installed on a raised stand, check condition of stand occasionally to ensure that it remains stable.

Do NOT install sprinklers or soaker hoses where they can expose the outdoor unit to treated water. Prolonged exposure to treated water will corrode the surface of the steel and aluminum parts and will diminish the performance of the unit.

Do not place items which may be damaged by water under or around the indoor unit.

Ensure that the condensate drain is properly routed to a drain.

Parts Arrangement

V22A or V33A Cassette

Cassette may be adjusted to provide discharge air from one, two, three or four sides.

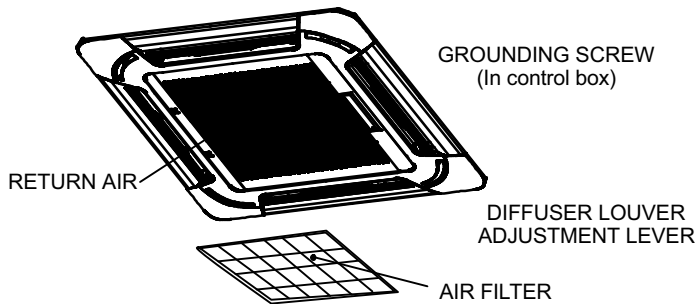

VCFA Ceiling- or Floor-Mounted Non-Ducted Unit

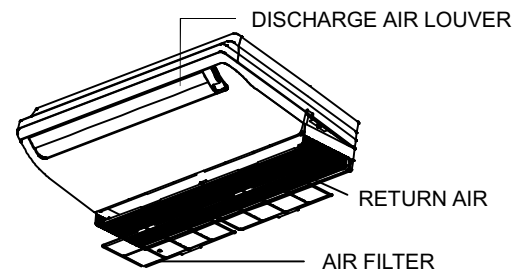

VMDA Medium-Static Concealed Duct

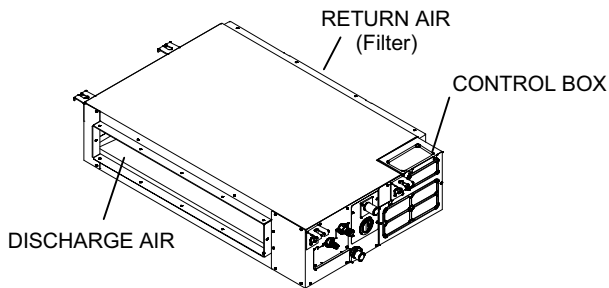

VWMA Wall-Mounted Non-Ducted Unit

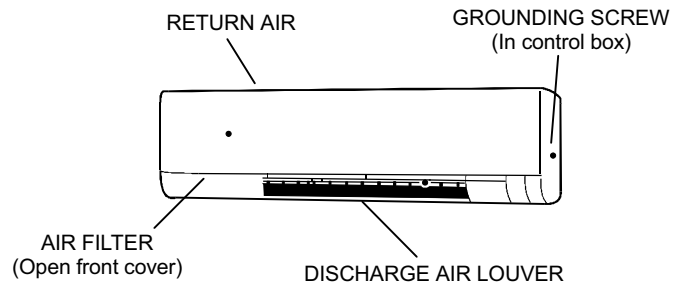

VHIA High-Static Concealed Duct

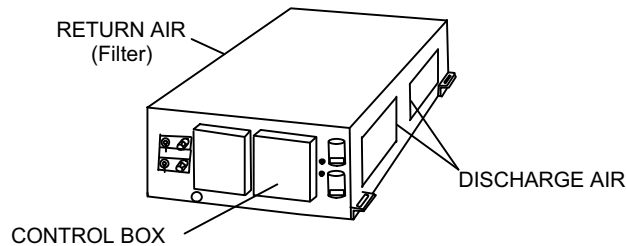

VOSA Dedicated Outdoor Air with Concealed Duct

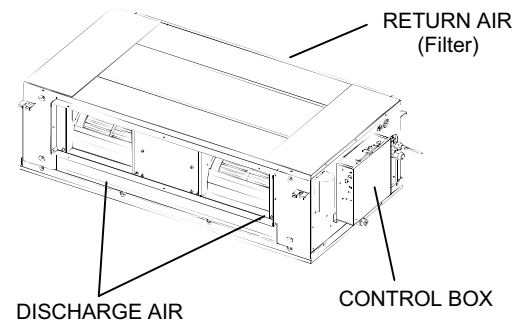

Important Operating Instructions

⚠ IMPORTANT

System operation is controlled by either a wired controller or a remote control. Refer to the manual provided with the control for system operation.

To ensure comfort, make sure that temperature selection has been properly set at the unit controller or remote control.

To ensure efficient operation, do not block air intake or outlet at either the indoor or outdoor unit.

Do not stand on outdoor unit or store items on top of unit.

Make sure that indoor unit directional louvers are properly adjusted.

⚠ CAUTION

DO NOT adjust the louvers by hand. Louvers are adjustable only by using the wired controller or remote control.

V22A or V33A Ceiling-Mounted Cassettes

Adjust the discharge air louvers to direct air downward during heating and outward during cooling.

Heating operation
Adjust louvers downward.

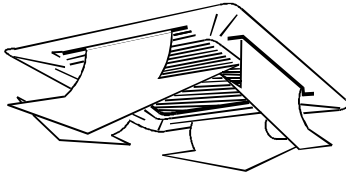

Cooling operation
Adjust louvers outward.

VCFA Ceiling- or Floor-Mounted Units

Use the wired controller or the remote control to set the position of the discharge air louvers. The louvers may be set to automatically swing. In this setting, horizontal louvers will swing outward to downward and vertical louvers will swing left to right. You may also set the louvers so that they are stationary in a single position. It is always recommended to direct the horizontal discharge air louvers downward during heating and outward during cooling.

Auto-swing operation
Set louvers pivot up and down automatically.

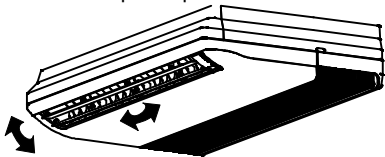

Heating operation
Set horizontal louvers downward.

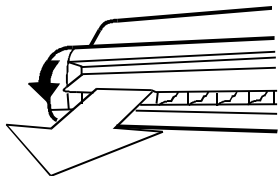

Cooling operation
Set horizontal louvers outward.

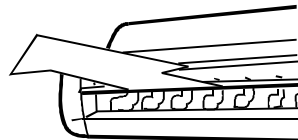

VWMA Wall-Mounted Units

Use the wired controller or the remote control to set the position of the discharge air louvers. The louvers may be set to automatically swing between the outward and downward positions, OR you may set the louvers so that they are stationary in a single position. It is always recommended to direct the horizontal discharge air louvers downward during heating and outward during cooling.

Auto-swing operation
Set louvers pivot up and down automatically.

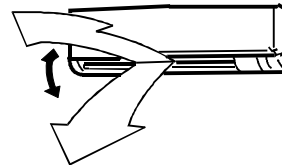

Heating operation
Set horizontal louvers downward.

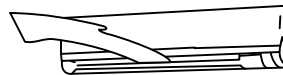

Cooling operation
Set horizontal louvers outward.

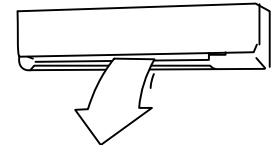

⚠ WARNING

**ELECTRICAL SHOCK, FIRE,
OR EXPLOSION HAZARD.**

Before performing any maintenance, power to unit must be off at the unit disconnect switch.

⚠ CAUTION

Check wiring for signs of loose connections.

Use a clean, dry cloth to wipe the remote control. Never use a damp or wet cloth to clean the remote control.

Use a clean, dry cloth to wipe the indoor unit. If necessary, dampened cloth may be used.

Do not use a chemically treated dust cloth on either the indoor unit or remote control.

Do not use benzene, paint thinner, polishing powder or similar products to clean the indoor unit or control. These substances may cause the plastic surface to crack or become damaged.

Return Air Filters

Blocked or dirty return air filters affect system operation and efficiency. Air filters should be checked monthly in order to ensure proper air flow to the indoor unit. It may be necessary to check the filter more frequently if the unit is installed in an area with a large amount of dust.

The filter may be removed and cleaned, or it should be replaced with a filter of like kind and size if it is impossible to clean the filter. Refer to the parts arrangement illustrations on page 3 to locate the filter in your indoor unit.

V22A and V33A filters are accessed through the return air grille as shown in the illustration which follows.

Typical Filter Removal V22A or V33A Ceiling-Mounted Cassettes

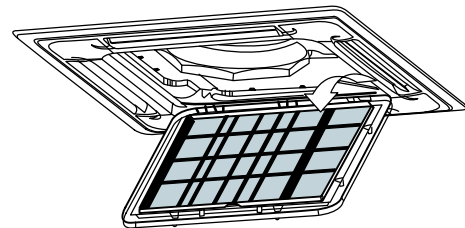
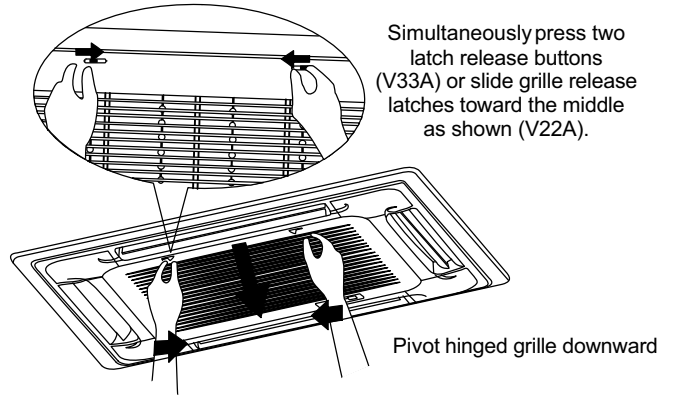

Lift filter up and out to remove it from the unit.

Filter Cleaning

The filter may be cleaned using either a vacuum cleaner or with clean water.

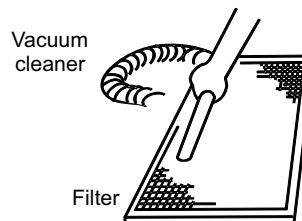

Filter should be held with the air entering side face up when using a vacuum cleaner.

The filter should be held with the air entering side face down when using clean water to wash the filter.

Filter should be set aside to air dry after cleaning. **Do not place filter in direct sunlight or use any type of heat to dry the filter.**

NOTE - If filter is extremely dirty, it may be necessary to use a soft brush and a mild detergent for cleaning. Filter must be thoroughly rinsed and dried.

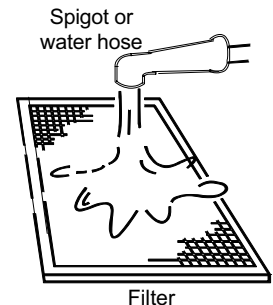

Preparing Unit for Prolonged Idle Periods

The unit must be prepared before lengthy periods of inactivity:

- Set the controller so the the indoor unit operates in the fan only mode for 8 to 12 hours.
- Thoroughly clean and replace return air filters.
- Use a clean, dry cloth to wipe cabinets.
- Turn the unit OFF at the wired controller or remote control; then, disconnect power to the unit.
- Remove batteries from the remote control.

Returning the Unit to Operation after Prolonged Idle Periods

If the unit has been inactive for an extended period of time, it must be prepared for operation:

- Properly clean and replace return air filters.
- Use a clean, dry cloth to wipe unit front panels.
- Insert batteries into the remote control.
- If power was disconnected, reconnect power to the unit for at least 12 hours before returning the unit to operation.

Troubleshooting

WARNING!

ELECTRICAL SHOCK HAZARD! Never attempt to repair the indoor or outdoor unit yourself. System repairs must be performed by a licensed professional HVAC technician (or equivalent).

If any of the following conditions exist, immediately turn the system (indoor and outdoor units) off at the unit disconnect switch and call a licensed professional HVAC technician (or equivalent) for repairs:

- The system does not receive a signal from the remote control or wired controller.
- The remote control or wired controller indicate a system malfunction.
- Water is leaking into the room from the indoor unit.
- The circuit breaker trips or the fuse blows frequently.
- Water or some other liquid has been spilled on or splashed into the indoor unit.

NORMAL OPERATION

If none of the above conditions exist, check the following items before calling for repairs. This can save you both time and money. The following are signs of normal system operation.

System does not operate on command

The indoor fan does not start immediately after the ON/OFF button on the remote control is pressed.

- On an initial call for cooling, the operation/run light is lit to signal normal operation. There will be a delay after a cooling demand is introduced before unit operation begins. This delay protects the unit compressor and is normal.
- When a heating demand is initiated, the operation light is lit to signal normal operation. The PRE-DEF indicator may be lit as well. The indoor unit fan will not operate until the indoor coil reaches a pre-set temperature. This prevents the delivery of cold air into the space and is normal.

Indoor fan is on; compressor is off

In certain normal operating modes, the indoor fan is on when the compressor is not operating.

- The system turns the compressor off and leaves the indoor fan on when the indoor coil falls to a

preset temperature. This is normal operation and will prevent the indoor coil from freezing.

- When the indoor fan is set for continuous operation, the fan continues to run when the temperature setting is reached and the compressor is de-energized.

White mist comes out of the indoor unit

- **During cooling operation**, if the indoor relative humidity is very high and the indoor unit discharge air louvers are very dirty, the indoor coil may freeze and a white mist (frozen vapor) may appear to come from the indoor unit. **In this case, though the unit is not in need of repair, it does need to be cleaned by a licensed professional HVAC technician (or equivalent).**
- **During heating operation when the operation mode switches from defrost to heating**, moisture generated by the defrost process becomes steam and may be seen as it is blown out of the indoor unit.

Sounds can be heard near the indoor unit

During certain parts of the heating or cooling process, low swishing or groaning sounds may be heard near the unit as the system pressures equalize. This is a normal occurrence.

The table below lists possible causes and solutions to some of the most common problems. Please review this information before calling for service.

Symptom	Possible Cause	Possible Solution
Unit does not start.	<ul style="list-style-type: none"> Power failure. Power to unit is OFF or disconnected. Circuit breaker may be tripped or fuse may be blown. Remote control batteries may have lost their charge or unit controller may have malfunctioned. 	<ul style="list-style-type: none"> Wait for power to be restored. Turn on or reconnect power to the unit. Reset circuit breaker or replace fuse. Replace batteries in remote control. Check controller for proper function.
Indoor fan is operating; however, air is not cool.	<ul style="list-style-type: none"> Temperature not properly set at control. Compressor may be kept off by delay. 	<ul style="list-style-type: none"> Check temperature setting at control. Wait for delay to expire.
Unit cycles on and off frequently.	<ul style="list-style-type: none"> Refrigerant charge is incorrect. Air in refrigerant circuit. Compressor malfunction. Improper voltage. System refrigerant circuit is blocked. 	<ul style="list-style-type: none"> Check for refrigerant leaks and properly charge system. Evacuate and properly charge system. Check compressor and replace, if necessary. Check with utility company to provide proper voltage. Clear blockage.
Unit not cooling properly.	<ul style="list-style-type: none"> Indoor and/or outdoor coil are dirty. Air filter is dirty. Air flow around indoor and/or outdoor unit is obstructed. Doors and/or windows are open. Direct sunlight is affecting indoor temperature. Heat source inside is placing a large burden on the system. Suction pressure is low due to possible refrigerant leak. 	<ul style="list-style-type: none"> Clean indoor and/or outdoor coil. Clean or replace air filter. Remove obstructions. Close doors and windows. Use curtains or blinds to block direct sunlight. Reduce burden of heat source. Check for refrigerant leaks and properly charge system.
Unit not heating properly.	<ul style="list-style-type: none"> Doors and/or windows are open. Suction pressure is low due to possible refrigerant leak. 	<ul style="list-style-type: none"> Close doors and windows. Check for refrigerant leaks and properly charge system.
Fan speed cannot be changed.	<ul style="list-style-type: none"> Check the mode listed on the unit display. Fan speed cannot be changed in the AUTO or DRY mode. 	<ul style="list-style-type: none"> Fan speed cannot be changed in AUTO or DRY mode. Change mode to COOL, FAN ONLY or HEAT.
Remote control signal is not being transmitted, even when ON/OFF button is pressed.	<ul style="list-style-type: none"> Batteries may have lost their charge. 	<ul style="list-style-type: none"> Replace batteries.
The TEMP adjustment indicator is not available.	<ul style="list-style-type: none"> Check the mode listed on the unit display. Temperature cannot be adjusted in the FAN ONLY mode. 	<ul style="list-style-type: none"> Change the mode to COOL, HEAT or DRY.
Operation indicator disappears from the display after a period of time.	<ul style="list-style-type: none"> Check to see if display reads TIMER OFF. 	<ul style="list-style-type: none"> Timed operation is terminated at the end of the TIMER period.
TIMER ON disappears from the display after a period of time.	<ul style="list-style-type: none"> Check to see if display reads TIMER OFF. 	<ul style="list-style-type: none"> Timed operation is terminated when time period has expired.
No tones being sounded by indoor unit, even when ON/OFF button is pressed.	<ul style="list-style-type: none"> Infra-red receiver must be able to see signal from remote control. Batteries may have lost their charge. 	<ul style="list-style-type: none"> Aim remote control infra-red transmitter directly at receiver. Replace batteries.

Error Codes

Indoor units are equipped with either a small panel with four LEDs that flash to indicate system errors or a digital display that provides an error code. Refer to the appropriate table below to view the error codes. If the unit has a digital display, the error code will replace the temperature setting displayed on the front cover of the indoor unit. If more than one error has occurred, the codes will alternate so that all codes are shown. Make note of the code (E1, EE, etc.), then reset the display by pressing the ON/OFF button on the wireless remote. Press the ON/OFF button a second time to reapply power to system. If code is still displayed, disconnect and restore power at the unit disconnect switch or circuit breaker. If the problem was temporary, the code will not reappear. If the error code reappears after power has been broken and restored at the disconnect switch or circuit breaker, call a licensed professional HVAC service technician.



Flashing LED Lights

LED	Type	Issue	Remarks
OPERATION / RUN LED not lit.	Normal operation	Indoor unit is OFF.	Lights when unit is ON and flashes when system mode changes.
OPERATION / RUN LED lit.	Normal operation	Indoor unit is ON.	Goes out when unit is OFF and flashes when system mode changes.
OPERATION / RUN LED Slow flash	Normal operation	Indoor unit is in standby mode.	Goes out when unit is OFF and flashes when system mode changes.
OPERATION / RUN LED Fast flash	Malfunction	Abnormal reading from indoor coil sensor or return air temp. sensor.	Resets automatically after malfunction clears.
TIMER LED Fast flash	Malfunction	Indoor/outdoor unit communication abnormal.	Resets automatically after malfunction clears.
ALARM LED Slow flash	Malfunction	Abnormal operation — outdoor unit.	Resets automatically after malfunction clears.
ALARM LED Fast flash	Malfunction	Abnormal operation — water level switch.	Resets automatically after malfunction clears.
DEF LED Slow flash	Malfunction	EEPROM error	Resets automatically after malfunction clears.
DEF LED Fast flash	Alarm	Mode conflict	Resets when indoor unit mode switches to heating or is turned OFF.
All 4 LEDs Flash at same time	Alarm	M_Home does not match.	Resets when indoor unit is replaced with properly matched unit or is turned OFF.
TIMER and OPER / RUN LEDs Flash at same time	Alarm	No address on initial power up.	Resets automatically after malfunction clears.

Digital Error Code Display (Indoor Units Only)

Display code	Type	Issue	Remarks
E2	Malfunction	Abnormal reading from return air temp sensor.	Resets automatically after malfunction clears.
E1	Malfunction	Indoor/outdoor unit communication abnormal.	Resets automatically after malfunction clears.
Ed	Malfunction	Abnormal operation — outdoor unit.	Resets automatically after malfunction clears.
EE	Malfunction	Abnormal operation — water level switch.	Resets automatically after malfunction clears.
E7	Malfunction	EEPROM error	Resets automatically after malfunction clears.
E3	Malfunction	Abnormal reading from indoor coil temp. sensor .	Resets automatically after malfunction clears.
E4	Malfunction	Abnormal reading from indoor coil outlet temperature sensor.	Resets automatically after malfunction clears.
E0	Alarm	Mode conflict	Resets when indoor unit mode switches to heating or is turned OFF.
H0	Alarm	M_Home does not match.	Resets when indoor unit is replaced with properly matched unit or is turned OFF.
FE	Alarm	No address on initial power up.	Resets automatically after malfunction clears.

NOTE - The small panel with the four LEDs may be installed inside the louvered panel of the indoor unit. LEDs may not be visible outside of unit. Panel also includes infrared receiver. When using remote, point toward louvered panel.