



©2014 Lennox Industries Inc.  
Dallas, Texas, USA



# INSTALLATION/ OPERATION INSTRUCTIONS

## V0STAT51 Indoor Unit Programmable Controller

### CONTROLS

507458-01  
09/2014

**This manual must be left with the owner for future reference.**

### **⚠ WARNING**

Improper installation, adjustment, alteration, service or maintenance can cause property damage, personal injury or loss of life. Installation and service must be performed by a licensed professional HVAC installer (or equivalent) or service agency.

### **IMPORTANT!**

Frequent changes to operating mode may cause system malfunction. Allow at least one minute between mode changes to allow the system to stabilize.

## Shipping and Packing List

<b>Package 1 of 1 contains;</b>	2 – Plastic spacers
1 – Wired Controller	1 – Installation and operation manual
1 – Lithium battery	1 – Cable with connector (66 ft)
2 – Phillips screws	

## General

The V0STAT51 is a wired programmable local controller for VRF Heat Recovery and Heat Pump indoor units with convenient timed schedules for daily operation. These instructions are intended as a general guide and do not supersede local codes in any way. Consult authorities having jurisdiction before installation.

## Requirements

Be sure that power supply has been turned off before beginning installation. This controller should be used only as described in this manual. Do not install the controller on outside walls (where there is unconditioned space on opposite side of wall) or in locations where direct sunlight may be present.

## Installation

### ⚠WARNING

Be sure that power supply has been turned off before beginning installation.

### ⚠CAUTION

Clean controller using a clean, damp cloth. Do not spray cleanser on or around controller.

### ⚠WARNING

Do not operate controller with wet hands.

### ⚠CAUTION

Do not install controller in areas where heavy oil, vapor, or gases containing sulfur may exist or the controller may be damaged.

### IMPORTANT!

Read all of the information in this manual before using this controller. All wiring must conform to local and national building and electrical codes and ordinances. This is a 12 VDC controller. Do not install on voltages higher than 15 VDC.

- This manual provides the installation instructions for this controller. Refer to the included wiring diagram to connect the controller to the indoor unit.
- The controller uses low voltage. Keep a minimum distance of 12" (305mm) between low voltage control wire and high voltage power wires.

### IMPORTANT!

The provided cables must be used. Do not use excessive force while pulling the cable or when making the connections.

- Ground the shielded control wiring.
  - Do not use a megger to test insulation.
  - The controller cable length should not exceed 66 ft.
1. Connect controller to indoor unit main control board by inserting the plug of the 4-conductor cable into the socket provided at the indoor unit

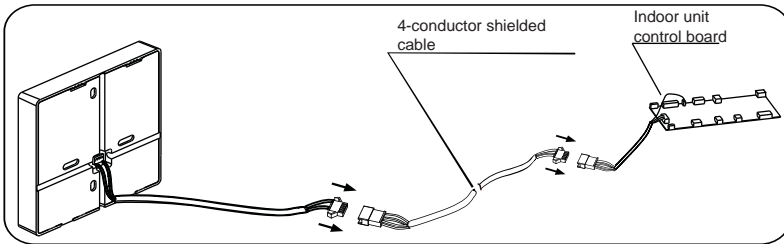
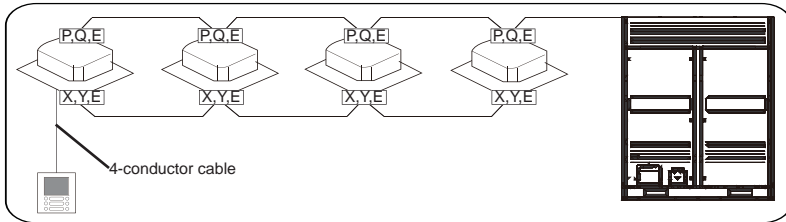

Figure 1. Wiring Connections

2. The controller can be connected to up to 16 indoor units. For connections to multiple indoor units, connect to the first indoor unit with 4-conductor cable, then daisy chain control wiring to each indoor unit using the X,Y and E terminals in the electrical control box of the indoor unit.

**NOTE** – All of the indoor units connected to the controller must be on the same refrigerant circuit, connected to the same outdoor unit.



**Figure 2. Connect multiple indoor units to single controller**

3. Remove the cover from the wallplate using a flat-head screwdriver as shown.

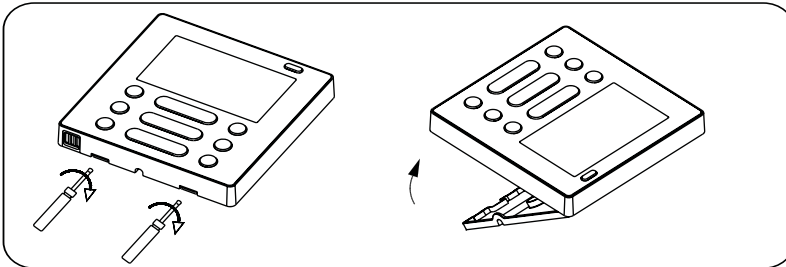

**Figure 3. Remove the cover from the wallplate**

4. Install the provided lithium battery as shown.

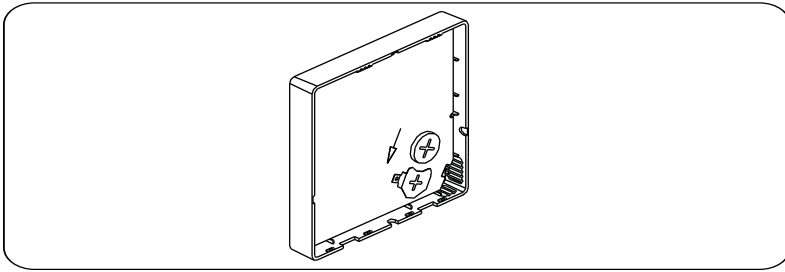
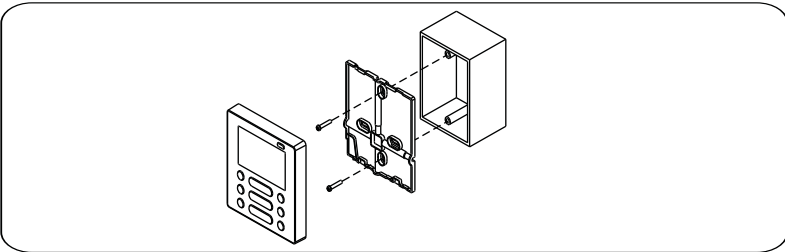

**Figure 4. Install lithium battery**

5. Adjust the length of the two plastic spacers as needed to allow the controller to be mounted flush with the wall. **NOTE** – Provide for future maintenance by allowing enough slack in the wiring to allow the controller to be removed from the wall if needed.

6. Attach the wallplate using the provided screws.

7. Reattach the cover to the wallplate.



**Figure 5. Mount wallplate**

## Field Wiring Diagram

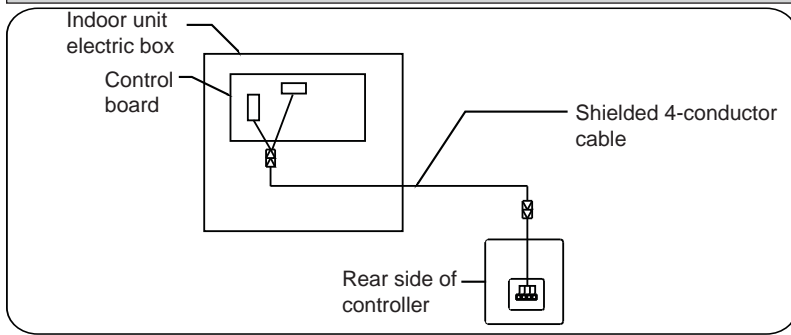

Figure 5. Typical wiring diagram between wired controller and indoor unit

## Specifications

Table 1. Specifications

Input voltage	12 VDC
Ambient temperature	23~110°F (-5~43°C)
Ambient humidity	RH40%~RH90%

# Display

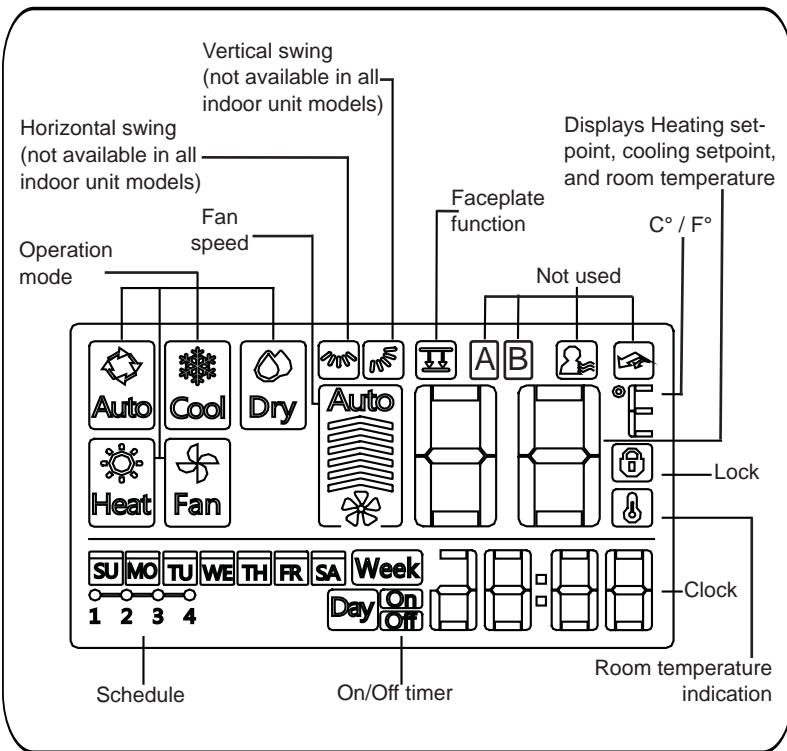

## Description of Buttons

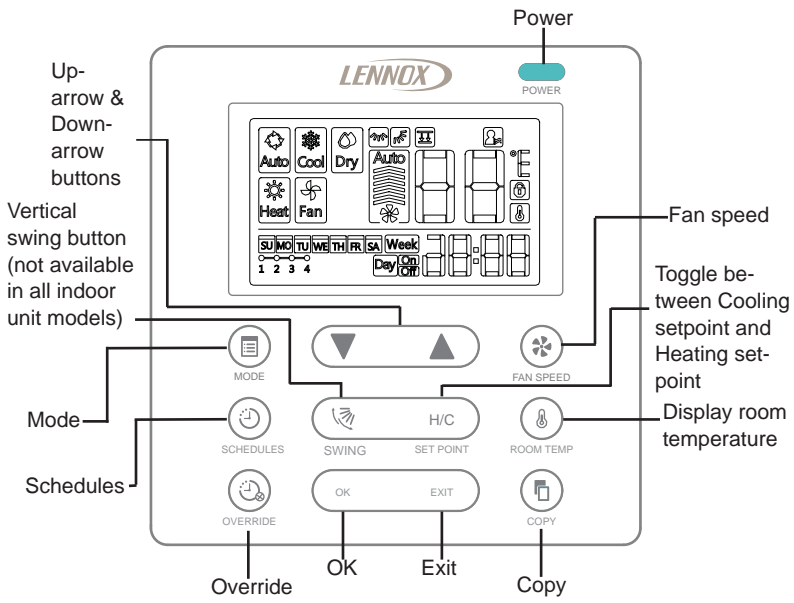



## Setup

### Set the current day and time

1. Press and hold the Schedules button for 3 seconds.
2. Use the up-arrow & down-arrow buttons to set the day. The selected day will blink.
3. Press the Schedules button to complete the date setting.
4. Use the up-arrow & down-arrow buttons to set the current time. **NOTE** – *the controller uses a 24-hour clock.*
5. Press the Schedules button to complete the time setting.

### Select Fahrenheit or Celsius for display

1. Press and hold Exit button and Copy button simultaneously for 3 seconds.
2. Use the up-arrow & down-arrow buttons to toggle between °F and °C.
3. Press the OK button to accept and move to the next setting.

### Identify system as either Heat Pump or Heat Recovery

1. Press and hold Exit button and Copy button simultaneously for 3 seconds.
2. Press the OK button.

3. Use the up-arrow & down-arrow buttons to toggle between 33 (HR) and 32 (HP).
4. Press the OK button to accept and move to the next setting.

### Set Setpoint Differential between Cooling and Heating setpoints

1. Press and hold Exit button and Copy button simultaneously for 3 seconds.
2. Press the OK button 2 times.
3. Use the up-arrow & down-arrow buttons to scroll between 2°, 3°, 4°, and 5°.
4. Press the OK button to accept and move to the next setting.

### Key Pad Tone (beep)

1. Press and hold Exit button and Copy button simultaneously for 3 seconds.
2. Press the OK button 3 times.
3. Use the up-arrow & down-arrow buttons to toggle between 50 (no beep) and 5b (beep).
4. Press the OK button.

## Schedule

### Create Schedules (up to 4 events per day)

1. Press the Schedules button.
2. Press the OK button.
3. Use the up-arrow & down-arrow buttons to select the day you want to set up the schedule (defaults to the current day)
4. Press the OK button.
5. Set begin time for the 1st event using up-arrow & down-arrow buttons. (10 minute increments)
6. Press the OK button.
7. Set the end time for the 1st event using up-arrow & down-arrow buttons. (10 minute increments)
8. Press the OK button.
9. Set cooling setpoint for the 1st event using up-arrow & down-arrow buttons.
10. Press the OK button.
11. Set heating setpoint for the 1st event using up-arrow & down-arrow buttons.
12. Press the OK button.
13. Set begin time for the 2nd event using up-arrow & down-arrow buttons.

Continue with steps 7-12 to setup the 2nd event.

14. Press the OK button to move to the next day.

### Copy Schedule

1. Use the up-arrow & down-arrow buttons to select day you want to copy.
2. Press the Copy button.
3. Use the up arrow & down arrow buttons to select day you want to copy to.
4. Press the Copy button again to confirm.

### Override Schedule

When the controller schedule is on, use the Override button to override the schedule for a limited amount of time. At the end of the override period, the controller will return to the current scheduled event.

1. Press the Override button once. 0h displays.
2. Press the Override button two times, 1h displays, to override the schedule for 1 hour.
3. Press the Override button three times,

2h displays, to override the schedule for 2 hours.

## Operation

### Start/stop operation

Press the LED power button.

- Controller ON: LED power button lit brightly.
- Controller OFF: LED power button not lit.

### To set (or change) the room temperature setting (setpoint)

Press the up-arrow & down-arrow buttons to set the setpoint.

### To set the operation mode

Press the Mode button to scroll through the mode selections.

- Auto – System operates in cooling or heating mode as determined by the setpoint and the room temperature.
- Cool – System operates in cooling mode.
- Dry – System removes humidity according to preset conditions (fan speed and setpoint temperature, not a humidistat sensor). Cannot adjust fan speed.
- Heat – System operates in heating mode.
- Fan – Fan only, no heating or cooling.

## Troubleshooting

### Fault Codes (indoor unit)

F0	Wired remote controller and indoor unit communication failure
E1	Indoor unit and outdoor unit communication failure
E2	T1 sensor malfunction
E3	T2A sensor malfunction
E4	T2B sensor malfunction
E7	Indoor unit EEPROM failure
Ed	Outdoor unit malfunction
EE	Condensate pump malfunction