



INSTALLATION/ OPERATION INSTRUCTIONS



VOCTRL75 Indoor Unit Central Controller

CONTROLS
507461-01
09/2014

**THIS MANUAL MUST BE LEFT WITH THE
OWNER FOR FUTURE REFERENCE**

IMPORTANT !

Frequent changes to operating mode may cause system malfunction. Allow at least one minute between mode changes to allow the system to stabilize.

⚠ WARNING

Improper installation, adjustment, alteration, service or maintenance can cause property damage, personal injury or loss of life. Installation and service must be performed by a licensed professional HVAC installer (or equivalent) or service agency.

Shipping and Packing List

Package 1 of 1 contains:
1 - Indoor Unit Central Controller
4 - Plastic Wall Anchors

4 - Screws
4 - 120 Ω Terminating resistors (shown on wiring diagram)

General

The VOCTRL75P-1 is a wired centralized controller for up to 64 indoor units. These instructions are intended as a general guide and do not supersede local codes in any way. Consult authorities having jurisdiction before installation.

Requirements

Be sure that power supply has been turned off before beginning installation. This controller should be used only as described in this manual. This controller must be installed indoors.

Installation

⚠ WARNING

Be sure that power supply has been turned off before beginning installation.

⚠ WARNING

Do not operate controller with wet hands.

⚠ CAUTION

Do not install controller in areas where heavy oil, vapor, or gases containing sulfur may exist or the controller may be damaged.

⚠ CAUTION

Clean controller using a clean, damp cloth. Do not spray cleanser on or around controller.

IMPORTANT!

Read all of the information in this manual before using this controller. All wiring must conform to local and national building and electrical codes and ordinances. This is a 24 VAC low-voltage controller. Do not install on voltages higher than 30VAC.

- This manual provides the installation instructions for this controller. Refer to the included wiring diagram to connect the controller to the indoor unit.
- The controller is using low voltage. Keep a minimum distance of 12" (305mm) between low voltage control wire and high voltage power wires. Connect 24VAC power to the terminals R & C of the centralized controller directly.
- Ground the shielded control wiring.
- Do not use a megger to test insulation.

- The signal wire of centralized controller should not exceed 3937 ft. (1200m). AWG 18, 3-conductor shielded cable.
- The communication port between the centralized controller and the network interface of the air conditioner is polarity-sensitive. The X, Y and E must be wired to the corresponding X, Y and E on the other end. Do not cross-connect the signal wires.

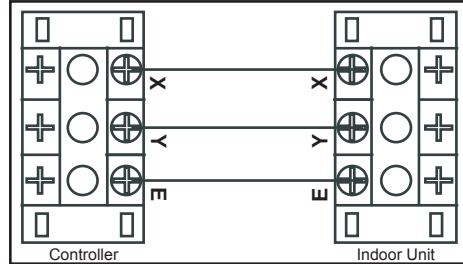

Dimensions

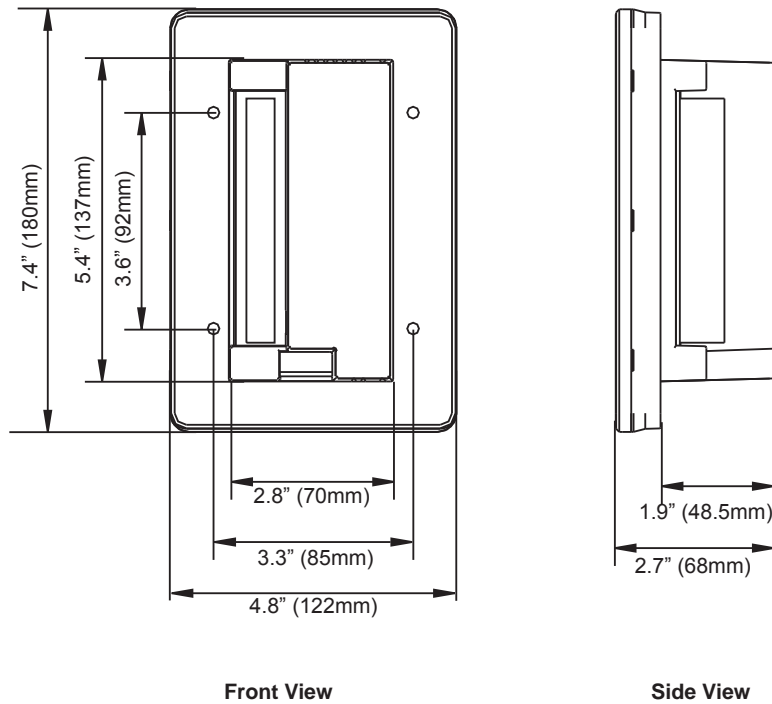

Installation

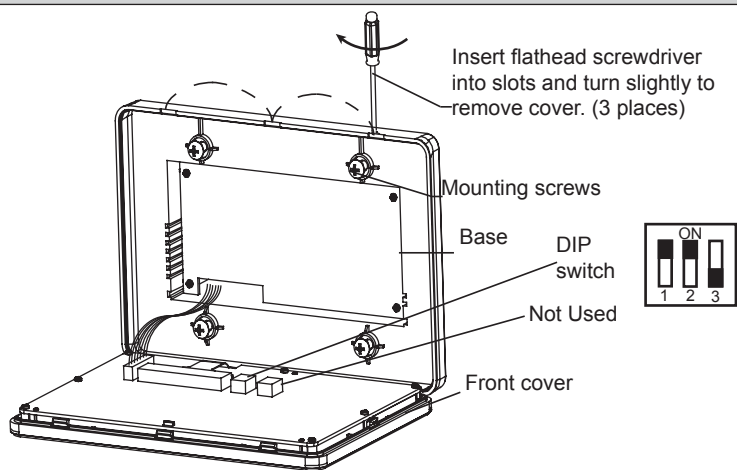

1. The controller can be connected to up to 64 indoor units. For connections to multiple indoor units, connect to the first indoor unit with 3-conductor shielded cable, then daisy chain control wiring to each indoor unit using the XYE terminals in the electrical control box of the indoor unit.
NOTE – Provide for future maintenance by

allowing enough slack in the wiring to allow the controller to be removed from the wall if needed.

2. Remove the cover from the wallplate using a flat-head screw driver as shown.
3. Attach the wallplate using the provided wall anchors and screws.
4. Reattach the cover to the wallplate.

System Wiring

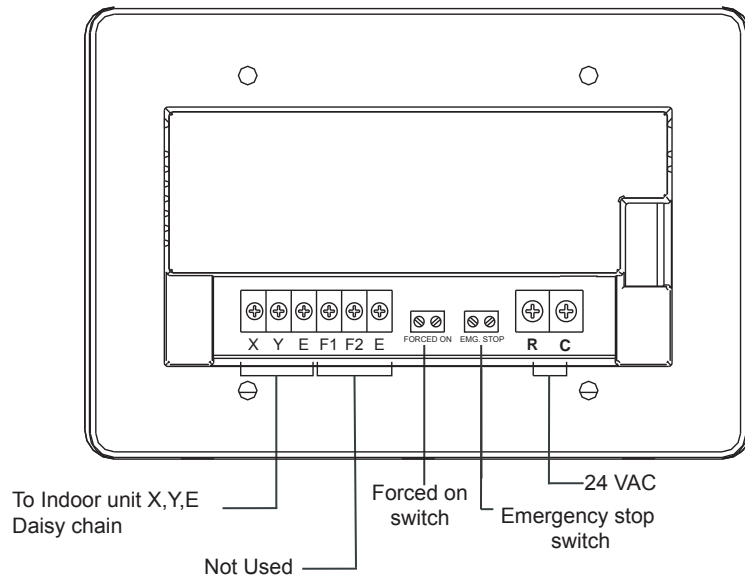

Electrical Terminals (Back of Controller)

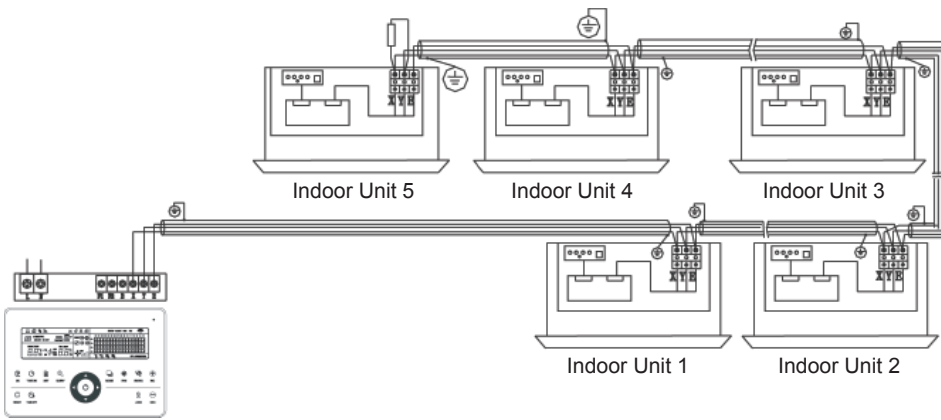

Recommended Daisy Chain Wiring

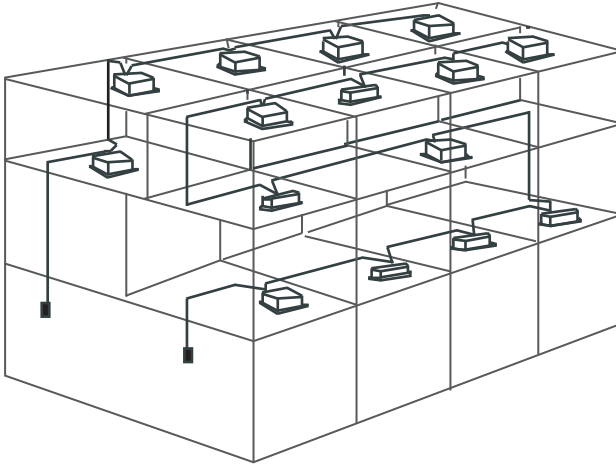

Schematic View Recommended Daisy Chain Wiring

Specifications

Table 1. Specifications

Input voltage	24 VAC
Ambient temperature	5~110°F (-15~43°C)
Ambient humidity	RH40%~RH90%

Operation

Red LED Status Indicator

- **On**
 - One or more indoor units connected to the centralized controller is operating.
 - The centralized controller is transmitting a command to one or more of the connected indoor units.
- **Off**
 - None of the indoor units connected to the centralized controller are in an operation mode.
- **Flashing**
 - A slow (2 Hz) flash indicates an indoor unit error or communication error.

Backlight

- **On**
 - Press any button (but Reset) to turn on backlight.
 - The backlight will remain on while the centralized controller is being operated by the user.
- **Off**

- The backlight will turn off after 30 seconds of inactivity by the user.

Beep

A beep will sound when a function command is entered by the user and when the controller is reset or powered on.

Power on or reset

When the centralized controller is powered on or reset:

- The controller will beep for 2 seconds.
- LCD screen display segments will light up for 2 seconds.
- 1 second later, the controller queries the connected indoor units, LCD screen displays the main screen.
- The centralized controller will display the mode setting screen, By default, the first indoor unit to call for a mode will determine the mode of the heat pump system (heat pump systems only).

Emergency Stop and Forced On

Emergency Stop

When the emergency stop terminals are shorted, all connected indoor units will shut off. The centralized controller LED will blink rapidly (.5 Hz).

Forced On

When the forced on terminals are shorted, all connected indoor units will immediately begin cooling operation.

When both forced on and emergency stop are shorted at the same time, emergency stop will take priority.

Locking the centralized controller

Locked

Press and hold the Query button and the Lock button to lock the centralized controller.

- Users cannot change the connected indoor units operation state from centralized controller.
- Users can change the operation state of any connected indoor unit from a local controller.

Unlocked

Press and hold the Query button and the Lock button to unlock the centralized controller.

- Users can change the connected indoor units operation state from centralized controller.
- Users can change the operation state of any connected indoor unit from a local wired or remote controller.

Locking out the local remote controllers

Locks the selected indoor unit so that it will not receive signals from the local remote controller.

On the Centralized Controller Setting screen, press the Lock button to lock/unlock.

- Once locked by the centralized controller, users cannot change the connected indoor units operation state using a local controller.

Operation Mode Locking

Locks the connected indoor units operation mode to heating or cooling mode.

On the Setting screen, choose all of the connected indoor units that you wish to lock/unlock. Press and hold the up-arrow button and the Lock button simultaneously to lock/unlock the selected units.

- Users cannot change the connected indoor units operation mode to one that conflicts with the locked mode. (e.g. When the locking mode is "heating," the indoor unit's operation mode must be "heating" or "fan.")

On & Off Operation

Press the Power button to turn on or turn off any or all connected indoor units.

Individual Indoor Unit Operation

Select the indoor unit you want to operate and press the Power button one short press to turn that unit on or off.

Global Operation

- Press the Power button one short press to turn off all indoor units currently operating.
- If all indoor units are off, press the Power button one short press to turn on all of the indoor units to the currently selected parameters (ex. mode, fan speed, setpoint setting).
- Press the Power button one long press to send all commands to all indoor units whether the unit is currently powered on or off.
 - All indoor units currently off will be turned on.
 - All operating parameter commands will be sent to all indoor units.

Change Operation Mode (Individual Indoor Unit Setting)

1. Use the up, down, left, and right-arrow buttons to navigate to the indoor unit you want to select.
2. Press the Set button to select the indoor unit.
3. Use the Mode, Fan, INC and DEC buttons to set the operation mode and operating parameters such as setpoint setting and fan speed for the selected indoor unit.
4. Press the OK button to send all commands to the selected indoor unit. *NOTE - All commands are sent, not just the ones that have been changed.*

Change Operation Mode (Global Setting)

Press the Set button to select all of the indoor units.

Use the Mode, Fan, INC and DEC buttons to set the operation mode and operating parameters such as setpoint setting and fan speed for the Indoor units.

Press the OK button to send all commands to the selected indoor unit. *NOTE - All commands are sent, not just the ones that have been changed.*

Button Description and Operation

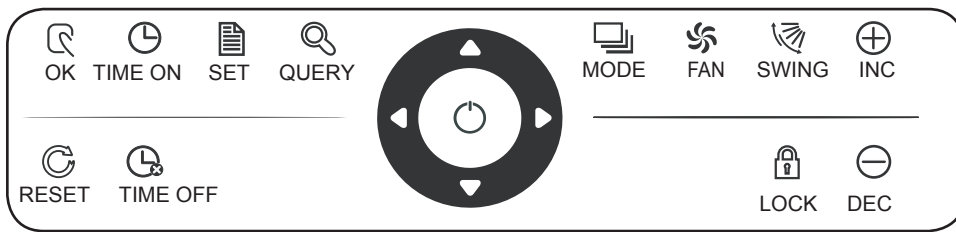

Power button. Use the Power button to turn the selected indoor units on and off.

OK button. While in Settings mode, press the OK button to send all active and updated commands to the selected indoor unit.

TIME ON button. While in Settings mode, press the Time On button to setup delayed-time operation start time for the selected indoor unit. Press the Time On button to set the time to start the indoor unit. Press the Time On button again to turn off the timer mode and return to normal operation.

SET button. Press the Set button to enter Settings mode and to shift between an individual indoor unit setting or a global setting for all indoor units. Defaults to single indoor unit setting. Displays the settings of the first connected indoor unit. Press the Set button twice to select all connected indoor units. Press the Set button repeatedly to shift between single indoor unit setting and global setting.

QUERY button. Press the Query button to query the operation status of the selected indoor unit. Defaults to first connected indoor unit. Use the left-arrow and right-arrow buttons to navigate between indoor units.

Up-arrow & Down-arrow buttons. Use the Up-arrow button and the down-arrow button to select rows. On the Main screen, press the Up-arrow button to enter Query mode. The default is the first connected indoor unit. All other times, press the Up-arrow key to select the next row. On the Main screen, press the Down-arrow button to enter Query mode. The default is the first connected indoor unit. All other times, press the Down-arrow key to select the next row.

Left-arrow & Right-arrow buttons. Use the Left-arrow button and the Right-arrow button to select columns. In Query mode, press the Left-arrow button to

view the operation status of the previous indoor unit. Press and hold the Left-arrow button to scroll through the connected indoor units. In setting mode, in single unit operation mode, press the Left-arrow button to select the previous indoor unit. On the Main screen, press the Left-arrow button to enter query mode. The default is the first connected indoor unit. In query mode, press the Right-arrow button to view the operation status of the next indoor unit. Press and hold the Right-arrow button to scroll through the connected indoor units. When setting operational mode for each unit individually, press the Right-arrow button to select the next indoor unit. On the Main screen, press the Right-arrow button to enter Query mode. The default is the first connected indoor unit.

MODE button. While in Settings mode, press the Mode button to set the operation of a single indoor unit or global setting for all connected indoor units.

FAN button. While in Settings mode, press the Fan button to set the fan speed of the selected indoor unit. Auto → Low → Medium → High.

SWING button. While in Settings mode, press the Swing button to enable or disable louver oscillation function for the selected indoor units. (Not available for all indoor units.)

INC button. While in Settings mode, press the Increase (INC) button to increase the temperature setpoint setting of the selected indoor unit by 1 degree.

While in Settings mode, press the Increase (INC) button to select the next delayed start/stop hour, from 0 to 24 hours, in increments of half hour for first 10 hours, then in increments of 1 hour.

While in Query mode, press the Increase button to move to the next page of indoor units.

RESET. Press the Reset button 5 seconds to reset the centralized controller to factory defaults.

TIME OFF button. While in Settings mode, press the Time Off button to set up delayed-time operation stop time for the selected indoor unit. Press the Time Off button to set the time to shut off the indoor unit. Press the Time Off button again to turn off the timer mode and return to normal operation.

LOCK button. While in Settings mode, press the Up-arrow button and the Lock button at the same time to lock or unlock the operation mode for the system.

Press and hold the Query button and press the

Lock button to lock or unlock the touchpad of the centralized controller.

DEC button. While in Settings mode, press the Decrease (DEC) button to decrease the temperature setpoint setting of the selected indoor unit by 1 degree.

While in Settings mode, press the Decrease (DEC) button to select the previous delayed start/stop hour, from 0 to 24 hours, in increments of half hour for first 10 hours, then in increments of 1 hour.

While in Query mode, press the Decrease button to move to the previous page of indoor units.

LCD Display Icons

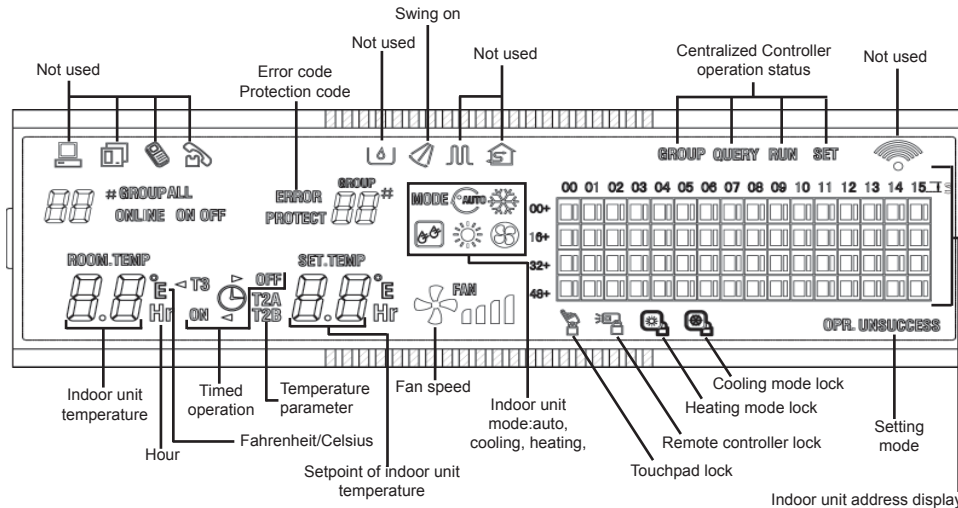

Error code/Protection code. These icons display in the event of a fault code/error.

Swing on. This icon displays when the selected indoor unit's louvers are oscillating.

Operation status. The current operation icon displays.

Indoor temperature display. The return air temperature of the selected indoor unit displays. Display range: 00-99°F/°C. If the temperature is higher than 99°F/°C, "99°F/°C" displays.

Hour. This icon displays the hours set for timed operation when the selected indoor unit is in delay-timed operation.

Fahrenheit/Celsius. The current temperature scale displays, F or C.

Timed operation. This icon displays when the selected indoor unit is in delay-timed operation.

Temperature parameters. T2A, & T2B used for service.

Setpoint temperature display. The setpoint temperature of the selected indoor unit displays. Display range: 00-99°F/°C. If the temperature is higher than 99°F/°C, "99°F/°C" displays.

Fan speed. The fan speed of the selected indoor unit displays. Each bar represents an increase in speed.

Mode. The operation mode of the selected indoor unit displays.

Touchpad lock. This icon flashes fast (0.5Hz) when the centralized controller touchpad is locked.

Remote controller lock. This icon displays when the selected indoor unit's local controller is locked. The icon displays if all of the connected indoor units are in remote controller locking. The icon displays on the global settings screen if any one of the indoor units is in remote control locking.

Heating mode lock. This icon displays when the centralized controller is locked in the heating mode.

Cooling mode locking. This icon displays when the centralized controller is locked in the cooling mode.

Indoor unit address display. The address of the selected indoor unit is displayed in the grid. The display range is 00-63 to indicate 64 indoor units.

The grid is composed of 4*16 boxes; each box is composed of 2 blocks of different sizes.

The grid includes horizontal coordinates 00-15 and vertical coordinates 00+, 16+, 32+, and 48+, which determine the address of the indoor unit. The sum of the horizontal coordinate and the vertical coordinate of the grid is the address of the grid. Each grid is one indoor unit. The indoor unit location in the grid has no relation to the actual location of the indoor unit.

The grid identifies the address of the connected indoor units, by assigning each indoor unit a coordinate, for example, (00+,03) or (48+,11). The indoor unit's address is the sum of the coordinates, for example, the indoor unit at coordinates 00+03=03 address is 03, the indoor unit at coordinates 48+11=59 address is 59.

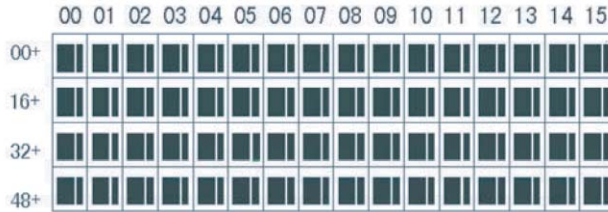

The grid displays the selected indoor unit's operation status as shown in the following table.

Status/Object	Constantly On	Slow blink	Fast blink	Dim (not lit)
Big block	Connected	Selected	---	Out of service
Small block	Power on	---	Error	Power Off

Main Display Screen Explained

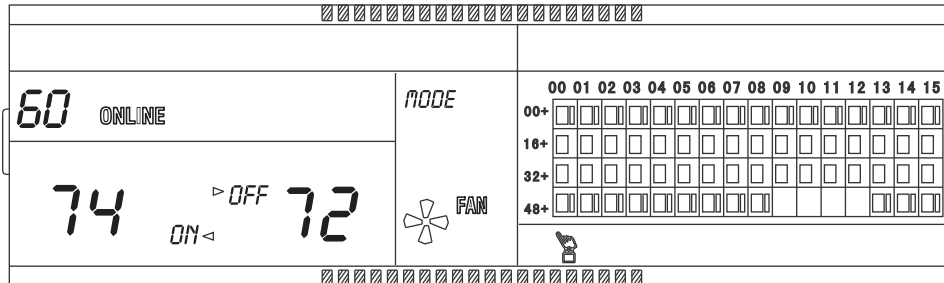

In the previous example:

- 60 indoor units are in service, 28 are on, 32 are off.
- In the grid, the big blocks from (16+,00) to (32+,15) are lit, and the small blocks are dim. This means that the 32 indoor units with addresses from 16 to 47 are turned off.
- In the grid, the big and small blocks from (48+,09) to (48+,12) are not lit. This means that the four indoor units with addresses from 57 to 60 are not connected.
- All other big and small blocks in the grid are lit, that means all other indoor units are turned on.
- The Touchpad icon displays, that means the centralized controller's touchpad is locked.

Query Screen

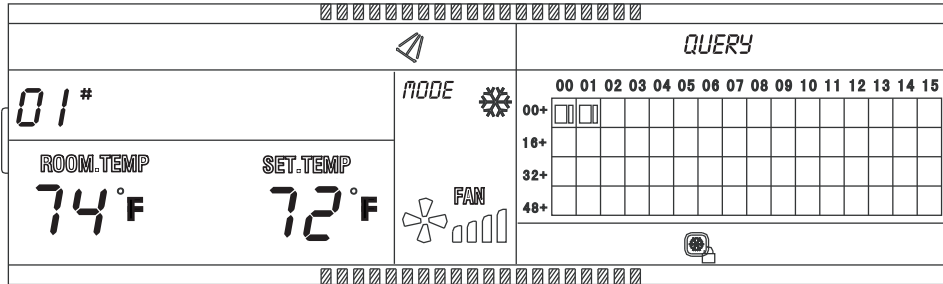

In the example above:

- The indoor unit with the address 01 is being queried.
- The indoor unit is in Cooling mode.
- In the grid, only the big and small block at (00+,00) and (00+,01) are lit. This means the indoor units with the addresses of 00 and 01 are connected and turned on.

Setting Screen

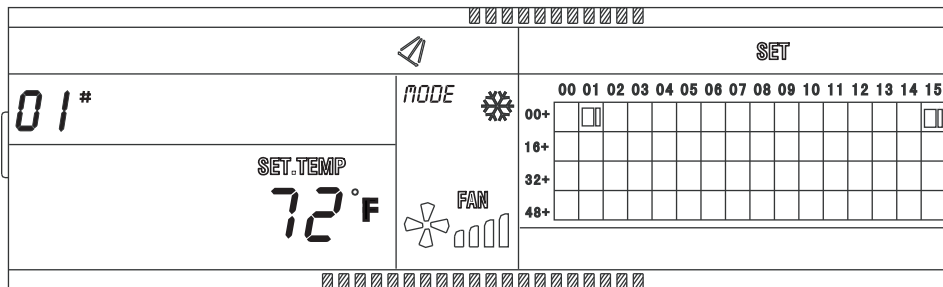

In the previous example:

- The indoor unit with the address 01 is selected.
- The indoor unit is in Cooling mode, Fan speed High, swing on, setpoint is 72°F.
- In the grid, only the big and small block at (00+,01) and (00+,15) are lit. This means the indoor units with the addresses of 01 and 15 are connected and turned on.

Fault Screen

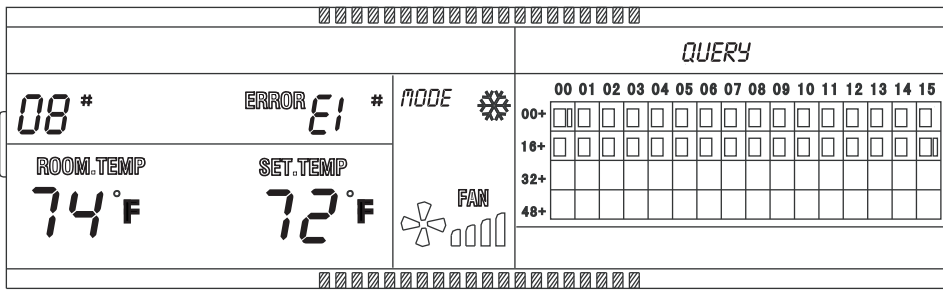

In the example above:

- The indoor unit with the address 08 is selected.
- The indoor unit with the address 08 has an error. The fault code is E1.
- In the grid, the big box at (00+,08) blinks.
- In the grid, only the indoor units at (00+,00) and (16+,15) are lit. This means that only those indoor units with the addresses 00 and 31 are connected and turned on.

Other Specifications

DIP switch operation

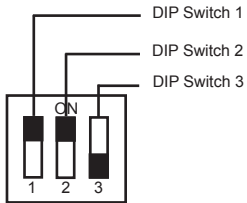

	ON	OFF
DIP switch 1	3-pipe (factory default setting)	2-pipe
DIP switch 2	Fahrenheit (factory default setting)	Celsius
DIP switch 3	Filter reminder on	Filter reminder off (factory default setting)

Filter reminder operation

- The centralized controller will remind the user to clean the selected indoor unit's filter based on the indoor unit run time hours. Setup instructions follow.
- The centralized controller will display 88 when the determined run time hours are met. 88 is the filter reminder function code.
- Clear the code by pressing and holding the Swing button and pressing the Query button at the same time.

Setup filter reminder

1. Set DIP switch 3 to "ON" and power on centralized controller.
2. Wait 1 minute, press and hold the Query button and the Fan button at the same time to enter optional function setting mode. 88 displays and flashes medium (1Hz).

3. Use the INC and DEC buttons to select the appropriate function, shown in the table below. Press the OK button. Default is 00.

Function code	Function setting
00	Filter reminder off
01	Filter reminder on

4. Use the INC and DEC buttons to select the code for the number of run time hours. See table for codes. Press the OK button.

Parameter code	Time (hours)
00	0
01	1250
02	2500
03	5000
04	10000

5. The LCD display will show 88 and “setting successfully”. After 3 seconds the Main display screen will display.

Troubleshooting

Fault Codes (Indoor Unit)

EF	Other fault
EE	Condensate pump malfunction
ED	Reserved
EC	Change/Clean filter reminder
EB	Inverter module protection
EA	Overcurrent of compressor (4 times)
E9	Communication error between main board and display board
E8	Fan speed detection out of control
E7	Indoor unit EEPROM failure
E6	Zero crossing detection error
E5	Outdoor unit fault protection
E4	T2B sensor malfunction
E3	T2A sensor malfunction
E2	T1 sensor malfunction
E1	Indoor unit and outdoor unit communication failure
E0	Phase sequence error or phase loss
07#	
06#	
05#	
04#	
03#	Not used
02#	Not used
01#	Not used
00#	Not used

Protection Codes

PF	Other protection
PE	Reserved
PD	Reserved
PC	Reserved
PB	Reserved
PA	Reserved
P9	Reserved
P8	Overcurrent of compressor
P7	Power supply over-voltage and under-voltage protection
P6	Low discharge pressure protection
P5	High discharge pressure protection
P4	Discharge temperature protection
P3	Compressor temperature protection
P2	Condenser high-temperature protection
P1	Anti-cool air or defrost protection
P0	Evaporator temperature protection