



## Installation and Setup Guide

Color Touchscreen  
Programmable Thermostat

**ComfortSense® 7500**

Model: 13H14  
507504-01  
10/2015  
Supersedes 8/2015



## IMPORTANT

Read this manual before programming the thermostat.

Use this thermostat only as described in this manual.

## TABLE OF CONTENTS

Shipping and Packing List .....	2
Overview .....	3
Installation .....	5
System Settings .....	21
Humidify .....	37
Dehumidify .....	38
Unit Part (Catalog) & Serial Numbers .....	42
Memory Protection .....	42

## Shipping and Packing List

- 1 - ComfortSense® 7500 , 7-day programmable touchscreen thermostat with back plate
- 2 - Mounting screws (M3.5x25mm self-tapping screws)
- 2 - Wall anchors
- 1 - Wall plate
- 1 - Warranty certificate
- 1 each - Homeowner and Installer Guides

*NOTE - This thermostat is equipped with automatic compressor protection to prevent potential damage due to short cycling or extended power outages. The short-cycle protection provides a 5-minute delay between heating or cooling cycles to prevent the compressor from being damaged.*

## Overview

### Description

The ComfortSense® 7500 thermostat is an electronic 7-day universal multi-stage programmable touch screen thermostat. It also offers enhanced capabilities which include:

- humidification measurement and control,
- dew point adjustment control,
- dehumidification measurement and control,
- Humiditrol® Enhanced Dehumidification Accessory (EDA) capability,
- equipment maintenance reminders,
- worry-free memory storage feature,
- menu-driven touch-screen display.

This thermostat supports heat pump or non-heat pump units, with up to two stage heat pump and two auxiliary stages or two stages of heating and two stages of cooling.

### **Dimensions (H x W x D)**

Case dimensions: 3-5/16 x 4-5/16 x 7/8 in. (84 x 110 x 22mm)

### **Wall Plate Dimensions (H x W)**

Plate dimensions: 4-1/2" x 5-3/4" (114 x 146mm)

## **Features**

### **Compressor Short-Cycle Protection**

A 5-minute compressor short-cycle protection timer begins when a compressor output is de-energized. Also, if a power loss occurs, the system will go into compressor protection mode and display "waiting" next to either a snow flake icon (compressor cooling), or flame icon (compressor heating) in the display.

### **Outdoor Sensor (Optional)**



#### **IMPORTANT**

The outdoor sensor must be connected to operate a system with a Humiditrol® accessory.

An optional (purchase separately) outdoor sensor (**X2658**) is required for dual-fuel applications, outdoor temperature display on the home screen, balance points, dew point humidity control, and with Humiditrol® EDA.

In addition to measuring and displaying outdoor temperature, the outdoor sensor provides dew

point adjustment and control for all models. If used with this thermostat, the sensor enables optimal heating equipment operation via programmable balance points.

*NOTE - For proper operation of Humiditrol® EDA applications, the outdoor sensor (X2658) MUST be installed.*

Refer to page 11 for remote sensor installation and thermostat setting configuration.



**Figure 1. Outdoor Sensor**



## **IMPORTANT**

In all applications, the ComfortSense® Model 7500 thermostat can only be used with all residential units and approved commercial split-system matches, and those which meet the following installation criteria:

- installation uses 18 GAUGE thermostat wire or larger,
- thermostat wire run length DOES NOT EXCEED 300' (91m),
- load from any thermostat connection is 1 AMP or LESS.



### WARNING

Improper installation, adjustment, alteration, service or maintenance can cause property damage, personal injury or loss of life.

Installation and service must be performed by a licensed professional HVAC installer (or equivalent) or service agency.



### CAUTION

This is a 24VAC low-voltage thermostat. Do not install on voltages higher than 30VAC.

Do not short (jumper) across terminals on the gas valve or at the system control to test installation. This will damage the thermostat and void the warranty.



### CAUTION

Always turn off power at the main power source by switching the circuit breaker to the OFF position before installing or removing this thermostat.

All wiring must conform to local and national building and electrical codes and ordinances.

### Installation

Before beginning installation, note the type of equipment, number of stages, and any accessories being installed. This thermostat is a 24VAC low-voltage thermostat and requires a common wire to the thermostat to operate.

#### DO

- Shut off all power to system before installing.
- Read this entire document, noting which instructions pertain to your equipment and system requirements.
- Make sure that all wiring conforms to local and national building and electrical codes and ordinances.

- Use thermostat wire between the thermostat and the optional outdoor temperature sensor (may be separate wire pair or two wires of a multi-wire cable).
- Ensure load from any thermostat connection is less than 1 AMP.

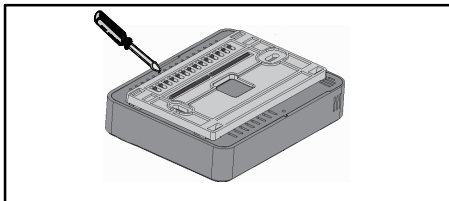
### **DO NOT**

- Install on voltages higher than 30VAC.
- Short (jumper) across terminals on the gas valve or at the system control to test installation. This will damage the thermostat and void the warranty.
- Install on outside walls or in direct sunlight.
- Exceed thermostat wire run length greater than 300 feet (91m).

### **INSTALLING THERMOSTAT**

1. Unpacked the thermostat and open the case with a thin-blade screwdriver. Place between wall base and unit and twist to separate unit from base.
2. Select a location for the thermostat about 5 feet (1.5m) above the floor in an area with good air circulation at average temperature.
3. Do not install the thermostat where it can be affected by:
  - Drafts or dead spots behind doors and in corners.
  - Not close to entrance or automatic doors
  - Not close to heat generating equipment such as kitchen equipment
  - Not in an enclosed environment unless a remote indoor sensor is used.
  - Hot or cold air from ducts.

- Radiant heat from sun or appliances.
- Concealed pipes and chimneys.
- Non-heated (non-cooled) areas such as an outside wall behind the thermostat.

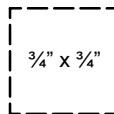


**Figure 2. Removing Back Plate**

4. Use steps **A** through **J** (step **J** applicable when using provided wall plate) to install the thermostat.

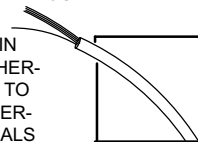
CUT OR DRILL A SMALL HOLE  
FOR THERMOSTAT WIRING

**A**



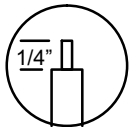
PULL ABOUT 3" OF THERMOSTAT  
WIRE THROUGH OPENING AND RE-  
MOVE OUTER THERMOSTAT WIRE  
JACKET.

THIS WILL HELP IN  
ROUTING THE THER-  
MOSTAT WIRING TO  
THE PROPER THER-  
MOSTAT TERMINALS



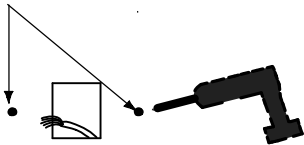
**B**

- C** TRIM 1/4" INSULATION FROM  
END OF EACH WIRE

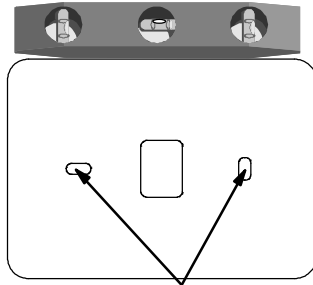


DRILL 3/16" HOLES AT MARKED LOCATIONS  
ON WALL FOR ANCHORS

**E**



(USE A LEVEL) ALIGN WALL PLATE



USE UNIT WALL PLATE AS TEMPLATE TO MARK  
DESIRED MOUNTING HOLE LOCATIONS ON WALL.

NOTE: INSTALLATION OF WALL PLATE IS  
OPTIONAL.

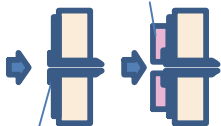


## Thermostat Installation with Wall Plate

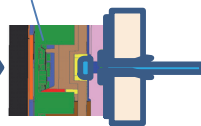
**F** - Place wall plate over holes in wall.



**H** - Attach back plate to wall plate.



**J** - Attach thermostat to back plate.

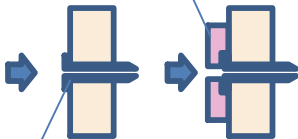


**G** - Insert wall anchors through wall plate into wall.

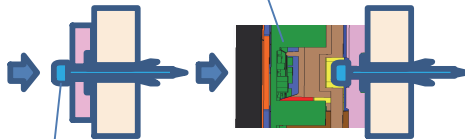
**I** - Insert provided screws through back and wall plates into wall anchors.

## Thermostat Installation without Wall Plate

**G** - Place back plate over wall anchors in wall.



**I** - Attach thermostat to back plate.



**F** - Insert wall anchors through wall plate into wall.

**H** - Insert provided screws through back plate into wall anchors.

## **WIRING THERMOSTAT**

Thermostat wiring connections with various units, including dual fuel, zone control, and applications that include the Humiditrol® Enhanced Dehumidification Accessory (EDA). See figures 3 through 7. For whole home dehumidifier, refer to the installation instruction for the dehumidifier.

1. Connect wiring between thermostat, indoor unit, and outdoor unit as shown in the appropriate wiring diagram.
2. Connect optional (purchase separately) outdoor sensor. *See Installing Outdoor Sensor for further details and provided wiring diagrams.*
3. Seal the hole in the wall with a suitable material to prevent drafts from entering the thermostat case.
4. Configure thermostat and equipment for system type, program the thermostat, and test system.

## **TERMINAL DESIGNATIONS**

- Tc - Outdoor Temp. Sensor Connection 1
- To - Outdoor Temp. Sensor Connection 2
- H - Humidification relay (to Humidifier)
- D - Dehumidification relay (to DS terminal)
- W2 - Second-stage heating (non-heat pump) or 4th stage (heat pump)
- Y2 - Second-stage heating or cooling
- O - Cool active reversing valve
- B - Heat active reversing valve
- C - Common 24VAC
- G - Fan relay
- W1 - First-stage heating (non-heat pump or emergency heat) or third-stage heating (heat pump)
- Y1 - First-stage heating or cooling
- R - 24VAC power

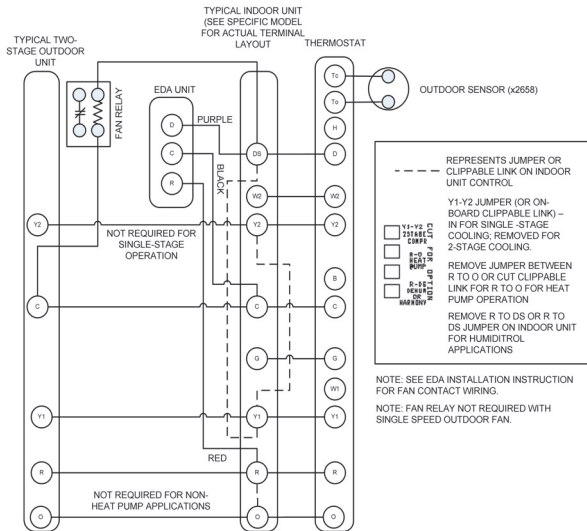
### **Installing Outdoor Sensor**

Install the optional (purchase separately) outdoor sensor on a northern wall of the home, away from direct sunlight or other heat sources that may affect its sensitivity.

*NOTE - The outdoor sensor uses standard thermostat wiring; it may be wired using two wires*

*of a multi-wire cable with a wire run not to exceed 300 feet or 100 meters.*

1. Connect outdoor sensor to terminals **Tc** and **To** on thermostat.
2. Outdoor sensor also has to be enabled under **menu > settings > outdoor sensor = yes or no.**

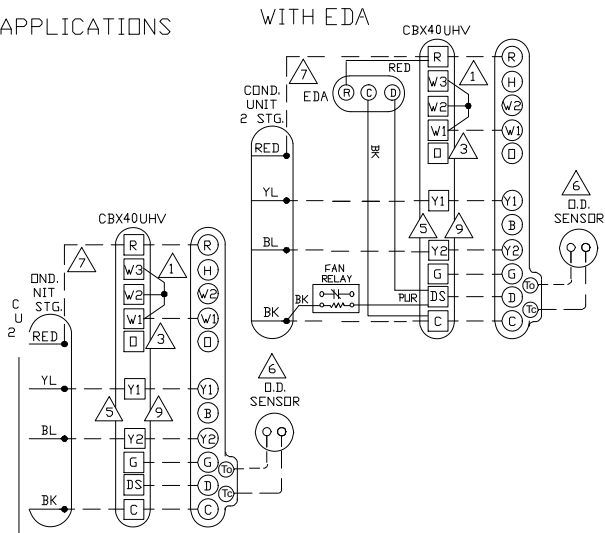


**Figure 3. Enhanced Dehumidification Accessory Typical Wiring Diagram**

## CONDENSING UNIT APPLICATIONS

- △1 WHEN 2-STAGE HEAT IS USED, T'STAT IS CONFIGURED FOR MULTI-STAGE HEAT. CONNECT T'STAT W2 TO AIR HANDLER W2 & REMOVE JUMPER BETWEEN W1 & W2.
- △3 DO NOT CUT ON-BOARD LINK FROM R TO D. IT IS USED FOR CONDENSING UNIT APPLICATIONS.
- △4 CUT ON-BOARD LINK FROM R TO D ON AIR HANDLER.
- △5 CUT ON-BOARD LINK FROM R TO DS WHEN DEHUMIDIFICATION D TERMINAL IS USED.
- △6 OUTDOOR SENSOR FOR OUTDOOR TEMP. DISPLAY, OPTIONAL HUMIDIFIER DEW POINT CONTROL, HEAT PUMP BALANCE POINTS & DUAL FUEL BALANCE POINTS.
- △7 RED WIRE TO OUTDOOR CONDENSING UNIT USED ONLY FOR UNITS WITH LSDM.
- △9 FOR 2-STAGE CUT ON-BOARD LINK FROM Y1 TO Y2 ON AIR HANDLER.

NOTE: NOT ALL UNUSED TERMINALS ARE SHOWN ON T'STAT DIAGRAMS.

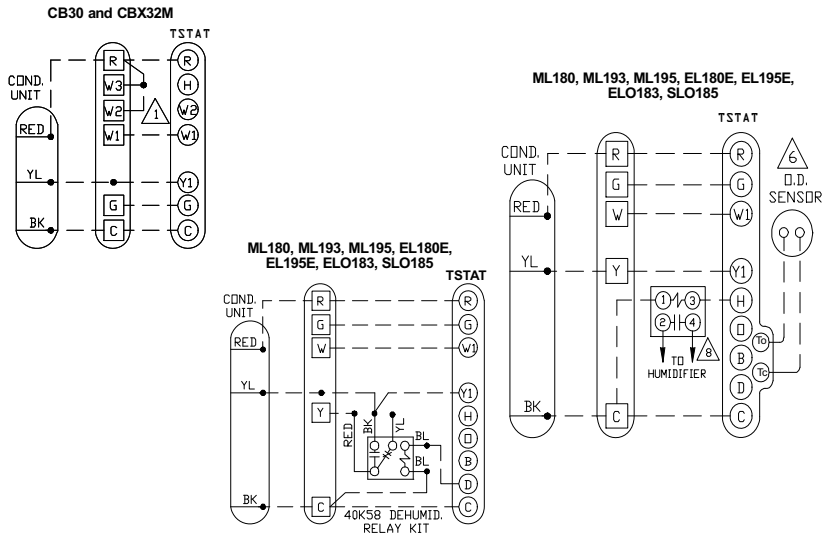


**Figure 4. CBX32MV-XXX-230-06 or Higher and CBX40UHV Wiring Diagrams (Condensing Unit Applications)**



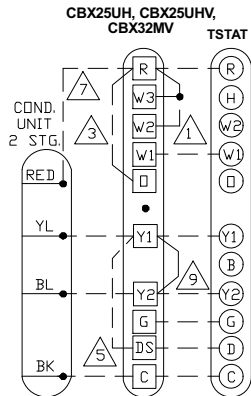
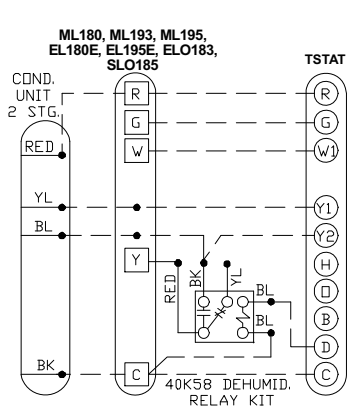
1	WHEN 2-STAGE HEAT IS USED, THERMOSTAT IS CONFIGURED FOR MULT-STAGE HEAT, CONNECT THERMOSTAT W2 TO AIR HANDLER W2 AND REMOVE JUMPER BETWEEN R AND W2.	7	CBX25UH AND CBX25UHV DO NOT HAVE TERMINAL STRIPS IN UNIT.
2	CUT ON-BOARD LINK FROM DS-TO-R (W914 CLIPPABLE CONNECTION ON FURNACE / JUMPER ON AIR HANDLER) WHEN DEHUMIDIFICATION OR HARMONY CONTROL IS USED.	8	FOR HUMIDIFIER, 48G95 OR EQUIVALENT ISOLATION RELAY REQUIRED - 24VAC, 5VA MAX CAN BE USED WITH ALL THERMOSTAT APPLICATIONS.
3	DO NOT CUT -ON-BOARD LINK FROM R-TO-O (W951 CLIPPABLE CONNECTION ON FURNACE / JUMPER ON AIR HANDLER) WHEN IT IS USED FOR CONDENSING UNIT APPLICATIONS.	9	FOR 2-STAGE CUT ON-BOARD LINK FROM Y1-TO-Y2 (W915 CLIPPABLE CONNECTION ON FURNACE / JUMPER ON AIR HANDLER).
4	CUT ON-BOARD LINK FROM R-TO-O (W951 CLIPPABLE CONNECTION ON FURNACE / JUMPER ON AIR HANDLER).	10	K183 DEHUMIDIFICATION RELAY KIT (26W62) REQUIRED WHEN USING D-TO-DS TERMINALS WITH CBX27 UNITS.
5	REMOVE DS-TO-Y1 JUMPER WHEN DEHUMIDIFICATION D TERMINAL IS USED.		NOTE: NOT ALL UNUSED TERMINALS ARE SHOWN ON THE THERMOSTAT DIAGRAMS.
6	OUTDOOR SENSOR FOR OUTDOOR TEMP DISPLAY, OPTIONAL HUMIDIFIER DEW POINT CONTROL, HEAT PUMP BALANCE POINTS AND DUAL-FUEL BALANCE POINTS.		

**Figure 6. Key for Figures 7 through 11.**

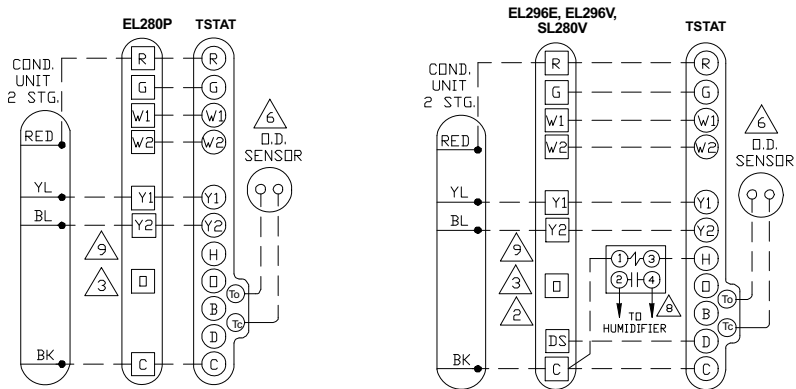


**Figure 7. Thermostat Wiring Diagrams (continued)**

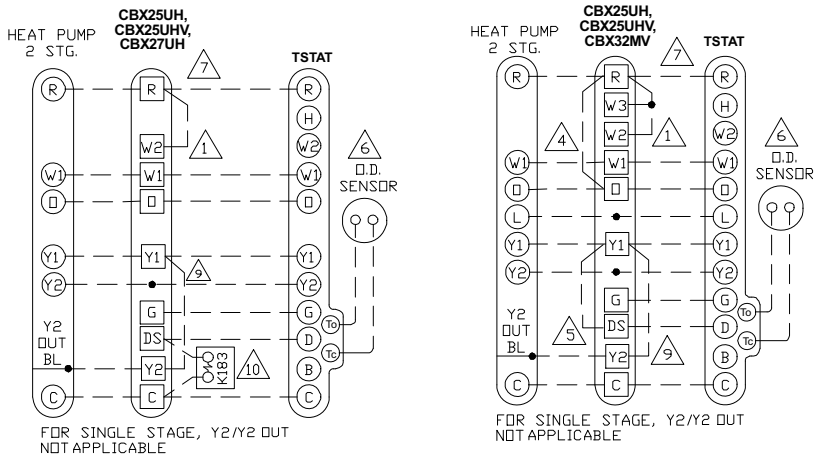




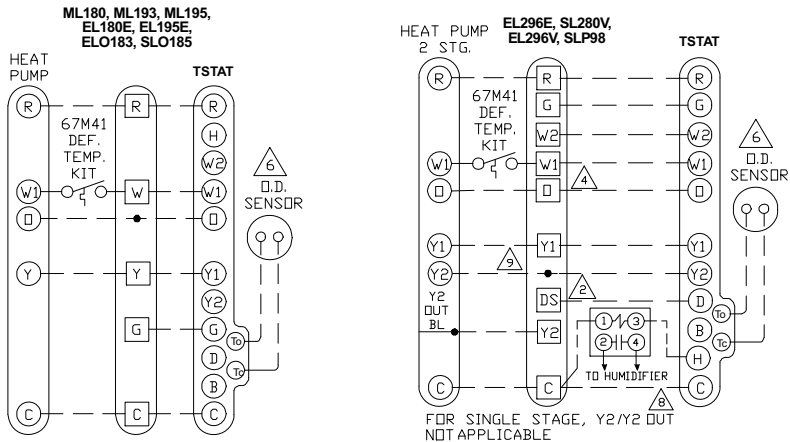
**Figure 8. Thermostat Wiring Diagrams (continued)**



**Figure 9. Thermostat Wiring Diagrams (continued)**



**Figure 10. Thermostat Wiring Diagrams (continued)**



**Figure 11. Thermostat Wiring Diagrams (continued)**

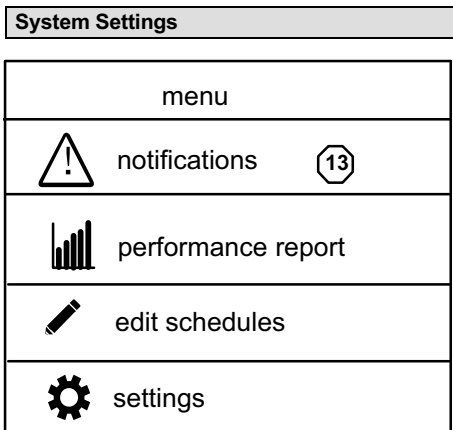


Figure 12. Menu Screen

## MENU

1. Touch **menu** option from the home screen.
2. Touch and hold the **settings** option on the menu. This will display the **installer settings** notice and then menu.

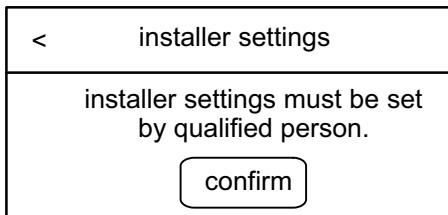


Figure 13. Installer Menu Screen Confirmation

## **SYSTEM SETUP**

Sets the thermostat for operation with either a non-heat pump or heat pump and defines the number of compressor stages. Indoor unit settings include no heat, gas/oil or electric and number of indoor heat stages.

## **OUTDOOR SENSOR**

Options are **yes** or **no** (default).

## **RESIDUAL COOL**

Default is 0 seconds. This is the time, in seconds, that the fan runs after a call for cooling is satisfied in order to deliver any residual cooling ability from the coil and ductwork into the conditioned space. Options are 0, 30, 60, 90 and 120 seconds. **Touch <** to return to previous menu.

## **LOW AND HIGH BALANCE POINTS**

These balance points are for heat pump systems only with an outdoor sensor installed and enabled plus a indoor unit setting enable. Either gas/oil or electric will enable the balance point options in the installer settings list.

1. When in heat mode and the outdoor temperature is below the programmed Low

Balance Point, then heat pump heating is not allowed and only backup heat will be used.

2. When in heat mode and the outdoor temperature is above the programmed High Balance Point, then heat pump heating is allowed and backup heat will not be used.
3. When in heat mode and the outdoor temperature is between the programmed Low and High Balance Points, then heat pump heating and backup heat can be used.
4. Options are enable or disable. Default for both is disable. Once enabled, the following settings are available.
5. Low Balance Point Default is 25°F. Adjustable range is -40°F to 48°F.
6. High Balance Point Default is 50°F. Adjustable range is -38°F to 75°F.

**NOTE** - *The high balance point minimum range is adjustable to within +2°F of the low balance point setting. For example, if the low balance point is set to 0°F, then the lowest setting for the high balance point is 2°F.*

**Table 1. Smooth Set back Recovery (SSR) & SSR Stg 2 Lock Out Operation**

Equipment Available	SSR = Enabled; SSR Stg 2 lock out = enabled	SSR = Enabled; SSR Stg 2 lock-out = disabled (off)
1 stage HP with 1 or 2 stages electric backup	Run HP (Y1) only; all backup heat (W1/W2) enabled 20 - 120 min before wake up setpoint	Run HP (Y1) and have available backup heat (W1/W2) as needed.
2 stage HP with 1 or 2 stages electric backup	Run HP (Y1/Y2) only; all backup heat (W1/W2) enabled 20 - 120 min before wake up setpoint	Run HP (Y1/Y2) and have available backup heat (W1/W2) as needed.
1 stage HP with 1 stage gas/oil backup	Run HP (Y1) only; all backup heat (W1) enabled 20 - 120 min before wake up setpoint	Run HP (Y1) until a 2nd stage demand is needed (by time/temp. differential); then HP operation must stop and changeover and lock in to W1 heat until setpoint reached.
1 stage HP with 2 stages gas/oil backup or modulation furnace	Run HP (Y1) only; all backup heat (W1/W2) enabled 20 - 120 min before wake up setpoint	Run HP (Y1) until a 2nd stage demand is needed (by time/temp differential); then HP operation must stop and changeover to W1/W2 heat as needed; lock in W1/W2 heat until setpoint reached.

**Table 1. Smooth Set back Recovery (SSR) & SSR Stage 2 Lock Out Operation (continued)**

<b>Equipment Available</b>	<b>SSR = Enabled; SSR Stage 2 lock out = enabled</b>	<b>SSR = Enabled; SSR Stage 2 lock-out = disabled (off)</b>
2 stage HP with 1 stage gas/oil backup	Run HP (Y1/Y2) only; all backup heat (W1/W2) enabled 20 - 120 min before wake up setpoint	Run HP (Y1/Y2) until a 2nd stage demand is needed (by time/temp. differential); then HP operation must stop & changeover and lock in to W1 heat until setpoint reached
2 stage HP with 2 stages gas/oil backup or modulation furnace	Run HP (Y1/Y2), all backup heat (W1/W2) enabled 20 - 120 min before wake up setpoint	Run HP (Y1/Y2) until a 2nd stage demand is needed (by time/temp. differential); then HP operation must stop & changeover and lock in to W1/W2 heat until setpoint reached.
2 stages gas/oil heat or modulation furnace	Run W1 only; W2 enabled 20 - 120 min before wake up setpoint	Run W1 heat and bring on W2 heat until setpoint reached.
1 stage cooling	Run Y1 to wake up set point	Run Y1 heat until setpoint reached.
2 stage cooling	Run Y1 during recovery enable Y2 field wake up set point	Run Y1 & Y2 heat as needed until setpoint reached.



## **DEADBAND**

Default is 2°F. The deadband setting is the minimum difference between the cooling and heating set points. This setting is used in cool/heat mode to ensure smooth equipment operation. The deadband is adjustable from 2 to 9°F. Use the + or - option to select desired deadband. **Touch <** to return to previous menu.

## **SMOOTH SET RECOVERY(SSR)**

Options are enable or disable. Default is enable. When enabled, smooth set back begins recovery up to two hours before the programmed time so that the programmed temperature is reached at the corresponding programmed event time. Assume 12°F per hour for first stage gas/electric heating and 6°F per hour for first stage compressor based heating or cooling. With Smooth Set Back disabled, the control will start a recovery at the programmed time.

*NOTE - Smooth Set Back and Stage2 Lock Out operations vary depending on equipment (see table 1).*

## **SSR STAGE 2 LOCK OUT**

Default is 20 minutes. Use the + or - option to set the number of minutes before the programmed event time that stage 2 is allowed to operate (20 to 120 minutes in 10 minute increments). Touch < to return to previous menu.

## **DEALER INFORMATION**

This allows the installer to add dealer name, address, phone, email, website and number.

Touch < to return to previous menu.

## **TEMPERATURE OFFSET**

Default is 0°F. This setting can be used to offset the displayed space temperature by up to +/- 5°F. This offset also applies to the control temperature. Touch < to return to previous menu.

## **HUMIDITY OFFSET**

Default is 0%. This can be used to offset the displayed and controlled space relative humidity (RH) by up to +/- 10% RH. Touch < to return to previous menu.

### **STAGE DELAY TIMER**

Default is ON. When ON, all stage delay timers (stages 2, 3, and 4) are enabled and will serve to bring on additional stage(s) of cooling or heating on a timed basis (default 20 minutes) in cases when the previous stage of heating or cooling will not raise or lower the room temperature to the set point in a given time.

When OFF is selected all stage delay timers are disabled. This means stages are changed based on the temperature and not their timer delays. Scroll to STG DELAY TIMERS; and touch to select the applicable stage delay timer. Touch < to return to previous menu.

### **STAGE DELAY DIFFERENTIALS**

Stage delays and differentials are individual set in the installer settings screen.

### **STAGE 1 DIFF**

Stage 1 differential is used in all thermostats. The default is 1.0°F but can be programmed between 0.5° and 8.0°F in 0.5°F increments. Touch < to return to previous menu.

### **STAGE 2 THROUGH 4 DIFF**

(Where applicable) The default is 1.0°F but can be programmed between 0.5° and 8.0°F in 0.5°F increments. Touch < to return to previous menu.

### **STAGE 2 THROUGH 4 DELAY**

(Where applicable) If STAGE DELAY TIMERS is turned ON, the default delay is 20 minutes but can be programmed from 5 to 120 minutes in 5-minute increments. If first stage fails to advance the ambient temperature toward the setpoint by 1.0°F in the programmed delay time, then the second stage is activated.

Scroll to STAGE 2 DELAY (or 3 or 4); Touch to select. Select the desired delay. Touch < to return to previous menu.

### **H/C STAGES LOCKED IN**

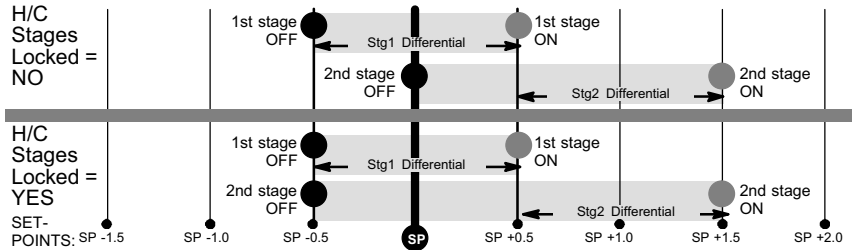
Default is enabled. When set to disabled heat/cool stages are turned off separately). If set to enabled, heat/cool stages are turned off together. Touch < to return to previous menu.

## **STAGE 2 HP LOCK TEMP**

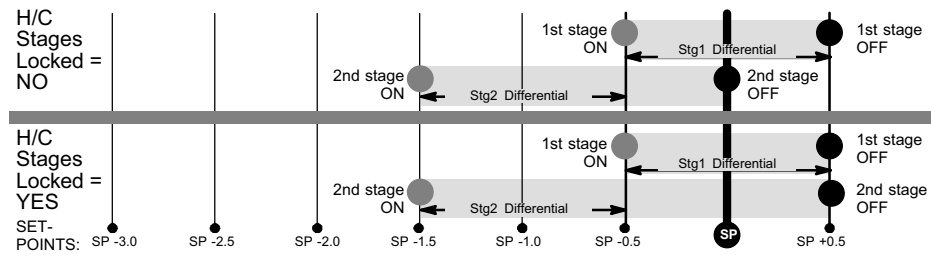
Default is off (heat pump stage 2 operates normally). Use this setting in dual fuel applications to lock in the 2nd stage compressor when the outdoor temperature is at or less than the LOCK

TEMP set point. Scroll to STAGE 2 HP LOCK TEMP; touch **ENTER**. Use - + option to select a LOCK TEMP between -40 and 75°F. Touch < to return to previous menu.

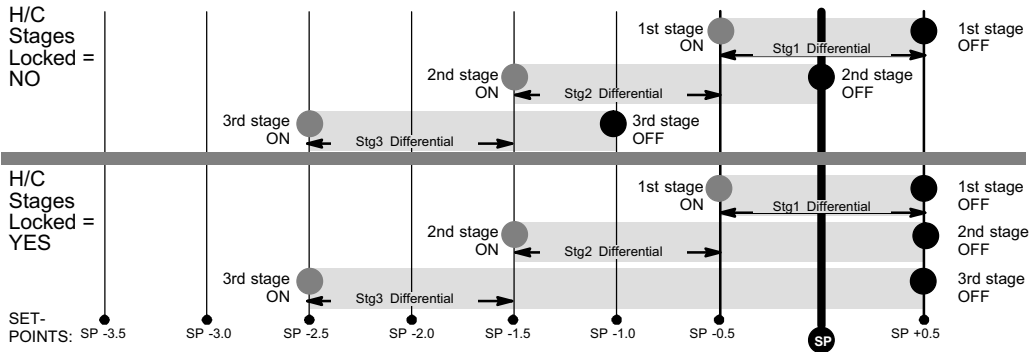
<b>Configuration</b>	<b>Figures</b>
Multi-stage Cooling for Heat Pump/Non-Heat Pump	14
Heating - Non-Heat Pump (1 or 2 stages)	15
Heating - Heat Pump with NO backup heat	10
Heating - Heat Pump w/electric heat (2-stage: 1compr/1backup)	10
Heating - Heat Pump w/electric heat (3 stage: 2compr/1backup)	11
Heating - Heat Pump w/electric heat (3 stage: 1compr/2backup)	11
Heating - Heat Pump w/electric heat (4 stage: 2compr/2backup)	12
Heating - dual fuel (2-stage: 1compr/1backup)	13
Heating - dual fuel (3 stage: 1compr/2backup)	14
Heating - dual fuel (3 stage: 2compr/1backup)	15
Heating - dual fuel (4 stage: 2compr/2backup)	16



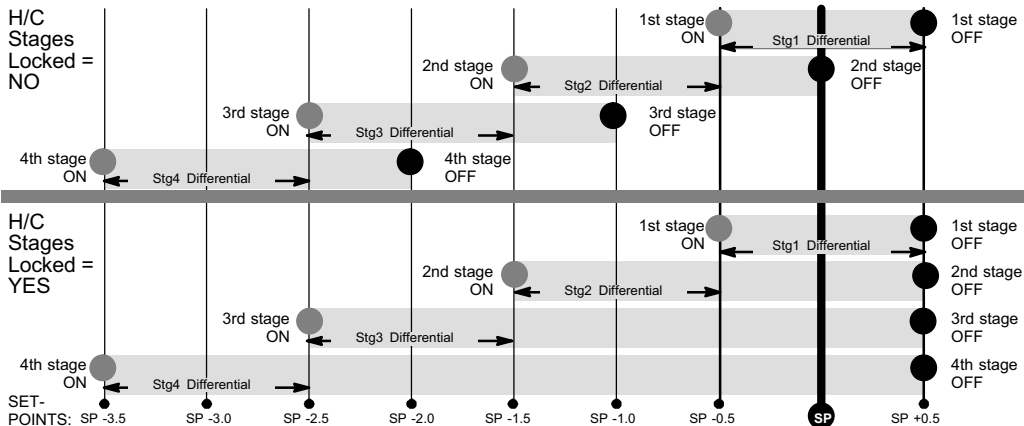
**Figure 14. Cooling - 1 or 2 stages**



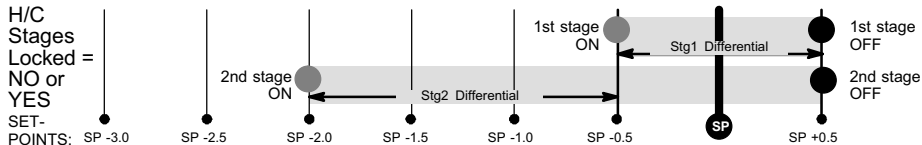
**Figure 15. Heating - Non-Heat Pump or Heat Pump w/o backup heat - 1 or 2 stages**



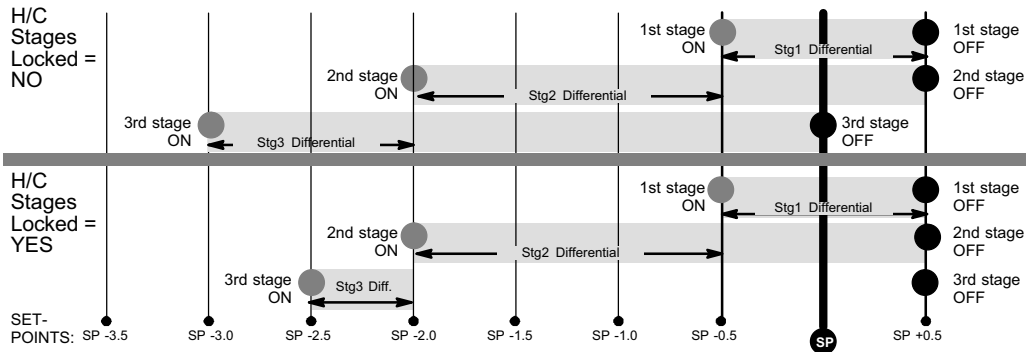
**Figure 16. Heating - Heat Pump w/electric - 3 stage (2 compressor / 1 backup OR 1 compressor / 2 backup)**



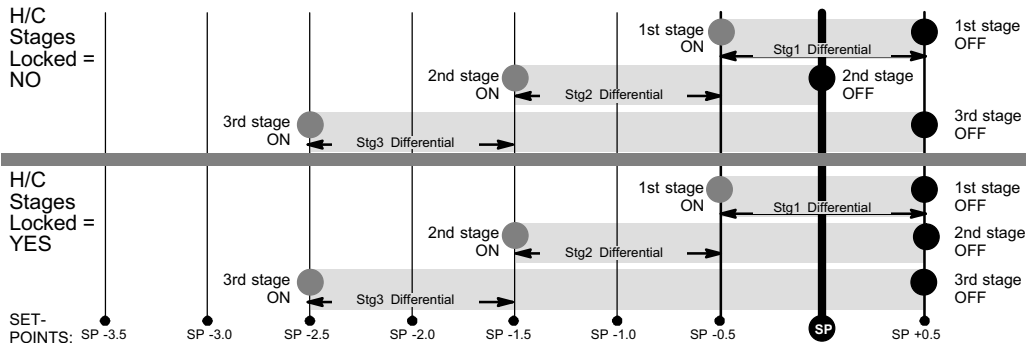
**Figure 17. Heating - Heat Pump w/electric - 4 stage (2 compressor / 2 backup)**



**Figure 18. Heating - dual fuel - 2 stage (1 compressor / 1 backup)**

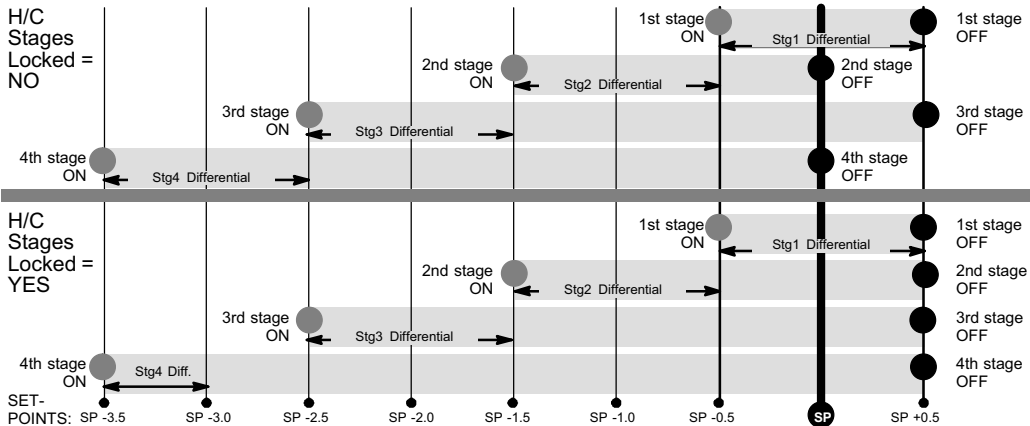


**Figure 19. Heating - dual fuel - 3 stage (1 compressor / 2 backup)**



**Figure 20. Heating - dual fuel - 3 stage (2 compressor / 1 backup)**





**Figure 21. Heating - dual fuel - 4 stage (2 compressor / 2 backup)**

## COMPRESSOR PROTECT

Default is ON and it can be turned OFF, however only for one compressor cycle and then it will revert back to ON.

If the system is running in compressor protection, the home screen displays "WAITING" only if there is cooling or heating call for the compressor (Y1/Y2).

If compressor protection is running and there is a demand for electric heating, the system waits for the compressor protection timer to expire.

## HUMIDITY SETTING

See separate sections - Humidity (see page 37) and Dehumidity (see page 38).

## CUSTOM REMINDER

Two custom reminders may be rename on this screen to the desired name (name is limited to 19 characters). After entering the new name, touch the done key to return to the customer reminder screen.

To set a reminder go to the User Settings screen and select **reminders**. The reminder setting screen will appear and a list all of the predefined reminders plus the two custom reminders will appear at the end of the list.

Scroll to CUSTOM REMINDER 1 or 2 (or renamed titles). Touch the title to select the reminder. By default all reminders are set to disabled. Touch disable to choose from 3mon, 6mon, 12mon, 24mon or custom date.

When finished, **touch <** to return to previous menu.

## RESET SETTINGS

To reset the thermostat to factory defaults, scroll to RESET SETTINGS and touch to select. Read the message and to continue touch **CONFIRM**.



### **IMPORTANT**

**RESET SETTINGS** erases all programming and returns the thermostat to the factory conditions, including the installer settings. Use this only as a last resort.

**Table 2. Energy Saving Set Points**

	<b>Time</b>	<b>Heating</b>	<b>Cooling</b>
NOTE - Humidification and dehumidification are not part of the energy savings program. A higher utility bill may occur when not using the setpoints in this table.	Wake	70°F (21°C)	78°F (25°C)
	Leave	62°F (17°C)	85°F (29°C)
	Return	70°F (21°C)	78°F (25°C)
	Sleep	62°F (17°C)	82°F (28°C)

### **ENERGY SAVING DEFAULT**

Energy saving recommended set points for heating and cooling can help save energy. The time and temperatures reference in table 2 are pre-programmed into the thermostat to achieve energy savings.









Scroll to ENERGY SAVING DEFAULT; touch to select. Read the message on the screen and to continue, touch **CONFIRM**.

### **SYSTEM TEST MODES**

After the thermostat has been installed and set-up, the installer may run a system test function (accessed through the installer settings menu), to test all cooling, heating, emergency heating stages and FAN outputs.

Select system test mode. A pop-up will be displayed indicating all equipment will be stopped. Touch **confirm** to continue.

Pressing the **OFF** button next to the desired option will change the status to **ON** and will enable the relay for that terminal. Pressing again will turn **OFF** the relay. Touch the left arrow (<) to exit the system test mode.

system test mode	
Y1	
Y2	
W1	
W2	
G	
H	
D	
OB	

## NOTICE

Risk of equipment damage.

Can cause compressor failure.

In dual fuel system applications, do not turn on heat pump and furnace at the same time in system test mode.

All HVAC components can be tested to confirm the signals between thermostat and unit are being sent and were received.

*NOTES: After 5 minutes without a test being initiated, the test modes is disabled and system goes back to the normal mode (i.e. HOME screen).*

*When in SYSTEM TEST MODE, the compressor minimum off timer is bypassed.*

## Humidify

Humidification (adding moisture to air) is provided only when the thermostat is in **heat mode**. The humidification signal (H terminal) to the humidifier (off when the thermostat is in the COOL mode) controls humidification. When the thermostat is powered, the H terminal is normally inactive (open circuit) in any mode (HEAT/COOL, HEAT, COOL, OFF). When a humidification demand is present, H terminal and G terminal are energized (24V).

The system must be in heat mode and had at least one heating call before humidification feature is active. Once humidification is active the humidification modes are as follows:

- **Normal:** Runs humidification with a call for heat and humidification.
- **Max:** Runs humidification with a humidification call but without a call for heating.
- **Dew Point Normal:** Runs humidification with call for heat and humidification based on outdoor temperature.

- **Dew Point Max:** Runs humidification with a humidification call but without a call for heating based on outdoor temperature.

A selection option under **Installer settings > Humidity settings > Humidify > Humidify mode** must be enabled before the user will have control over the humidity. The humidity mode selected determines how the user can adjust the relative humidity (RH). The installer settings include **NORMAL, MAX, DEW POINT NORMAL, DEW POINT MAX, and OFF.**

### **NORMAL & MAX**

These thermostat modes allow the user to control the relative humidity (RH) between 15 and 45%. The following conditions must be met for either mode to operate:

- humidification mode has been enabled, and
- the unit is in HEAT mode, and
- humidification demand exists (24V present at H)

Additionally, the **NORMAL** mode requires heat demand exists (Y energized for heat pump heating, or W energized for gas heat [W may be energized with G de-energized]).

Rh set point	=	$\frac{\text{Outdoor Temp (°F)}}{2}$	+ 25	+	RH <sub>user dew point adjustment</sub>
<b>Where:</b> RH <sub>user dew point adjustment</sub> cannot exceed +/-15% and RH <sub>setpoint</sub> minimum is 15% and cannot exceed 45%.					

### **DEW POINT NORMAL & MAX**

Dew point adjustment mode will change the humidification set point based on the outdoor temperature and a user-defined dew point adjustment setting.

*NOTE - In dew point adjustment mode, the humidification set point has no effect whatsoever on unit operation. Only the user-defined dew point adjustment setting affects operation per the following the above formula.*

### **Dehumidify**

Dehumidification (removing moisture from air) can occur only when the thermostat is in **cool mode**. When a dehumidification demand is present, a dehumidification signal (0VAC - open circuit) is present at the D terminal. This is used to reduce

the speed of the indoor blower during dehumidification. At the same time, the Y1 and Y2 (if available) terminals become activated with 24VAC. The H terminal is inactive (0VAC - open circuit) during dehumidification.

System must be in cool mode and had one call for AC before feature is active. Once dehumidification is active the dehumidification modes are as follows:

- **Normal:** Runs dehumidification with a call for cooling and dehumidification.
- **Max:** Runs dehumidification with a dehumidification call but without a call for cooling.
- **Auxiliary Dehumidifier:** Runs based on humidity reading from thermostat's internal humidity sensor and will call for dehumidification using the auxiliary dehumidifier (whole house dehumidifier).

- **Humiditrol:** Runs based on humidity reading from thermostat's internal humidity sensor, heating set point and outside temperature.

Will over cool space based on settings of min

*NOTE - The D terminal is ALWAYS activated (24VAC) when the thermostat is in HEAT or OFF mode; it is only inactive (0VAC - reverse logic) during dehumidification.*

Dehumidification adjustment will change the relative humidity (RH) setting between 45 to 60% RH (default setting is 50% RH). The lower the number, the more humidity will be removed from the air.

A selection option under **Installer settings > Humidity settings > Dehumidify > Dehumidify mode** must be enabled before the user will have control over the humidity. The mode selected determines how the user can adjust the relative humidity (RH). The installer settings include:

1. **NORMAL**
2. **MAX**
3. **AUXILIARY DEHUMIDIFIER**
4. **HUMIDITROL**

## 5. OFF

### **NORMAL**

In this mode, dehumidification occurs if these conditions are met and signals are present at specific terminals:

1. Dehumidification has been enabled on installer settings.
2. Unit is in COOL mode.
3. Dehumidification demand exists (RH above set point).
4. Cooling demand exists (Y1 energized).

### **MAX**

In this mode, dehumidification occurs if all MAX conditions are true, except cooling demand may or may not be present. Maximum over cool from cooling set point is 2°F.

## **AUXILIARY DEHUMIDIFIER**

The auxiliary dehumidifier setting is used when a whole home dehumidifier is used for dehumidification. This requires:

1. Whole home dehumidifier has been wired to thermostat per dehumidifier installation instructions.
2. Dehumidification has been enabled on installer settings.
3. Unit is in COOL mode, (or if in AUTO, there has been at least one thermostat cooling call made prior to the dehumidification demand).
4. Dehumidification demand exists (RH above set point).

## **HUMIDITROL®**

If Humiditrol is enabled in the installer settings, then this adjustment affects overcooling operation. Overcooling ranges from 2°F below the cooling setpoint (**MIN** setting) down to 2°F above the heating setpoint (**MAX** setting). Halfway between the two settings is the **MID** setting.

If a Humiditrol® EDA is installed and enabled, then the thermostat must be configured to properly operate the Humiditrol® EDA as follows (see Figure 22 for the Humiditrol® EDA operation flowchart):

Check the HUMIDITY SETTINGS in user settings to confirm that the user has turned **ON** dehumidification setting.

*NOTE - Humiditrol® EDA operation requires use of an outdoor sensor. If sensor is not connected and Humiditrol® EDA is enabled, "OUTDOOR SENSOR REQUIRED" is displayed in the information display.*

**Cooling only**—Dehumidification will only occur if:

1. Dehumidification demand is present.
2. Cooling demand is not present.
3. Outdoor temperature is less than 95°F,
4. Indoor temperature is not cooler than 65°F or cooler than the heating set point + 2°F (**IF** the difference between cooling and heating set points is greater than the deadband).



In this case, 24VAC is removed from the **D** terminal and **Y1** and **Y2** terminal (if available) becomes activated with 24VAC. This cycles the indoor variable speed motor to the dehumidification speed and cycle Y2 **ON** to the outdoor unit. Cooling has priority over Humiditrol® calls. Humiditrol® mode is allowed to over cool up to 2°F above the heating set point.

**Heat only**—*Thermostat will cycle heating ON and OFF to maintain heating set point. Dehumidification functions are disabled.*

**Heat/Cool**—*Dehumidification will only occur if a dehumidification demand is present, a cooling demand is not present, outdoor temperature is less than 95°F, indoor temperature is above 65°F and the indoor temperature is not cooler than 2°F above heating set point.*

*Note: If the last thermostat demand was a heating demand, the thermostat does not require a cooling demand before Humiditrol® operation.*

## **Humidity Sensor Fault**

If the humidification sensor fault occurs, then the **H** terminal becomes inactive, and the **D** terminal goes to 24VAC.

*Dew point adjust is only available when an outdoor sensor is attached.*

## **Other Humiditrol® EDA Notes**

*If the outdoor sensor is disconnected while HUMIDITROL is enabled, the thermostat will not allow operation in dehumidification mode.*

*Set point range: 45 to 60% Relative Humidity (RH). Factory default - 50%.*

*Relative Humidity controls to within 2% on either side of RH set point.*

*When the “D” terminal is activated with 24VAC, dehumidification is inactive.*

*NORMAL, MAX and HUMIDITROL modes are disabled by default from the factory.*

*As a precaution, regardless of how low the heating set point has been set, Humiditrol<sup>®</sup> dehumidification is inhibited below 65°F indoor temperature.*

### **Unit Part (Catalog) & Serial Numbers**

A label on the back of the thermostat is visible through an opening in the back of base plate. This identifies the Lennox Catalog Number, Part Number and Serial Number. Separate the base plate from the thermostat to see additional manufacturing information.

### **Memory Protection**

The thermostat stores all the information

concerning its programming (state, mode, program information, last temperature measured) in a nonvolatile memory.

This function avoids the loss of the state of the thermostat when a power-down occurs. The only thing that might be lost is the clock and date information, however, a super capacitor will remember clock / date information for as long as it has a charge (approximately 24 hours). When power down occurs (due to a power outage) the thermostat is able to shut off heat relays (Y1, Y2, W1, W2) when in heating mode and W1 and W2 when in cooling mode. The **O** and **B** relay will maintain their last state. When power is restored the thermostat will be in heat /cool mode so either mode can run to re-satisfy the temperature setting in the home. Day and time (schedules) may be off due to battery loss.

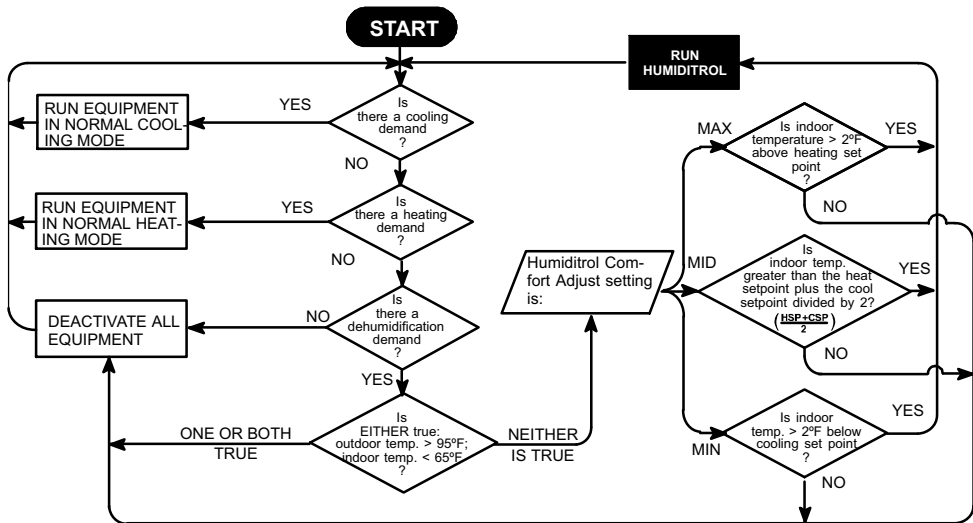


Figure 22. Thermostat Operation with Humiditrol® EDA Enabled

**Table 3. Diagnostic Information**

<b>Error Code</b>	<b>Screen Text</b>	<b>Priority</b> 0:high 1:middle 2:low	<b>Message Type</b>	<b>Condition</b>	<b>System Action</b>	<b>Action to Clear / Recovery Condition</b>
4	high temperature protection	0	critical	High temperature protection when outdoor ambient temperature exceeds 96°F (35.6°C)	All stages of heat are turned off by safety relay.  This error is displayed on notification screen.	Once temperature drops below 96°F (35.6°C), the system resume operation.
5	temperature sensor error	0	critical	Local temperature sensor is out of range -40°F to 158°F  There is a finite difference between main thermistor and sub-thermistor which is greater than 5°F.	Indoor temp is displayed as "--" on the home screen. This will STOP all temperature related operation.  All stages of heat are turned off by safety relay.  This error is displayed on notification screen.	Either thermostat will have to be replace or if the sensor returns to normal operating range, the error message will automatically clear and the system will resume operation.
7	memory error	0	critical	EEPROM error (Power ON)	System will restore using to Energy Star defaults and resume operations.  This error is displayed on notification screen.	Thermostat will need to be replace.

<b>Error Code</b>	<b>Screen Text</b>	<b>Priority</b> 0:high 1:middle 2:low	<b>Message Type</b>	<b>Condition</b>	<b>System Action</b>	<b>Action to Clear / Recovery Condition</b>
8	memory error	0	critical	EEPROM error (Operating)	System will operate in normal mode operation until power off. This error is displayed in notification screen.	Thermostat will need to be replace.
9	no external sensor	1	critical	The outdoor temperature sensor is out of range (-50°F to 180°F)	For Outdoor Temperature Sensor: No Humiditrol or Humidity operation. D terminal stays activated and other operation will continue to operate. Thermostat will stop the system operation if input from requires outdoor temperature information when any of these conditions, i.e. balance point control and 2nd stage lock in are applicable. System will default to mode of operation that does not required input from the outdoor temperature sensor. The temperature display on the home screen will be disabled. If user turns on the display from user settings and error will be displayed again. This error is displayed in notification screen.	Replace outdoor temperature sensor.

Error Code	Screen Text	Priority 0:high 1:middle 2:low	Message Type	Condition	System Action	Action to Clear / Recovery Condition
10	humidity sensor error	1	critical	<p>With humidifier or dehumidifier) and conditions are as follows:</p> <p>0%: Stat will detect error</p> <p>0-5%: Stat may detect error</p> <p>5-95%: Normal operation</p> <p>95-99%: Thermostat may detect error</p> <p>100%: Thermostat will detect error</p>	<p>All humidity operation will stop and the reading for humidity will not be valid.</p> <p>This message indicates hum sensor is not working correctly.</p> <p>The display of Indoor Humidity from HOME will be "--".</p> <p>This error is displayed in notification screen.</p>	<p>Either thermostat will have to be replace or if the sensor returns to normal operating range, the error message will automatically clear and the system will resume operation.</p>

Error Code	Screen Text	Priority 0:high 1:middle 2:low	Message Type	Condition	System Action	Action to Clear / Recovery Condition
11	humidity sensor error	1	critical	Without humidifier or dehumidifier and the sensor reads out of range 0% to 100%.	<p>The reading for humidity will not be valid.</p> <p>This message indicates hum sensor is not working correctly.</p> <p>The display of Indoor Humidity from HOME will be "--".</p> <p>This error is displayed in notification screen.</p>	

**Table 4. Reminder Information**

Error Code	Screen Text	Message Type	Action to Clear / Recovery Condition
12	replace media filter	reminder	Touch either <b>done</b> to clear the reminder or <b>remind later</b> button.
13	replace UV lamp		
14	replace humidity pad		
15	routine system check-up		
16	replace metal insert for pure air		
17	user editable		
18	user editable		

**Table 5. Supported Configurations**

This thermostat support air conditioner and heat pump systems with one or two speed compressors. It also supports dual-fuel and Humiditrol accessory. For all possible configuration see table below.

	Backup/ Indoor Heat	Comp. stages	Back- up/In- door Heat Stages	Heat Stages	1st Heat Stage	2nd Heat Stage	3rd Heat Stage	4th Heat Stage	1st Em Heat Stage	2nd Em heat Stage	Cool Stages	1st Cool Stage	2nd Cool Stage
HP	GAS/OIL	1	1	2	Y1	W1			W1		1	Y1	
HP	GAS/OIL	1	2	3	Y1	W1	W1+W2		W1	W1+W2	1	Y1	
HP	NONE	1	0	1	Y1						1	Y1	
HP	GAS/OIL	2	1	3	Y1	Y1+Y2	W1		W1		2	Y1	Y1+Y2
HP	GAS/OIL	2	2	4	Y1	Y1+Y2	W1	W1+W2	W1	W1+W2	2	Y1	Y1+Y2
HP	NONE	2	0	2	Y1	Y1+Y2					2	Y1	Y1+Y2
HP	ELEC.	1	1	2	Y1	Y1+W1			W1		1	Y1	
HP	ELEC.	1	2	3	Y1	Y1+W1	Y1+W1+W2		W1	W1+W2	1	Y1	
HP	NONE	1	0	1	Y1						1	Y1	
HP	ELEC.	2	1	3	Y1	Y1+Y2	Y1+Y2+W1		W1		2	Y1	Y1+Y2
HP	ELEC.	2	2	4	Y1	Y1+Y2	Y1+Y2+W1	Y1+Y2+W1+W2	W1	W1+W2	2	Y1	Y1+Y2
HP	NONE	2	0	2	Y1	Y1+Y2					2	Y1	Y1+Y2
Non HP	GAS/OIL OR ELEC.	1	1	1	W1						1	Y1	



	Backup/ Indoor Heat	Comp. stages	Back- up/In- door Heat Stages	Heat Stages	1st Heat Stage	2nd Heat Stage	3rd Heat Stage	4th Heat Stage	1st Em Heat Stage	2nd Em heat Stage	Cool Stages	1st Cool Stage	2nd Cool Stage
Non HP	GAS/OIL OR ELEC.	1	2	2	W1	W1+W2					1	Y1	
Non HP	NONE	1	0								1	Y1	
Non HP	GAS/OIL OR ELEC.	2	1	1	W1						2	Y1	Y1+Y2
Non HP	GAS/OIL OR ELEC.	2	2	2	W1	W1+W2					2	Y1	Y1+Y2
Non HP	NONE	2	0								2	Y1	Y1+Y2

**Table 6. Installation Checklist**

<b>Item Number</b>	<b>Item</b>	<b>Yes</b>	<b>No</b>
1	Is the thermostat level where mounted on the wall?		
2	Is the thermostat installed away from direct sunlight or discharge air vents?		
3	Has the thermostat been wired correctly based on the type of equipment installed (air handler, outdoor unit and accessories)?		
4	Is the thermostat wiring secured tightly to the terminals?		
5	Is the common wire (terminal C) connected?		
6	Has the System Test Mode located under the installer settings been used to verify proper operation?		

# INDEX

## B

Balance Points, Low, High, 22

## C

Compressor Short Cycle Protection, 3

Custom Reminder, 34

## D

Deadband, 25

Dealer Information, 25

Dehumidify, 38

*Auxiliary Dehumidifier, 40*

*Humiditrol, 40*

*Max, 39*

*Normal, 39*

Diagnostic Information, 44

Dimensions

*Thermostat, 3*

*Wall Plate, 3*

## E

Energy Saving Defaults, 35

Enhanced Dehumidification Accessory, 12

## F

Features, 3

## H

Humidification Sensor Fault, 41

Humidify, 37

*Dew Point Normal and Max, 38*

*Normal and Max, 37*

Humidity Offset, 25

Humidity Setting, 34

## I

Installation Checklist, 50

Installer Settings, 21

## M

Memory Protection, 42

Menu Screen, 21

## O

Outdoor Sensor (Optional)

*Description, 3*

*Image, 4*

*Installation, 11*

*System Setup, 22*

## **R**

Reminder Information, 47

Reset Settings, 34

Residual Cool, 22

## **S**

Screws, 2

Smooth Set Back (SSR), 25

Smooth Set Back Stage 2 Lock Out, 25

Stage 1 Differential, 26

Stage 2 through 4 Differential, 26

Stage Delay Differentials, 26

Stage Delay Timer, 26

Supported Configurations, 48

System Setup, 21, 22

System Test Modes, 35

## **T**

Temperature Offset, 25

Terminal Designations, 10

Thermostat Installation, 6

## **U**

Unit Part (Catalog) & Serial Numbers, 42

## **W**

Wall Anchors, 2

Wiring Diagrams, 12, 13, 14, 15, 16, 17, 18, 19,  
20

Wiring Thermostat, 10