

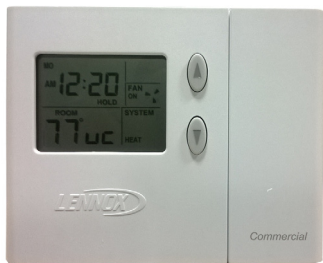

©2015 Lennox Industries Inc.  
Dallas, Texas, USA



**THIS MANUAL MUST BE LEFT WITH THE OWNER  
FOR FUTURE REFERENCE**

## **⚠ WARNING**

**Improper installation, adjustment, alteration, service or maintenance can cause property damage, personal injury or loss of life. Installation and service must be performed by a qualified installer, service agency or the gas supplier**

## OPERATION MANUAL

# **C0STAT05FF1L CS3000 Commercial Programmable Thermostat**

### CONTROLS

507518-01  
2/2015

### **C0STAT05FF1L 5/2 Day Programmable Thermostat**

The Lennox ComfortSense® 3000 Series Commercial Programmable Thermostat, Model C0STAT05FF1L (11Y05) is a 5/2 day programmable and 2-heat / 2-cool electronic thermostat. It includes a programmable filter change reminder, an equipment maintenance reminder, and a system check indicator to notify the user when the equipment requires service.

This thermostat is suitable for 2-stage heat / 2-stage cool applications using a gas or electric auxiliary heat source and can also be used with an economizer.

0215



507518-01

The remote indoor sensor when connected and configured will act as a room temperature sensor instead of internal temperature sensor available with the thermostat. The dip switch is used to select either built-in or external remote indoor temperature sensor used for temperature control.

## Table of Contents

5/2 Day Programmable Thermostat .....	1
General .....	2
Initial Thermostat Power-up .....	2
Buttons, Backlight, Timers & Settings .....	3
DAY/TIME - Set Day and Time .....	4
HEAT - Heat Mode .....	4
COOL - Cool Mode .....	5
HOLD - Temperature Hold Mode .....	6
PROG - Thermostat Programming .....	7
FAN - Controlling Fan Operation .....	9
SETTINGS - Filter and Maintenance Reminders ...	10
SETTINGS - Balance Point .....	11
Service Indicator .....	12
Thermostat RESET .....	12
Removing/Installing Thermostat .....	13
Default Thermostat Settings .....	13
Technical Specifications .....	13

## General

These instructions are intended as a general guide and do not supersede local codes in any way. Consult authorities having jurisdiction before installation. Check equipment for shipping damage. If you find any damage, immediately contact the last carrier.

## Initial Thermostat Power-up

When power is initially applied to the thermostat, the display will appear as shown in figure 1.

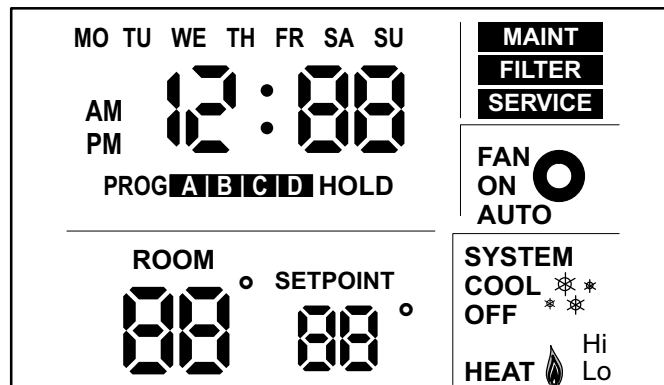

**Figure 1. Initial Power-Up Display**

*NOTE - Tables 3 on page 13 lists all of the system defaults.*

At this point, the thermostat will be fully functional; its default temperature set point (not shown) is 70°F. At this point, if the equipment has been fully powered and if a heat demand were present, the system would begin operating. **UC** indicates unoccupied and **OC** indicates occupied.

*NOTE - Temperature scale default is Fahrenheit units but may be reset to show Celsius, if desired. See page 14.*

## Buttons, Backlight, Timers & Settings

Buttons are located behind the small door on the right-hand side of the thermostat (see figure 2).

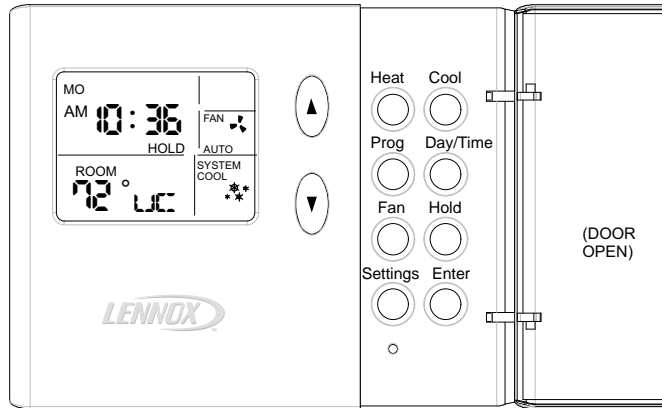

Figure 2. Thermostat Buttons

## ! IMPORTANT

Do NOT begin pressing buttons until after you read the following section describing each button.

A pale blue display backlight illuminates for 30 seconds each time any button is pressed.

When **PROG** or **DAY/TIME** is pressed, a field begins flashing, expecting another input. Start making changes within 15 seconds or the HOME screen will return.

When an **Arrow**, **HOLD**, **HEAT**, or **COOL** button is pressed, setpoint and temperature setting appears for 15 seconds. If desired, start making changes within 15 seconds or the HOME screen will return. The backlight will turn off 15 seconds after the HOME screen reappears.

## DAY/TIME - Setting the Day and Time

Press the **DAY/TIME** button and set the **CURRENT** hour, minute, and day of week as follows:

1. "AM12" will flash on the screen. Press the up or down arrows buttons to change the hour. ("AM" or "PM" must correspond to time of day.) Press **DAY/TIME OR**, if adjusting for daylight savings time, pressing **ENTER** stores the single change and exits to the HOME screen, bypassing minutes and day of week.
2. Minutes will flash. Use the up or down arrow buttons to display the minutes past the hour. Press **DAY/TIME**.
3. Day "MO" (Monday) will flash. Use up or down arrow buttons to display the current day. Day selections are abbreviated as "MO", "TU", "WE", "TH", "FR", "SA", and "SU". Press **DAY/TIME**.
4. The HOME screen reappears; confirm day and time are correct. This completes day and time setting.

## HEAT - Using the Heat Mode

### Enabling Normal Heat Mode

Use the **HEAT** button to enable or disable heat mode. If the thermostat is in OFF or COOL mode, pressing the Heat button enables Heat mode. This is indicated by HEAT in the SYSTEM box as shown in figure 3.

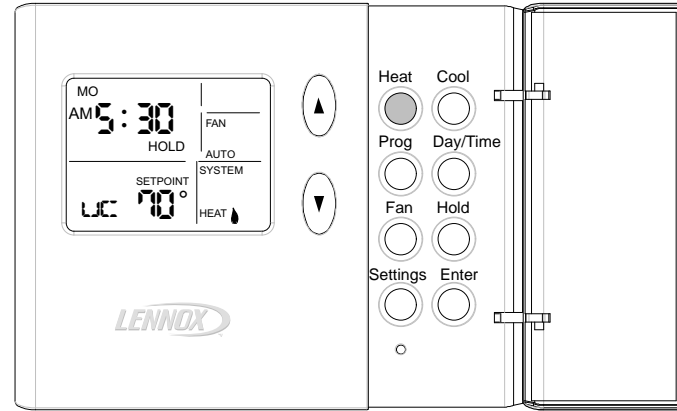

Figure 3. Turn Heat ON/OFF

### Disabling Heat Mode

If the thermostat is in heat mode when the **HEAT** button is pressed, then heat mode is disabled. This is indicated by OFF in the SYSTEM box as shown in figure 4.



Figure 4. Heat Mode Disabled

## Heating Demand

The thermostat must be in heat mode in order to properly control the heating equipment. In heat mode, when the actual temperature is lower than the temperature set point the thermostat detects a heating demand and activates the heating equipment to satisfy the demand. Heating operation is indicated by a flame icon in the SYSTEM box.

When the actual temperature rises above the temperature setpoint, the flame icon will disappear. This indicates that the heating demand has been satisfied and that the heating equipment has been turned off.

There are two timers govern the restart of heating:

1. Minimum furnace off timer (1.5 minutes only for HG).
2. Minimum cycle timer (six minutes).

For example:

If heating has been on for over six minutes then minimum cycle timer is already fulfilled. For HG (gas), it will restart after 1.5 minutes. For HE (electric), it will restart immediately.

If the heating has not been on for six minutes, it will make up the six minutes during the off time. Therefore the lock out time is never six minutes.

## COOL - Using the Cool Mode

### Enabling and Disabling Cool Mode

Use the **COOL** button to enable or disable cool mode as desired. If the thermostat is in HEAT or OFF mode, cool mode is enabled when the **COOL** button is pressed. This is indicated by COOL in the SYSTEM box (see figure 5).

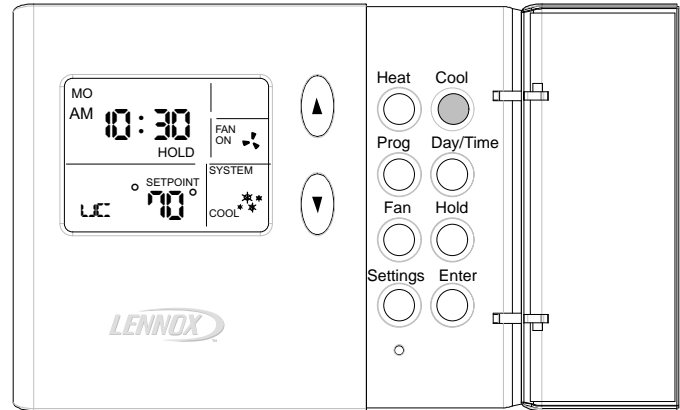
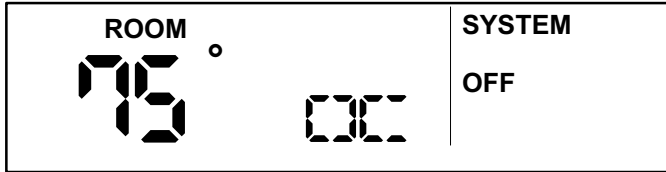

Figure 5. Turn Cool ON/OFF

If the thermostat is in cool mode, pressing the **COOL** button disables COOL mode (indicated by OFF in the SYSTEM box - see figure 6).



**Figure 6. Cool Mode Disabled**

### Cooling Demand

Set the thermostat to cool mode to control the cooling equipment. Then, if the room temperature is higher than the temperature setpoint, the thermostat detects a cooling demand and will activate the cooling equipment to satisfy the demand.

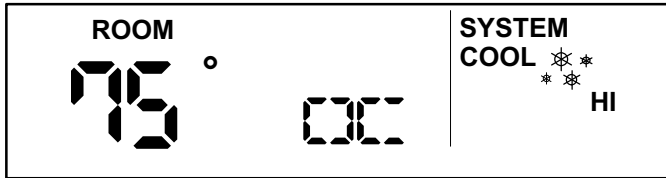

**Figure 7. Cooling Demand**

Cooling operation is indicated by flashing “snowflake” icons in the SYSTEM box. When the actual temperature drops below the temperature setpoint, the snowflake icons will

disappear. This indicates that the cooling demand has been satisfied and that the cooling equipment has been turned off.

If a large cooling demand is present, “Hi” will be displayed in the SYSTEM box (shown in figure 7).

*NOTE - If no buttons are pressed during a demand for cooling, the equipment must operate for at least four minutes. After a demand has been satisfied, cooling equipment operation is locked out for five minutes. If another cooling demand occurs during this 5-minute interval, “COOL” and the snowflakes will flash; however, the cooling equipment will not operate until the 5-minute delay has elapsed.*

### **HOLD - Using Temperature Hold Modes**

When HOLD is displayed on the HOME screen, the thermostat is in a temperature hold condition. This means that the temperature program data is ignored and the thermostat functions much like a non-programmable thermostat.

### **Adjusting Temperature Setpoint in Hold Mode**

The temperature setpoint represents the desired temperature of the space around the thermostat.

To adjust the setpoint, press the up or down (▲▼) arrow buttons the existing setpoint is displayed to the right of the

occupancy mode. Each button press adjusts the setpoint up or down by 1 degree.

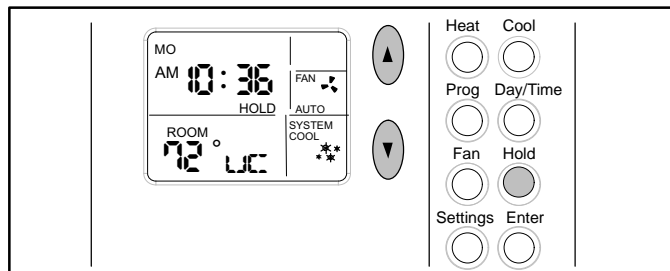

**Figure 8. Hold Temperature Mode**

After the desired setpoint is reached, the HOME screen will reappear after about 15 seconds (see figure 8).

### Permanent Hold Mode

At any time the program is running, from the HOME screen, set a permanent hold (program override) by pressing the **HOLD** button (see figure 8). The thermostat now functions much like a non-programmable thermostat. Use the Up/Down arrow buttons to adjust the hold set point. To return to the program, press **HOLD** again. The occupancy status will remain unchanged in permanent hold mode.

### Temporary (2-Hour) Hold

At any time the program is running, from the HOME screen, set a temporary 2-hour hold by pressing the up or down

arrow buttons until the desired set point is displayed; “HOLD” flashes (see figure 9). This overrides the program for 2 hours from the last button press, then returns to the program.

To change occupancy status in temporary hold mode, press the **ENTER** button while HOLD indicator flashes. The occupancy can be set to OC (occupied) / UC (unoccupied) by pressing the **ENTER** button.

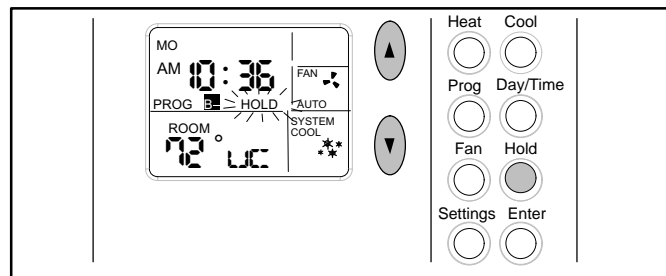

**Figure 9. Temporary Hold Temperature Mode**

While in Temporary Hold, press **HOLD** once to switch to Permanent Hold (HOLD displays solid; PROG not displayed); press **HOLD** again to return to the program (PROG displays; HOLD not displayed).

## PROG - Thermostat Programming

The thermostat can be programmed to perform a set of either heating or cooling events (but not a combination of

heat and cool) for five consecutive days using a set of four unique events per day. The remaining two days can then be set for a different set of four unique events per day. Both the consecutive days and the events/temperature are set by the user.

### To Change Consecutive Days...

To alter the five consecutive days, **press and hold the PROG** button for three seconds. The five consecutive day period is then displayed (default is MOnday thru FRiday). To change to a different 5-consecutive days, use the up or down arrow buttons. Any five consecutive-day span may be selected, for example, in figure 10, Saturday through Wednesday is defined as the 5-day programming (Thursday and Friday would constitute the 2-day programming). Press the **PROG** button when finished.

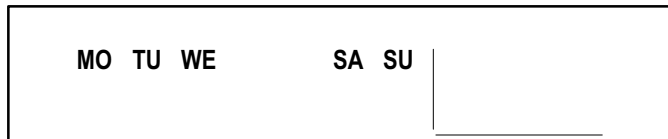

**Figure 10. Change Consecutive days**

### To Set Program Events and Temperatures...

Figure 11 gives an example of how the two sets of programs can be set for a normal workweek and weekend.

In the 5-day bar graph, note how programs **A** and **C** reflect the desired warmth while the location **IS** occupied (72°); **B**

allows less heating while the location is **NOT** occupied; **D** reflects a cooler sleeping temperature. The 2-day bar graph would support day-long occupancy and, because the first program begins later, a less-demanding time schedule.

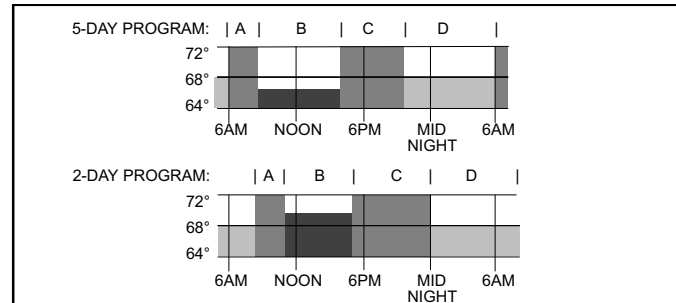

**Figure 11. 5/2 Day Program Example**

*NOTE - Pressing **ENTER** during the following programming steps, saves and exits to the HOME screen.*

To program events and temperatures, perform the following steps, once with Cool selected and once with Heat selected.

1. Press either the **HEAT** or **COOL** button.
2. Press and release **PROG**. “AM 6:00”, period “A”, and the 5 consecutive days are displayed; “AM 6” flashes.
3. Use the up or down arrow buttons to select the desired hour; press **PROG** when the desired hour is reached.
4. Use the up or down arrow buttons to select the desired minute; press **PROG**.



5. Use the up or down arrow buttons to select either **uc** (unoccupied) or **oc** (occupied) minute; press **PROG**.
6. Use the up or down arrow buttons to select the desired temperature set point; press **PROG**.
7. Repeat steps 3 through 6 for periods B, C, and D.
8. Repeat steps 1 through 7 for the 2-day program.

*NOTE - This thermostat will NOT automatically switch from heating to cooling, or cooling to heating; operator involvement is required. At the change of seasons, or to accommodate abnormal seasonal temperature swings, you must manually select to the opposite conditioning (Heat or Cool) program.*

### FAN - Controlling the Fan Operation

Use the **FAN** button to select either continuous fan mode or auto fan mode.

To change from continuous to auto fan mode or back to continuous, press the **FAN** button. Note whether a fan icon in the FAN box is present (indicating that the fan is running) or not (fan not running).

If continuous fan mode is enabled (ON displayed in FAN box - see figure 12), the fan will run continuously regardless of whether the heating or cooling equipment is running.

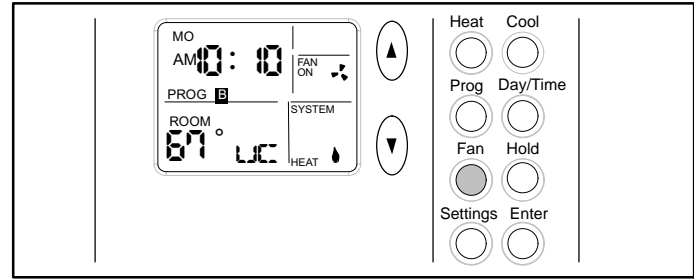

**Figure 12. Using Fan ON**

If auto fan mode is selected (AUTO displayed in FAN box - see figure 13), the fan will only run when the heating or cooling equipment is running.

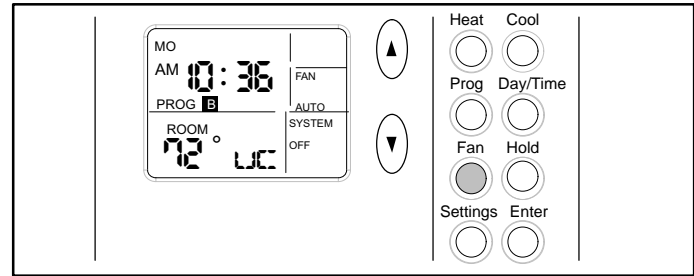

**Figure 13. Using Fan AUTO**

## SETTINGS - Filter/Maintenance Reminders

The thermostat is designed to remind you when the filter needs changing or when routine maintenance is required, as (and if) defined, by you. These optional reminders are not enabled until you activate them. To do so, press the **SETTINGS** button (shown below the Fan button in figure 13) once or twice for the desired reminder as shown in figure 14 and as described in table 1.

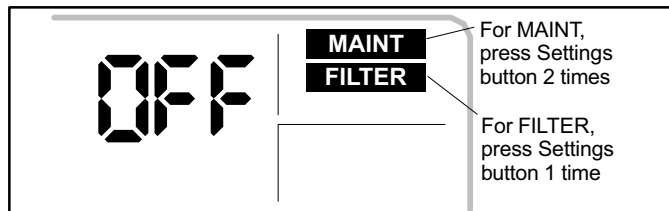

**Figure 14. Reminder Settings Display**

The default setting for the reminders is OFF (disabled). Press either the up or down arrow buttons to select the desired reminder intervals.

**Table 1. Filter and Maintenance Reminders**

Buttons to Use	Reminder	Available Settings and How to Use
<b>Settings</b> (1st press) then <b>Arrows</b> to scroll selections	<b>FILTER</b>	Total fan run time expressed in months (Off, 1, 3, 6, 12); for example, if fan runs 12 hours a day, 1 month reminder displays in 2 calendar months.
<b>Settings</b> (2nd press) then <b>Arrows</b> to scroll selections	<b>MAINT</b>	Elapsed chronological time in months (Off, 6, 12). Use this, for example, to remind yourself when to perform routine checks or when to call a technician for periodic preventive maintenance.
<b>Enter</b>		Stores settings.

*NOTE - The HOME screen will reappear about 15 seconds after the final arrow button press. OR, press **ENTER** at any time to store any changes and exit to the HOME screen. After either programmed interval has elapsed, the reminder will be displayed as shown in figure 15.*

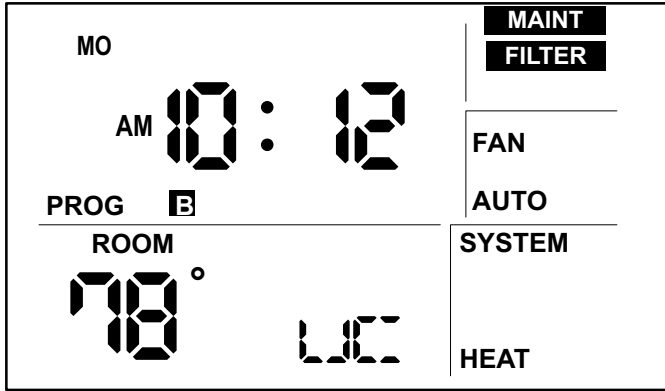

**Figure 15. Reminders**

After the filter has been changed or maintenance performed, reset the reminder by pressing the **SETTINGS** button for four seconds. The screen will blink for a few moments to indicate that the timer has been reset.

### Internal/Remote Sensor

If the optional Remote Indoor Sensor (10K) (47W37) is connected and configured it will serve as a room temperature sensor instead of using the internal temperature sensor built into the thermostat. The dip switch (position #4) is used to select either built-in or external

remote indoor temperature sensor used for temperature control.

### Occupied and Unoccupied Modes

During permanent hold mode the occupancy output follows the program. During two hour hold mode the user can change the occupancy status by pressing the enter button. The occupancy status will be changed to occupied **OC** or Unoccupied **UC** alternatively by pressing the enter button.

The occupancy relay is turned on when the user selected the occupancy status during programming. The default state of the occupancy relay is off. The occupancy relay will turn on the economizer in the system

**Table 2. Thermostat Outputs (Occupancy)**

Demand Condition	W1	W2	OC	Y1	Y2	G
<b>Cooling Demands with Occupancy</b>						
First Stage Cooling			X	X		X
Second Stage Cooling			X	X	X	X
No Demand - Continuous mode			X			X
No Demand - Auto mode			X			
<b>Heating Demands with Occupancy</b>						
First Stage Heating	X		X			X
Second Stage heating	X	X	X			X
No Demand - Continuous mode			X			X
No Demand - Auto mode			X			X

## Service Indicator

When abnormal equipment operation is detected, the SERVICE indicator will flash on the screen (see figure 16). This indicates that the equipment requires service from a qualified service technician.

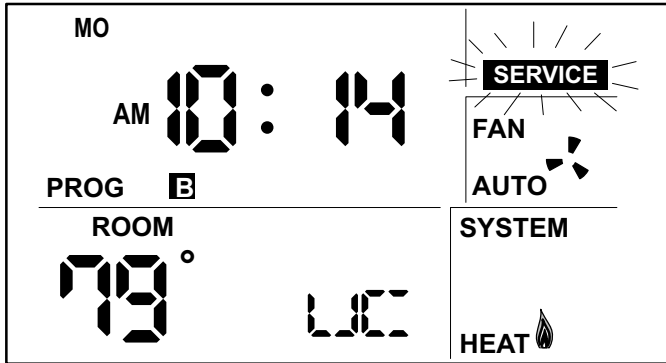

Figure 16. Service Indicator Flashing

## Thermostat RESET

Under some abnormal conditions, it may be necessary to “reset” the thermostat to its default condition. Such a RESET would delete all programming and settings and therefore should only be used on rare occasions when the thermostat fails to function as designed and/or as

programmed. Such an instance can occur as a result of a power surge or similar electrical disturbance (e.g. after an electrical storm or power outage). The RESET button can be used to recover from this situation.

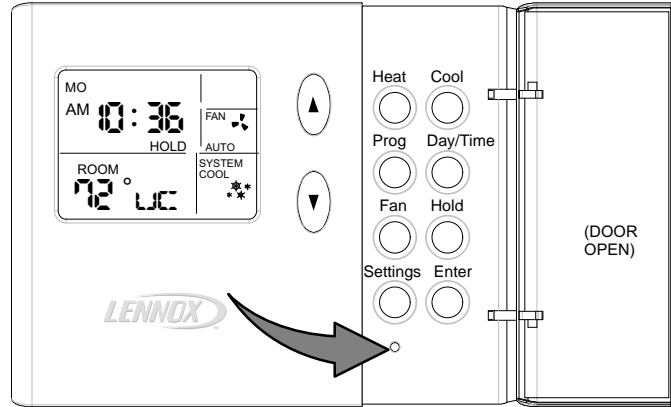

Figure 17. Reset Button

## ⚠ CAUTION

When the RESET button is pressed, ALL settings revert back to their defaults (see tables 3 on page 13).

The RESET button is an unlabeled, recessed button located behind the door, on the right-hand side of the thermostat,

below the SETTINGS button (see figure 17). Use a paper clip or small pencil to press the RESET button; ALL thermostat settings will be reset to the defaults listed in the Default Thermostat Settings section.

### Removing/Installing Thermostat

The thermostat hinges on tabs on the top of the sub-base; no tool is needed to remove the thermostat from the sub-base. Pivot the bottom of the thermostat outward (releasing the snaps), then lift up to remove.

To replace it, first position the top tilted toward the wall bracket and align it until you feel the tabs and slots engage; then, while the top is in place, pivot the bottom toward the wall until the thermostat snaps into place.

### Default Thermostat Settings

Default thermostat settings are shown in table 3.

**Table 3. Default Thermostat Settings**

Mode	Heat (Permanent Hold Mode)
Setpoint	70°F (or 21°C)
Fan	Auto
Filter Reminder	OFF
Maintenance Reminder	OFF
Equipment Protection Timers	Reset Back to Zero

### Technical Specifications

#### Thermostat Type

Electronic programmable thermostat for non-heat pump, 2-stage heat / 2-stage cool.

#### Power Supply Range

18VAC - 30VAC (24VAC nominal), 60Hz

### CAUTION

24VAC is present on the terminals of the thermostat bracket. If removing the thermostat from the wall, use caution and avoid touching any of the connector terminals on the wall bracket.

Also, when working with the thermostat dip switches, use a non-conductive tool and take caution to avoid making any contact with the circuit board, its imprinted circuitry and its connector prongs.

#### Temperature Display

Display Scale: Fahrenheit or Celsius user selectable

Display range: 35°F (2°C) to 99°F (37°C)

Display resolution: 1°F (1°C)

Display Accuracy: +/-1°F

### Setting Temperature Scale

To select either Fahrenheit or Celsius, press **Settings** button three times. Press **up/down arrows** to toggle between Fahrenheit and Celsius. Once selected, press **Settings** button to exit.

### Selecting Internal or Remote Sensor

To select between the internal or remove temperature sensor use dip switch #4. Factor default setting is set to internal sensor (OFF)

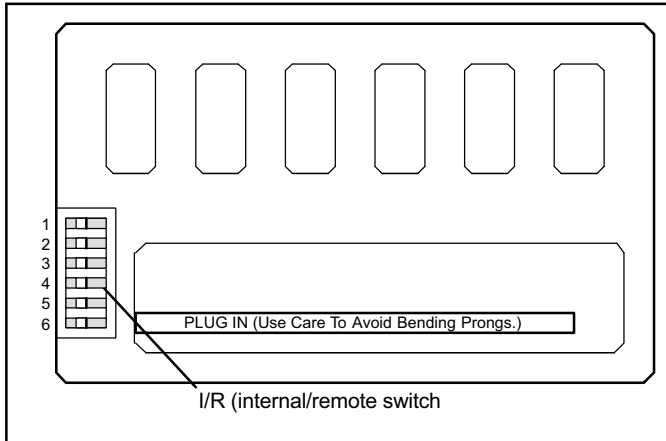

**Figure 18. Internal/Remote Sensor Settings**

### Temperature Measurement Range

Measurement Scale: Fahrenheit

Measurement Range: 35°F to 99°F

Measurement Resolution: 0.125°F

Measurement Accuracy: +/-1°F

Field Offset: via DIP switches to +/-3°F

Sampling Method: temperature measurements sampled every two seconds. Displayed temperature is the average of the last four measurements.

### Temperature Set Point Range

Setting range: 50°F (10°C) to 90°F (32°C)

Setting resolution: 1°F (1°C)

### Smooth Setback Recovery (via DIP switch #6)

Smooth Setback Recovery (SSR) affects the way the thermostat responds to program events. If SSR is disabled, the thermostat will react to a program event at the time the event occurs. However, if SSR is enabled, the thermostat will react to a program event before the event occurs such that the desired temperature is reached at the time of the event, not after.

### Fan Control

AUTO or ON modes.

### I/O Relays

All thermostat relays are latching type to minimize power consumption.

**Table 4. Terminal Designations**

Terminal	Description
R	24VAC
Y1	Compressor Stage 1 cooling
W1	Stage 1 heating
Y2	Compressor Stage 2 cooling
W2	Stage 2 heating
G	Fan
L	Service indicator
C	Common 24VAC
T	Remote Temperature Sensor connection 2
T	Remote Temperature Sensor connection 2
OC	Occupancy output (economizer)

**Equipment Protection Timers**

Minimum Compressor OFF time: 5 minutes

Minimum Compressor ON time: 4 minutes

Minimum Electric Heat ON time: 3 minutes

Minimum Furnace ON time: 3 minutes

Minimum Furnace OFF time: 1-1/2 minutes

Minimum cycle time (applies to both furnace cycle and elapsed time) between any furnace activation and the next furnace activation): 6 minutes.

Minimum elapsed time between any compressor activation and the next compressor activation: 6 minutes.

*NOTE - All protection timers (except the compressor OFF timer) can be over-ridden if a heating or cooling demand is initiated or terminated using the UP, DOWN, HEAT, or COOL buttons.*

**Equipment Protection Override**

Both the minimum compressor OFF timer and the minimum equipment cycle timer can be over-ridden by pressing and holding either the **HEAT** or **COOL** button down for four seconds.

**Filter Reminder**

Settings of Off, 1, 3, 6 or 12 (months of fan run time) are available. When programmed time has elapsed, a FILTER indicator is displayed.

**Maintenance Reminder**

Settings of Off, 6 or 12 (months of chronological time) are available. When programmed time has elapsed, a maintenance indicator "MAINT" is displayed.

### Service Reminder

The SERVICE indicator is displayed only under the following conditions:

- if the thermostat Y1 terminal has been activated with 24VAC for at least 5 minutes, AND the L terminal is shorted to the R terminal;

OR

- if the thermostat Y1 terminal has been activated with 24VAC for at least 5 minutes, AND the L terminal is shorted to the C terminal.

### Power Loss/Recovery

Thermostat memory is retained for a minimum of 24 hours during a power loss (includes retention of program information, HOLD status, programmed temperature set point, heat/cool and fan mode settings, filter reminder status, maintenance reminder status, and equipment protection timers). After 24 hours of power loss, programmed settings will be lost and replaced with default settings.

## IMPORTANT

Power must be applied for at least six consecutive hours prior to a power loss in order for memory to be retained for the specified time.

### LCD Back Light

Activated for 30 seconds when any button is pressed.

*NOTE - During an electrical storm or similar disturbance, the back light may activate for a few seconds. This is normal and will no longer occur after the electrical disturbance has passed.*

### Thermostat Operating Conditions

32°F to 122°F, 10% to 90% RH

### Thermostat Storage Conditions

-40°F to 176°F, 10% to 90% RH