



©2015 Lennox Industries Inc.
Dallas, Texas, USA



INSTALLATION/ OPERATION INSTRUCTIONS

Lennox Light Commercial Mini-Split Systems Wired Indoor Unit Controller

CONTROLS

507561-01

06/2015

This manual must be left with the owner for future reference.

⚠ WARNING

Improper installation, adjustment, alteration, service or maintenance can cause property damage, personal injury or loss of life. Installation and service must be performed by a licensed professional HVAC installer (or equivalent) or service agency.

IMPORTANT!

Frequent changes to operating mode may cause system malfunction. Allow at least one minute between mode changes to allow the system to stabilize.

Shipping and Packing List

Package 1 of 1 contains;

- 1 – Wired Controller
- 1 – Installation and operation manual
- 1 – Cable with connector – 20 ft. (6 m)

General

The M0STAT61Q-1 mini-split wired controller is a wired local controller for Lennox light commercial mini-split indoor units.

Requirements

Turn off power supply before beginning installation. Use this controller only as described in this manual. Do not install the controller on outside walls (where there is unconditioned space on opposite side of wall) or in locations where direct sunlight may be present.

Installation

⚠ WARNING

Be sure that power supply has been turned off before beginning installation.

⚠ CAUTION

Clean controller using a clean, damp cloth. Do not spray cleanser on or around controller.

⚠ WARNING

Do not operate controller with wet hands.

⚠ CAUTION

Do not install controller in areas where heavy oil, vapor, or gases containing sulfur may exist or the controller may be damaged.

IMPORTANT!

Read all of the information in this manual before using this controller. All wiring must conform to local and national building and electrical codes and ordinances. This is a 5 VDC controller. Do not install on voltages higher than 5 VDC.

- This manual provides the installation instructions for this controller. Refer to the included wiring diagram to connect the controller to the indoor unit.
- The controller uses low voltage. Keep a minimum distance of 12" (305 mm) between low voltage control wire and high voltage power wires.

IMPORTANT!

The provided cables must be used. Do not use excessive force while pulling the cable or when making the connections.

- Ground the shielded control wiring.
- Do not use a megger to test insulation.
- The controller cable length should not exceed 40 ft. (12 m).

1. Connect controller to indoor unit main control board by inserting the plug of the 5-conductor cable into the socket provided at the indoor unit

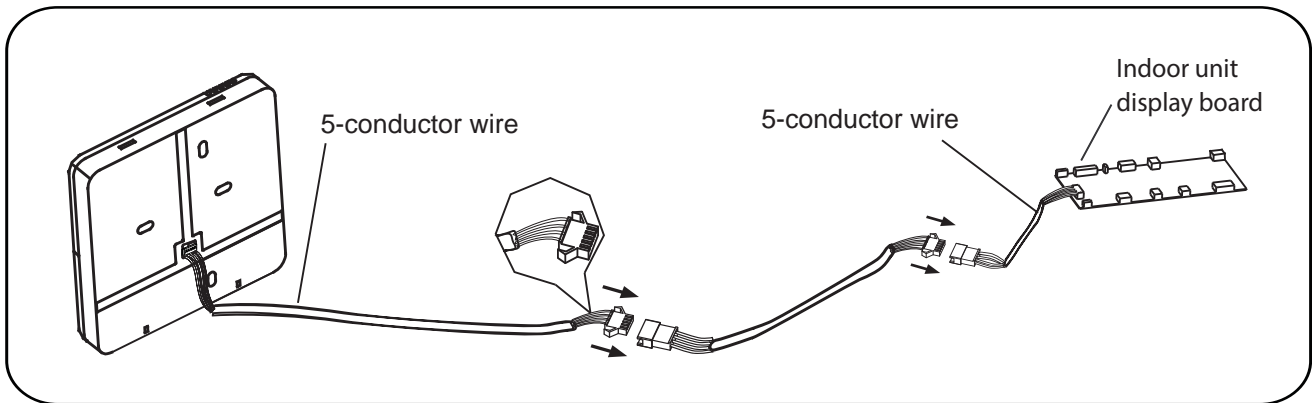

Figure 1. Wiring Connections

2. Remove the cover from the wall plate using a flat-head screwdriver. See figure 2.
 3. Mount the wall plate as appropriate for your application. See figure 3.
- NOTE** – Provide for future maintenance by allowing enough slack in the wiring to allow the controller to be removed from the wall if needed.

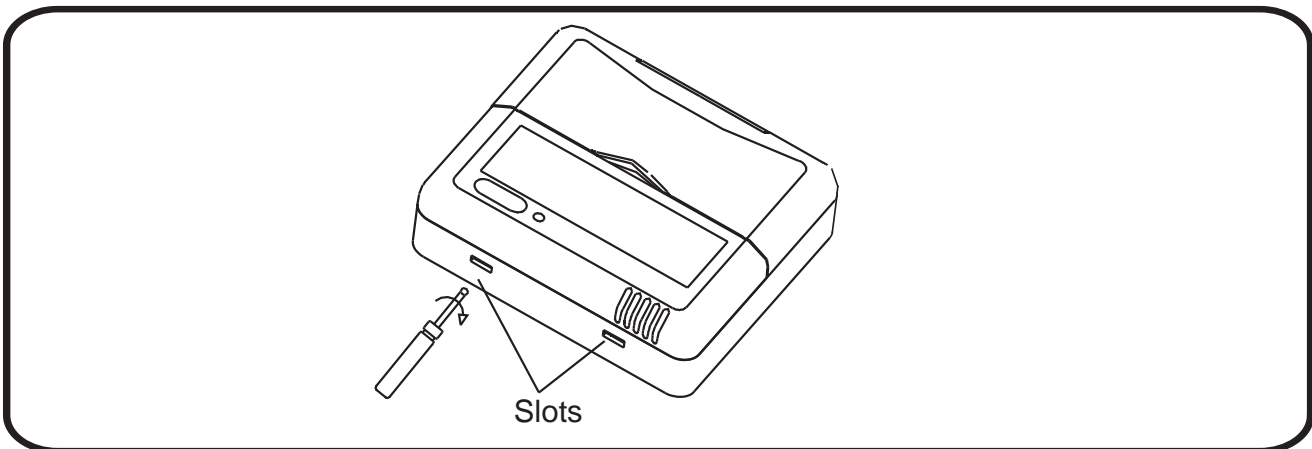

Figure 2. Remove cover from wall plate.

4. Attach the wall plate using the provided screws. See figure 3.

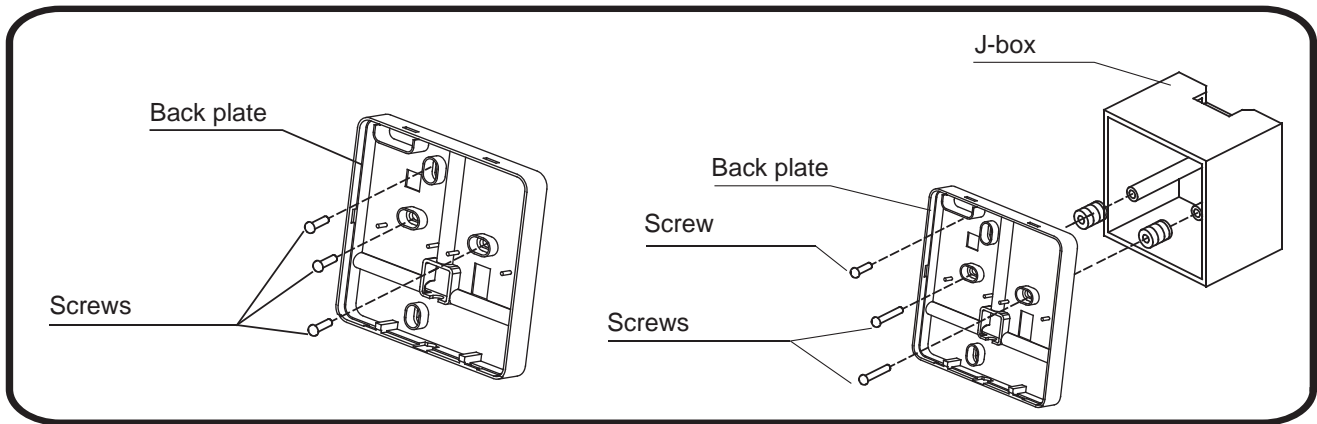

Figure 3. Mount wall plate

5. Reattach the cover to the wallplate. See figure 4.

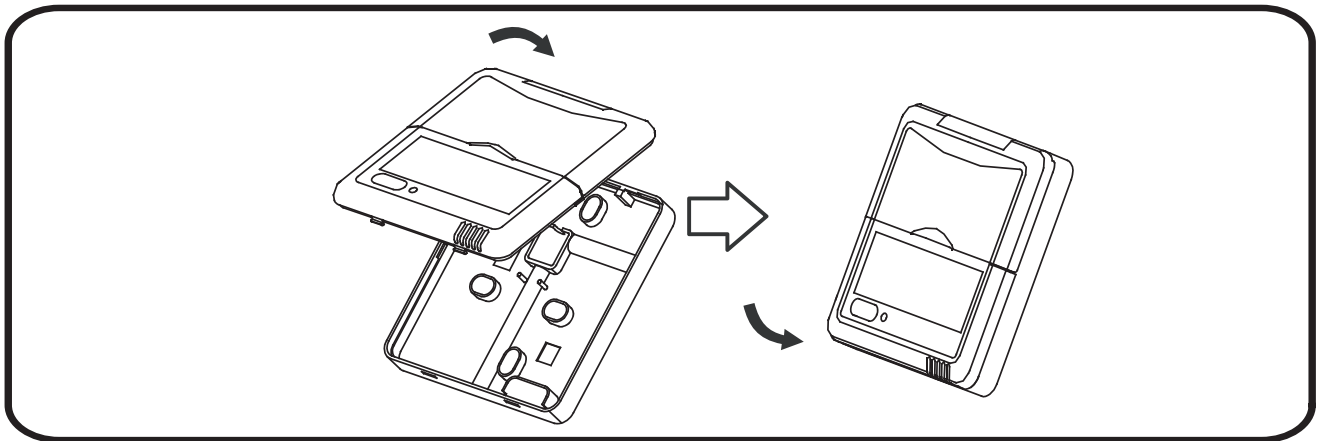

Figure 4. Reattach cover to wall plate

Field Wiring Diagram

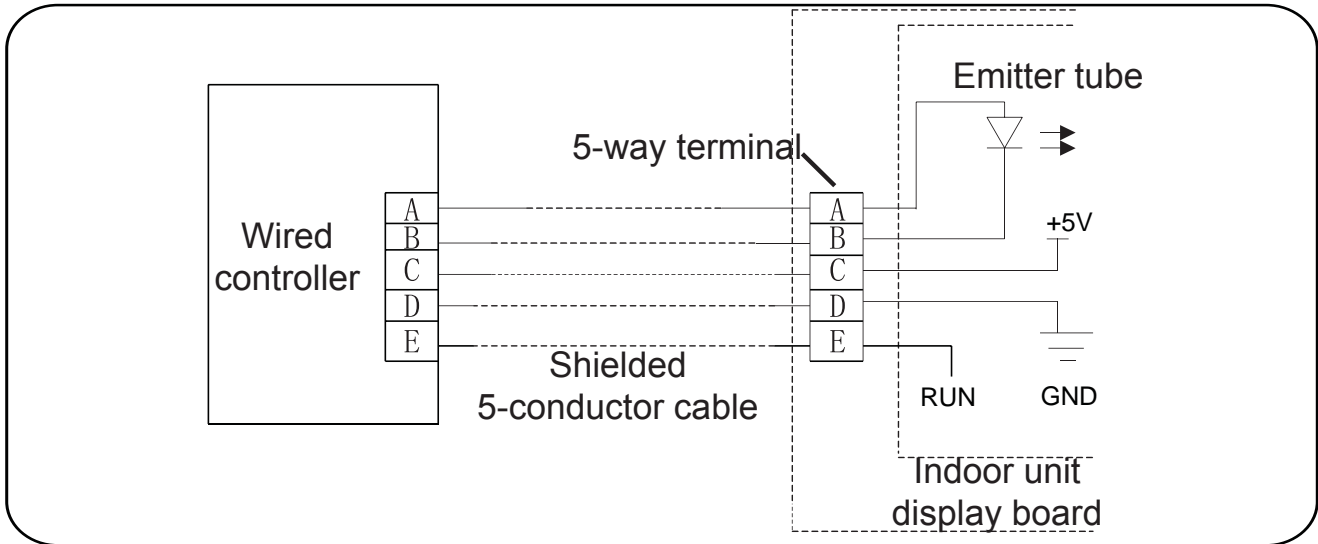

Figure 5. Typical wiring diagram between wired controller and indoor unit

Specifications

Table 1. Specifications

Input voltage	5 VDC
Ambient temperature	23~110°F (-5~43°C)
Ambient humidity	RH40%~RH90%

Display

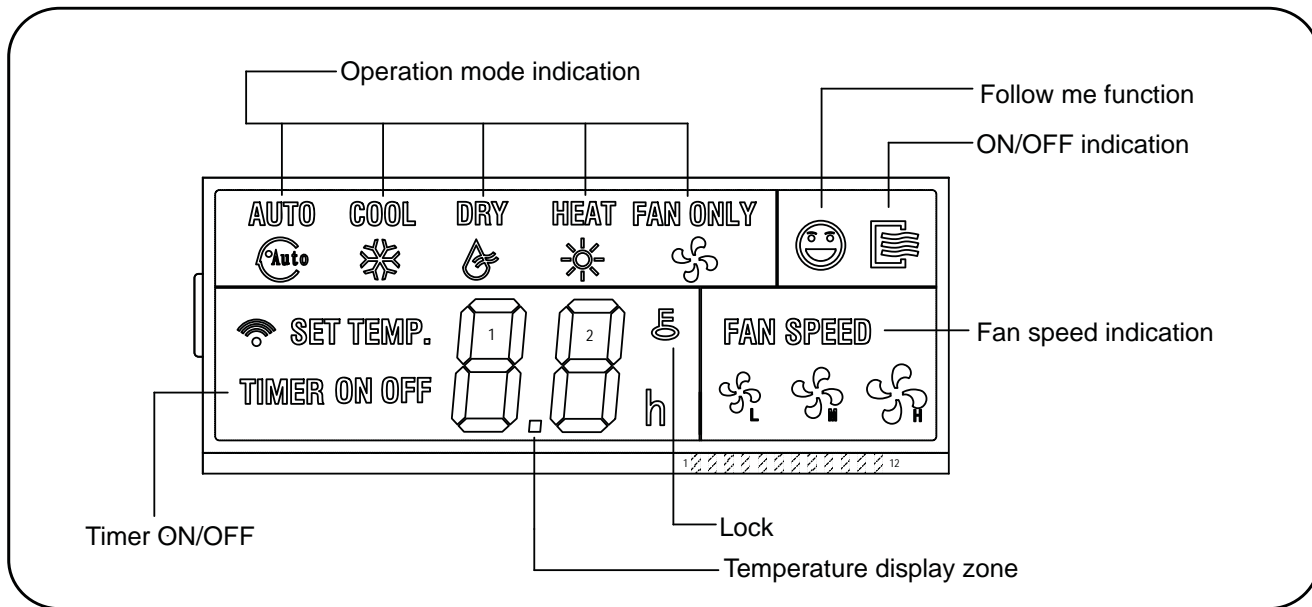

- **Operation mode.** These icons show the current mode of operation. Press the mode button to scroll through the operation modes: Auto → Cool → Dry → Heat → Fan.
- **Timer ON/OFF.** These icons light to indicate that the indoor unit has a timed auto-start or auto-stop set .
- **Follow me.** This icon displays when the air temperature sensor in the wired remote controller is the sensor being used by the indoor unit. When this function is off, the indoor unit uses a built-in sensor.
- **ON/OFF.** This icon displays when the indoor unit is turned on.
- **Fan speed.** Displays the current fan speed.
- **Lock.** This icon displays when the controller is locked.
- **Temperature display.** Displays set-point temperature.

Description of Buttons

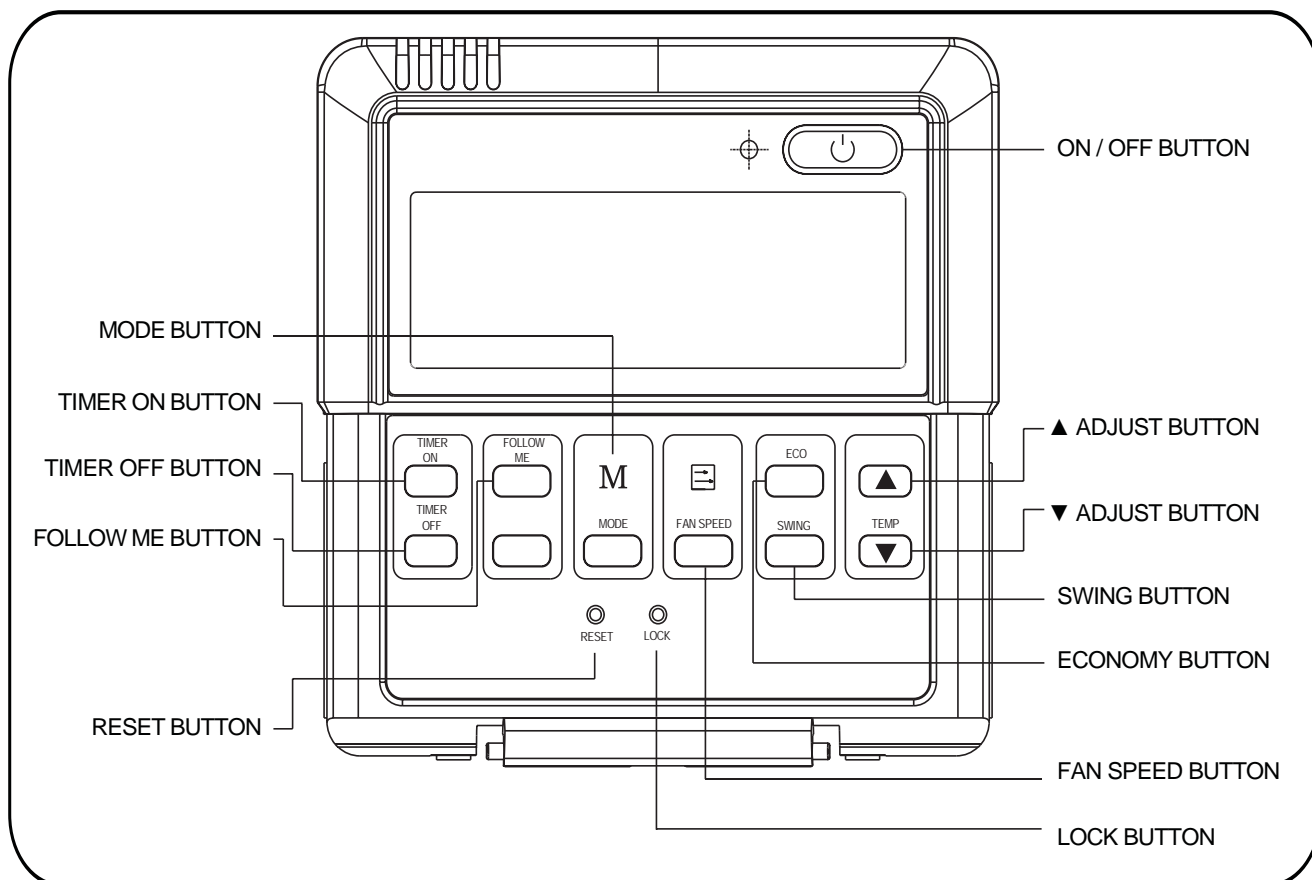

- **Mode button.** Press to scroll through the operation modes: Auto → Cool → Dry → Heat → Fan.
- **Timer ON button.** Press to set the number of hours of delay before the indoor unit begins operation.
- **Timer OFF button.** Press to set the number of hours of delay before the indoor unit stops operation.
- **Follow Me button.** Press to activate the controller's air temperature sensor. This transfers the temperature sensing function from the indoor unit to the controller. The indoor unit's air temperature sensor will be disabled.
- **Reset button.** Using a blunt-tipped device (paper clip), press to cancel current settings and reset remote controller to factory settings.
- **On/Off button.** Press to turn the indoor unit on or off.
- **Up arrow button.** Press to increase the temperature setpoint or to scroll through settings options.
- **Down arrow button.** Press to decrease the temperature setpoint or scroll through settings options.
- **Swing button.** Press once to initiate louver left & right oscillation. Press again to stop louver oscillation. Louvers remain in place where stopped. Not available in all indoor unit models.
- **Economy button.** Not used.
- **Fan speed.** Press to scroll through the fan speeds: Auto → Low → Med → High
- **Lock button.** Using a blunt-tipped device (paper clip), press to lock or unlock the current setting.

Operation

Start/stop operation

Press the LED power button.

- Controller ON: Power button LED lit brightly.
- Controller OFF: Power button LED not lit.

Select Fahrenheit or Celsius Display

Press and Up and Down buttons at the same time, and hold for three seconds to toggle between Fahrenheit and Celsius.

To set the operation mode

Press the Mode button to scroll through the mode selections.

- Auto – System operates in cooling or heating mode as determined by the setpoint and the room temperature.
- Cool – System operates in cooling mode.
- Dry – System removes humidity according to preset conditions (fan speed and setpoint temperature, not a humidistat sensor). Cannot adjust fan speed.
- Heat – System operates in heating mode.
- Fan – Fan only, no heating or cooling.

To set (or change) the room temperature setting (setpoint)

Press the up arrow & down arrow buttons to adjust the setpoint.

Dry mode

1. Press the Power button, an LED light on the indoor unit displays.
2. Press the Mode button to select Dry.
3. Adjust the temperature setpoint using up and down arrow buttons.

NOTE – Fan speed is not adjustable.

Timer operation

Timer ON and Timer OFF are used to turn on and turn off the indoor unit at selected intervals.

Timer ON operation

1. Press the Timer ON button. The Timer on icon, the last auto-on time, and “h” will display.
2. Press the Timer ON button again to set the amount of time before the indoor unit begins operation. Each press will increase the time in half hour increments until 10 hours, then the increment becomes 1 hour.

Timer OFF operation

1. Press the Timer OFF button. The Timer off icon, the last auto-off time, and “h” will display.
2. Press the Timer OFF button again to set the amount of time before the indoor unit stops operation. Each press will increase the time in half hour increments until 10 hours, then the increment becomes 1 hour.

Modify Timer ON/OFF settings

1. Press either the Timer ON button or the Timer OFF button to modify that setting.
2. Continue to press the Timer ON or Timer OFF button until the display shows the new time. Each press will increase the time in half hour increments until 10 hours, then the increment becomes 1 hour.
3. Set the timer to 0.0 to turn off timed operation.

Troubleshooting

Fault Codes (indoor unit)

F0	Wired remote controller and indoor unit communication failure
E1	Indoor unit and outdoor unit communication failure
E2	T1 sensor malfunction
E3	T2A sensor malfunction
E4	T2B sensor malfunction
E7	Indoor unit EEPROM failure
Ed	Outdoor unit malfunction
EE	Condensate pump malfunction