

KEY	DESCRIPTION
7	ELECTRIC HEAT SUB-BASE KIT
37	ELECTRIC HEAT LIMIT
265	CONTACTOR RELAY
266	HEATING CONTROL
271	HEATING SENSORS STG 1
272	HEATING SENSORS STG 2

KEY	DESCRIPTION
A55	CONTROL, BOARD LENNOX
A178	PANEL, COMP 3 & 4, C3 2nd STAGE HEAT
F3	FUSE, ELECTRIC HEAT
F4	FUSE, UNIT
F42	FUSE, ELECTRIC HEAT 1A, 2A
F43	FUSE, ELECTRIC HEAT 3, 4
F44	FUSE, ELECTRIC HEAT 5
F49	FUSE, ELECTRIC HEAT 7
F50	FUSE, ELECTRIC HEAT 8
HE1	ELEMENT, ELECTRIC HEAT 1
HE2	ELEMENT, ELECTRIC HEAT 2
HE3	ELEMENT, ELECTRIC HEAT 3
HE4	ELEMENT, ELECTRIC HEAT 4
HE5	ELEMENT, ELECTRIC HEAT 5
HE6	ELEMENT, ELECTRIC HEAT 6
HE7	ELEMENT, ELECTRIC HEAT 7
HE10	ELEMENT, ELECTRIC HEAT 10
HE11	ELEMENT, ELECTRIC HEAT 11
HE12	ELEMENT, ELECTRIC HEAT 12
HE13	ELEMENT, ELECTRIC HEAT 13
HE14	ELEMENT, ELECTRIC HEAT 14
K9-1	RELAY, HEAT
K15-1	CONTACTOR, ELECTRIC HEAT 1,2
K16-1	CONTACTOR, ELECTRIC HEAT 1A,2A
K17-1	CONTACTOR, ELECTRIC HEAT 3,4
K18-1	CONTACTOR, ELECTRIC HEAT 5,6
K242	CONTACTOR, ELECTRIC HEAT 1
K243	CONTACTOR, ELECTRIC HEAT 2
K245	CONTACTOR, ELECTRIC HEAT 4
S15	SWITCH, LIMIT PRIMARY ELECTRIC HEAT
S20	SWITCH, LIMIT SECONDARY ELECTRIC HEAT 1,2
S107	SWITCH, PRIMARY ELECTRIC HEAT
S157	SWITCH, LIMIT SECONDARY ELECTRIC HEAT 1A
S158	SWITCH, LIMIT SECONDARY ELECTRIC HEAT 2A
S159	SWITCH, LIMIT SECONDARY ELECTRIC HEAT 3,4
S160	SWITCH, LIMIT SECONDARY ELECTRIC HEAT 5,6
S161	TERMINAL STRIP, UNIT
S171	TERMINAL STRIP, UNIT
S172	TERMINAL STRIP, UNIT
TB2	TERMINAL STRIP, UNIT
TB3	TERMINAL STRIP, ELECTRIC HEAT

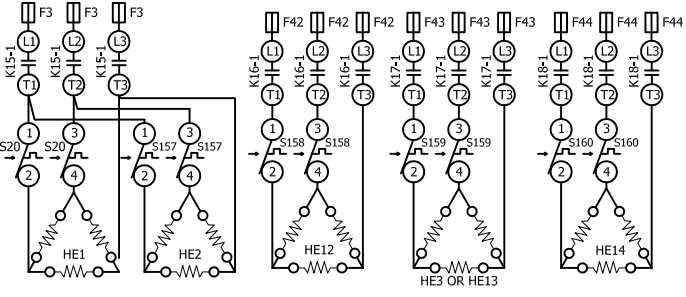
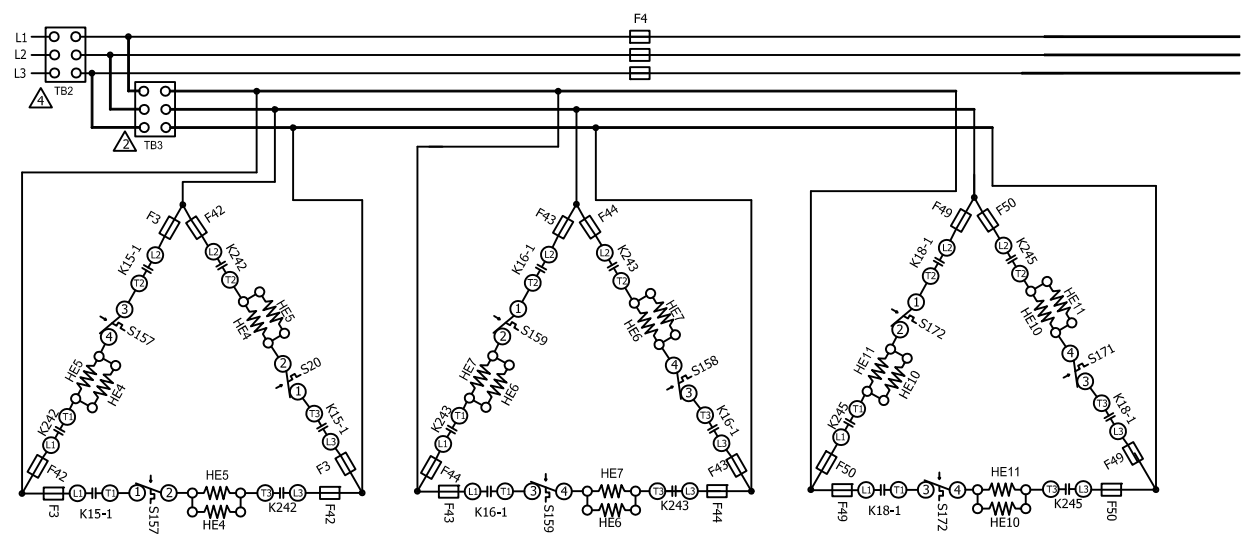
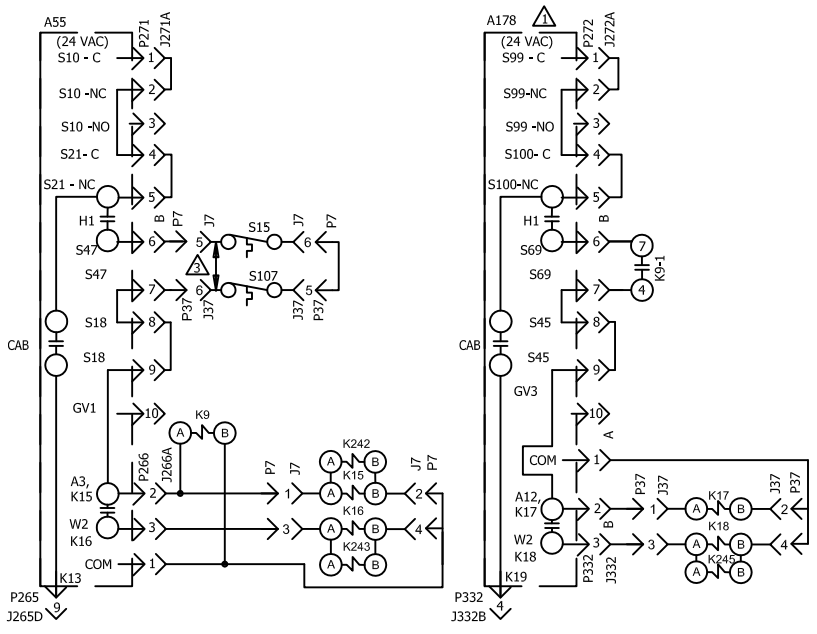

DESIGNATION	VOLTAGE
Y	208-230/60/3

C UNITS 156 TO 300

NOT USED ON 15 AND 30KW UNITS  
 TB3 IS USED IN SOME UNITS  
 REMOVE PLUG WHEN FIELD INSTALLING ELECTRIC HEAT  
 TB2, CB10 OR S48 MAY BE USED

← DENOTES OPTIONAL COMPONENTS

KW	HE1	HE2	HE3	HE4	HE5	HE6	HE7	HE10	HE11	HE12	HE13	HE14
15	7.5	7.5										
30				15	15							
45	15									7.5	15	7.5
60	15									15	15	15
90	15		15			15	15	15	15			

12/14		WIRING DIAGRAM	12/14
		537755-01	
HEATING			
ELECTRIC HEAT FOR EMERGENCY E1EH, EHA - 15, 30, 45, 60, 90 - Y			
SECTION A			REV 0
Supersedes		New Form No. 537755-01	