

NOTE- FOR USE WITH COPPER CONDUCTORS ONLY. REFER TO UNIT RATING PLATE FOR MINIMUM CIRCUIT AMPACITY AND MAXIMUM OVERCURRENT PROTECTION SIZE

REFER TO COMPRESSOR IN UNIT FOR ACTUAL TERMINAL ARRANGEMENT

WARNING-ELECTRIC SHOCK HAZARD CAN CAUSE INJURY OR DEATH. UNIT MUST BE GROUNDED IN ACCORDANCE WITH NATIONAL AND LOCAL CODES

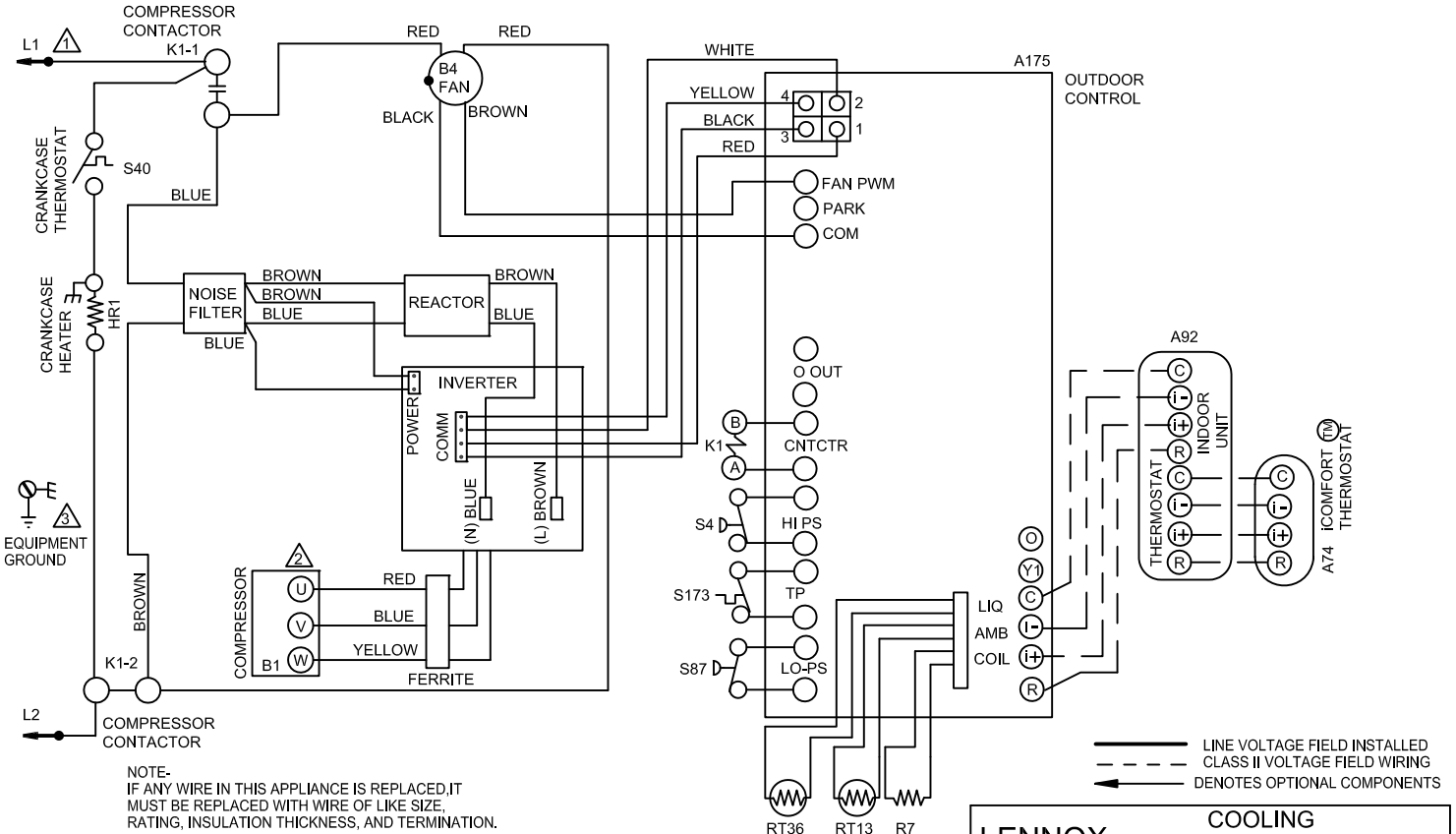

NOTE- IF ANY WIRE IN THIS APPLIANCE IS REPLACED, IT MUST BE REPLACED WITH WIRE OF LIKE SIZE, RATING, INSULATION THICKNESS, AND TERMINATION.

— LINE VOLTAGE FIELD INSTALLED
 - - - CLASS II VOLTAGE FIELD WIRING
 ← DENOTES OPTIONAL COMPONENTS

LENNOX	
COOLING CONDENSING	
XC20-048, -060	
Supersedes	
1114	Form No. 537794-01