



VARIABLE REFRIGERANT FLOW SYSTEMS

VRF

V8OD, V8MS, V8ID

Branch Pipe and Piping Selection for VRA and VPA Systems

Bulletin No. 210717

June 2015

Supersedes September 2014

PRODUCT SPECIFICATIONS

FEATURES

- Constructed of durable copper.
- Insulation material set furnished for each branch joint connection.
- Three types of branch pipes are available.
 - Outdoor Branch Pipe for connecting multiple outdoor units to the main refrigerant piping.
 - Branch Pipe for connecting the main refrigerant piping to the Mode Selection Box (MS) for VRA Heat Recovery Units.
 - Indoor Branch Pipe for connecting the Mode Selection Box (MS) to the indoor units (VRA Heat Recovery Units) or connecting outdoor unit pipe and indoor units (VPA Heat Pumps).

CONTENTS

Branch Pipe For Indoor Units	4
Branch Pipe For Mode Selection Box (MS).	3
Branch Pipe For Outdoor Units	2
Branch Pipe Usage	1
Refrigerant Piping Details - VRA Heat Recovery Units	5
Refrigerant Piping Selection - VPA Heat Pumps . . .	8
Refrigerant Piping Selection - VRA Heat Recovery	6

BRANCH PIPE USAGE

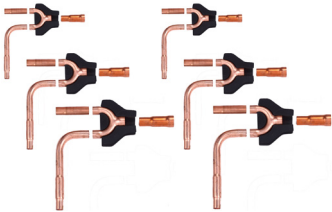
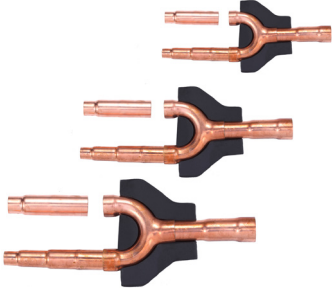
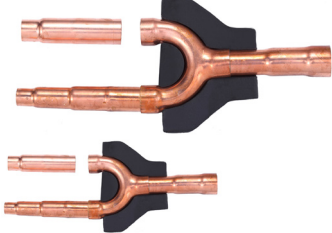
Model No.	Catalog No.	Description	Usage
V8ODBP02HR	12A37	Outdoor Branch Pipe 	For 2 module VRA Heat Recovery combinations
V8ODBP03HR	12A38		For 3 module VRA Heat Recovery combinations
V8ODBP02HP	11H76		For 2 module VPA Heat Pump Outdoor Unit combinations
V8ODBP03HP	11H77		For 3 module VPA Heat Pump Outdoor Unit combinations
V8MSBP01	12A40	Mode Selection Box (MS) Branch Pipe (VRA Heat Recovery Units only) 	Branch pipe between Outdoor Unit pipe and Mode Selection Box (MS) for VRA Heat Recovery Units only
V8MSBP02	12A41		
V8MSBP03	12A42		
V8MSBP04	12A43		
V8MSBP05	12A44		
V8IDBP01	12A45	Indoor Branch Pipe 	Indoor Branch Pipe between Mode Selection Box (MS) and Indoor Units (VRA Heat Recovery Units) or connecting outdoor unit pipe and indoor units (VPA Heat Pumps)
V8IDBP02	12A46		
V8IDBP03	12A47		
V8IDBP04	12A48		
V8IDBP05	12A49		

BRANCH PIPE FOR OUTDOOR UNITS



VRA HEAT RECOVERY UNITS

Name	Low-Pressure Gas Side Joints (inch)	High-Pressure Gas Side Joints (inch)	Liquid Side Joints (inch)	Gas Balance Joint (inch)	Oil Balance Joint (inch)	Insulation Material (furnished)
V80DBP02HR						(3 sets)
V80DBP03HR				N ID: 3/4 ID: 3/4	P ID: 1/4	(6 sets)

VPA HEAT PUMP UNITS

Name	Low-Pressure Gas Side Joints (inch)	Liquid Side Joints (inch)	High-Pressure Gas Balance Joint (inch)	Low-Pressure Gas Balance Joint (inch)	High-Pressure Gas Balance Joint (inch)	Insulation Material (furnished)
V80DBP02HP						(2 sets)
V80DBP03HP			M ID: 7/8 ID: 3/4	N ID: 3/4	P ID: 1/4	(4 sets)

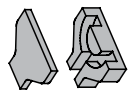
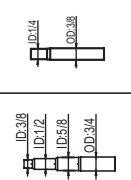
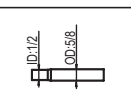
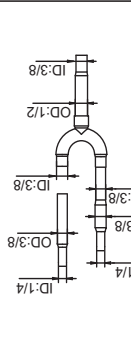
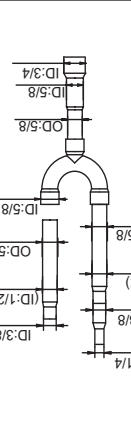
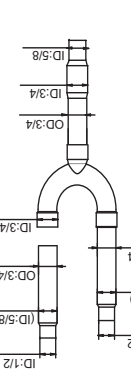
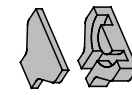
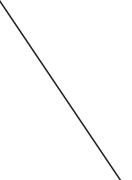
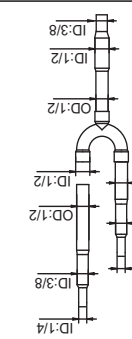
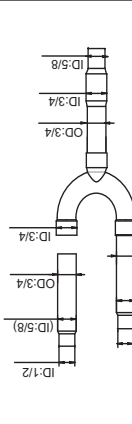
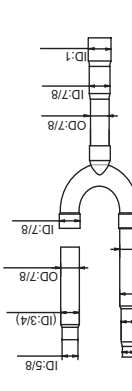
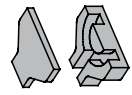
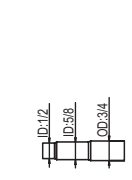
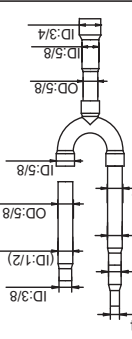
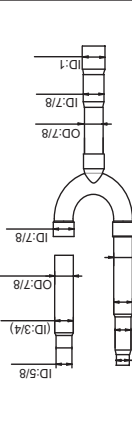
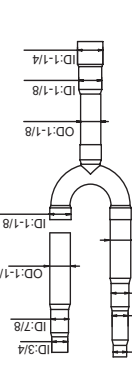
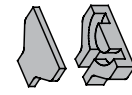
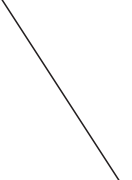
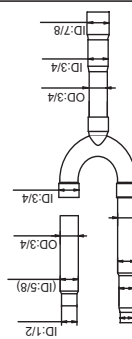
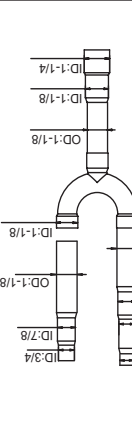
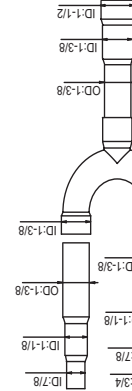
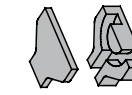
BRANCH PIPE FOR MODE SELECTION BOX (MS)

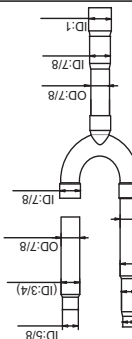
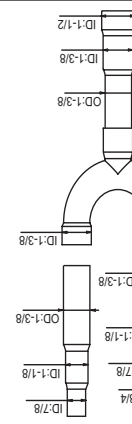
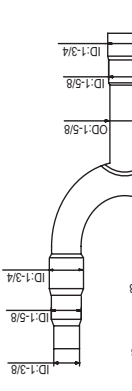
	Insulation Material (furnished)	Adapter Pipe - Inch	Liquid Side Joints - Inch	High-Pressure Gas Side Joints - Inch	Low-Pressure Gas Side Joints - Inch
V8MSBP01	 <p>(3 sets)</p>	 <p>(High-pressure side used)</p>  <p>(Low-pressure side used)</p>			
V8MSBP02	 <p>(3 sets)</p>	 <p>(Liquid side used)</p>			
V8MSBP03	 <p>(3 sets)</p>	 <p>(Liquid side used)</p>			
V8MSBP04	 <p>(3 sets)</p>	 <p>(Liquid side used)</p>			
V8MSBP05	 <p>(3 sets)</p>	 <p>(Liquid side used)</p>			

BRANCH PIPE FOR INDOOR UNITS

Name	Gas Side Joints (inch)	Liquid Side Joints (inch)	Insulation Material (furnished)
V8IDBP01			<p>(2 sets)</p>
V8IDBP02			<p>(2 sets)</p>
V8IDBP03			<p>(2 sets)</p>
V8IDBP04			<p>(2 sets)</p>
V8IDBP05			<p>(2 sets)</p>

REFRIGERANT PIPING DETAILS - VRA HEAT RECOVERY UNITS

Maximum Permitted Refrigerant Pipe Length and Maximum Height Difference

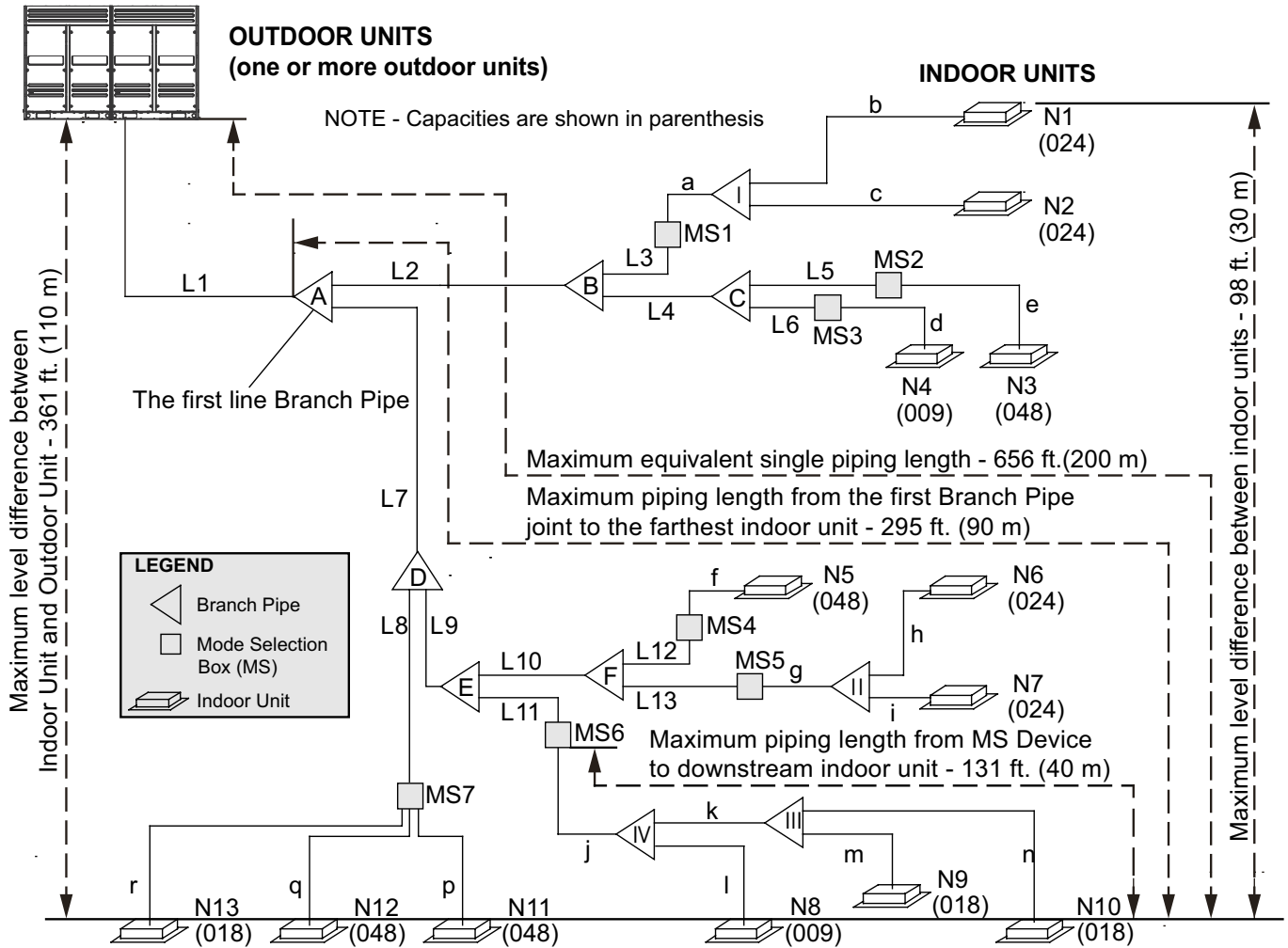

Piping Length		Permitted value	Piping	
Piping Length	Total piping length	¹ 3280 ft. (1000 m)	$L1+(L2+L3+L4+L5+L6+L7+L8+L9+L10+L11+L12+L13) \times 2+a+b+c+d+e+f+g+h+i+j+k+l+m+n+p+q+r$	
	Single piping length	Actual length	574 ft. (175 m)	
		Equivalent length	² 656 ft. (200 m)	
	Piping length from the first branch joint to the farthest indoor unit	³ 132/295 ft. (40/90 m)	$L7+L9+L11+j+k+n$	
Piping length from Mode Selection Box (MS) to the downstream indoor unit of itself	132 ft. (40 m)	$j+k+n$		
Level Difference	Level difference between indoor unit and outdoor unit	Outdoor unit up	⁴ 230 ft. (70 m)	---
		Outdoor unit down	360 ft. (110 m)	---
	Level difference between indoor units	98 ft. (30 m)	---	

NOTES:

The indoor units must be installed as close to equal as possible on both sides of the Branch Pipe joint.

¹ When counting the total piping length, double the actual length of the distribution pipes between first Branch Pipe joint and Mode Selection Box (MS): Installation.
Total piping length = $L1+(L2+L3+L4+L5+L6+L7+L8+L9+L10+L11+L12+L13) \times 2+a+b+c+d+e+f+g+h+i+j+k+l+m+n+p+q+r \leq 3280 \text{ ft. (1000 m)}$.

² Each Branch Pipe is equivalent to 20 in. (508 mm).

³ The maximum allowable piping length from the first Branch Pipe joint to the farthest indoor unit must be $\leq 132 \text{ ft. (40 m)}$, but if the following conditions are met, the maximum allowable length can be extended to 295 ft. (90 m):

- The piping length from each indoor unit to the nearest Branch Pipe joint or direct connected Mode Selection Box (MS) must be less than 132 ft. (40m) (b to r).
- The difference in length between the outdoor unit to the farthest indoor unit, and the outdoor unit to the nearest indoor unit is $\leq 132 \text{ ft. (40 m)}$.

Example: The farthest indoor unit is N10, The nearest indoor unit is N11 ($L1+L7+L9+L11+j+k+n$) minus ($L1+L7+L8+p$) $\leq 132 \text{ ft. (40 m)}$.

- Increase the distribution pipe diameter between the first Branch Pipe and Mode Selection Box (MS) L2-L13. If the pipe diameter is the same as the main outdoor pipe, it does not need to be increased.

Pipe Size Allowable Increase Diameters (in.):

3/8 to 1/2	1/2 to 5/8	5/8 to 3/4	3/4 to 7/8	7/8 to 1-1/8	1-1/8 to 1-3/8	1-3/8 to 1-5/8	1-5/8 to 2-1/8
------------	------------	------------	------------	--------------	----------------	----------------	----------------

⁴ When the outdoor unit is higher than indoor units and the level difference is over 65.6 ft. (20 m), it is recommended to set an oil return bend every 32.8 ft. (10 m) in the gas pipe of the main pipe. Refer to Installation Instructions for additional details.

⁵ When the outdoor unit is lower than indoor units and the level difference is more than 132 ft. (40 m), the main liquid pipe pipe need to increase by one size.

REFRIGERANT PIPING SELECTION - VRA HEAT RECOVERY

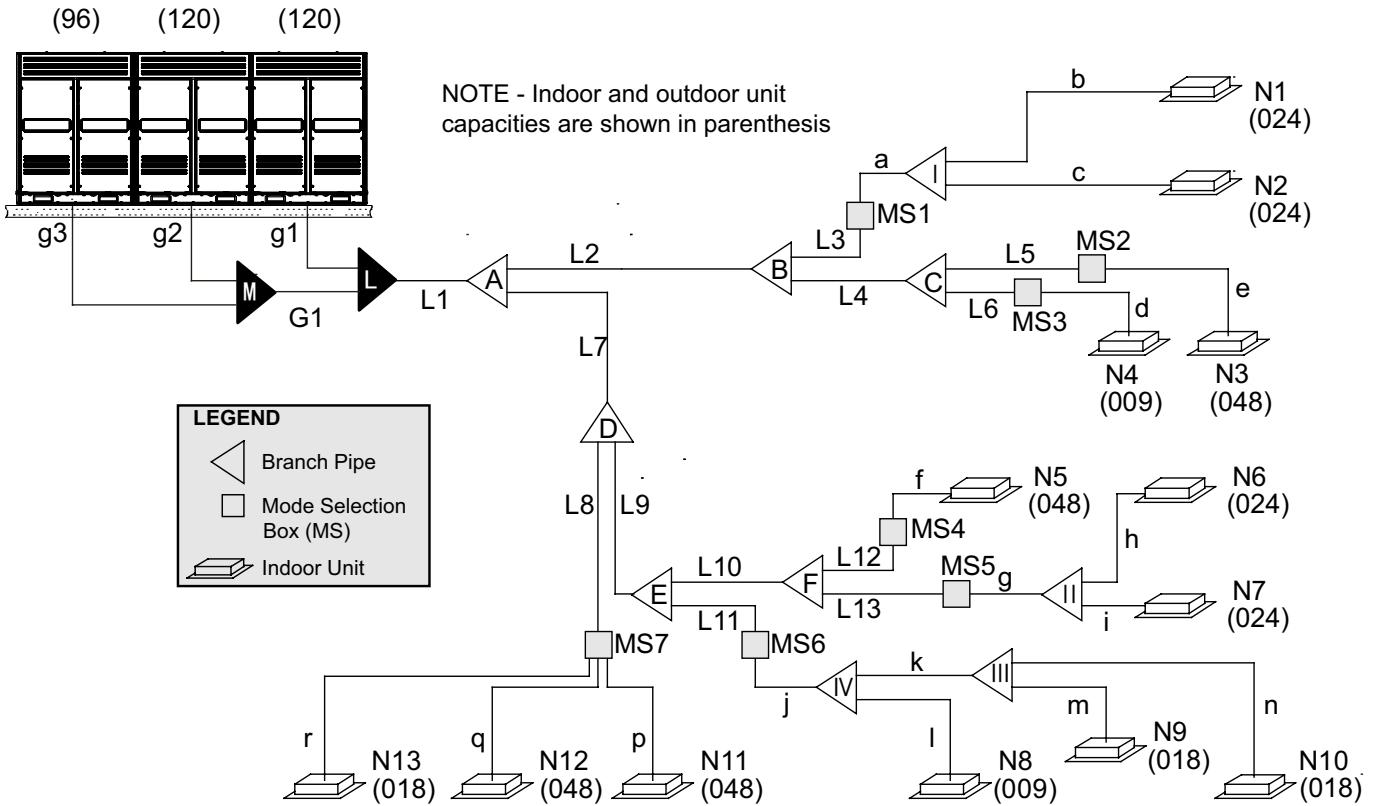

PIPE AND COMPONENT NAMES

Name	Designation
Outdoor Unit Connection Pipe	g1, g2, g3, G1
Outdoor Unit Branch Pipe Assembly	L, M
Main Pipe	L1
Indoor Unit Main Pipe	L2, L3, L4, L5, L6, L7, L8, L9, L10, L11, L12, L13
Branch Pipe Assembly between Main Pipe and Mode Selection Box (MS)	A, B, C, D, E, F
Mode Selection Box (MS)	MS1, MS2, MS3, etc.
Branch Pipe Assembly between Mode Selection Box (MS) and Indoor Unit	I, II, III, IV
Indoor Unit auxiliary pipe between Mode Selection Box (MS) and downstream Branch Pipe joint	a, g, j, k
Indoor Unit auxiliary pipe from Indoor Unit to the nearest Branch Pipe joint or direct connected Mode Selection Box (MS)	b, c, d, e, f, h, i, l, m, n, p, q, r
Indoor Unit	N1, N2, N3, etc.

REFRIGERANT PIPING SELECTION - VRA HEAT RECOVERY

OUTDOOR UNIT MAIN PIPE SELECTION (L1)

Outdoor Unit Size	Main Pipe Diameter (in.)							First Branch Pipe Assembly
	Equivalent length of all liquid pipes is <u>less</u> than 295 ft. (90 m)			First Branch Pipe Assembly	Equivalent length of all liquid pipes is <u>more</u> than 295 ft. (90 m)			
	Low Pressure Gas Pipe	High Pressure Gas Pipe	Liquid Pipe		Low Pressure Gas Pipe	High Pressure Gas Pipe	Liquid Pipe	
072	7/8	3/4	3/8	V8MSBP02	7/8	3/4	1/2	V8MSBP02
096	7/8	3/4	1/2	V8MSBP02	7/8	3/4	1/2	V8MSBP02
120	1-1/8	3/4	1/2	V8MSBP03	1-1/8	3/4	5/8	V8MSBP03
144-145	1-1/8	7/8	5/8	V8MSBP03	1-1/8	7/8	5/8	V8MSBP03
168-216	1-3/8	1-1/8	5/8	V8MSBP04	1-3/8	1-1/8	3/4	V8MSBP04
240	1-3/8	1-1/8	5/8	V8MSBP04	1-3/8	1-1/8	3/4	V8MSBP04
264-312	1-3/8	1-1/8	3/4	V8MSBP04	1-3/8	1-1/8	7/8	V8MSBP04
336-432	1-5/8	1-3/8	3/4	V8MSBP05	1-5/8	1-3/8	7/8	V8MSBP05

Note - The Main Pipe (L1) can be selected from the Outdoor Unit Main Pipe Selection table or the Indoor Unit Main Pipe Selection table, the larger size must be used.

INDOOR UNIT MAIN PIPE SELECTION (L1 to L13)

Indoor Unit Total Capacity (kBtuh)	Indoor Unit Main Pipe Diameter (in.)			Branch Pipe Assembly
	Low Pressure Gas Pipe	High Pressure Gas Pipe	Liquid Pipe	
A < 018	1/2	3/8	1/4	V8MSBP01
018 ≤ A < 056	3/4	5/8	3/8	V8MSBP01
056 ≤ A < 078	7/8	3/4	3/8	V8MSBP02
078 ≤ A < 112	7/8	3/4	1/2	V8MSBP02
112 ≤ A < 156	1-1/8	7/8	1/2	V8MSBP03
156 ≤ A < 224	1-1/8	7/8	5/8	V8MSBP03
224 ≤ A < 314	1-3/8	1-1/8	3/4	V8MSBP04
314 ≤ A < 460	1-5/8	1-3/8	3/4	V8MSBP05
≤ 460	1-5/8	1-3/8	7/8	V8MSBP05

OUTDOOR UNIT PIPE SELECTION (g1, g2, g3, G1)

Pipe	Outdoor Unit Size	Pipe Diameter (in.)		
		Low Pressure Gas Pipe	High Pressure Gas Pipe	Liquid Pipe
g1, g2, g3	6 or 8 ton	7/8	3/4	1/2
	10 or 12 ton	1-1/8	3/4	5/8
G1	---	1-3/8	1-1/8	3/4

OUTDOOR UNIT BRANCH PIPE ASSEMBLY SELECTION (L, M)

Outdoor Unit Quantity	Parallel Connection with Branch Pipes
2 units	L use V8ODBP02HR
3 units	L + M use V8ODBP03HR

INDOOR UNIT AUXILIARY PIPE SELECTION (Between Branch Box (MS) And Downstream Branch Joint) (a, g, j, k)

Indoor Unit Capacity (kBtuh)	Pipe Diameter (in.)		Available Branch Pipe
	Gas Pipe	Liquid Pipe	
A<56	5/8	3/8	V8IDBP01

INDOOR UNIT AUXILIARY PIPE SELECTION

(From Indoor Unit To The Nearest Branch Joint Or Direct Connected Mode Selection Box (MS) (b, c, d, e, f, h, i, l, m, n, p, q, r)

Indoor Unit Capacity (kBtuh)	Pipe Diameter (in.)			
	Pipe length from indoor unit to nearest branch joint or direct connected Mode Selection Box (MS) Pipe length <u>less</u> than 33 ft (10 m)		Pipe length <u>more</u> than 33 ft (10 m)	
	Gas Pipe	Liquid Pipe	Gas Pipe	Gas Pipe
A<18	1/2	1/4	5/8	3/8
18≤A<54	5/8	3/8	3/4	1/2

REFRIGERANT PIPING SELECTION - VPA HEAT PUMPS

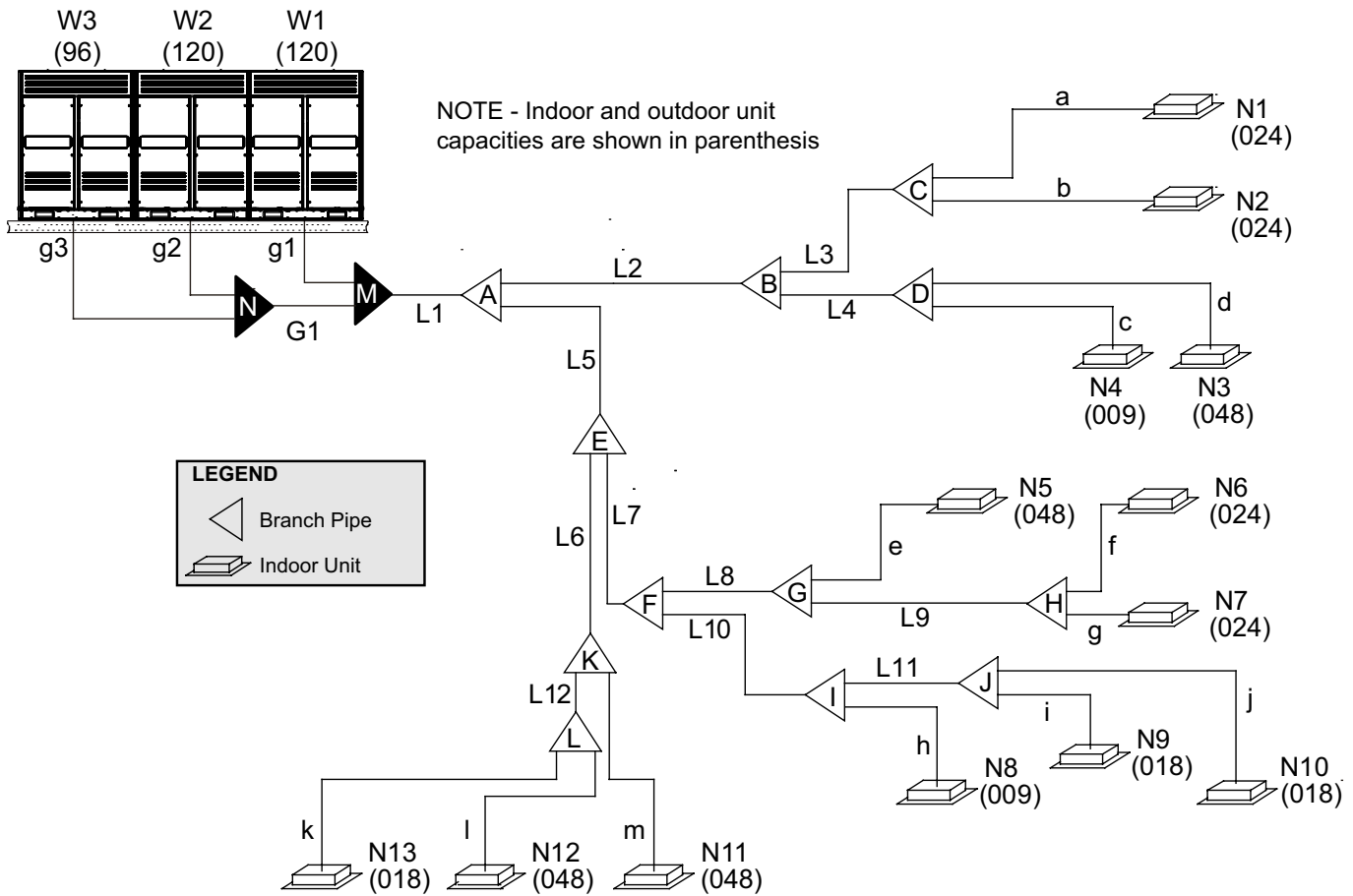

PIPE AND COMPONENT NAMES

Name	Designation
Outdoor Unit Connection Pipe	g1, g2, g3, G1
Outdoor Unit Branch Pipe Assembly	M, N
Main Pipe	L1
Indoor Unit Main Pipe	L2, L3, L4, L5, L6, L7, L8, L9, L10, L11, L12
Branch Pipe Assembly	A, B, C, D, E, F, G, H, I, J, K, L
Indoor Unit auxiliary pipe from Indoor Unit to the nearest Branch Pipe joint	a, b, c, d, e, f, g, h, i, j, k, l, m
Indoor Unit	N1, N2, N3, etc.

REFRIGERANT PIPING SELECTION - HEAT PUMPS

OUTDOOR UNIT MAIN PIPE SELECTION (L1)

Outdoor Unit Size	Main Pipe Diameter (in.)					First Branch Pipe Assembly
	Equivalent length of all liquid pipes is <u>less</u> than 295 ft. (90 m)		First Branch Pipe Assembly	Equivalent length of all liquid pipes is <u>more</u> than 295 ft. (90 m)		
	Low Pressure Gas Pipe	Liquid Pipe		Low Pressure Gas Pipe	Liquid Pipe	
072	7/8	3/8	V8IDBP02	7/8	1/2	V8IDBP02
096	7/8	3/8	V8IDBP02	1-1/8	1/2	V8IDBP03
120	1-1/8	1/2	V8IDBP03	1-1/8	5/8	V8IDBP03
144-145	1-1/8	1/2	V8IDBP03	1-1/8	5/8	V8IDBP03
168-216	1-1/8	5/8	V8IDBP03	1-3/8	3/4	V8IDBP04
240	1-1/8	5/8	V8IDBP03	1-3/8	3/4	V8IDBP04
264-312	1-3/8	3/4	V8IDBP04	1-3/8	7/8	V8IDBP04
336-432	1-3/8	3/4	V8IDBP04	1-5/8	7/8	V8IDBP05

Note - The Main Pipe (L1) can be selected from the Outdoor Unit Main Pipe Selection table or the Indoor Unit Main Pipe Selection table, the larger size must be used.

INDOOR UNIT MAIN PIPE SELECTION (L1 to L12)

Indoor Unit Total Capacity (kBtuh)	Indoor Unit Main Pipe Diameter (in.)		Branch Pipe Assembly
	Gas Pipe	Liquid Pipe	
A < 056	5/8	3/8	V8IDBP01
056 ≤ A < 078	3/4	3/8	V8IDBP01
078 ≤ A < 112	7/8	3/8	V8IDBP02
112 ≤ A < 156	1-1/8	1/2	V8IDBP03
156 ≤ A < 224	1-1/8	5/8	V8IDBP03
224 ≤ A < 314	1-3/8	3/4	V8IDBP04
314 ≤ A < 460	1-5/8	3/4	V8IDBP05
≤ 460	1-5/8	7/8	V8IDBP05

OUTDOOR UNIT PIPE SELECTION (g1, g2, g3, G1)

Pipe	Outdoor Unit Size	Pipe Diameter (in.)	
		Low Pressure Gas Pipe	Liquid Pipe
g1, g2, g3	6 or 8 ton	7/8	1/2
	10 or 12 ton	1-1/8	5/8
G1	- - -	1-3/8	3/4

OUTDOOR UNIT BRANCH PIPE ASSEMBLY SELECTION (M, N)

Outdoor Unit Quantity	Parallel Connection with Branch Pipes
2 units	M use V8ODBP02HP
3 units	M + N use V8ODBP03HP

INDOOR UNIT AUXILIARY PIPE SELECTION

(From Indoor Unit To The Nearest Branch Joint (a, b, c, d, e, f, g, h, i, j, k, l, m))

Indoor Unit Capacity (kBtuh)	Pipe Diameter (in.)			
	Pipe length from indoor unit to nearest branch joint			
	Pipe length <u>less</u> than 33 ft (10 m)		Pipe length <u>more</u> than 33 ft (10 m)	
	Gas Pipe	Liquid Pipe	Gas Pipe	Gas Pipe
A < 18	1/2	1/4	5/8	3/8
18 ≤ A < 54	5/8	3/8	3/4	1/2

REVISIONS

Sections	Description of Change
Refrigerant Piping Selection	Added new system combinations.



Visit us at www.lennox.com

For the latest technical information, www.lennoxcommercial.com

Contact us at 1-800-4-LENNOX

NOTE - Due to Lennox' ongoing commitment to quality, Specifications, Ratings and Dimensions subject to change without notice and without incurring liability. Improper installation, adjustment, alteration, service or maintenance can cause property damage or personal injury. Installation and service must be performed by a qualified installer and servicing agency.

©2015 Lennox Industries, Inc.