

iComfort® ENABLED SL280UHV(X) SERIES UNITS

SL280UHV(X) series units are 80% efficiency gas furnaces used for upflow or horizontal applications only, manufactured with Lennox Duralok™ heat exchangers formed of aluminized steel. SL280UHV(X) units are available in heating capacities of 66,000 to 132,000 Btuh and cooling applications up to 5 tons. Refer to Engineering Handbook for proper sizing.

Units are factory equipped for use with natural gas. Kits are available for conversion to LPG operation. SL280UHV(X) model units are equipped with the iComfort® enabled SureLight® two-stage variable speed integrated control. SL280UHV(X) unit meets the California Nitrogen Oxides (NO_x) Standards and California Seasonal Efficiency requirements. All units use a redundant gas valve to assure safety shut-off as required by C.S.A.

All specifications in this manual are subject to change. Procedures outlined in this manual are presented as a recommendation only and do not supersede or replace local or state codes. In the absence of local or state codes, the guidelines and procedures outlined in this manual (except where noted) are recommendations only and do not constitute code.



TABLE OF CONTENTS

Specifications Page 2
 I Unit Components Page 5
 II Installation Page 43
 III Start Up Page 43
 IV Heating System Service Checks Page 44
 V Typical Operating Characteristics Page 47
 VI Maintenance Page 48
 VII Wiring and Sequence of Operation Page 51
 VIII Field Wiring and Jumper Settings Page 55
 IX Program Unit Capacity Size Mode Page 59
 X Troubleshooting Page 60

⚠ WARNING

Improper installation, adjustment, alteration, service or maintenance can cause property damage, personal injury or loss of life. Installation and service must be performed by a licensed professional HVAC installer (or equivalent), service agency or the gas supplier.

⚠ CAUTION

As with any mechanical equipment, contact with sharp sheet metal edges can result in personal injury. Take care while handling this equipment and wear gloves and protective clothing.

SPECIFICATIONS

Gas Heating Performance	Model No.	SL280UH070V36A	SL280UH090V36B	SL280UH090V48B
	Model No. - Low Nox	SL280UH070XV36A	- - -	SL280UH090XV48B
	¹ AFUE	80%	80%	80%
High Fire	Input - Btuh	66,000	88,000	88,000
	Output - Btuh	52,000	70,000	70,000
	Temperature rise range - °F	40 - 70	40 - 70	40 - 70
	Gas Manifold Pressure (in. w.g.) Nat. Gas / LPG/Propane	3.5 / 10	3.5 / 10	3.5 / 10
Low Fire	Input - Btuh	43,000	57,000	57,000
	Output - Btuh	35,000	47,000	47,000
	Temperature rise range - °F	25 -55	25 -55	25 -55
	Gas Manifold Pressure (in. w.g.) Nat. Gas / LPG/Propane	1.7 / 4.9	1.7 / 4.9	1.7 / 4.9
High static - in. w.g.	Heating	0.8	0.8	0.8
	Cooling	1.0	1.0	1.0
Connections in.	Flue connection - in. round	4	4	4
	Gas pipe size IPS	1/2	1/2	1/2
Indoor Blower	Wheel nominal diameter x width - in.	10 X 8	10 X 9	11-1/2 X 9
	Motor output - hp	1/2	1/2	1.0
	Tons of add-on cooling	2 - 3	2 - 3.5	2.5 - 4
	Air Volume Range - cfm	606 - 1345	498 - 1393	679 - 2002
Electrical Data	Voltage	120 volts - 60 hertz - 1 phase		
	Blower motor full load amps	7.7	7.7	12.8
	Maximum overcurrent protection	15	15	20
Shipping Data	lbs. - 1 package	128	143	154

NOTE - Filters and provisions for mounting are not furnished and must be field provided.

¹ Annual Fuel Utilization Efficiency based on DOE test procedures and according to FTC labeling regulations. Isolated combustion system rating for non-weatherized furnaces.

² Flue connection on the unit is 4 in. diameter. Most applications will require 5 in. venting and field supplied 4 x 5 in. adaptor. See Venting Tables in the Installation Instructions for detailed information.

SPECIFICATIONS

Gas Heating Performance	Model No.	SL280UH090V60C	SL280UH110V60C	SL280UH135V60D
	Model No. - Low Nox	- - -	SL280UH110XV60C	- - -
	¹ AFUE	80%	80%	80%
High Fire	Input - Btuh	88,000	110,000	132,000
	Output - Btuh	70,000	87,000	105,000
	Temperature rise range - °F	35 - 65	35 - 65	40 - 70
	Gas Manifold Pressure (in. w.g.) Nat. Gas / LPG/Propane	3.5 / 10.0	3.5 / 10.0	3.5 / 10.0
Low Fire	Input - Btuh	57,000	71,500	85,800
	Output - Btuh	47,000	58,000	69,000
	Temperature rise range - °F	25 -55	25 -55	25 -55
	Gas Manifold Pressure (in. w.g.) Nat. Gas / LPG/Propane	1.7 / 4.9	1.7 / 4.9	1.7 / 4.9
High static - in. w.g.	Heating	0.8	0.8	0.8
	Cooling	1.0	1.0	1.0
Connections in.	Flue connection - in. round	4	4	² 4
	Gas pipe size IPS	1/2	1/2	1/2
Indoor Blower	Wheel nominal diameter x width - in.	11-1/2 X 10	11-1/2 X 10	11-1/2 X 11
	Motor output - hp	1.0	1.0	1.0
	Tons of add-on cooling	3 - 5	3 - 5	3.5 - 5
	Air Volume Range - cfm	826 - 2305	812 - 2125	828 - 2257
Electrical Data	Voltage	120 volts - 60 hertz - 1 phase		
	Blower motor full load amps	12.8	12.8	12.8
	Maximum overcurrent protection	20	20	20
Shipping Data	lbs. - 1 package	173	181	199

NOTE - Filters and provisions for mounting are not furnished and must be field provided.

¹ Annual Fuel Utilization Efficiency based on DOE test procedures and according to FTC labeling regulations. Isolated combustion system rating for non-weatherized furnaces.

² Flue connection on the unit is 4 in. diameter. Most applications will require 5 in. venting and field supplied 4 x 5 in. adaptor. See Venting Tables in the Installation Instructions for detailed information.

OPTIONAL ACCESSORIES - MUST BE ORDERED EXTRA

		"A" Width Models	"B" Width Models	"C" Width Models	"D" Width Models	
CABINET ACCESSORIES						
Horizontal Suspension Kit - Horizontal only		51W10	51W10	51W10	51W10	
Return Air Base - Upflow only		65W75	50W98	50W99	51W00	
CONTROLS						
ComfortSense® 7000 Thermostat		Y0349	Y0349	Y0349	Y0349	
Remote Outdoor Sensor (for dual fuel and Humiidtrol®)		X2658	X2658	X2658	X2658	
FILTERS						
¹ Air Filter and Rack Kit	Horizontal (end)	87L95	87L96	87L97	87L98	
	Size of filter - in.	14 x 25 x 1	18 x 25 x 1	20 x 25 x 1	25 x 25 x 1	
	Side Return	Single	44J22	44J22	44J22	44J22
		Ten Pack	66K63	66K63	66K63	66K63
	Size of filter - in.	16 x 25 x 1	16 x 25 x 1	16 x 25 x 1	16 x 25 x 1	
NIGHT SERVICE KITS						
Night Service Kit		14C98	14C98	14C98	14C98	
Safety Service Kit		89W19	89W19	89W19	89W19	

¹ Cleanable polyurethane, frame-type filter.

GAS HEAT ACCESSORIES

Input	Natural Gas to LPG/Propane Kit	LPG/Propane to Natural Gas Kit
All models	11K51	11K46

SL280UHV Parts Arrangement

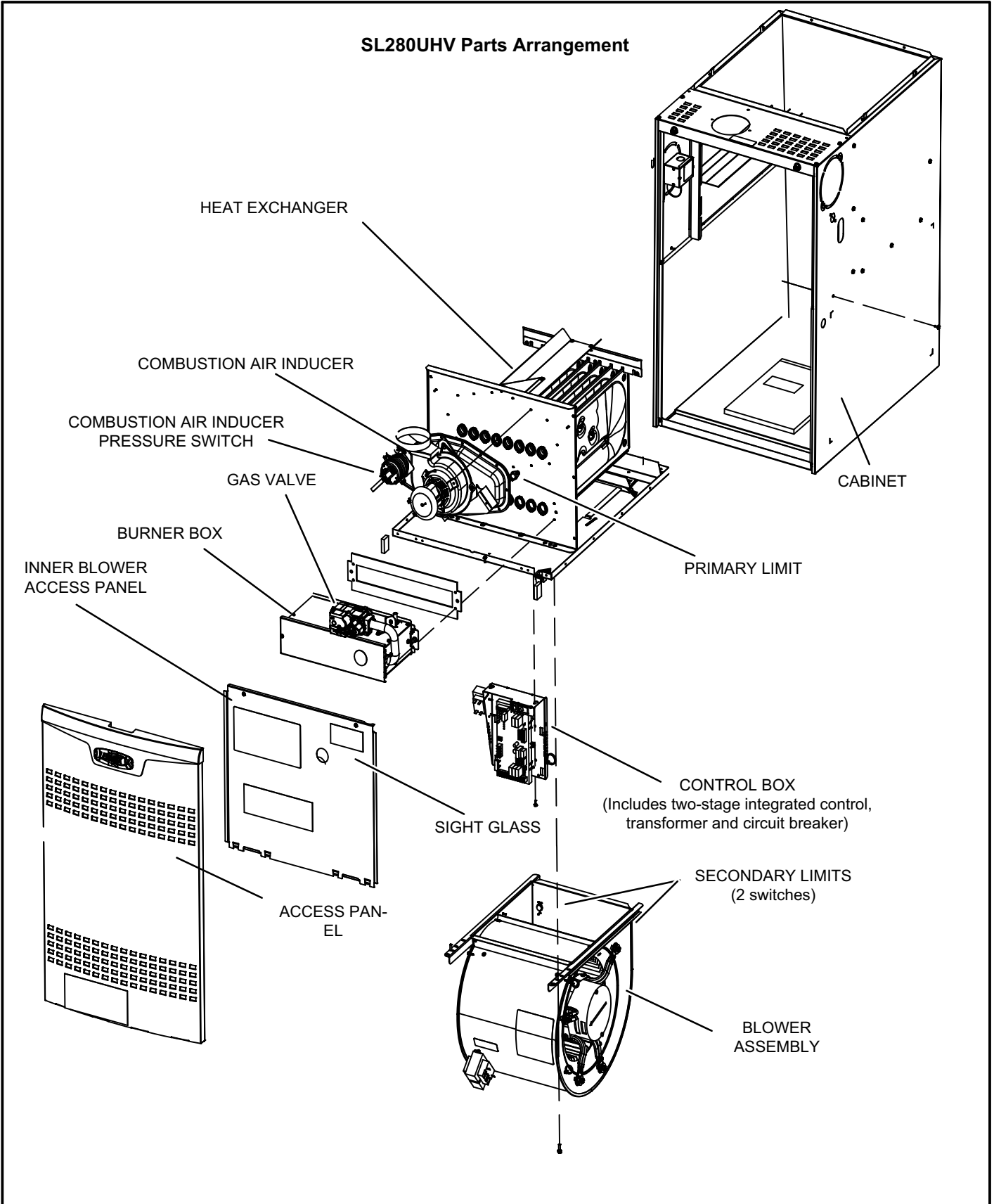
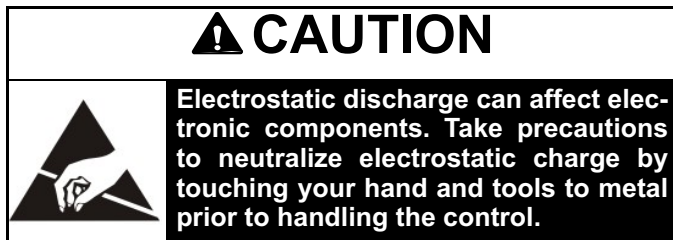

FIGURE 1

I-UNIT COMPONENTS

SL280UHV(X) unit components are shown in figure 1. The gas valve, combustion air inducer and burners can be accessed by removing the access panel. Electrical components are in the control box (figure 2) found in the blower section.

SL280UHV(X) units are factory equipped with a bottom return air panel in place. The panel is designed to be field removed as required for bottom air return. Markings are provided for side return air and may be cut out in the field.



A- Control Box

1. Control Transformer (T1)

A transformer located in the control box provides power to the low voltage section of the unit. Transformers on all models are rated 40VA with a 120V primary and a 24V secondary.

2. Door Interlock Switch (S51)

A door interlock switch rated 14A at 125VAC is wired in series with line voltage. When the inner blower access panel is removed the unit will shut down.

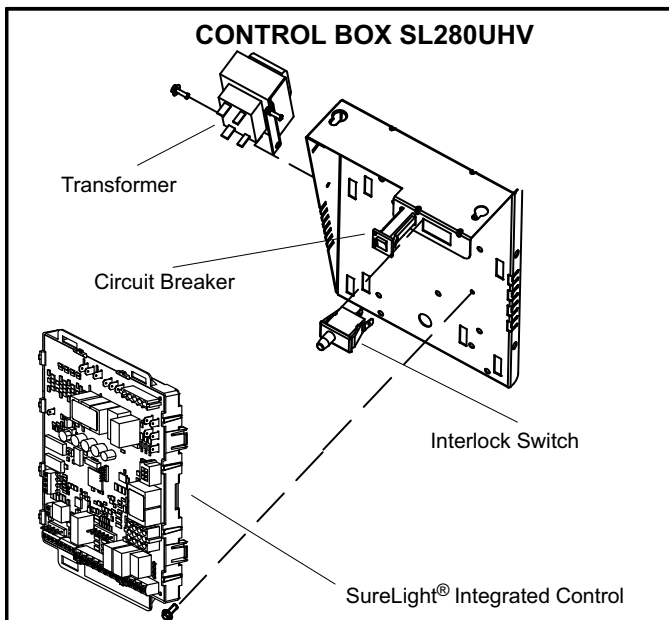

FIGURE 2

3. Circuit Breaker (CB8)

A 24V circuit breaker is also located in the control box. The switch provides overcurrent protection to the transformer (T1). The breaker is rated 3A at 32V. If the current exceeds this limit the breaker will trip and all unit operation will shutdown. The breaker can be manually reset by pressing the button on the face. See figure 3.

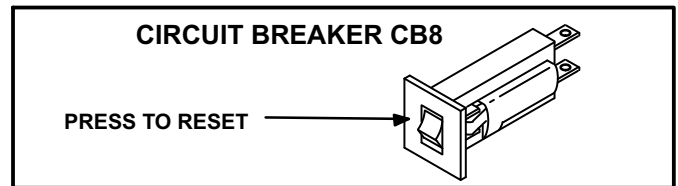

FIGURE 3



4. Integrated Control (A92)

Units are equipped with the icomfort™ enabled SureLight® two-stage, variable speed integrated control. This control is used with the icomfort Wi-Fi® thermostat as part of a communicating comfort system. The control can also operate with a non-communicating conventional single or two-stage thermostat. The system consists of a ignition / blower control (figures 4 and 5) with control pin designations in tables 1, 2 and 3 and ignitor (figure 13). The control and ignitor work in combination to ensure furnace ignition and ignitor durability. The control provides gas ignition, safety checks and indoor blower control with two-stage gas heating. The furnace combustion air inducer, gas valve and indoor blower are controlled in response to various system inputs such as thermostat signal, pressure and limit switch signal and flame signal. The control features a seven-segment LED display, indicating furnace status (including indoor blower) and error codes. The LED flashes in single digits. For example using table 5 under LIMIT CODE, an "E" followed by "2" followed by "5" followed by "0", the limit switch circuit is open. The control also has two unpowered (dry) 1/4" contacts for a humidifier and a 120 volt accessory terminal. Both rated at (1) one amp each.

Electronic Ignition

At the beginning of the heat cycle the integrated control monitors the first stage and second stage combustion air inducer prove switch. The control will not begin the heating cycle if the first stage prove switch is closed (by-passed). Likewise the integrated control will not begin the second stage heating cycle if the second stage prove switch is closed, and will remain in first stage heat. However, if the second stage prove switch closes during the first stage heat pre-purge, the control will allow second stage heat. Once the first stage prove switch is determined to be open,

the combustion air inducer is energized on low (first stage) heat speed. When the differential in the prove switch is great enough, the prove switch closes and a 15-second pre-purge begins.

NOTE - During abnormal conditions such as low supply voltage or low outdoor temperatures and the low fire pressure switch does not close, the combustion air inducer will switch to high fire. After a 15 second pre-purge the high fire pressure switch will close and the unit will begin operation on high fire. After 10 to 20 seconds of high fire operation the unit will switch to low fire.

After the 15-second pre-purge period, the SureLight ignitor warms up for 20 seconds after which the gas valve opens for a 4-second trial for ignition. The ignitor energizes during the trial until flame is sensed. If ignition is not proved during the 4-second period, the control will try four more times with an inter purge and warm-up time between trials of 35 seconds. After a total of five trials for ignition (including the initial trial), the control goes into Watchguard-Flame Failure mode. After a 60-minute reset period, the control will begin the ignition sequence again.

Two Stage Operation / Thermostat Selection DIP Switch

The control can be utilized in two modes: SINGLE-STAGE thermostat or TWO-STAGE thermostat. The thermostat selection is made using a DIP switch and must be positioned for the particular application. DIP switch 1, labeled T^hSTAT HEAT STAGE is factory-set in the OFF position for use with a two-stage thermostat. Move the DIP switch to ON for use with a single stage thermostat.

While in the single-stage thermostat mode, the burners will always fire on first-stage heat. The combustion air inducer will operate on low speed and indoor blower will operate on low heat speed. The unit will switch to second stage heat after a "recognition period". DIP switch 2, labeled SECOND STAGE DELAY, is factory set in the OFF position for a 7 minute recognition period. The switch can be moved to the ON position for a 12 minute recognition period, after which time the unit will switch to second-stage heat.

While in the two-stage thermostat mode (two DIP switch setting) the burners will fire on first-stage heat. The combustion air inducer will operate on low speed and indoor blower will operate on low heat speed. The unit will switch to second-stage heat on call from the indoor thermostat. If there is a simultaneous call for first and second stage heat, the unit will fire an first stage heat and switch to second stage heat after 30 seconds of operation. See Sequence of Operation flow charts in the back of this manual for more detail.

TABLE 1

SureLight® Control 5 Pin Terminal Designation	
PIN #	Function
1	Ignitor
2	Combustion Air Inducer High Speed
3	Combustion Air Inducer Low Speed
4	Combustion Air Inducer Neutral
5	Ignitor Neutral

TABLE 2

SureLight® Control 12 Pin Terminal Designation	
PIN #	Function
1	Gas Valve High Fire
2	Second Stage Prove Switch
3	Rollout In
4	Ground
5	24V Hot
6	Primary Limit In
7	Gas Valve Low Stage
8	Gas Valve Common
9	24V Neutral
10	Ground
11	Rollout Switch Out
12	1st Stage Prove Switch

TABLE 3

SureLight® Control 6 Pin Terminal Designation	
PIN #	Function
1	Data Input From Motor
2	Common
3	Not Used
4	Data Output To Motor
5	5 Volt Bias Supply
6	Not Used

INTEGRATED CONTROL

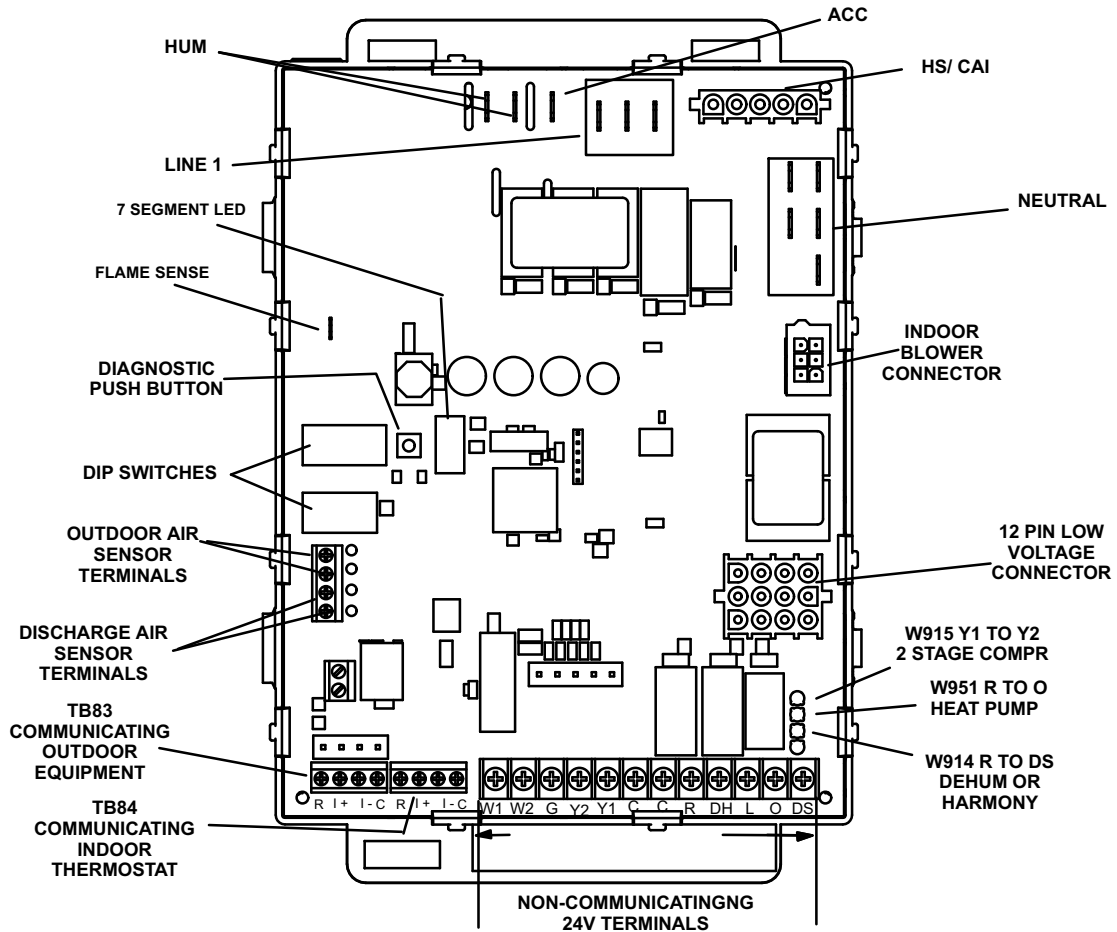

RS-BUS LINK (TB82, future use)

I+ = DATA HIGH CONNECTION
I- = DATA LOW CONNECTION

RS-BUS OUTDOOR (TB83)

R = 24VAC
I+ = DATA HIGH CONNECTION
I- = DATA LOW CONNECTION
C = 24VAC COMMON

RS-BUS INDOOR (TB84)

R = 24VAC
I+ = DATA HIGH CONNECTION
I- = DATA LOW CONNECTION
C = 24VAC COMMON

1/4" QUICK CONNECT TERMINALS

HUM = UNPOWERED NORMALLY OPEN (DRY) CONTACTS
XMFR = 120 VAC OUTPUT TO TRANSFORMER
LI = 120 VAC INPUT TO CONTROL
ACC = 120 VAC OUTPUT TO OPTIONAL ACCESSORY
NEUTRALS = 120 VAC NEUTRAL

THERMOSTAT CONNECTIONS (TB1)

DS = DEHUMIDIFICATION SIGNAL
W2 = HEAT DEMAND FROM 2ND STAGE T/STAT
W1 = HEAT DEMAND FROM 1ST STAGE T/STAT
R = CLASS 2 VOLTAGE TO THERMOSTAT
G = MANUAL FAN FROM T'STAT
C = THERMOSTAT SIGNAL GROUND CONNECTED TO TRANSFORMER GRD (TR) & CHASIS GROUND (GRD)
Y1 = THERMOSTAT 1ST STAGE COOL SIGNAL
Y2 = THERMOSTAT 2ND STAGE COOL SIGNAL
O = THERMOSTAT SIGNAL TO HEAT PUMP REVERSING VALVE
DH = DEHUMIDIFICATION OUTPUT COMMUNICATING THERMOSTAT ONLY
L = USE ONLY WITH A COMMUNICATING THERMOSTAT AND A NON-COMMUNICATING OUTDOOR UNIT

FIGURE 4

INTEGRATED CONTROL CONFIGURATION GUIDE

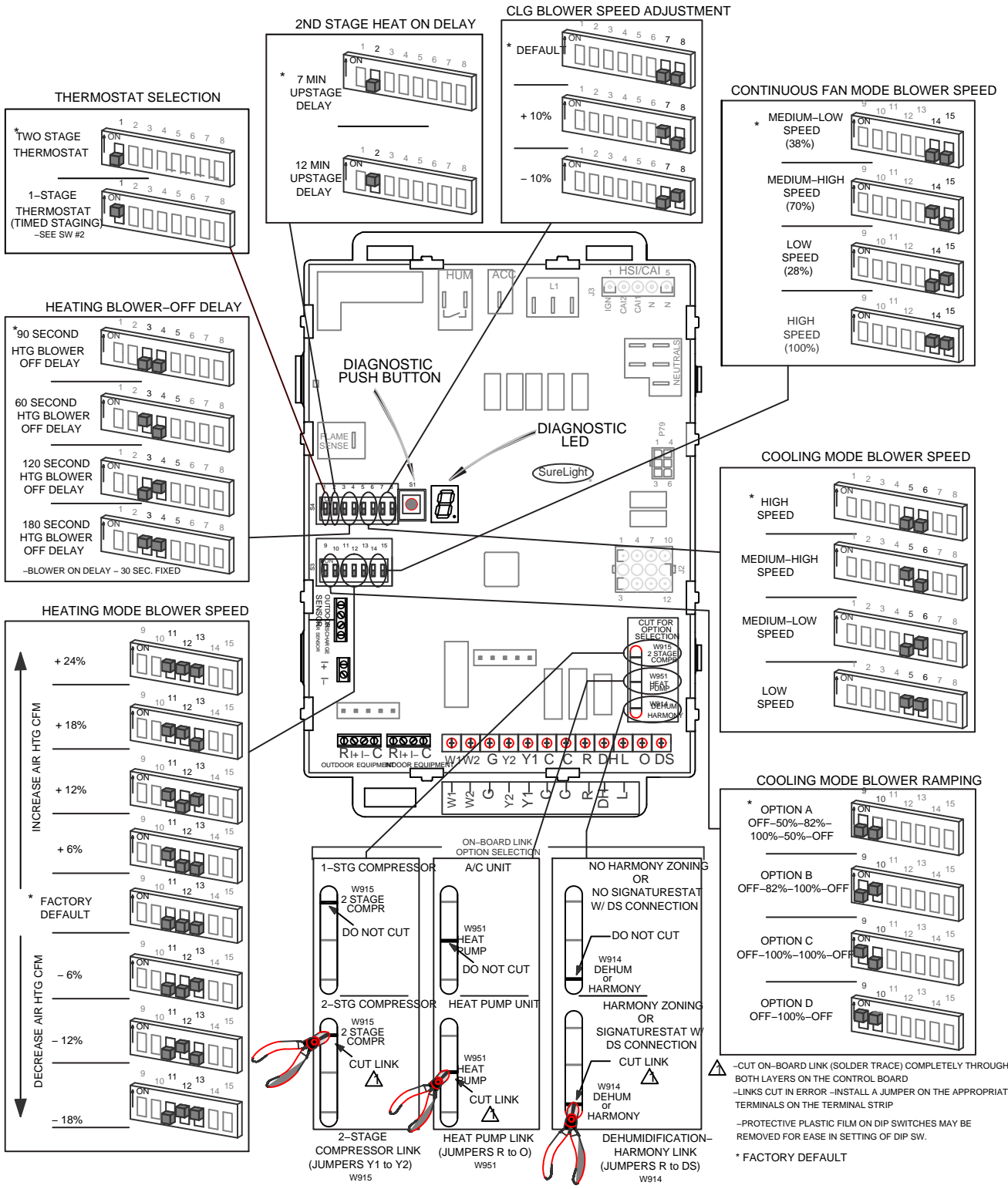

FIGURE 5

TABLE 4
Integrated Control Diagnostic Modes

Display	Action (when button released)
No change (idle)*	Remain in idle mode
Solid "E"	Enter diagnostic recall mode
Solid "D"	Discharge Air Installed
Solid "F"	Enter flame signal mode
Solid "P" (variable speed only)	Program unit capacity/size (Unit Code)

* No change implies the display will continue to show whatever is currently being displayed for normal operation (blinking decimal, active error code, heat state, etc..)

Diagnostic LED (Figure 4)

The seven-segment diagnostic LED displays operating status, target airflow, error codes and other information. The table beginning on Page 10 lists diagnostic LED codes.

Diagnostic Push Button (Figure 4)

The diagnostic push button is located adjacent to the seven-segment diagnostic LED. This button is used to enable the Error Code Recall "E" mode and the Flame Signal "F" mode. Press the button and hold it to cycle through a menu of options. Every five seconds a new menu item will be displayed. When the button is released, the displayed item will be selected. Once all items in the menu have been displayed, the menu resumes from the beginning until the button is released.

Error Code Recall Mode

Select "E" from the menu to access the most recent 10 error codes. Select "c" from the Error Code Recall menu to clear all error codes. Button must be pressed a second time while "c" is flashing to confirm command to delete codes. Press the button until a solid "≡" is displayed to exit the Error Code Recall mode.

Flame Signal Mode

Select "F" from the menu to access the flame signal mode. The integrated control will display the flame current on 7 segment LED in in micro amps (uA).

Flame signal mode is exited after any of the following:

- Power is reset
- Pressing and holding push button until 3 horizontal lines "≡" are displayed
- 10 minutes after entering the flame sense mode.

Program Unit Capacity/Size Mode

After the "P" is selected (by releasing the push button) the integrated control will start flashing the "P" on display for 90 seconds. If push button is pressed again and held during that time, the control will start to display characters corresponding to different variable speed furnace models for 3 seconds each. While the wanted character-model is displayed push button has to be released. Selected option will flash display for 10 seconds and during that time push button has to be pressed and held for 5 seconds. Once control accepts new setting it will store data in non-volatile memory and reset itself. If 10 seconds expires or push button is held less than 5 seconds, control will exit field test mode and go into idle without changing programming the unit size.

TABLE 5
Integrated Diagnostic Codes/Status of Equipment I.

Code	Diagnostic Codes/Status of Equipment	Action Required to Clear and Recover
.	Idle mode (Decimal blinks at 1 Hertz -- 0.5 second ON, 0.5 second OFF).	
A	Cubic feet per minute (cfm) setting for indoor blower (1 second ON, 0.5 second OFF) / cfm setting for current mode displayed.	
C	Cooling stage (1 second ON, 0.5 second OFF) / 1 or 2 displayed / Pause / cfm setting displayed / Pause / Repeat codes).	
d	Dehumidification mode (1 second ON) / 1 second OFF) / cfm setting displayed / Pause / Repeat Codes).	
h	Heat pump stage (1 second ON, 0.5 second OFF) / % of input rate displayed / Pause / cfm setting / Pause / Repeat codes.	
H	Gas Heat Stage (1 second ON, 0.5 second OFF) / 1 or 2 displayed / Pause / cfm setting displayed / Pause / Repeat codes. Blinking during ignition.	
dF	Defrost mode.	
U	Discharge Air Temperature	
E 105	Device communication problem - No other devices on RS BUS (Communication system).	Equipment is unable to communicate. Indicates numerous message errors. In most cases errors are related to electrical noise. Make sure high voltage power is separated from RSBus. Check for mis-wired and/or loose connections between the stat, indoor unit and outdoor unit. Check for a high voltage source of noise close to the system. Fault clears after communication is restored.
E 110	Low line voltage.	Line Voltage Low (Voltage lower than nameplate rating). Check power line voltage and correct. Alarm clears 5 seconds after fault recovered.
E 111	Line voltage polarity reversed.	Reverse line power voltage wiring. System resumes normal operation 5 seconds after fault recovered.
E 112	Ground not detected	System shuts down. Provide proper earth ground. System resumes normal operation 5 seconds after fault recovered.
E 113	High line voltage.	Line Voltage High (Voltage higher than nameplate rating). Provide power voltage within proper range. System resumes normal operation 5 seconds after fault recovered.
E 114	Line voltage frequency out-of-range.	No 60 Hertz Power. Check voltage and line power frequency. Correct voltage and frequency problems. System resumes normal operation 5 seconds after fault recovered.
E 115	Low 24V - Control will restart if the error recovers.	24-Volt Power Low (Range is 18 to 30 volts). Check and correct voltage. Check for additional power-robbing equipment connected to system. May require installation of larger VA transformer to be installed in furnace / air handler. Clears after fault recovered.
E 116	High 24V.	24 Volt Power High (Range is 18 to 30 volts). Check and correct voltage. Check for proper line voltage (120V, 240V, etc.) to equipment. Clears when control senses proper voltage.
E 117	Poor ground detected (Warning only)	Provide proper grounding for unit. Check for proper earth ground to the system. Warning only will clear 30 seconds after fault recovered.
E 120	Unresponsive device. Communication only.	Usually caused by delay in outdoor unit responding to indoor unit polling. Recycle power. Check all wiring connections. Cleared after unresponsive device responds to any inquiry.

TABLE 5 Continued

Code	Diagnostic Codes/Status of Equipment	Action Required to Clear and Recover
E 124	Active communicating thermostat signal missing for more than 3 minutes.	Equipment lost communication with the thermostat. Check four wiring connections, ohm wires and cycle power at the thermostat. Alert stops all services and waits for heartbeat message from thermostat (subnet controller). Cleared after valid thermostat (subnet controller) message is received.
E 125	Control failed self-check, internal error, failed hardware. Will restart if error recovers. Integrated control not communicating. Covers hardware errors (flame sense circuit faults, pin shorts, etc.).	Hardware problem on the control. Cycle power on control. Replace if problem prevents service and is persistent. Critical alert. Cleared 300 seconds after fault recovered.
E 126	Control internal communication problem.	Hardware problem on the control. Cycle power on control. Replace if problem prevents service and is persistent. Cleared 300 seconds after fault recovered.
E 131	Corrupted control parameters (Verify configuration of system). Communicating only.	Reconfigure the system. Replace control if heating or cooling is not available. Only applicable in the communicating mode, not in startup. Exit from Commissioning and Execute 'Set Factory Default mode'. Control will still operate on default parameter settings.
E 180	Outdoor air temperature sensor failure. Only shown if shorted or out-of-range.	Compare outdoor sensor resistance to temperature/resistance charts in unit installation instructions. Replace sensor pack if necessary. At beginning of (any) configuration, furnace or air handler control will sense outdoor air and discharge air temperature sensor(s). If detected (reading in range), appropriate feature will be set as 'installed' and that could be seen in 'About' screen. In normal operation after control recognizes sensors, alarm will be sent if valid temperature reading is lost. To get rid of setting and alarm, redo configuration and make sure that temperature sensor is marked as 'not installed' in Indoor Unit 'About' screen. When Indoor unit control is replaced, thermostat will 'tell' new control if temperature sensor is in system or not. Clears 30 seconds after fault recovered.
E 200	Hard lockout - Rollout circuit open or previously open.	Correct cause of rollout trip, or replace flame rollout switch. Test furnace operation. Cleared after fault recovered.
E 201	Indoor blower communication failure - Unable to communicate with blower motor.	Indoor blower communication failure (including power outage). Lost communication with indoor blower motor. Possible causes: motor not powered, loose wiring. Problem may be on control or motor side. Cleared after fault recovered.
E 202	Indoor blower motor mis-match - Indoor motor horsepower does not match unit capacity. See Page 59.	Incorrect appliance capacity code selected. Check for proper configuring under: Unit Size Codes for Furnace/Air Handler on configuration guide or in installation instructions. Cleared after the correct match is detected following a reset. (Remove thermostat from system while applying power and reprogramming.)
E 203	Appliance capacity / size is NOT programmed. Invalid unit codes refer to configuration flow chart. See Page 59.	No appliance capacity code selected. Check for proper configuring under: Unit Size Codes for Furnace on configuration guide or in installation instructions. Critical Alert. Cleared after valid unit code is read following a reset. (Remove thermostat from system while applying power and reprogramming.)
E 204	Gas valve mis-wired.	Check gas valve operation and wiring. Clears when repaired.
E 205	Gas valve control relay contact shorted.	Check wiring on control and gas valve. If wiring is correct, replace control.

TABLE 5 Continued

Code	Diagnostic Codes/Status of Equipment	Action Required to Clear and Recover
E 206	Gas valve second-stage relay failure	Furnace will operate on 1 st stage for remainder of the heating demand. Will clear after fault recovered. If unable to operate 2nd stage, replace control.
E 207	Hot surface ignitor sensed open - Refer to troubleshooting. See Page 60.	Measure resistance of hot surface ignitor. Replace if open or not within specified range found in IOM. Resumes normal operation after fault is cleared.
E 223	Low pressure switch failed open.	Check pressure (inches w.c.) of low pressure switch closing on heat call. Measure operating pressure (inches w.c.). Inspect vent and combustion air inducer for correct operation and restriction. Resumes normal operation after fault is cleared
E 224	Low pressure switch failed closed - Refer to troubleshooting. See Page 60.	Check operation of low pressure switch to see if it is stuck closed on heat call longer than 150 seconds. Measure operating pressure (inches w.c.). Inspect vent and combustion air inducer for correct operation and restriction. Resumes normal operation after fault is cleared.
E 225	High pressure switch failed open - Refer to troubleshooting. See Page 60.	Check pressure (inches w.c.) of high pressure switch closing on heat call. Measure operating pressure (inches w.c.). Inspect vent and combustion air inducer for correct operation and restriction. Resumes normal operation after fault is cleared.
E 226	High pressure switch failed closed - Refer to troubleshooting. See Page 60.	Check operation of high pressure switch closing on heat call. Measure operating pressure (inches w.c.). Inspect vent and combustion air inducer for correct operation and restriction. Resumes normal operation after fault is cleared.
E 227	Low pressure switch open during trial for ignition or run mode. Refer to troubleshooting. See Page 60.	Check pressure (inches w.c.) of low pressure switch closing on heat call. Measure operating pressure (inches w.c.). Inspect vent and combustion air inducer for correct operation and restriction. Resumes normal operation after fault is cleared.
E 228	Combustion air inducer calibration failure	Unable to perform pressure switch calibration. Check vent system and pressure switch wiring connections. Resumes normal operation after fault is cleared.
E 229	Ignition on High Fire - Information Only	Code is displayed if 1) low pressure switch fails to close, then furnace will switch to high speed inducer to close both low and high pressure switches, then furnace lights on high fire, or 2) if continuous fan is active, furnace lights on high fire for 60 seconds to improve heat exchanger warm up time.
E 240	Low flame current - Run mode - Refer to troubleshooting. See Page 60.	Check micro-amperes of flame sensor using control diagnostics or field-installed mode. Clean or replace sensor. Measure voltage of neutral to ground to ensure good unit ground. Alert clears after current heat call has been completed.
E 241	Flame sensed out of sequence - Flame still present.	Shut off gas. Check for gas valve leak. Replace, if necessary. Alert clears when fault is recovered.
E 250	Limit switch circuit open - Refer to troubleshooting. See Page 60	Check for proper firing rate on furnace. Ensure there is no blockage in heater. Check for proper air flow. If limit not closed within 3 minutes, unit will go into 1-hour soft lockout. Resumes normal operation after fault is cleared.
E 252	Discharge air temperature too high (gas heat only).	Check temperature rise, air flow and input rate. Cleared when heat call is finished.
E 270	Soft lockout - Exceeded maximum number of retries. No flame current sensed.	Check for proper gas flow. Ensure that ignitor is lighting burner. Check flame sensor current. Clears when heat call finishes successfully.

TABLE 5 Continued

Code	Diagnostic Codes/Status of Equipment	Action Required to Clear and Recover
E 271	Soft lockout - Exceeded maximum number of retries. Last retry failed due to the pressure switch opening.	Check pressure (inches w.c.) of low pressure switch closing on heat call. Measure operating pressure (inches w.c.). Inspect vent and combustion air inducer for correct operation and restriction. Clears when heat call finishes successfully.
E 272	Soft lockout - Exceeded maximum number of recycles. Last recycle due to the pressure switch opening.	Check operation of low pressure switch to see if it is stuck closed on heat call. Check pressure (inches w.c.) of high pressure switch closing on heat call. Measure operating pressure (inches w.c.). Inspect vent and combustion air inducer for correct operation and restriction. Clears when heat call finishes successfully.
E 273	Soft lockout - Exceeded maximum number of recycles. Last recycle due to flame failure.	Check micro-amperes of flame sensor using control diagnostics or field-installed mode. Clean or replace sensor. Measure voltage of neutral to ground to ensure good unit ground. Clears when heat call finishes successfully.
E 274	Soft lockout - Exceeded maximum number of recycles. Last recycle failed due to the limit circuit opening or limit remained open longer than 3 minutes.	Shut down system. 1-hour soft lockout. Check firing rate and air flow. Check for blockage. Clears when heat call finishes successfully.
E 275	Soft lockout - Flame sensed out of sequence. Flame signal is gone.	Shut off gas. Check for gas valve leak. 1-hour soft lockout. Clears when flame has been proven stable.
E 276	Watchguard calibration failure.	Unable to perform pressure switch calibration. Check vent system and pressure switch wiring connections. 1-hour soft lockout. Clears when calibration has finished successfully.
E 290	Ignitor circuit fault - Failed ignitor or triggering circuitry.	Measure resistance of hot surface ignitor. Replace if open or not within specifications. 1-hour soft lockout. Clears when flame has been proven stable.
E 291	Heat air flow restricted below the minimum.	Check for dirty filter and air flow restriction. Check blower performance. 1-hour soft lockout. Cleared when heat call finishes successfully.
E 292	Indoor blower motor unable to start due to obstructed wheel, seized bearings.	Indoor blower motor unable to start (seized bearing, stuck wheel, etc.). Replace motor or wheel if assembly does not operate or meet performance standards. 1-hour soft lockout. Clears after circulator successfully starts.
E 294	Combustion air inducer over current.	Check combustion blower bearings, wiring and amps. Replace if does not operate or does not meet performance standards. Clears after inducer current is sensed to be in-range after the ignition following the soft lockout or reset.
E 295	Indoor blower motor temperature is too high.	Indoor blower motor over temperature (motor tripped on internal protector). Check motor bearings and amps. Replace if necessary. Cleared after blower demand is satisfied.
E 310	Discharge error temperature sensor failure. Only shown if shorted or out of range.	Compare outdoor sensor resistance to temperature/resistance charts in installation instructions. Replace sensor if necessary. Cleared in Communicating mode: 30 seconds after fault recovered. In Non-Communicating mode: Cleared after the current heat call is completed.
E 311	Heat rate reduced to match indoor blower air flow.	Warning Only. Furnace blower in cutback mode due to restricted airflow. Reduce firing rate every 60 seconds to match available CFM. Check filter and duct system. To clear, replace filter if needed or repair/add duct. 2-stage controls will reduce firing rate to 1 st stage. Clears when heat call finishes successfully.

TABLE 5 Continued

Code	Diagnostic Codes/Status of Equipment	Action Required to Clear and Recover
E 312	Restricted air flow in cooling or continuous fan mode is lower than cfm setting.	Warning Only. Restricted airflow - Indoor blower is running at a reduced CFM (Cutback Mode - The variable speed motor has pre-set speed and torque limiters to protect the motor from damage caused by operating outside of design parameters (0 to 0.8" W.C.. total external static pressure). Check filter and duct system. To clear, replace filter if needed or repair/add duct. Cleared after the current service demand is satisfied.
E 313	Indoor or outdoor unit capacity mismatch. Communication only.	Incorrect indoor/outdoor capacity code selected. Check for proper configuring in installation instructions. Alarm is just a warning. The system will operate, but might not meet efficiency and capacity parameters. Alarm will clear when commissioning is exited. Cleared after commissioning is complete.
E 331	Global network connection - Communication link problem.	For Future Use.
E 334	Relay "Y1" stuck on interated control.	Replace integrated control.
E 347	No 24 Volt output on Y1 of "integrated control" with non communicating outdoor unit.	Operation stopped. Y1 relay / Stage 1 failed. (Pilot relay contacts did not close or the relay coil did not energize; no input back to IFC chip). Critical Alert. Cleared after reset and Y1 input sensed.
E 348	No 24 Volt output on Y2 of "integrated control" with non?communicating outdoor unit.	Y2 relay / Stage 2 failed. (Pilot relay contacts did not close or the relay coil did not energize; no input back to IFC chip). Critical Alert. Cleared after reset and Y1 input sensed.
E 349	No 24 Volts between R & O on "integrated control" with non communicating outdoor unit (Dual fuel module required for heat pump application).	Configuration link R to O needs to be restored. Replace link or hard-wire. Applicable in non communicating mode. Critical Alert.
E 370	Interlock switch sensed open for 2 minutes.	Control sees the loss of 24VAC for 2 minutes .Terminate all services and wait for interlock switch to close. The alarm will clear when 24VAC is continuously sensed on DS terminal for a minimum of 10 seconds or on a power reset.
E 400	LSOM - Compressor internal overload tripped.	Thermostat demand Y1 is present; but, compressor is not running. Check power to outdoor unit. Clears the error after current is sensed in both RUN and START sensors for at least 2 seconds, or after service is removed, or after power reset.
E 401	LSOM Compressor long run cycle or low system pressure.	Compressor ran more than 18 hours to satisfy a single thermostat demand. Critical Alert. Clears the error after 30 consecutive normal run cycles or power reset. Also monitors low pressure switch trips.
E 402	LSOM - Outdoor unit system pressure trip.	Discharge or suction pressure out-of-limits, or compressor overloaded. Clears the error after 4 consecutive normal compressor run cycles.
E 403	LSOM - Compressor short-cycling. .(Running less than 4 minutes). Outdoor unit pressure trip	Compressor runs less than 3 minutes to satisfy a thermostat demand. Clears the error after 4 consecutive normal run cycles or power reset.
E 404	LSOM - Compressor rotor locked. Compressor short-cycling. (Running less than 4 minutes).	Compressor rotor locked up due to run capacitor short, bearings are seized, excessive liquid refrigerant, etc. Clears the error after 4 consecutive normal run cycles or after power reset.
E 405	LSOM - Compressor open circuit.	Compressor circuit open (due to power disconnection, open fuse, etc.) Clears the error after 1 normal compressor run cycle.

TABLE 5 Continued

Code	Diagnostic Codes/Status of Equipment	Action Required to Clear and Recover
E 406	LSOM - Compressor open start circuit.	Required amount of current is not passing through Start current transformer. Clears the error after current is sensed in START sensor, or after power reset.
E 407	LSOM - Compressor open run circuit.	Required amount of current is not passing through Run current transformer. Clears the error after current is sensed in RUN sensor, or 1 normal compressor run cycle, or after power reset.
E 408	LSOM - Compressor contactor is welded.	Compressor runs continuously. Clears the error after 1 normal compressor run cycle or after power reset.
E 409	LSOM - Compressor low voltage.	Secondary voltage is below 18VAC. After 10 minutes, operation is discontinued. Clears the code after voltage is higher than 20 VAC for 2 seconds or after power reset.

DIP Switch Settings

NOTE - All *icomfort™* settings are set at the *icomfort Wi-Fi®* thermostat. See *icomfort™* installation instruction. In *icomfort™* communication system all DIP switch and clippable link settings are ignored. For conventional thermostats proceed with DIP switch and clippable link settings as outlined in the following.

Heating Operation DIP Switch Settings

Switch 1 -- Thermostat Selection -- This unit may be used with either a single-stage or two-stage thermostat. The thermostat selection is made using a DIP switch which must be properly positioned for the particular application. The DIP switch is factory-positioned for use with a two-stage thermostat. If a single-stage thermostat is to be used, the DIP switch must be repositioned.

- a - Select “OFF” for two-stage heating operation controlled by a two-stage heating thermostat (factory setting);
- b - Select “ON” for two-stage heating operation controlled by a single-stage heating thermostat. This setting provides a timed delay before second-stage heat is initiated.

Switch 2 -- Second Stage Delay (Used with Single-Stage Thermostat Only) -- This switch is used to determine the second stage on delay when a single-stage thermostat is being used. The switch is factory-set in the OFF position, which provides a 7-minute delay before second-stage heat is initiated. If the switch is toggled to the ON position, it will provide a 12-minute delay before second-stage heat is initiated. This switch is only activated when the thermostat selector jumper is positioned for SINGLE-stage thermostat use.

Switches 3 and 4 -- Blower-Off Delay -- The blower-off delay of 30 seconds is not adjustable. The blower-off delay (time that the blower operates after the heating demand has been satisfied) can be adjusted by moving switches 3 and 4 on the integrated control. The unit is shipped from the factory with a blower-off delay of 90 seconds. The blower

off delay affects comfort and is adjustable to satisfy individual applications. Adjust the blower off delay to achieve a supply air temperature between 90° and 110°F at the exact moment that the blower is de-energized. Longer off delay settings provide lower supply air temperatures; shorter settings provide higher supply air temperatures. Table 6 provides the blower off timings that will result from different switch settings.

**TABLE 6
Blower Off Delay Switch Settings**

Blower Off Delay (Seconds)	Switch 3	Switch 4
60	On	Off
90 (Factory)	Off	Off
120	Off	On
180	On	On

Indoor Blower Operation DIP Switch Settings

Switches 5 and 6 -- Cooling Mode Blower Speed -- The unit is shipped from the factory with the dip switches positioned for high speed (4) indoor blower motor operation during the cooling mode. Table 7 provides the cooling mode blower speeds that will result from different switch settings. Switches 5 and 6 set the blower cfm for second-stage cool. The integrated control automatically ramps down to 70% of the second-stage cfm for first-stage cfm. Refer to tables for corresponding cfm values.

**TABLE 7
Cooling Mode Blower Speeds**

Speed	Switch 5	Switch 6
Low	On	On
Medium Low	Off	On
Medium High	On	Off
High (Factory)	Off	Off

Switches 7 and 8 -- Cooling Blower Speed Adjustment

-- The unit is shipped from the factory with the dip switches positioned for NORMAL (no) adjustment. The dip switches may be positioned to adjust the blower speed by +10% or

-10% to better suit the application. Table 8 below provides blower speed adjustments that will result from different switch settings. Refer to tables for corresponding cfm values.

TABLE 8
Cooling Blower Speed Adjustment

Adjustment	Switch 7	Switch 8
+10% (approx.)	On	Off
Factory Default	Off	Off
-10% (approx.)	Off	On

Switches 9 and 10 -- Cooling Mode Blower Speed Ramping -- Blower speed ramping may be used to enhance dehumidification performance. The switches are factory set at option A which has the greatest effect on dehumidification performance. Table 9 provides the cooling mode blower speed ramping options that will result from different switch settings. The cooling mode blower speed ramping options are detailed below.

NOTE - The off portion of the selected ramp profile also applies during heat pump operation in dual fuel applications.

TABLE 9
Cooling Mode Blower Speed Ramping

Ramping Option	Switch 9	Switch 10
A (Factory)	Off	Off
B	Off	On
C	On	Off
D	On	On

Ramping Option A (Factory Selection)

- Motor runs at 50% for 30 seconds.
- Motor then runs at 82% for approximately 7-1/2 minutes.
- If demand has not been satisfied after 7-1/2 minutes, motor runs at 100% until demand is satisfied.
- Once demand is met, motor runs at 50% for 30 seconds then ramps down to stop.

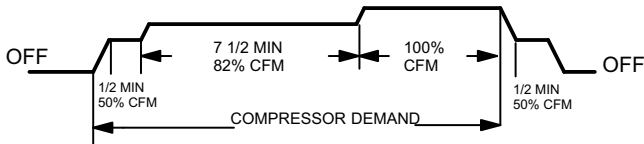

Ramping Option B

- Motor runs at 82% for approximately 7-1/2 minutes. If demand has not been satisfied after 7-1/2 minutes, motor runs at 100% until demand is satisfied.
- Once demand is met, motor ramps down to stop.

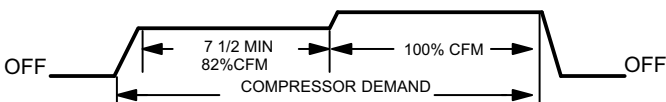

Ramping Option C

- Motor runs at 100% until demand is satisfied.
- Once demand is met, motor runs at 100% for 45 seconds then ramps down to stop.

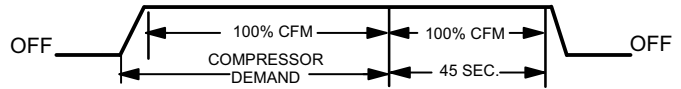

Ramping Option D

- Motor runs at 100% until demand is satisfied.
- Once demand is met, motor ramps down to stop.

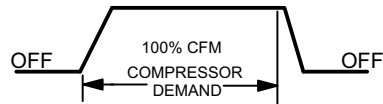

Switches 11, 12 and 13 -- Heating Mode Blower Speed

The switches are factory set to the OFF position which provides factory default heat speed. Refer to table 10 for switches 11, 12 and 13 that provided the corresponding increases or decrease to both high and low heat demand.

TABLE 10
Heating Mode Blower Speeds

Heat Speed	Switch 11	Switch 12	Switch 13
Increase 24%	On	On	On
Increase 18%	On	On	Off
Increase 12%	On	Off	On
Increase 6%	On	Off	Off
Factory Default	Off	Off	Off
Decrease 6%	Off	Off	On
Decrease 12%	Off	On	Off
Decrease 18%	Off	On	On

Switches 14 and 15 -- Continuous Blower Speed

Table 11 provides continuous blower speed adjustments that will result from different switch settings.

TABLE 11
Continuous Blower Speed

Continuous Blower Speed	Switch 14	Switch 15
28% of High Cool Speed	Off	On
38% of High Cool Speed (Factory)	Off	Off
70% of High Cool Speed	On	Off
100% of High Cool Speed	On	On

BLOWER DATA

SL280UH070V36A BLOWER PERFORMANCE (less filter)

BOTTOM RETURN AIR

0 through 0.8 in. w.g. (Heating) and 0 through 1.0 in. w.g. (Cooling) External Static Pressure Range

HEATING

¹ Heating Speed DIP Switch Settings	First Stage Heating Speed - cfm	Second Stage Heating Speed - cfm
+24%	1045	1145
+18%	985	1080
+12%	940	1035
+6%	880	960
Factory Default	850	925
-6%	785	875
-12%	745	815
-18%	680	745

COOLING

¹ Cooling Speed DIP Switch Settings	First Stage Cooling Speed - cfm				Second Stage Cooling Speed - cfm			
	Low	Medium-Low	Medium-High	² High	Low	Medium-Low	Medium-High	² High
+	781	819	872	981	1045	1139	1219	1372
Factory Default	695	734	797	883	943	1005	1114	1260
-	645	674	720	815	847	922	991	1144

¹ Cooling and heating speeds are based on a combination of DIP switch settings on the furnace control. Refer to Installation Instructions for specific DIP Switch Settings.

² Factory default setting.

NOTES - The effect of static pressure is included in air volumes shown.

First stage HEAT is approximately 91% of the same second stage HEAT.

First stage COOL (two-stage air conditioning units only) is approximately 70% of the same second stage COOL speed position.

Continuous Fan Only speed is selectable at 28%, 38%, 70% and 100% of the selected second stage cooling speed - minimum 250 cfm.

Lennox Harmony III™ Zone Control Applications - Minimum blower speed is 250 cfm.

SL280UH070V36A BLOWER MOTOR WATTS (COOLING)

¹ Cooling Speed DIP Switch Settings	Motor Watts @ Various External Static Pressures - in. wg.																				
	First Stage										Second Stage										
	0	0.1	0.2	0.3	0.4	0.5	0.6	0.7	0.8	0	0.1	0.2	0.3	0.4	0.5	0.6	0.7	0.8	0.9	1.0	
+ Setting																					
Cooling Speed	Low	32	55	70	94	111	131	152	174	194	100	123	144	170	196	232	260	266	299	306	343
	Med-low	43	66	87	103	128	147	167	190	217	134	153	185	211	241	266	291	316	342	367	384
	Med-High	53	74	97	120	143	165	184	209	228	181	198	234	261	289	316	342	367	390	411	436
	High	77	101	123	148	175	194	218	242	266	259	282	318	339	375	402	430	457	489	507	536
Factory Default																					
Cooling Speed	Low	26	44	61	78	94	114	138	152	163	66	86	112	139	160	174	199	223	247	270	296
	Med-low	27	49	66	83	106	126	147	169	182	87	107	134	158	182	206	232	258	274	302	319
	Med-High	37	57	78	104	122	138	167	186	203	127	150	173	207	237	267	288	313	340	360	390
	High	60	85	101	123	148	167	193	211	236	197	218	249	277	306	333	358	388	412	434	454
- Setting																					
Cooling Speed	Low	19	34	54	69	86	105	119	144	149	45	66	91	105	138	150	176	189	213	237	266
	Med-low	23	41	56	75	90	112	132	144	159	61	86	103	132	150	172	193	217	233	262	291
	Med-High	24	45	63	82	102	121	139	161	183	84	107	139	153	178	204	234	259	280	304	325
	High	38	59	81	104	123	145	170	188	208	136	158	190	213	236	268	290	318	339	367	390

BLOWER DATA

SL280UH070V36A BLOWER PERFORMANCE (less filter)

SINGLE SIDE RETURN AIR

0 through 0.8 in. w.g. (Heating) and 0 through 1.0 in. w.g. (Cooling) External Static Pressure Range

HEATING

¹ Heating Speed DIP Switch Settings	First Stage Heating Speed - cfm				Second Stage Heating Speed - cfm			
	+24%	1050				1165		
+18%	1000				1110			
+12%	940				1040			
+6%	895				975			
Factory Default	820				935			
-6%	775				855			
-12%	735				805			
-18%	685				750			

COOLING

¹ Cooling Speed DIP Switch Settings	First Stage Cooling Speed - cfm				Second Stage Cooling Speed - cfm			
	Low	Medium-Low	Medium-High	² High	Low	Medium-Low	Medium-High	² High
+	764	802	886	977	1035	1122	1248	1360
Factory Default	704	725	793	899	949	1029	1135	1257
-	642	680	717	812	874	933	1021	1133

¹ Cooling and heating speeds are based on a combination of DIP switch settings on the furnace control. Refer to Installation Instructions for specific DIP Switch Settings.

² Factory default setting.

NOTES - The effect of static pressure is included in air volumes shown.

First stage HEAT is approximately 91% of the same second stage HEAT.

First stage COOL (two-stage air conditioning units only) is approximately 70% of the same second stage COOL speed position.

Continuous Fan Only speed is selectable at 28%, 38%, 70% and 100% of the selected second stage cooling speed - minimum 250 cfm.

Lennox Harmony III™ Zone Control Applications - Minimum blower speed is 250 cfm.

SL28UH070V36A BLOWER MOTOR WATTS (COOLING)

¹ Cooling Speed DIP Switch Settings	Motor Watts @ Various External Static Pressures - in. wg.																				
	First Stage										Second Stage										
	0	0.1	0.2	0.3	0.4	0.5	0.6	0.7	0.8	0	0.1	0.2	0.3	0.4	0.5	0.6	0.7	0.8	0.9	1.0	
+ Setting																					
Cooling Speed	Low	36	54	73	95	113	130	147	170	186	90	112	138	159	190	213	236	263	284	305	329
	Med-low	40	61	80	99	124	139	164	182	201	125	136	166	193	218	243	270	271	292	320	340
	Med-High	52	74	98	116	140	162	182	207	226	163	181	217	246	274	311	331	358	382	410	430
	High	77	100	123	144	165	187	213	234	259	236	259	290	327	354	381	413	448	467	496	519
Factory Default																					
Cooling Speed	Low	22	42	63	74	98	119	135	158	174	68	90	107	134	157	175	202	222	239	260	286
	Med-low	30	49	68	83	111	126	139	160	184	86	109	135	153	178	204	232	258	273	292	321
	Med-High	32	53	74	92	116	136	154	177	199	115	137	165	197	221	247	272	300	326	348	370
	High	55	74	97	120	143	165	181	203	224	172	192	227	257	281	310	342	372	391	422	435
- Setting																					
Cooling Speed	Low	17	31	48	69	82	97	111	131	146	48	67	89	110	129	152	172	194	215	231	251
	Med-low	22	43	57	74	84	109	130	140	163	62	84	103	124	151	173	196	212	233	258	277
	Med-High	28	49	64	78	104	117	136	156	176	87	112	132	151	180	203	228	251	273	292	317
	High	36	56	72	99	118	139	164	177	194	114	137	162	198	221	247	279	302	328	352	374

BLOWER DATA

SL280UH090V36B BLOWER PERFORMANCE (less filter)

BOTTOM RETURN AIR

0 through 0.8 in. w.g. (Heating) and 0 through 1.0 in. w.g. (Cooling) External Static Pressure Range

HEATING

¹ Heating Speed DIP Switch Settings	First Stage Heating Speed - cfm		Second Stage Heating Speed - cfm	
	+24%	1300		1420
+18%	1250		1335	
+12%	1185		1285	
+6%	1145		1240	
Factory Default	1070		1170	
-6%	1015		1100	
-12%	970		1035	
-18%	880		980	

COOLING

¹ Cooling Speed DIP Switch Settings	First Stage Cooling Speed - cfm				Second Stage Cooling Speed - cfm			
	Low	Medium-Low	Medium-High	² High	Low	Medium-Low	Medium-High	² High
+	616	755	846	980	1018	1197	1291	1399
Factory Default	571	698	767	886	909	1083	1197	1284
-	489	627	681	812	834	968	1081	1179

¹ Cooling and heating speeds are based on a combination of DIP switch settings on the furnace control. Refer to Installation Instructions for specific DIP Switch Settings.

² Factory default setting.

NOTES - The effect of static pressure is included in air volumes shown.

First stage HEAT is approximately 91% of the same second stage HEAT.

First stage COOL (two-stage air conditioning units only) is approximately 70% of the same second stage COOL speed position.

Continuous Fan Only speed is selectable at 28%, 38%, 70% and 100% of the selected second stage cooling speed - minimum 250 cfm.

Lennox Harmony III™ Zone Control Applications - Minimum blower speed is 250 cfm.

SL280UH090V36B BLOWER MOTOR WATTS (COOLING)

¹ Cooling Speed DIP Switch Settings	Motor Watts @ Various External Static Pressures - in. wg.																				
	First Stage										Second Stage										
	0	0.1	0.2	0.3	0.4	0.5	0.6	0.7	0.8	0	0.1	0.2	0.3	0.4	0.5	0.6	0.7	0.8	0.9	1.0	
+ Setting																					
Cooling Speed	Low	13	29	43	62	73	86	105	122	137	63	85	105	134	159	186	207	230	252	275	292
	Med-low	27	46	64	84	102	119	137	159	177	112	136	157	193	224	247	277	300	321	350	372
	Med-High	43	59	80	104	119	143	159	178	191	145	163	199	233	264	289	316	345	374	397	417
	High	57	78	103	125	148	181	202	219	245	190	219	254	273	310	351	377	408	442	467	489
Factory Default																					
Cooling Speed	Low	12	25	42	55	65	86	93	115	123	51	70	97	113	139	155	176	199	221	242	261
	Med-low	22	38	52	70	89	108	121	135	150	77	99	129	152	184	206	231	264	283	307	333
	Med-High	27	46	64	85	103	123	141	157	179	112	136	157	193	224	247	277	300	321	350	372
	High	51	68	90	110	136	150	172	198	211	145	164	197	232	257	290	320	351	362	396	411
- Setting																					
Cooling Speed	Low	9	21	35	45	60	74	89	100	119	41	59	80	96	116	136	159	176	195	204	230
	Med-low	16	29	46	64	78	93	106	121	138	58	80	104	124	150	175	192	221	238	260	284
	Med-High	22	40	54	68	90	108	125	141	153	73	94	125	152	177	203	228	258	279	304	326
	High	36	53	72	91	112	131	150	169	185	99	125	154	182	207	234	266	296	320	344	369

BLOWER DATA

SL280UH090V36B BLOWER PERFORMANCE (less filter)

SINGLE SIDE RETURN AIR

0 through 0.8 in. w.g. (Heating) and 0 through 1.0 in. w.g. (Cooling) External Static Pressure Range

HEATING

¹ Heating Speed DIP Switch Settings	First Stage Heating Speed - cfm				Second Stage Heating Speed - cfm			
	Low	Medium-Low	Medium-High	² High	Low	Medium-Low	Medium-High	² High
+24%	1305				1425			
+18%	1250				1350			
+12%	1195				1290			
+6%	1135				1230			
Factory Default	1070				1165			
-6%	995				1100			
-12%	935				1030			
-18%	870				960			

COOLING

¹ Cooling Speed DIP Switch Settings	First Stage Cooling Speed - cfm				Second Stage Cooling Speed - cfm			
	Low	Medium-Low	Medium-High	² High	Low	Medium-Low	Medium-High	² High
+	611	731	830	971	995	1160	1274	1376
Factory Default	575	674	748	870	889	1075	1160	1270
-	519	604	691	786	808	952	1056	1147

¹ Cooling and heating speeds are based on a combination of DIP switch settings on the furnace control. Refer to Installation Instructions for specific DIP Switch Settings.

² Factory default setting.

NOTES - The effect of static pressure is included in air volumes shown.

First stage HEAT is approximately 91% of the same second stage HEAT.

First stage COOL (two-stage air conditioning units only) is approximately 70% of the same second stage COOL speed position.

Continuous Fan Only speed is selectable at 28%, 38%, 70% and 100% of the selected second stage cooling speed - minimum 250 cfm.

Lennox Harmony III™ Zone Control Applications - Minimum blower speed is 250 cfm.

SL280UH090V36B BLOWER MOTOR WATTS (COOLING)

¹ Cooling Speed DIP Switch Settings	Motor Watts @ Various External Static Pressures - in. wg.																				
	First Stage										Second Stage										
	0	0.1	0.2	0.3	0.4	0.5	0.6	0.7	0.8	0	0.1	0.2	0.3	0.4	0.5	0.6	0.7	0.8	0.9	1.0	
+ Setting																					
Cooling Speed	Low	10	27	41	57	72	88	105	123	135	55	82	99	123	148	173	199	220	244	266	290
	Med-low	23	44	59	80	99	119	138	158	177	103	129	151	184	214	235	264	290	316	342	368
	Med-High	37	56	75	95	114	135	153	174	189	147	167	205	230	264	285	317	347	365	394	423
	High	54	81	95	120	144	170	191	217	234	189	219	249	273	312	339	379	404	431	459	485
Factory Default																					
Cooling Speed	Low	8	24	34	50	70	83	96	110	124	39	63	85	105	131	147	174	193	214	243	264
	Med-low	16	36	50	68	86	106	121	144	159	73	92	123	148	173	203	221	249	266	297	317
	Med-High	23	43	61	81	106	123	144	160	182	103	129	151	184	214	235	264	290	316	342	368
	High	43	62	88	107	123	145	169	189	209	149	170	199	234	259	291	311	334	367	389	412
- Setting																					
Cooling Speed	Low	4	18	29	45	59	74	86	98	113	31	52	67	92	113	129	156	175	197	209	232
	Med-low	11	29	44	58	79	93	111	129	141	50	76	97	116	141	159	185	206	235	250	282
	Med-High	15	36	52	67	86	108	126	144	161	68	89	121	139	167	192	219	243	269	292	310
	High	32	53	70	94	109	129	153	174	189	95	118	144	178	198	226	256	278	302	328	352

BLOWER DATA

SL280UH090V48B BLOWER PERFORMANCE (less filter)

BOTTOM RETURN AIR

0 through 0.8 in. w.g. (Heating) and 0 through 1.0 in. w.g. (Cooling) External Static Pressure Range

HEATING

¹ Heating Speed DIP Switch Settings	First Stage Heating Speed - cfm	Second Stage Heating Speed - cfm
+24%	1280	1410
+18%	1220	1340
+12%	1155	1270
+6%	1095	1205
Factory Default	1035	1135
-6%	970	1070
-12%	910	1000
-18%	845	930

COOLING

¹ Cooling Speed DIP Switch Settings	First Stage Cooling Speed - cfm				Second Stage Cooling Speed - cfm			
	Low	Medium-Low	Medium-High	² High	Low	Medium-Low	Medium-High	² High
+	670	890	1040	1210	1030	1335	1550	1755
Factory Default	605	815	965	1090	940	1205	1405	1,600
-	525	690	850	985	795	1060	1260	1435

¹ Cooling and heating speeds are based on a combination of DIP switch settings on the furnace control. Refer to Installation Instructions for specific DIP Switch Settings.

² Factory default setting.

NOTES - The effect of static pressure is included in air volumes shown.

First stage HEAT is approximately 91% of the same second stage HEAT.

First stage COOL (two-stage air conditioning units only) is approximately 70% of the same second stage COOL speed position.

Continuous Fan Only speed is selectable at 28%, 38%, 70% and 100% of the selected second stage cooling speed - minimum 380 cfm.

Lennox Harmony III™ Zone Control Applications - Minimum blower speed is 380 cfm.

SL280UH090V48B BLOWER MOTOR WATTS (COOLING)

¹ Cooling Speed DIP Switch Settings	Motor Watts @ Various External Static Pressures - in. wg.																				
	First Stage										Second Stage										
	0	0.1	0.2	0.3	0.4	0.5	0.6	0.7	0.8	0	0.1	0.2	0.3	0.4	0.5	0.6	0.7	0.8	0.9	1.0	
+ Setting																					
Cooling Speed	Low	40	56	75	86	105	128	141	157	173	93	125	144	161	182	209	237	258	286	307	338
	Med-low	64	86	105	122	146	169	187	207	227	167	196	240	262	299	328	367	398	433	467	492
	Med-High	93	119	141	163	189	213	237	261	286	259	287	321	374	410	451	481	518	555	581	611
	High	128	156	188	219	248	281	308	338	366	372	407	465	493	558	604	661	706	726	764	817
Factory Default																					
Cooling Speed	Low	35	51	64	79	92	107	122	138	159	81	105	122	139	159	186	200	221	247	263	286
	Med-low	50	65	85	114	130	148	173	179	200	112	142	173	206	234	271	300	323	356	395	419
	Med-High	75	98	117	136	159	177	187	207	244	189	221	254	289	335	362	400	431	458	504	526
	High	98	122	149	180	194	230	252	278	300	288	321	372	398	433	470	507	554	598	623	653
- Setting																					
Cooling Speed	Low	32	44	57	71	82	95	107	121	132	74	94	112	130	147	174	189	206	226	245	264
	Med-low	43	60	76	91	109	127	143	159	176	86	119	134	161	185	212	236	257	290	320	342
	Med-High	55	70	94	116	132	157	171	190	206	138	170	194	226	269	295	325	357	384	414	442
	High	80	100	123	147	166	187	210	231	253	204	235	269	312	342	376	425	450	482	516	546

BLOWER DATA

SL280UH090V48B BLOWER PERFORMANCE (less filter)

SINGLE SIDE RETURN AIR

0 through 0.8 in. w.g. (Heating) and 0 through 1.0 in. w.g. (Cooling) External Static Pressure Range

HEATING

¹ Heating Speed DIP Switch Settings	First Stage Heating Speed - cfm				Second Stage Heating Speed - cfm			
	+24%	1280				1410		
+18%	1220				1340			
+12%	1155				1270			
+6%	1095				1205			
Factory Default	1035				1135			
-6%	970				1070			
-12%	910				1000			
-18%	845				930			

COOLING

¹ Cooling Speed DIP Switch Settings	First Stage Cooling Speed - cfm				Second Stage Cooling Speed - cfm			
	Low	Medium-Low	Medium-High	² High	Low	Medium-Low	Medium-High	² High
+	640	900	1015	1175	1005	1295	1500	1670
Factory Default	570	780	930	1040	895	1160	1345	1500
-	530	700	810	955	795	1050	1210	1405

¹ Cooling and heating speeds are based on a combination of DIP switch settings on the furnace control. Refer to Installation Instructions for specific DIP Switch Settings.

² Factory default setting.

NOTES - The effect of static pressure is included in air volumes shown.

First stage HEAT is approximately 91% of the same second stage HEAT.

First stage COOL (two-stage air conditioning units only) is approximately 70% of the same second stage COOL speed position.

Continuous Fan Only speed is selectable at 28%, 38%, 70% and 100% of the selected second stage cooling speed - minimum 380 cfm.

Lennox Harmony III™ Zone Control Applications - Minimum blower speed is 380 cfm.

SL280UH090V48B BLOWER MOTOR WATTS (COOLING)

¹ Cooling Speed DIP Switch Settings	Motor Watts @ Various External Static Pressures - in. wg.																				
	First Stage										Second Stage										
	0	0.1	0.2	0.3	0.4	0.5	0.6	0.7	0.8	0	0.1	0.2	0.3	0.4	0.5	0.6	0.7	0.8	0.9	1.0	
+ Setting																					
Cooling Speed	Low	34	54	68	85	102	120	142	159	177	79	107	133	148	172	201	226	253	274	301	327
	Med-low	64	85	105	124	145	166	186	206	227	151	179	214	247	276	312	339	370	399	433	464
	Med-High	85	112	135	157	184	208	233	258	284	230	261	305	348	379	421	453	490	523	565	602
	High	110	139	172	201	234	270	294	326	352	478	369	414	462	506	547	597	643	691	735	781
Factory Default																					
Cooling Speed	Low	30	46	59	77	87	106	118	143	152	70	93	115	134	153	172	195	219	242	260	286
	Med-low	36	56	76	95	120	136	162	175	196	100	132	163	192	214	244	276	307	338	368	402
	Med-High	64	88	106	130	149	173	198	222	238	166	192	231	266	303	342	370	410	444	462	493
	High	87	118	141	161	194	223	248	275	302	245	273	333	365	396	432	460	503	546	579	635
- Setting																					
Cooling Speed	Low	28	43	53	70	83	97	110	120	135	53	72	88	112	133	150	175	191	205	230	245
	Med-low	37	56	72	86	106	124	141	158	176	84	111	134	154	185	215	235	260	284	311	336
	Med-High	51	69	90	109	129	152	168	187	205	119	152	182	210	244	276	307	338	370	401	432
	High	71	94	119	138	158	181	207	233	250	180	211	248	284	316	355	385	419	450	487	521

BLOWER DATA

SL280UH090V48B BLOWER PERFORMANCE (less filter)

SIDE RETURN AIR WITH OPTIONAL RETURN AIR BASE

0 through 0.8 in. w.g. (Heating) and 0 through 1.0 in. w.g. (Cooling) External Static Pressure Range

HEATING

¹ Heating Speed DIP Switch Settings	First Stage Heating Speed - cfm	Second Stage Heating Speed - cfm
+24%	1295	1425
+18%	1235	1355
+12%	1170	1290
+6%	1110	1220
Factory Default	1045	1150
-6%	980	1080
-12%	920	1010
-18%	855	945

COOLING

¹ Cooling Speed DIP Switch Settings	First Stage Cooling Speed - cfm				Second Stage Cooling Speed - cfm			
	Low	Medium-Low	Medium-High	² High	Low	Medium-Low	Medium-High	² High
+	660	905	1030	1175	985	1290	1495	1675
Factory Default	600	760	930	1045	905	1125	1345	1525
-	535	700	850	970	815	1040	1225	1385

¹ Cooling and heating speeds are based on a combination of DIP switch settings on the furnace control. Refer to Installation Instructions for specific DIP Switch Settings.

² Factory default setting.

NOTES - The effect of static pressure is included in air volumes shown.

First stage HEAT is approximately 91% of the same second stage HEAT.

First stage COOL (two-stage air conditioning units only) is approximately 70% of the same second stage COOL speed position.

Continuous Fan Only speed is selectable at 28%, 38%, 70% and 100% of the selected second stage cooling speed - minimum 380 cfm.

Lennox Harmony III™ Zone Control Applications - Minimum blower speed is 380 cfm.

SL280UH090V48B BLOWER MOTOR WATTS (COOLING)

¹ Cooling Speed DIP Switch Settings	Motor Watts @ Various External Static Pressures - in. wg.																				
	First Stage										Second Stage										
	0	0.1	0.2	0.3	0.4	0.5	0.6	0.7	0.8	0	0.1	0.2	0.3	0.4	0.5	0.6	0.7	0.8	0.9	1.0	
+ Setting																					
Cooling Speed	Low	34	54	65	84	101	122	138	156	169	75	104	128	146	170	193	224	244	266	300	326
	Med-low	57	74	97	120	137	158	177	197	216	124	160	189	216	254	287	319	351	385	416	449
	Med-High	76	102	125	147	174	200	223	248	272	208	238	279	319	350	391	422	457	489	529	564
	High	106	134	165	193	224	259	283	313	340	302	346	386	426	470	510	554	596	640	680	722
Factory Default																					
Cooling Speed	Low	31	47	59	74	89	105	123	139	150	64	88	107	131	150	173	196	217	241	263	285
	Med-low	43	61	82	101	118	144	158	177	194	94	123	150	183	213	243	279	300	331	353	393
	Med-High	62	85	104	130	151	173	196	216	239	150	180	219	250	294	333	368	399	428	463	497
	High	81	113	131	151	187	211	238	264	291	235	263	312	349	387	426	455	489	522	568	608
- Setting																					
Cooling Speed	Low	29	40	53	69	83	93	104	122	129	50	69	85	107	127	149	169	187	201	222	237
	Med-low	32	50	66	84	101	116	136	153	172	78	105	126	146	174	199	223	247	272	295	319
	Med-High	46	65	86	109	127	146	167	187	207	105	135	166	195	227	262	289	319	348	380	411
	High	69	92	112	134	156	175	200	221	245	161	195	230	264	298	334	367	401	434	469	503

BLOWER DATA

SL280UH090V60C BLOWER PERFORMANCE (less filter)

BOTTOM RETURN AIR, RETURN AIR FROM BOTH SIDES OR RETURN AIR FROM BOTTOM AND ONE SIDE

0 through 0.8 in. w.g. (Heating) and 0 through 1.0 in. w.g. (Cooling) External Static Pressure Range

HEATING

¹ Heating Speed DIP Switch Settings	First Stage Heating Speed - cfm				Second Stage Heating Speed - cfm			
	+24%	1420				1565		
+18%	1355				1490			
+12%	1285				1415			
+6%	1215				1335			
Factory Default	1145				1260			
-6%	1080				1185			
-12%	1010				1110			
-18%	940				1035			

COOLING

¹ Cooling Speed DIP Switch Settings	First Stage Cooling Speed - cfm				Second Stage Cooling Speed - cfm			
	Low	Medium-Low	Medium-High	² High	Low	Medium-Low	Medium-High	² High
+	1110	1205	1420	1680	1575	1740	2000	2305
Factory Default	1005	1100	1280	1545	1440	1595	1820	2125
-	890	1015	1125	1380	1295	1450	1610	1930

¹ Cooling and heating speeds are based on a combination of DIP switch settings on the furnace control. Refer to Installation Instructions for specific DIP Switch Settings.

² Factory default setting.

NOTES - The effect of static pressure is included in air volumes shown.

First stage HEAT is approximately 91% of the same second stage HEAT.

First stage COOL (two-stage air conditioning units only) is approximately 70% of the same second stage COOL speed position.

Continuous Fan Only speed is selectable at 28%, 38%, 70% and 100% of the selected second stage cooling speed - minimum 450 cfm.

Lennox Harmony III™ Zone Control Applications - Minimum blower speed is 450 cfm.

SL280UH090V60C BLOWER MOTOR WATTS (COOLING)

¹ Cooling Speed DIP Switch Settings	Motor Watts @ Various External Static Pressures - in. wg.																				
	First Stage										Second Stage										
	0	0.1	0.2	0.3	0.4	0.5	0.6	0.7	0.8	0	0.1	0.2	0.3	0.4	0.5	0.6	0.7	0.8	0.9	1.0	
+ Setting																					
Cooling Speed	Low	89	113	136	159	182	204	228	251	275	218	245	291	327	372	398	436	474	505	532	579
	Med-low	104	133	163	184	214	245	266	304	328	298	333	382	412	450	488	541	576	612	648	681
	Med-High	162	191	227	262	294	333	354	391	422	440	476	527	576	636	686	741	777	820	857	892
	High	279	316	355	394	432	473	509	547	584	772	808	877	946	1000	1056	1089	1146	1190	1255	1266
Factory Default																					
Cooling Speed	Low	70	92	108	134	159	174	196	215	242	160	195	228	265	291	340	364	397	442	469	500
	Med-low	89	115	135	156	185	207	227	250	281	241	267	305	347	384	413	445	477	519	542	573
	Med-High	122	149	183	206	234	269	297	324	350	330	370	414	452	500	542	593	634	675	702	747
	High	214	241	277	318	350	388	423	449	469	553	591	655	713	781	819	868	922	967	1026	1066
- Setting																					
Cooling Speed	Low	54	70	91	110	129	154	166	185	200	107	151	177	206	245	272	298	332	398	423	449
	Med-low	73	94	112	135	151	175	189	214	235	173	201	244	272	304	337	368	393	437	465	498
	Med-High	93	120	141	160	191	221	244	261	288	246	271	310	353	395	433	466	492	528	557	593
	High	149	185	217	251	284	314	352	386	422	410	456	505	543	595	635	692	729	777	829	867

BLOWER DATA

SL280UH090V60C BLOWER PERFORMANCE (less filter)

SINGLE SIDE RETURN AIR

0 through 0.8 in. w.g. (Heating) and 0 through 1.0 in. w.g. (Cooling) External Static Pressure Range

HEATING

¹ Heating Speed DIP Switch Settings	First Stage Heating Speed - cfm		Second Stage Heating Speed - cfm	
	+24%	1360	1500	
+18%	1295	1425		
+12%	1230	1355		
+6%	1165	1280		
Factory Default	1100	1210		
-6%	1030	1135		
-12%	965	1065		
-18%	900	990		

COOLING

¹ Cooling Speed DIP Switch Settings	First Stage Cooling Speed - cfm				Second Stage Cooling Speed - cfm			
	Low	Medium-Low	Medium-High	² High	Low	Medium-Low	Medium-High	² High
+	1050	1165	1335	1620	1515	1680	1915	2225
Factory Default	955	1060	1215	1480	1390	1545	1735	2060
-	840	945	1090	1290	1220	1385	1580	1825

¹ Cooling and heating speeds are based on a combination of DIP switch settings on the furnace control. Refer to Installation Instructions for specific DIP Switch Settings.

² Factory default setting.

NOTES - The effect of static pressure is included in air volumes shown.

First stage HEAT is approximately 91% of the same second stage HEAT.

First stage COOL (two-stage air conditioning units only) is approximately 70% of the same second stage COOL speed position.

Continuous Fan Only speed is selectable at 28%, 38%, 70% and 100% of the selected second stage cooling speed - minimum 450 cfm.

Lennox Harmony III™ Zone Control Applications - Minimum blower speed is 450 cfm.

SL280UH090V60C BLOWER MOTOR WATTS (COOLING)

¹ Cooling Speed DIP Switch Settings	Motor Watts @ Various External Static Pressures - in. wg.																				
	First Stage										Second Stage										
	0	0.1	0.2	0.3	0.4	0.5	0.6	0.7	0.8	0	0.1	0.2	0.3	0.4	0.5	0.6	0.7	0.8	0.9	1.0	
+ Setting																					
Cooling Speed	Low	75	104	122	142	163	189	214	239	264	219	243	283	317	363	384	424	441	484	511	543
	Med-low	98	128	150	181	205	236	259	289	317	289	333	351	405	444	490	523	564	604	636	668
	Med-High	144	172	205	242	279	306	344	367	396	417	451	507	557	605	655	694	733	788	824	867
	High	245	272	307	359	386	421	447	473	520	709	743	795	855	906	955	1009	1049	1095	1131	1165
Factory Default																					
Cooling Speed	Low	66	88	109	127	150	165	189	209	236	157	185	219	259	290	328	353	394	425	452	480
	Med-low	79	104	127	147	173	201	225	248	268	222	246	284	328	370	397	416	460	490	519	555
	Med-High	106	137	164	190	215	250	278	307	333	307	349	387	435	463	505	553	599	634	674	714
	High	192	224	260	298	338	365	400	438	467	563	597	664	717	756	820	881	907	972	1007	1039
- Setting																					
Cooling Speed	Low	44	65	80	103	121	142	163	180	199	114	141	173	200	230	259	289	318	347	374	401
	Med-low	63	82	105	125	145	166	188	203	227	159	187	226	252	288	323	353	388	419	444	475
	Med-High	82	108	131	151	178	203	229	253	274	236	263	302	344	382	420	443	478	514	548	583
	High	127	159	187	213	252	281	305	338	371	361	393	450	494	537	586	616	672	711	752	787

BLOWER DATA

SL280UH090V60C BLOWER PERFORMANCE (less filter)

SIDE RETURN AIR WITH OPTIONAL RETURN AIR BASE

0 through 0.8 in. w.g. (Heating) and 0 through 1.0 in. w.g. (Cooling) External Static Pressure Range

HEATING

¹ Heating Speed DIP Switch Settings	First Stage Heating Speed - cfm				Second Stage Heating Speed - cfm			
	+24%	1360				1495		
+18%	1290				1420			
+12%	1225				1350			
+6%	1160				1275			
Factory Default	1095				1205			
-6%	1030				1130			
-12%	965				1060			
-18%	900				990			

COOLING

¹ Cooling Speed DIP Switch Settings	First Stage Cooling Speed - cfm				Second Stage Cooling Speed - cfm			
	Low	Medium-Low	Medium-High	² High	Low	Medium-Low	Medium-High	² High
+	1050	1190	1380	1615	1515	1715	1930	2240
Factory Default	970	1090	1245	1485	1380	1560	1755	2070
-	880	985	1095	1285	1215	1400	1580	1830

¹ Cooling and heating speeds are based on a combination of DIP switch settings on the furnace control. Refer to Installation Instructions for specific DIP Switch Settings.

² Factory default setting.

NOTES - The effect of static pressure is included in air volumes shown.

First stage HEAT is approximately 91% of the same second stage HEAT.

First stage COOL (two-stage air conditioning units only) is approximately 70% of the same second stage COOL speed position.

Continuous Fan Only speed is selectable at 28%, 38%, 70% and 100% of the selected second stage cooling speed - minimum 450 cfm.

Lennox Harmony III™ Zone Control Applications - Minimum blower speed is 450 cfm.

SL280UH090V60C BLOWER MOTOR WATTS (COOLING)

¹ Cooling Speed DIP Switch Settings	Motor Watts @ Various External Static Pressures - in. wg.																				
	First Stage										Second Stage										
	0	0.1	0.2	0.3	0.4	0.5	0.6	0.7	0.8	0	0.1	0.2	0.3	0.4	0.5	0.6	0.7	0.8	0.9	1.0	
+ Setting																					
Cooling Speed	Low	74	97	123	139	160	184	212	233	255	194	217	258	292	328	362	396	428	463	484	509
	Med-low	92	121	149	171	200	233	261	283	315	282	320	352	397	428	477	517	550	588	621	655
	Med-High	138	170	198	240	269	300	334	363	395	385	420	474	530	566	626	661	708	750	791	835
	High	216	245	282	333	364	379	430	455	496	658	686	742	808	864	910	960	1006	1043	1087	1116
Factory Default																					
Cooling Speed	Low	63	85	102	123	144	160	183	201	225	145	180	203	239	273	309	335	370	398	432	464
	Med-low	74	100	124	149	164	194	221	245	270	217	247	285	319	360	391	415	459	488	522	556
	Med-High	104	133	162	188	219	246	276	309	328	293	321	385	421	443	494	547	571	605	663	691
	High	178	210	239	281	319	347	380	415	441	518	567	609	683	719	774	831	882	911	976	1026
- Setting																					
Cooling Speed	Low	43	62	80	104	123	144	163	180	199	101	128	163	186	214	245	278	299	332	355	391
	Med-low	61	83	102	124	142	164	188	206	228	158	184	226	254	284	321	347	383	419	446	470
	Med-High	78	108	127	147	172	202	229	252	275	235	265	304	349	382	397	439	470	510	548	583
	High	113	146	174	204	238	269	299	326	364	326	362	413	457	501	546	590	632	680	719	746

BLOWER DATA

SL280UH110V60C BLOWER PERFORMANCE (less filter)

BOTTOM RETURN AIR, RETURN AIR FROM BOTH SIDES OR RETURN AIR FROM BOTTOM AND ONE SIDE

0 through 0.8 in. w.g. (Heating) and 0 through 1.0 in. w.g. (Cooling) External Static Pressure Range

HEATING

¹ Heating Speed DIP Switch Settings	First Stage Heating Speed - cfm		Second Stage Heating Speed - cfm	
	+24%	1690		1855
+18%	1605		1765	
+12%	1525		1675	
+6%	1445		1585	
Factory Default	1360		1495	
-6%	1280		1405	
-12%	1200		1315	
-18%	1115		1230	

COOLING

¹ Cooling Speed DIP Switch Settings	First Stage Cooling Speed - cfm				Second Stage Cooling Speed - cfm			
	Low	Medium-Low	Medium-High	² High	Low	Medium-Low	Medium-High	² High
+	1060	1220	1330	1565	1535	1710	1910	2210
Factory Default	970	1075	1180	1430	1400	1565	1715	2015
-	875	980	1070	1255	1260	1400	1560	1815

¹ Cooling and heating speeds are based on a combination of DIP switch settings on the furnace control. Refer to Installation Instructions for specific DIP Switch Settings.

² Factory default setting.

NOTES - The effect of static pressure is included in air volumes shown.

First stage HEAT is approximately 91% of the same second stage HEAT.

First stage COOL (two-stage air conditioning units only) is approximately 70% of the same second stage COOL speed position.

Continuous Fan Only speed is selectable at 28%, 38%, 70% and 100% of the selected second stage cooling speed - minimum 450 cfm.

Lennox Harmony III™ Zone Control Applications - Minimum blower speed is 450 cfm.

SL280UH110V60C BLOWER MOTOR WATTS (COOLING)

¹ Cooling Speed DIP Switch Settings	Motor Watts @ Various External Static Pressures - in. wg.																				
	First Stage										Second Stage										
	0	0.1	0.2	0.3	0.4	0.5	0.6	0.7	0.8	0	0.1	0.2	0.3	0.4	0.5	0.6	0.7	0.8	0.9	1.0	
+ Setting																					
Cooling Speed	Low	89	116	144	159	201	222	245	274	298	234	259	304	360	385	408	451	484	530	553	596
	Med-low	108	135	170	196	228	259	286	320	343	297	340	380	409	459	502	539	570	616	660	702
	Med-High	136	164	202	236	269	300	331	370	392	390	420	497	530	585	630	677	727	777	815	854
	High	252	275	329	366	396	441	472	493	537	702	734	780	841	907	957	1013	1048	1100	1124	1148
Factory Default																					
Cooling Speed	Low	71	98	118	139	166	184	207	237	262	179	203	244	281	329	356	388	425	453	480	519
	Med-low	86	118	138	154	187	212	237	266	291	223	251	288	342	377	399	449	474	513	548	578
	Med-High	99	132	160	184	222	254	277	308	343	299	341	384	420	472	497	540	599	632	674	709
	High	192	227	258	299	333	376	409	434	471	493	540	591	653	705	760	829	869	919	965	1005
- Setting																					
Cooling Speed	Low	60	78	104	122	144	168	187	205	226	133	162	191	225	262	289	324	357	385	410	436
	Med-low	68	94	116	132	150	177	203	220	251	163	189	224	263	292	333	364	392	431	458	473
	Med-High	80	109	128	151	174	204	229	252	279	224	251	293	326	370	398	439	467	491	531	570
	High	131	165	196	226	265	300	336	356	397	365	406	460	511	558	603	643	705	743	792	835

BLOWER DATA

SL280UH110V60C BLOWER PERFORMANCE (less filter)

SINGLE SIDE RETURN AIR

0 through 0.8 in. w.g. (Heating) and 0 through 1.0 in. w.g. (Cooling) External Static Pressure Range

HEATING

¹ Heating Speed DIP Switch Settings	First Stage Heating Speed - cfm				Second Stage Heating Speed - cfm			
	+24%	1640				1805		
+18%	1560				1715			
+12%	1480				1630			
+6%	1400				1545			
Factory Default	1325				1455			
-6%	1245				1370			
-12%	1165				1280			
-18%	1085				1195			

COOLING

¹ Cooling Speed DIP Switch Settings	First Stage Cooling Speed - cfm				Second Stage Cooling Speed - cfm			
	Low	Medium-Low	Medium-High	² High	Low	Medium-Low	Medium-High	² High
+	1020	1160	1285	1550	1505	1690	1855	2125
Factory Default	940	1050	1155	1400	1375	1525	1685	1935
-	835	945	1020	1250	1235	1380	1505	1730

¹ Cooling and heating speeds are based on a combination of DIP switch settings on the furnace control. Refer to Installation Instructions for specific DIP Switch Settings.

² Factory default setting.

NOTES - The effect of static pressure is included in air volumes shown.

First stage HEAT is approximately 91% of the same second stage HEAT.

First stage COOL (two-stage air conditioning units only) is approximately 70% of the same second stage COOL speed position.

Continuous Fan Only speed is selectable at 28%, 38%, 70% and 100% of the selected second stage cooling speed - minimum 450 cfm.

Lennox Harmony III™ Zone Control Applications - Minimum blower speed is 450 cfm.

SL280UH110V60C BLOWER MOTOR WATTS (COOLING)

¹ Cooling Speed DIP Switch Settings	Motor Watts @ Various External Static Pressures - in. wg.																				
	First Stage										Second Stage										
	0	0.1	0.2	0.3	0.4	0.5	0.6	0.7	0.8	0	0.1	0.2	0.3	0.4	0.5	0.6	0.7	0.8	0.9	1.0	
+ Setting																					
Cooling Speed	Low	84	116	131	156	193	216	238	265	292	218	245	293	336	378	415	454	488	516	557	601
	Med-low	99	128	156	195	216	245	280	309	335	292	333	381	412	454	490	535	577	618	662	704
	Med-High	128	157	193	226	266	293	321	360	387	373	412	475	518	573	617	661	710	771	800	857
	High	238	274	303	354	388	413	460	493	524	675	717	786	854	898	983	1017	1071	1112	1157	1186
Factory Default																					
Cooling Speed	Low	73	96	121	140	154	184	206	228	255	166	192	237	271	319	345	382	419	459	480	515
	Med-low	81	108	133	156	175	207	230	253	285	220	248	290	328	372	405	447	474	513	540	577
	Med-High	92	123	148	185	209	246	277	302	331	290	328	374	415	452	487	536	576	605	653	701
	High	175	202	247	285	327	364	388	426	457	477	511	590	647	690	739	789	843	901	947	998
- Setting																					
Cooling Speed	Low	56	74	98	116	141	157	179	199	216	129	157	198	221	259	298	325	354	387	418	451
	Med-low	69	92	111	132	155	174	197	214	243	166	186	232	268	289	339	365	389	429	454	479
	Med-High	78	107	128	149	172	203	230	249	278	204	225	282	312	353	383	406	452	489	519	552
	High	124	157	186	220	261	291	321	352	386	326	372	427	464	526	566	608	658	706	762	808

BLOWER DATA

SL280UH110V60C BLOWER PERFORMANCE (less filter)

SIDE RETURN AIR WITH OPTIONAL RETURN AIR BASE

0 through 0.8 in. w.g. (Heating) and 0 through 1.0 in. w.g. (Cooling) External Static Pressure Range

HEATING

¹ Heating Speed DIP Switch Settings	First Stage Heating Speed - cfm				Second Stage Heating Speed - cfm			
	+24%	1635				1800		
+18%	1555				1710			
+12%	1475				1625			
+6%	1395				1535			
Factory Default	1320				1450			
-6%	1240				1365			
-12%	1160				1275			
-18%	1080				1190			

COOLING

¹ Cooling Speed DIP Switch Settings	First Stage Cooling Speed - cfm				Second Stage Cooling Speed - cfm			
	Low	Medium-Low	Medium-High	² High	Low	Medium-Low	Medium-High	² High
+	1085	1160	1270	1490	1595	1660	1840	2115
Factory Default	1010	1040	1160	1375	1470	1535	1655	1940
-	900	955	1025	1205	1315	1365	1510	1735

¹ Cooling and heating speeds are based on a combination of DIP switch settings on the furnace control. Refer to Installation Instructions for specific DIP Switch Settings.

² Factory default setting.

NOTES - The effect of static pressure is included in air volumes shown.

First stage HEAT is approximately 91% of the same second stage HEAT.

First stage COOL (two-stage air conditioning units only) is approximately 70% of the same second stage COOL speed position.

Continuous Fan Only speed is selectable at 28%, 38%, 70% and 100% of the selected second stage cooling speed - minimum 450 cfm.

Lennox Harmony III™ Zone Control Applications - Minimum blower speed is 450 cfm.

SL280UH110V60C BLOWER MOTOR WATTS (COOLING)

¹ Cooling Speed DIP Switch Settings	Motor Watts @ Various External Static Pressures - in. wg.																				
	First Stage										Second Stage										
	0	0.1	0.2	0.3	0.4	0.5	0.6	0.7	0.8	0	0.1	0.2	0.3	0.4	0.5	0.6	0.7	0.8	0.9	1.0	
+ Setting																					
Cooling Speed	Low	81	112	131	153	183	207	237	260	286	221	247	300	343	371	416	441	492	518	557	595
	Med-low	87	120	144	171	201	227	261	291	317	245	279	326	369	405	441	488	527	557	605	642
	Med-High	131	165	193	219	257	293	317	355	379	315	354	411	463	508	558	603	652	693	741	793
	High	196	225	267	307	342	379	411	451	475	541	591	646	696	744	802	859	911	961	1007	1054
Factory Default																					
Cooling Speed	Low	64	92	111	133	151	177	203	228	254	170	200	230	270	311	348	383	411	435	474	503
	Med-low	72	99	123	144	164	198	224	246	270	196	220	268	304	334	372	399	446	471	500	538
	Med-High	97	130	150	185	212	239	276	302	328	243	278	328	370	407	446	482	531	569	604	652
	High	142	176	207	245	286	322	349	384	418	383	427	478	529	592	638	687	728	780	829	872
- Setting																					
Cooling Speed	Low	53	74	93	113	133	153	175	194	215	115	147	176	207	248	277	310	346	376	403	432
	Med-low	57	79	99	124	143	164	185	207	230	136	164	201	236	273	308	342	374	412	440	462
	Med-High	81	109	133	151	173	205	224	254	280	184	214	247	290	329	365	402	431	466	489	530
	High	101	135	162	191	224	258	292	320	345	272	317	355	396	446	488	529	574	612	650	707

BLOWER DATA

SL280UH135V60D BLOWER PERFORMANCE (less filter)

BOTTOM RETURN AIR, RETURN AIR FROM BOTH SIDES OR RETURN AIR FROM BOTTOM AND ONE SIDE

0 through 0.8 in. w.g. (Heating) and 0 through 1.0 in. w.g. (Cooling) External Static Pressure Range

HEATING

¹ Heating Speed DIP Switch Settings	First Stage Heating Speed - cfm				Second Stage Heating Speed - cfm			
	+24%	1875				2065		
+18%	1785				1965			
+12%	1695				1865			
+6%	1605				1765			
Factory Default	1515				1665			
-6%	1425				1565			
-12%	1330				1465			
-18%	1240				1365			

COOLING

¹ Cooling Speed DIP Switch Settings	First Stage Cooling Speed - cfm				Second Stage Cooling Speed - cfm			
	Low	Medium-Low	Medium-High	² High	Low	Medium-Low	Medium-High	² High
+	1025	1120	1325	1650	1500	1600	1840	2235
Factory Default	965	1015	1180	1490	1420	1510	1700	2110
-	875	930	1060	1350	1225	1320	1505	1840

¹ Cooling and heating speeds are based on a combination of DIP switch settings on the furnace control. Refer to Installation Instructions for specific DIP Switch Settings.

² Factory default setting.

NOTES - The effect of static pressure is included in air volumes shown.

First stage HEAT is approximately 91% of the same second stage HEAT.

First stage COOL (two-stage air conditioning units only) is approximately 70% of the same second stage COOL speed position.

Continuous Fan Only speed is selectable at 28%, 38%, 70% and 100% of the selected second stage cooling speed - minimum 450 cfm.

Lennox Harmony III™ Zone Control Applications - Minimum blower speed is 450 cfm.

SL280UH135V60D BLOWER MOTOR WATTS (COOLING)

¹ Cooling Speed DIP Switch Settings	Motor Watts @ Various External Static Pressures - in. wg.																				
	First Stage										Second Stage										
	0	0.1	0.2	0.3	0.4	0.5	0.6	0.7	0.8	0	0.1	0.2	0.3	0.4	0.5	0.6	0.7	0.8	0.9	1.0	
+ Setting																					
Cooling Speed	Low	72	99	123	145	177	204	228	253	277	180	208	244	299	334	374	408	432	478	511	539
	Med-low	80	108	137	164	194	224	252	280	308	214	249	291	340	384	422	450	493	530	579	619
	Med-High	119	154	180	227	259	298	328	363	392	309	359	404	464	509	560	622	661	715	757	809
	High	239	271	320	370	394	439	477	513	559	655	683	774	832	888	957	1022	1053	1122	1161	1206
Factory Default																					
Cooling Speed	Low	52	79	95	120	147	167	188	215	238	127	161	197	238	277	316	349	386	412	457	493
	Med-low	63	87	116	137	158	188	210	239	262	160	194	229	280	317	350	395	431	451	502	540
	Med-High	86	115	152	174	203	236	270	298	328	227	266	333	369	373	405	445	541	579	601	642
	High	160	194	229	278	318	359	394	429	455	468	521	580	647	716	763	819	872	934	994	1053
- Setting																					
Cooling Speed	Low	45	65	87	107	128	152	170	191	210	103	133	167	199	235	268	294	325	366	391	425
	Med-low	50	70	95	120	140	166	185	208	228	109	143	178	213	247	283	320	359	380	421	455
	Med-High	71	97	123	147	175	204	228	254	279	171	203	235	294	328	370	401	439	478	515	543
	High	127	160	196	232	265	299	334	369	403	294	343	402	457	510	576	619	673	720	781	835

BLOWER DATA

SL280UH135V60D BLOWER PERFORMANCE (less filter)

SINGLE SIDE RETURN AIR

0 through 0.8 in. w.g. (Heating) and 0 through 1.0 in. w.g. (Cooling) External Static Pressure Range

HEATING

¹ Heating Speed DIP Switch Settings	First Stage Heating Speed - cfm	Second Stage Heating Speed - cfm
+24%	1850	2035
+18%	1760	1935
+12%	1670	1835
+6%	1580	1740
Factory Default	1490	1640
-6%	1400	1540
-12%	1310	1445
-18%	1225	1345

COOLING

¹ Cooling Speed DIP Switch Settings	First Stage Cooling Speed - cfm				Second Stage Cooling Speed - cfm			
	Low	Medium-Low	Medium-High	² High	Low	Medium-Low	Medium-High	² High
+	1030	1105	1305	1635	1525	1600	1840	2255
Factory Default	960	1005	1175	1480	1355	1435	1635	2035
-	845	925	1050	1340	1240	1315	1520	1850

¹ Cooling and heating speeds are based on a combination of DIP switch settings on the furnace control. Refer to Installation Instructions for specific DIP Switch Settings.

² Factory default setting.

NOTES - The effect of static pressure is included in air volumes shown.

First stage HEAT is approximately 91% of the same second stage HEAT.

First stage COOL (two-stage air conditioning units only) is approximately 70% of the same second stage COOL speed position.

Continuous Fan Only speed is selectable at 28%, 38%, 70% and 100% of the selected second stage cooling speed - minimum 450 cfm.

Lennox Harmony III™ Zone Control Applications - Minimum blower speed is 450 cfm.

SL280UH135V60D BLOWER MOTOR WATTS (COOLING)

¹ Cooling Speed DIP Switch Settings	Motor Watts @ Various External Static Pressures - in. wg.																				
	First Stage										Second Stage										
	0	0.1	0.2	0.3	0.4	0.5	0.6	0.7	0.8	0	0.1	0.2	0.3	0.4	0.5	0.6	0.7	0.8	0.9	1.0	
+ Setting																					
Cooling Speed	Low	66	97	120	138	165	195	220	245	279	189	220	259	298	333	378	410	441	486	517	543
	Med-low	82	111	140	161	190	218	255	269	306	224	255	298	354	389	422	455	499	549	571	616
	Med-High	114	148	177	218	254	288	320	359	381	317	359	418	459	511	557	615	655	701	747	795
	High	233	268	307	357	396	430	475	503	544	668	704	766	831	898	941	995	1048	1103	1144	1176
Factory Default																					
Cooling Speed	Low	49	76	97	121	146	170	198	223	246	130	166	200	238	281	318	350	398	425	462	490
	Med-low	58	89	109	130	161	193	221	238	267	163	185	240	290	318	347	398	432	460	500	538
	Med-High	76	109	135	170	200	231	268	290	324	233	281	333	368	408	456	499	539	591	644	693
	High	162	195	230	282	318	356	391	425	457	484	529	603	651	721	783	832	898	951	994	1051
- Setting																					
Cooling Speed	Low	41	60	86	104	129	149	169	190	212	94	130	161	189	221	259	288	317	355	390	421
	Med-low	50	72	96	120	139	160	184	201	235	114	147	177	211	256	290	330	354	385	422	453
	Med-High	73	101	123	147	167	196	221	250	274	177	207	245	291	331	370	413	431	475	509	543
	High	118	151	181	231	261	303	327	363	399	328	369	431	477	535	580	638	683	723	777	827

On-Board Links

Note: In *icomfort™* systems with a conventional outdoor unit (non-communicating), the on-board clippable links must be set to properly configure the system.

⚠ WARNING

Carefully review all configuration information provided. Failure to properly set DIP switches, jumpers and on-board links can result in improper operation!

On-Board Link W914 Dehum or Harmony (R to DS)

On-board link W914, is a clippable connection between terminals R and DS on the integrated control. W914 must be cut when the furnace is installed with either the Harmony III™ zone control or a thermostat which features humidity control. If the link is left intact the PMW signal from the Harmony III control will be blocked and also lead to control

damage. Refer to table 12 for operation sequence in applications including SL280UHV, a thermostat which features humidity control and a single-speed outdoor unit. Table 13 gives the operation sequence in applications with a two-speed outdoor unit.

On-Board Link W951 Heat Pump (R to O)

On-board link W951 is a clippable connection between terminals R and O on the integrated control. W951 must be cut when the furnace is installed in applications which include a heat pump unit and a thermostat which features dual fuel use. If the link is left intact, terminal "O" will remain energized eliminating the HEAT MODE in the heat pump.

On-Board Link W915 2 Stage Compr (Y1 to Y2)

On-board link W915 is a clippable connection between terminals Y1 and Y2 on the integrated control. W915 must be cut if two-stage cooling will be used. If the Y1 to Y2 link is not cut the outdoor unit will operate in second-stage cooling only.

**TABLE 12
OPERATING SEQUENCE**

SL280UHV, Non-Communicating Thermostat with Humidity Control Feature and Single-Speed Outdoor Unit

OPERATING SEQUENCE		SYSTEM DEMAND						SYSTEM RESPONSE		
System Condition	Step	Thermostat Demand				Relative Humidity		Compressor	Blower CFM (COOL)	Comments
		Y1	O	G	W1	Status	D			
<i>NO CALL FOR DEHUMIDIFICATION</i>										
Normal Operation	1	On	On	On		Acceptable	24 VAC	High	100%	Compressor and indoor blower follow thermostat demand
<i>BASIC MODE (only active on a Y1 thermostat demand)</i>										
Normal Operation	1	On	On	On		Acceptable	24 VAC	High	100%	ComfortSense® 7000 thermostat energizes Y1 and de-energizes D on a call for de-humidification
Dehumidification Call	2	On	On	On		Demand	0 VAC	High	70%*	
<i>PRECISION MODE (operates independent of a Y1 thermostat demand)</i>										
Normal Operation	1	On	On	On		Acceptable	24 VAC	High	100%	Dehumidification mode begins when humidity is greater than set point
Dehumidification call	2	On	On	On		Demand	0 VAC	High	70%*	
Dehumidification call ONLY	1	On	On	On		Demand	0 VAC	High	70%*	ComfortSense® 7000 thermostat will try to maintain room humidity setpoint by allowing the room space to maintain a cooler room thermostat setpoint**
Jumpers at indoor unit with a single stage outdoor unit With Condensing unit - Cut W914 (R to DS) on SureLight® control With Heat Pump - Cut W914 (R to DS) & W951 (R to O) on SureLight® control										

Use Dave Lennox ComfortSense® 7000 thermostat Y2081 4 heat / 2 cool for this application

*Dehumidification blower speed is 70% of COOL speed for all units.

**In Precision mode, ComfortSense® 7000 thermostat will maintain room temperature up to 2 °F (1.2°C) cooler than room setting.

**TABLE 13
OPERATING SEQUENCE**

SL280UHV, Non-Communicating Thermostat with Humidity Control Feature and Two-Speed Outdoor Unit

OPERATING SEQUENCE		SYSTEM DEMAND								SYSTEM RESPONSE			
System Condition	Step	Thermostat Demand						Relative Humidity		Compressor	Blower CFM (COOL)	Comments	
		Y1	Y2	O	G	W1	W2	Status	D				
NO CALL FOR DEHUMIDIFICATION													
Normal Operation - Y1	1	On		On	On			Acceptable	24 VAC	Low	70%*	Compressor and indoor blower follow thermostat demand	
Normal Operation - Y2	2	On	On	On	On			Acceptable	24 VAC	High	100%		
ROOM THERMOSTAT CALLS FOR FIRST STAGE COOLING													
<i>BASIC MODE (only active on a Y1 thermostat demand)</i>													
Normal Operation	1	On		On	On			Acceptable	24 VAC	Low	70%*	ComfortSense® 7000 thermostat energizes Y2 and de-energizes D on a call for de-humidification	
Dehumidification Call	2	On	On	On	On			Demand	0 VAC	High	70%**		
<i>PRECISION MODE (operates independent of a Y1 thermostat demand)</i>													
Normal Operation	1	On		On	On			Acceptable	24 VAC	Low	70%*	Dehumidification mode begins when humidity is greater than set point	
Dehumidification call	2	On	On	On	On			Demand	0 VAC	High	70%**		
Dehumidification call ONLY	1	On	On	On	On			Demand	0 VAC	High	70%**	ComfortSense® 7000 thermostat will try to maintain room humidity setpoint by allowing the room space to maintain a cooler room thermostat setpoint***	
ROOM THERMOSTAT CALLS FOR FIRST AND SECOND STAGE COOLING													
<i>BASIC MODE (only active on a Y1 thermostat demand)</i>													
Normal Operation	1	On	On	On	On			Acceptable	24 VAC	High	100%	ComfortSense® 7000 thermostat energizes Y2 and de-energizes D on a call for de-humidification	
Dehumidification Call	2	On	On	On	On			Demand	0 VAC	High	70%**		
<i>PRECISION MODE (operates independent of a Y1 thermostat demand)</i>													
Normal Operation	1	On		On	On			Acceptable	24 VAC	Low	70%*	Dehumidification mode begins when humidity is greater than set point	
Dehumidification call	2	On	On	On	On			Demand	0 VAC	High	70%**		
Dehumidification call ONLY	1	On	On	On	On			Demand	0 VAC	High	70%**	ComfortSense® 7000 thermostat will try to maintain room humidity setpoint by allowing the room space to maintain a cooler room thermostat setpoint***	
		Jumpers at indoor unit with a two stage outdoor unit Cut factory jumper from Y1 to Y2 or cut W915 (Y1 to Y2) With Condensing unit - Cut W914 (R to DS) on SureLight® control With Heat Pump - Cut W914 (R to DS) & W951 (R to O) on SureLight® control											ComfortSense® 7000 thermostat will try to maintain room humidity setpoint by allowing the room space to maintain a cooler room thermostat setpoint***

Use Dave Lennox ComfortSense® 7000 thermostat Y2081 4 heat / 2 cool for this application.

*Normal operation first stage cooling blower speed is 70% COOL speed.

**Dehumidification blower speed is, reduced to 70% of COOL.

***In Precision mode, ComfortSense® 7000 thermostat will maintain room temperature up to 2 °F (1.2°C) cooler than room setting.

B- Indoor Blower Motor

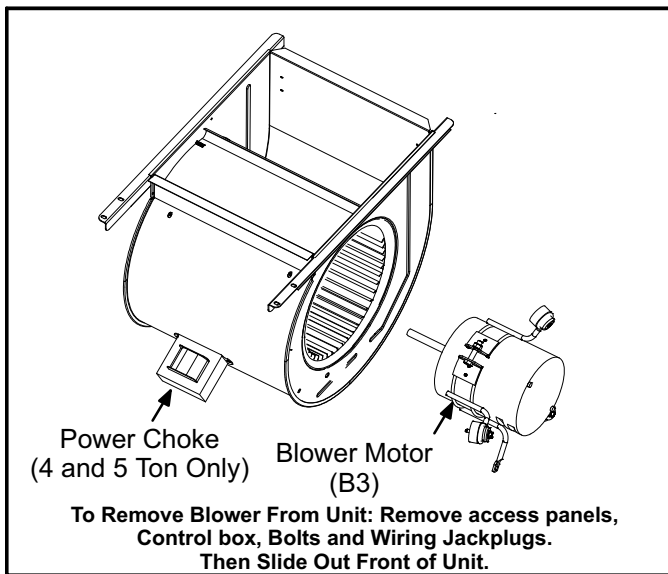

FIGURE 6

⚠ WARNING

During blower operation, the ECM motor emits energy that may interfere with pacemaker operation. Interference is reduced by both the sheet metal cabinet and distance.

The motor communicates with the integrated control via a 2-way serial connection. The motor receives all necessary functional parameters from the integrated control and does not rely on a factory program like traditional variable speed motors. SL280UHV units use a three-phase, electronically controlled D.C. brushless motor (controller converts single phase a.c. to three phase D.C.), with a permanent-magnet-type rotor (figure 7). Because this motor has a permanent magnet rotor it does not need brushes like conventional D.C. motors.

The stator windings are split into three poles which are electrically connected to the controller. This arrangement allows motor windings to turn on and off in sequence by the controller.

⚠ IMPORTANT

Earlier ECM motors used on other Lennox furnace models are not interchangeable with motors used on the SL280UH furnace line.

A solid-state controller is permanently attached to the motor. The controller is primarily an A.C. to D.C. converter. Converted D.C. power is used to drive the motor. The controller contains a microprocessor which monitors varying conditions inside the motor (such as motor workload).

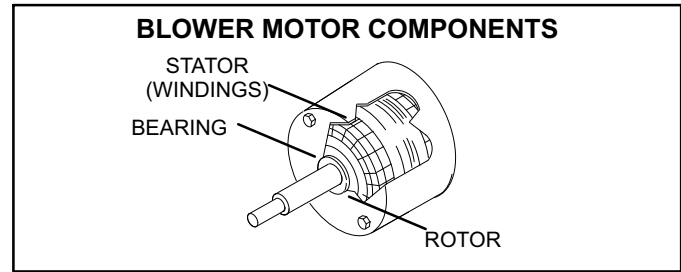

FIGURE 7

The controller uses sensing devices to sense what position the rotor is in at any given time. By sensing the position of the rotor and then switching the motor windings on and off in sequence, the rotor shaft turns the blower.

All SL280UHV blower motors use single phase power. An external run capacitor is not used. The motor uses permanently lubricated ball-type bearings.

Internal Operation

The motor is controlled via serial communication between the integrated control on the furnace and the controller attached to the motor shell. The messages sent back and forth between the two controls serve to communicate rotational direction, demand, motor size, current draw, torque, and rpm, among other variables.

Motor rpm is continually adjusted internally to maintain constant static pressure against the blower wheel. The controller monitors the static work load on the motor and motor amp-draw to determine the amount of rpm adjustment. Blower rpm may be adjusted any amount in order to maintain a constant cfm as shown in Blower Ratings Tables. The cfm remains relatively stable over a broad range of static pressure. Since the blower constantly adjusts rpm to maintain a specified cfm, motor rpm is not rated. Hence, the terms "cool speed", "heat speed" or "speed tap" in this manual, on the unit wiring diagram and on blower B3, refer to blower cfm regardless of motor rpm.

Initial Power Up

When line voltage is applied to B3, there will be a large inrush of power lasting less than 1/4 second. This inrush charges a bank of DC filter capacitors inside the controller. If the disconnect switch is bounced when the disconnect is closed, the disconnect contacts may become welded. Try not to bounce the disconnect switch when applying power to the unit.

Motor Start-Up

When B3 begins start-up, the motor gently vibrates back and forth for a moment. This is normal. During this time the electronic controller is determining the exact position of the rotor. Once the motor begins turning, the controller slowly eases the motor up to speed (this is called "soft-start"). The motor may take as long as 10-15 seconds to reach full speed. If the motor does not reach 200 rpm within 13 seconds, the motor shuts down. Then the motor will immediately attempt a restart. The shutdown feature provides protection in case of a frozen bearing or blocked blower wheel. The motor may attempt to start eight times. If the motor does not start after the eighth try, the controller locks out. Reset controller by momentarily turning off power to unit.

The DC filter capacitors inside the controller are connected electrically to the motor supply wires. The capacitors take approximately 5 minutes to discharge when the disconnect is opened. For this reason it is necessary to wait at least 5 minutes after turning off power to the unit before attempting to service motor.

⚠ DANGER	
	Disconnect power from unit and wait at least five minutes to allow capacitors to discharge before attempting to service motor. Failure to wait may cause personal injury or death.

Power Choke (L13)

A choke coil is used on SL280UHV 4 and 5 ton units equipped with 1 hp motors. The choke is located on the blower housing and is used to suppress transient current spikes.

Troubleshooting Motor Operation

To verify motor operation see steps below and figures 8 and 9.

- 1- Remove J48 (5 pin power plug) from P48 on the motor.
- 2- With the power on at the furnace and door switch depressed, use a test meter to verify 120V between pins 4 and 5 on J48.
- 3- Reconnect J48 to P48 on the motor.
- 4- Remove J49 (4 pin low voltage connector) from P49 on the motor.
- 5- Using test jumpers, apply 24V to pins 3 and 4 on P49 on the motor.

Note: Do not apply 24V to pins 2 and 4 on P49. Doing so will cause permanent damage to the motor.

- 6- Motor should run at 75%.
- 7- Test is complete. Remove jumpers and reconnect plugs.

Another option is to use the TECMate PRO motor tester with the 16 to 4 pin adaptor. The use of the TECMate PRO isolates the motor from the integrated control. Follow the instructions provided with the kit. If the motor runs do not replace.

BLOWER B3 HARNESS CONNECTORS

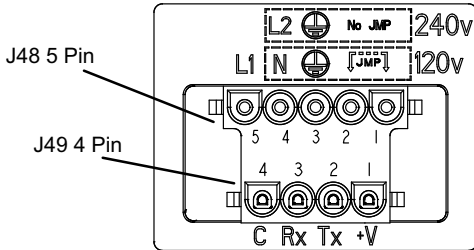
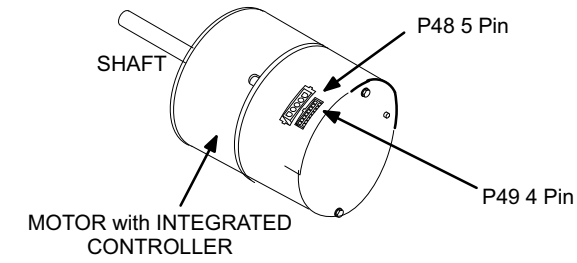

J49 4 Pin Control Connector	
PIN	DESCRIPTION
1	12V INPUT
2	SERIAL DATA OUTPUT
3	SERIAL DATA INPUT
4	COMMON

J48 5 Pin Line Voltage Connector	
PIN	DESCRIPTION
1	JUMPER PIN 1 TO PIN 2 FOR 120VAC LINE INPUT ONLY ***
2	
3	CHASSIS GROUND
4	AC LINE
5	AC LINE

FIGURE 8

BLOWER B3 HARNESS CONNECTORS

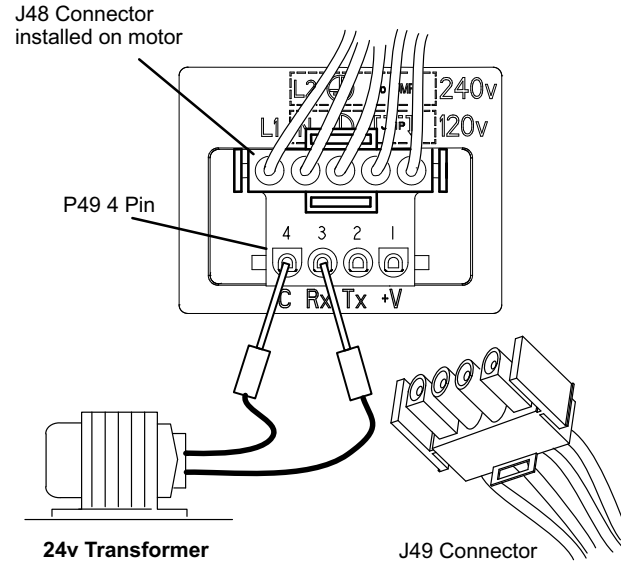
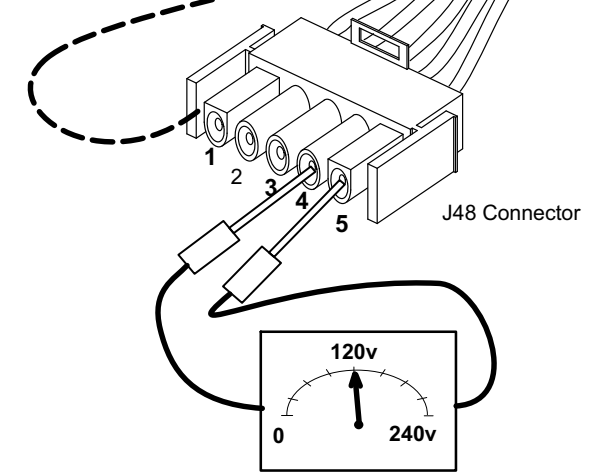
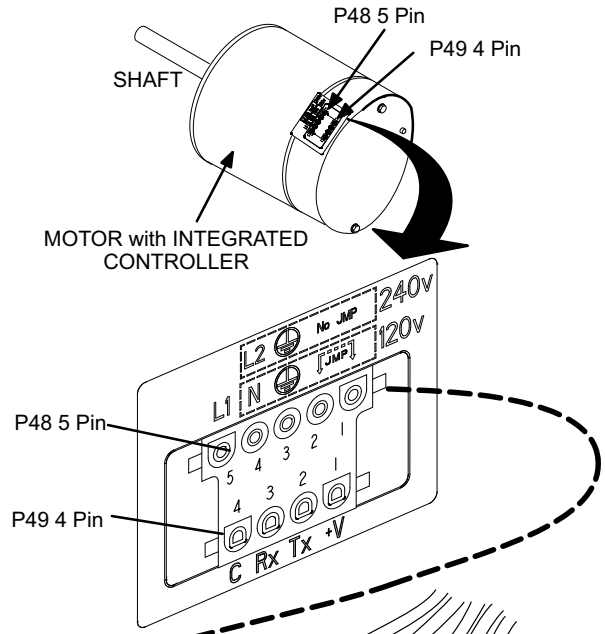

FIGURE 9

Troubleshooting Motor Windings

Ensure that motor windings are not damaged by performing the following tests:

NOTE - If your ohm meter is not an auto-ranging type, set it to the highest ohm scale (100k ohms or greater) before performing tests.

Table 2
Ohm Meter Range

Scale	Measurement Range	
	in words	ohms
2M	two megohm -- two million ohms	0-2,000,000
200k	two hundred kilohm -- two hundred thousand ohms	0-200,000
20k	twenty kilohm -- twenty thousand ohms	0-20,000
2k	two kilohm -- two thousand ohms	0-2,000
200	two hundred ohm	0-200

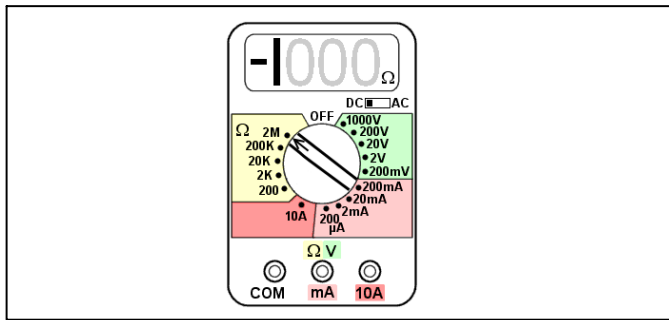

FIGURE 10

TEST A

Measure the resistance between each of the three motor leads (3-pin plug) and the unpainted part of the end shield.

If the winding resistance to ground is <100k ohms, replace the motor and control module. If the resistance to ground is >100k, the motor windings are fine. Proceed to Test B.

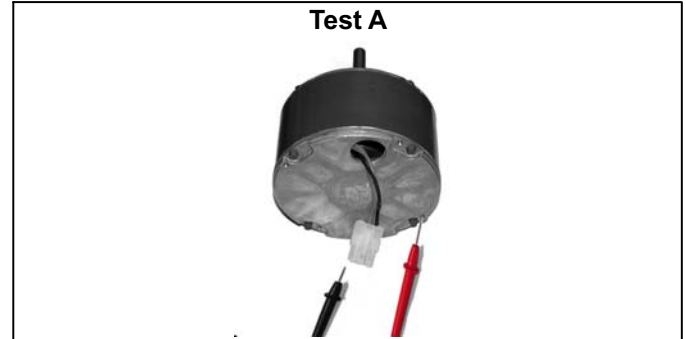

FIGURE 11

TEST B

Use an ohmmeter to measure the motor phase-to-phase resistance by checking these combinations of the the 3-pin motor plug. For the purpose of this test, start at either end of the connector as lead 1.

- 1 - The lead-to-lead resistance across any two leads should be less than 20 ohms.
- 2 - Each lead-to-lead resistance should be the same.

If the measured resistance is greater than 20 ohms, replace the motor and control module.

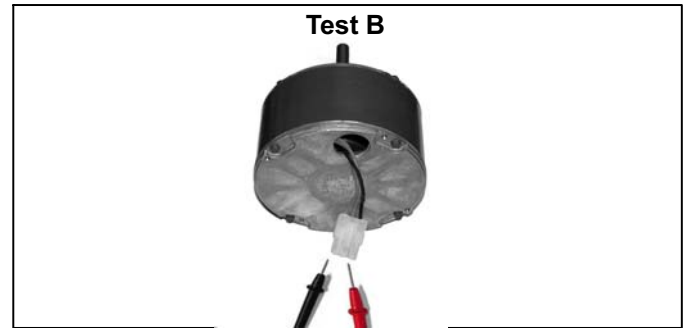

FIGURE 12

C- Heating Components

1. Ignitor

The SureLight® ignitor is made of durable silicon nitride. Ignitor longevity is enhanced by controlling voltage to the ignitor. The integrated control provides a regulated 120 volts to the ignitor for a consistent ignition and long ignitor life. Ohm value should be 39 to 70. See figure 13 for ignitor location and figure 14 for ignitor check out.

NOTE - The SL280UHV(X) furnace contains electronic components that are polarity sensitive. Make sure that the furnace is wired correctly and is properly grounded.

2. Flame Sensor

A flame sensor is located on the left side of the burner support. See figure 13. The sensor tip protrudes into the flame envelope of the left-most burner. The sensor can be removed for service without removing any part of the burners. During operation, flame is sensed by current passed through the flame and sensing electrode. The SureLight control allows the gas valve to remain open as long as flame signal is sensed. To check flame sense signal use the push-button found on the integrated control and go to Field Test Mode. The menu will display the flame signal. See table 14 for flame signal.

TABLE 14
Flame Signal in Microamps

Normal	Low	Drop Out
2.6 or greater	2.5 or less	1.1

3. Gas Valve

The valve (figure 17 or 18) is internally redundant to assure safety shut-off. If the gas valve must be replaced, the same type valve must be used.

24VAC terminals and gas control knob are located on the valve. A wire harness connects the terminals from the gas valve to the electronic ignition control. 24V applied to the terminals energizes the valve.

Inlet and outlet pressure taps are located on the valve. A regulator adjustment screw is located on the valve.

LPG change over kits are available from Lennox. Kits include burner orifices and a gas valve.

4. Flame Rollout Switches (S47)

Flame rollout switch is a high temperature limit located on top of the burner box, one on each side.- See figure 13. The limit is a N.C. SPST manual-reset limit connected in series with the secondary limit S21. When S47 senses rollout, the

circuit breaks and the ignition control immediately stops ignition and closes the gas valve. Rollout can be caused by a blocked heat exchanger, flue or lack of combustion air. The switch is factory set to trip (open) at 210°F and cannot be adjusted. The switch can be manually reset. To manually reset a tripped switch, push the reset button located on the control.

5. Burners

All units use inshot burners. Burners are factory set and require no adjustment. Always operate the unit with the burner box front panel in place. Each burner uses an orifice (see table 19 for orifice size) that is precisely matched to the burner input. Burners can be removed as a one piece assembly for service. If burner assembly has been removed, it is critical to align center of each burner to the center of the clamshell when re-installing. See more detail in Section VI- MAINTENANCE sub-section E- Heat Exchanger and Burners.

6. Primary Limit Control (S10)

The primary limit (S10) is located in the heating vestibule panel. When excess heat is sensed in the heat exchanger, the limit will open. If the limit is open, the furnace control energizes the supply air blower and closes the gas valve. The limit automatically resets when unit temperature returns to normal. The switch must reset within three minutes or the SureLight control will go into Watch guard for one hour. The switch is factory set and cannot be adjusted. The switch may have a different set point for each unit model number. See Lennox Repair Parts Handbook if limit switch must be replaced,

7. Secondary Limit Controls (S21)

The secondary limit (S21) is located in the blower compartment on the back side of the blower housing. SL280UHV units require two secondary limits. When excess heat is sensed in the blower compartment, the limit will open. If the limit is open, the furnace control energizes the supply air blower and closes the gas valve. The limit automatically resets when unit temperature returns to normal. The switch must reset within three minutes or the SureLight control will go into Watch guard for one hour. The switch is factory set and cannot be adjusted.

SL280UHV HEATING COMPONENTS

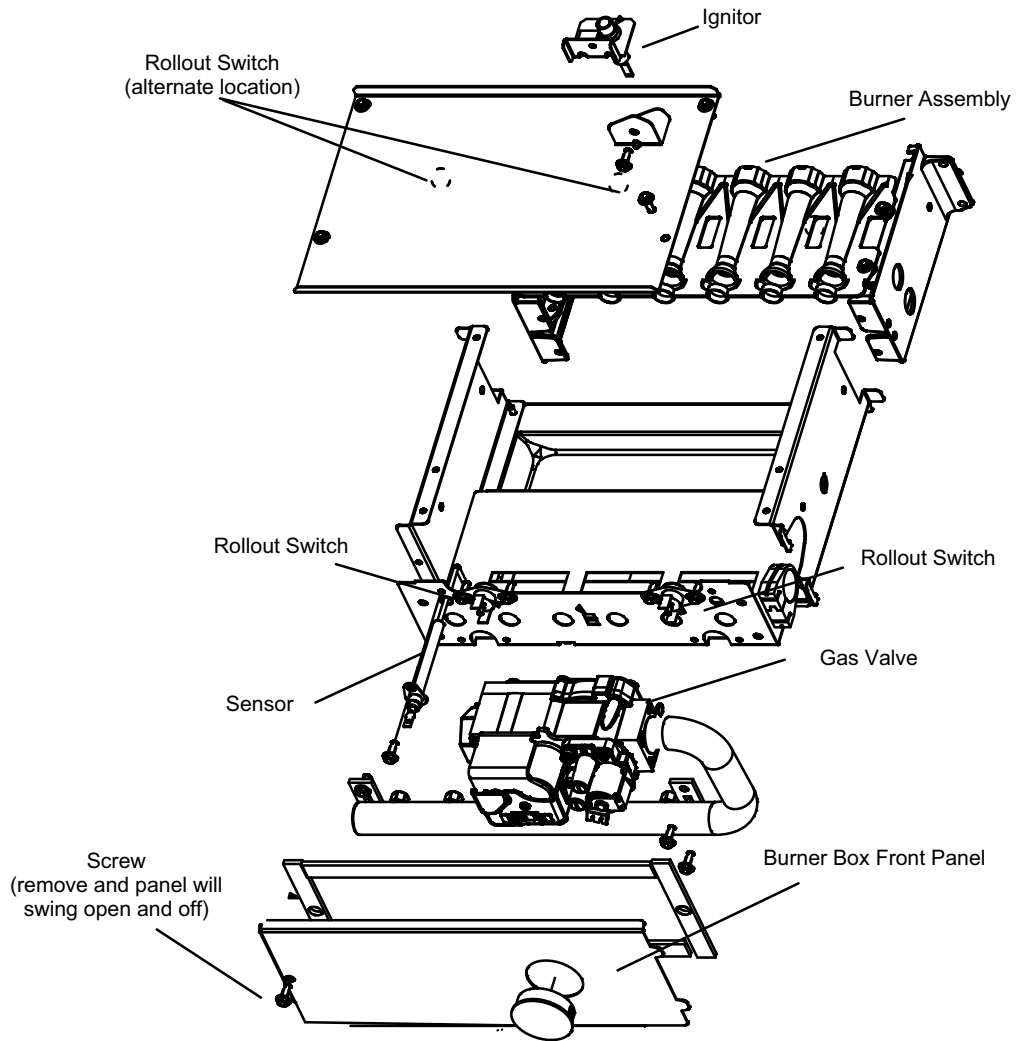
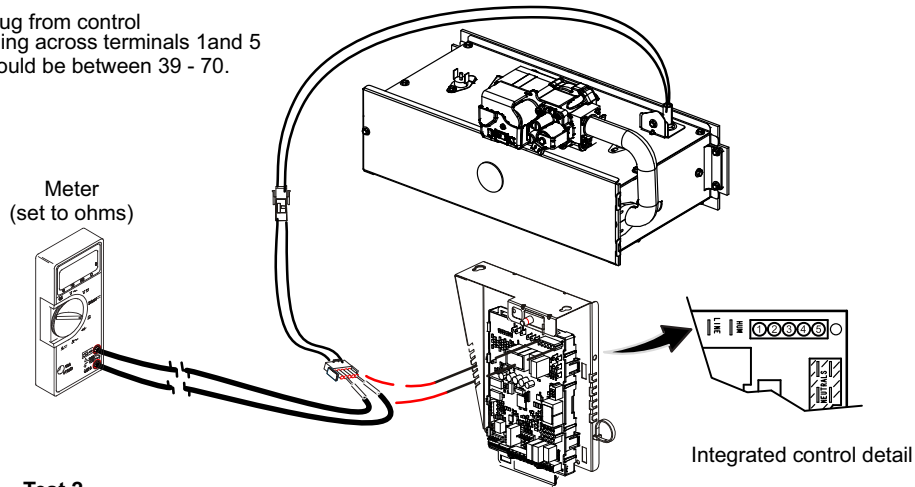

FIGURE 13

SL280UH Ignitor Check Out

Test 1

Remove 5-pin plug from control
Check ohms reading across terminals 1 and 5
Ohm value should be between 39 - 70.



Test 2

Separate the 2-pin jack plug near the manifold and check resistance of the ignitor. If the reading is correct, then there is a problem with the wiring between the jack plug and control. If the reading is not correct the issue is the ignitor.

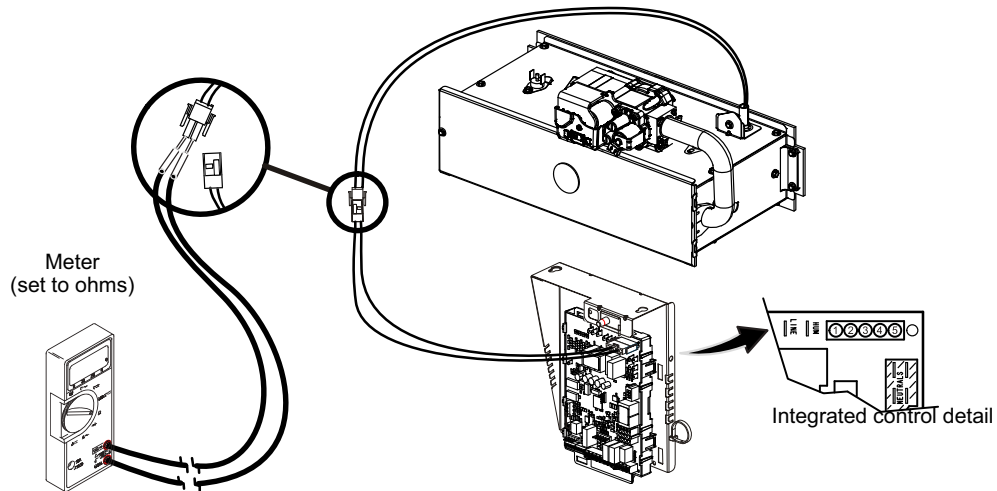

Test 3

Insert meter probes into the terminals 1 and 5. (Use small diameter probes in order to not damage plug). Check voltage during 20 second warm up period. Voltage should read 120 volts \pm 10%. If voltage is above these values, check for correct supply voltage to furnace.

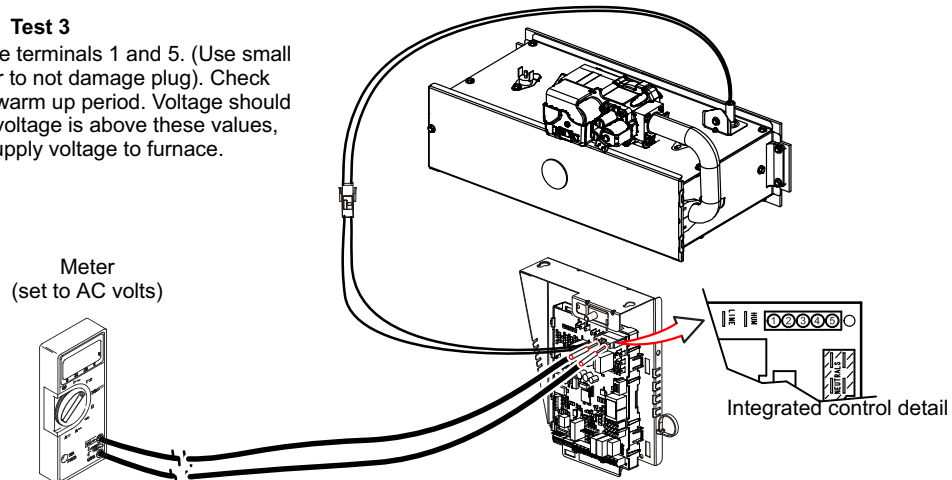

FIGURE 14

8. Combustion Air Inducer (B6)

All SL280UHV(X) units use a two-stage combustion air inducer to move air through the burners and heat exchanger during heating operation. The blower uses a 120VAC motor. The motor operates during all heating operation and is controlled by integrated control control A92. The inducer also operates for 15 seconds before burner ignition (pre-purge) and for 5 seconds after the gas valve closes (post-purge). The inducer operates on low speed during first-stage heat, then switches to high speed for second stage heat.

NOTE - Each furnace model uses a unique CAI. Refer to Lennox Repair Parts listing for correct inducer for replacement.

A proving switch connected to the combustion air inducer orifice plate is used to prove inducer operation. The combustion air inducer orifice will be different for each model. See table 15 for orifice sizes. The switch monitors air pressure in the inducer housing. During normal operation, the pressure in the housing is negative. If pressure becomes less negative (signifying an obstruction) the proving switch opens. When the proving switch opens, the furnace control (A92) immediately closes the gas valve to prevent burner operation.

TABLE 15

SL280UHV(X) Unit	C.A.I. Orifice Size
-070	1.344
-090	1.531
-110	1.812
-135	1.875

9. Combustion Air Inducer Prove Switch (S18)

SL280UHV(X) series units are equipped with a dual combustion air proving switch (first and second stage) located on the combustion air inducer orifice bracket. See figure 15. The switch is connected to the combustion air inducer housing by means of a flexible silicone hose. It monitors negative air pressure in the combustion air inducer housing.

The switches are a single-pole single-throw proving switch electrically connected to the integrated control. The purpose of the switch is to prevent burner operation if the combustion air inducer is not operating or if the flue becomes obstructed.

On heat demand (first or second stage) the switch senses that the combustion air inducer is operating. It closes a circuit to the integrated control when pressure inside the combustion air inducer decreases to a certain set point.

Set points vary depending on unit size. See table 16. The pressure sensed by the switch is negative relative to atmospheric pressure. If the flue becomes obstructed during operation, the switch senses a loss of negative pressure (pressure becomes more equal with atmospheric pressure) and opens the circuit to the furnace control and gas valve. A bleed port on the switch allows relatively dry air in the vestibule to purge switch tubing, to prevent condensate build up.

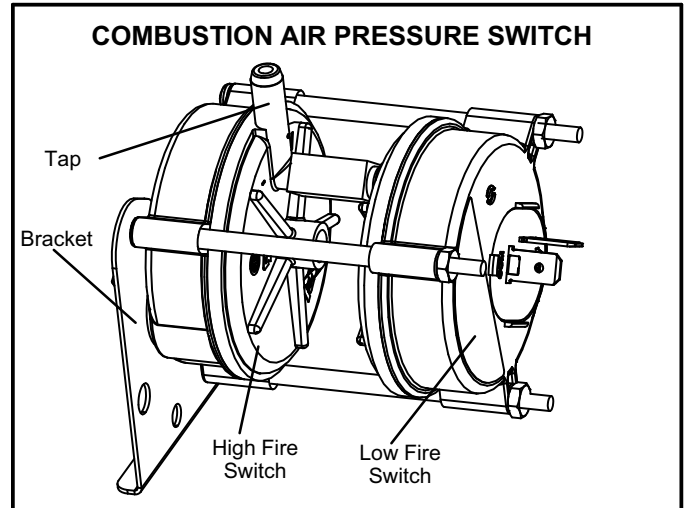

FIGURE 15

NOTE - The switch is factory set and is not field adjustable. It is a safety shut-down control in the furnace and must not be by-passed for any reason. If switch is closed or by-passed, the control will not initiate ignition at start up.

TABLE 16

SL280UHV(X) Unit	Set Point Low Heat	Set Point High Heat
-070V36A-01 and later	0.25	0.60
-090V36B -090V60C -01 and later	0.30	0.68
-090V48B-01, -02, -03	0.30	0.68
-090V48B-04 and later	0.35	0.68
-110V60C-01 and later	0.30	0.68
-135V60D-01 and later	0.35	0.75

Multiple Venting

The SL280UHV(X) furnace can vent in multiple positions. See figure 16.

The make up box may be removed and the combustion air inducer may be rotated clockwise or counterclockwise 90° to allow for vertical or horizontal vent discharge in a vertical or horizontal cabinet position. Remove the four mounting

screws, rotate the assembly (assembly consists of orifice plate, proving switch, gasket and combustion air inducer), then reinstall the mounting screws. See unit Installation Instructions for more detail.

▲ IMPORTANT

The combustion air pressure switch must be moved for horizontal discharge air left position.

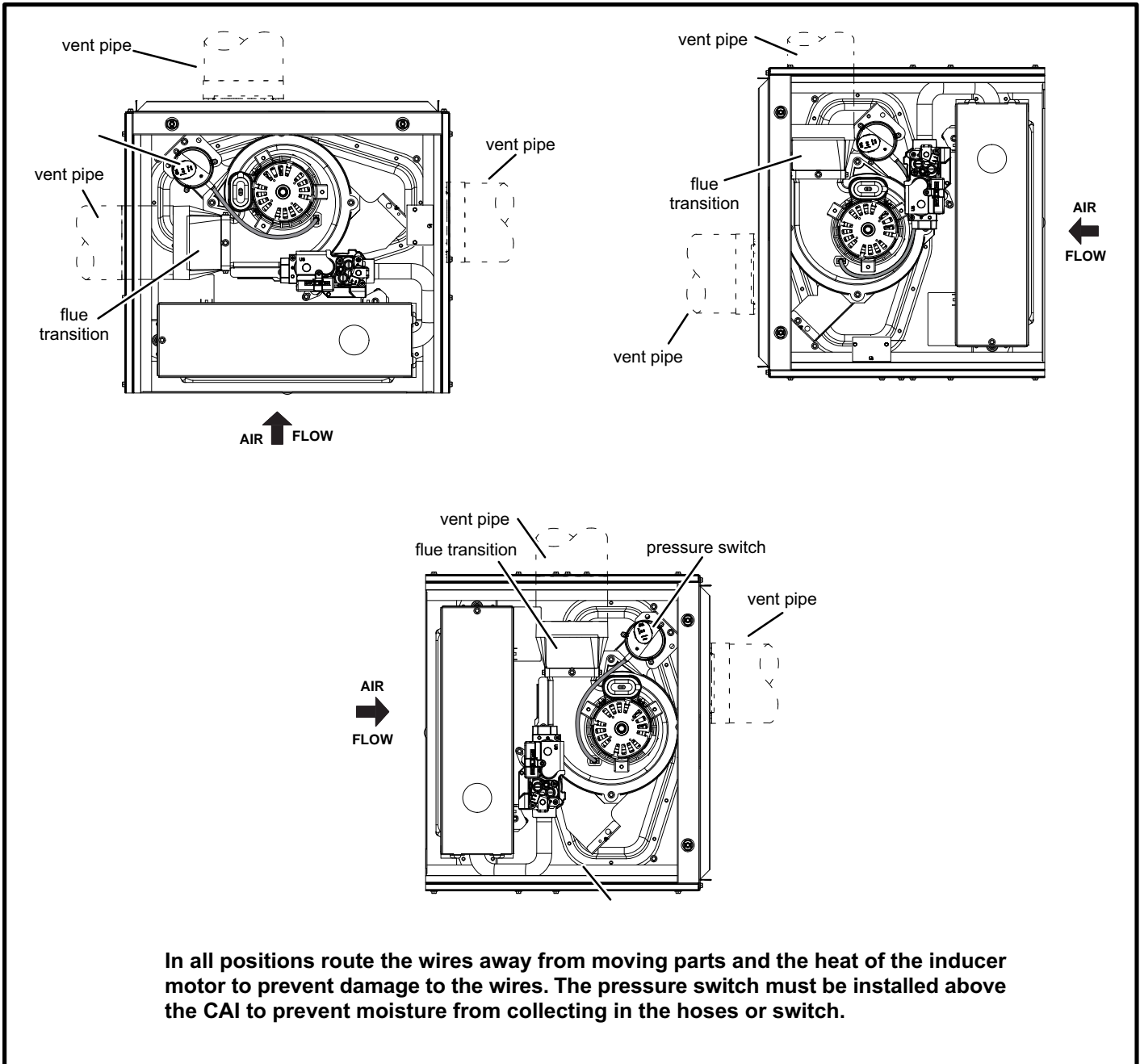

FIGURE 16

II-PLACEMENT AND INSTALLATION

Make sure unit is installed in accordance with installation instructions and applicable codes.

III-START-UP

A-Preliminary and Seasonal Checks

- 1 - Inspect electrical wiring, both field and factory installed for loose connections. Tighten as required.
- 2 - Check voltage at disconnect switch. Voltage must be within range listed on the nameplate. If not, consult the power company and have voltage condition corrected before starting unit.

B-Heating Start-Up

⚠ WARNING

Shock and burn hazard.

SL280UHV(X) units are equipped with a hot surface ignition system. Do not attempt to light manually.

- 1 - **STOP!** Read the safety information at the beginning of this section.
- 2 - Set the thermostat to the lowest setting.
- 3 - Turn off all electrical power to the unit.
- 4 - This furnace is equipped with an ignition device which automatically lights the burners. Do **not** try to light the burners by hand.
- 5 - Remove the access panel.
- 6 - Turn switch on gas valve to **OFF**. Do not force. See figure 17 or 18.
- 7 - Wait five minutes to clear out any gas. If you then smell gas, **STOP!** Immediately call your gas supplier from a neighbor's phone. Follow the gas supplier's instructions. If you do not smell gas go to next step.

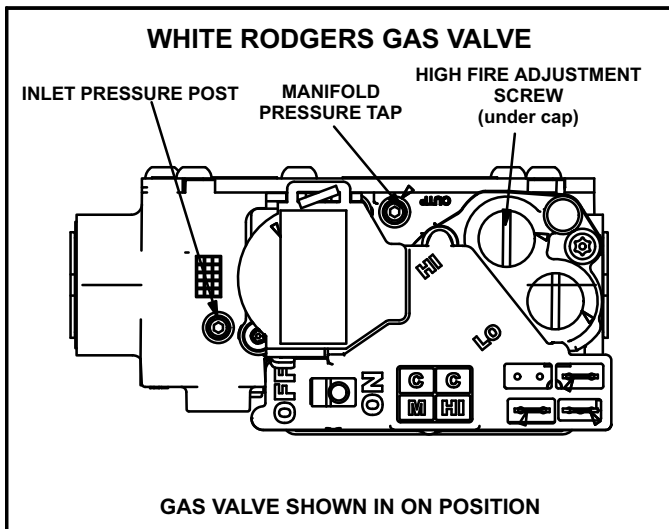

FIGURE 17

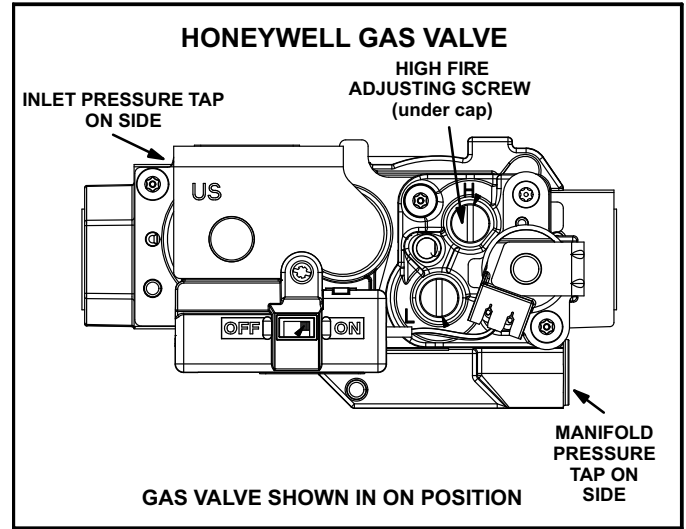

FIGURE 18

- 8 - Move switch on gas valve to **ON**. Do not force. See figure 17 or 18.
- 9 - Replace the access panel.
- 10 - Turn on all electrical power to the unit.
- 11 - Set the thermostat to desired setting.

NOTE - When unit is initially started, steps 1 through 11 may need to be repeated to purge air from gas line.

Turning Off Gas To Unit

- 1 - Set thermostat to lowest setting.
- 2 - Turn off all electrical power to unit if service is to be performed.
- 3 - Remove access panel.
- 4 - Move switch on valve to **OFF**. Do not force.
- 5 - Replace access panel.

Failure To Operate

If the unit fails to operate, check the following:

- 1 - Is the thermostat calling for heat?
- 2 - Are access panels securely in place?
- 3 - Is the main disconnect switch closed?
- 4 - Is there a blown fuse or tripped circuit breaker?
- 5 - Is the filter dirty or plugged? Dirty or plugged filters will cause the limit control to shut the unit off.
- 6 - Is gas turned on at the meter?
- 7 - Is the manual main shut-off valve open?
- 8 - Is the internal manual shut-off valve open?
- 9 - Is the unit ignition system in lock out? If the unit locks out again, call the service technician to inspect the unit for blockages.
- 10 - Is pressure switch closed? Obstructed flue will cause unit to shut off at pressure switch. Check flue and outlet for blockages.
- 11 - Are flame rollout switches tripped? If flame rollout switches are tripped, call the service technician for inspection.

C-Safety or Emergency Shutdown

Turn off unit power. Close manual and main gas valves.

D-Extended Period Shutdown

Turn off thermostat or set to "UNOCCUPIED" mode. Close all gas valves (both internal and external to unit) to guarantee no gas leak into combustion chamber. Turn off power to unit. All access panels and covers must be in place and secured.

IV-HEATING SYSTEM SERVICE CHECKS

A-CSA Certification

All units are CSA design certified without modifications. Refer to the SL280UHV(X) Installation Instruction.

B-Gas Piping

⚠ CAUTION

If a flexible gas connector is required or allowed by the authority that has jurisdiction, black iron pipe shall be installed at the gas valve and extend outside the furnace cabinet.

⚠ WARNING

Do not over torque (800 in-lbs) or under torque (350 in-lbs) when attaching the gas piping to the gas valve.

Gas supply piping should not allow more than 0.5"W.C. drop in pressure between gas meter and unit. Supply gas pipe must not be smaller than unit gas connection.

Compounds used on gas piping threaded joints should be resistant to action of liquefied petroleum gases.

C-Testing Gas Piping

⚠ IMPORTANT

In case emergency shutdown is required, turn off the main shut-off valve and disconnect the main power to unit. These controls should be properly labeled by the installer.

When pressure testing gas lines, the gas valve must be disconnected and isolated. Gas valves can be damaged if subjected to more than 0.5 psig (14" W.C.). See figure 19. If the pressure is greater than 0.5psig (14"W.C.), use the manual shut-off valve before pressure testing to isolate furnace from gas supply.

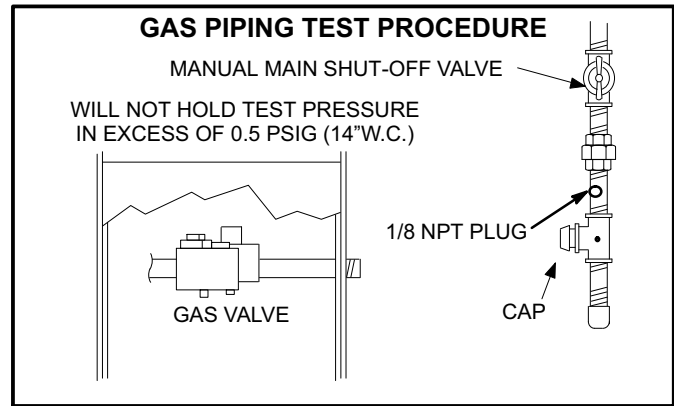

FIGURE 19

When checking piping connections for gas leaks, use preferred means. Kitchen detergents can cause harmful corrosion on various metals used in gas piping. Use of a specialty Gas Leak Detector is strongly recommended. It is available through Lennox under part number 31B2001. See Corp. 8411-L10, for further details.

Do not use matches, candles, flame or any other source of ignition to check for gas leaks.

D-Testing Gas Supply Pressure

White Rodgers Gas Valve

An inlet post located on the gas valve provides access to the supply pressure. See figure 17. Back out the 3/32 hex screw one turn, connect a piece of 5/16 tubing and connect to a manometer to measure supply pressure. See table 19 for supply line pressure.

Honeywell Gas Valve

A threaded plug on the inlet side of the gas valve provides access to the supply pressure tap. Remove the threaded plug, install a field-provided barbed fitting and connect a manometer to measure supply pressure. See table 19 for supply line pressure. Replace the threaded plug after measurements have been taken.

E-Check Manifold Pressure

After line pressure has been checked and adjusted, check manifold pressure. Move pressure gauge to outlet pressure tap located on unit gas valve (GV1). Checks of manifold pressure are made as verification of proper regulator adjustment. Manifold pressure for the SL280UHV(X) can be measured at any time the gas valve is open and is supplying gas to the unit. See table 19 for operating manifold pressure.

⚠ IMPORTANT

For safety, connect a shut-off valve between the manometer and the gas tap to permit shut off of gas pressure to the manometer.

The gas valve is factory set and should not require adjustment. All gas valves are factory regulated.

Manifold Adjustment Procedure:

NOTE - Pressure test adapter kit (10L34) is available from Lennox to facilitate manifold pressure measurement.

- 1 - Connect test gauge to manifold pressure post (figure 17) or tap (figure 18) on gas valve.

- 2 - Ignite unit on **low fire** and let run for 5 minutes to allow for steady state conditions.
- 3 - After allowing unit to stabilize for 5 minutes, record manifold pressure and compare to value given in table 19.
- 4 - If necessary, make adjustments. Figures 17 and 18 show location of high fire and low fire adjustment screw.
- 5 - Repeat steps 2, 3 and 4 on high fire.
- 6 - Shut unit off and remove manometer as soon as an accurate reading has been obtained. Take care to replace pressure tap plug.
- 7 - Start unit and perform leak check. Seal leaks if found.

F- Proper Gas Flow (Approximate)

Furnace should operate at least 5 minutes before checking gas flow. Determine time in seconds for **two** revolutions of gas through the meter. (Two revolutions assures a more accurate time.) **Divide by two** and compare to time in table 17 below. If manifold pressure matches table 19 and rate is incorrect, check gas orifices for proper size and restriction.

NOTE- To obtain accurate reading, shut off all other gas appliances connected to meter.

TABLE 17

GAS METER CLOCKING CHART				
SL280 Unit	Seconds for One Revolution			
	Natural		LP	
	1 cu ft Dial	2 cu ft Dial	1 cu ft Dial	2 cu ft DIAL
-045	80	160	200	400
-70	55	110	136	272
-90	41	82	102	204
-110	33	66	82	164
-135	27	54	68	136
Natural-1000 btu/cu ft			LP-2500 btu/cu ft	

⚠ IMPORTANT

For safety, shut unit off and remove manometer as soon as an accurate reading has been obtained. Take care to replace pressure tap plug.

G- Proper Combustion

Furnace should operate minimum 15 minutes with correct manifold pressure and gas flow rate before checking combustion. See sections E- and F-. Take combustion sample beyond the flue outlet. Table 18 shows acceptable combustion for ALL SL280UHV models. The maximum carbon monoxide reading should not exceed 100 ppm.

TABLE 18

Firing Rate	CO₂% For Nat	CO₂% For L.P.
High Fire	6.8 - 7.4	7.5 - 9.0
Low Fire	4.2 - 5.7	5.0 - 6.0

H- High Altitude

The manifold pressure, gas orifice and pressure switch may require adjustment or replacement to ensure proper operation at higher altitudes. See table 19 for manifold pressures and tables 20, 21, and 22 for pressure switch and gas conversion kits.

TABLE 19
Manifold Pressure Settings

Unit Input	Gas	Orifice Size 0 - 7500 ft. ¹	Orifice Size 7501 - 10,000 ft.	Manifold Pressure in.wg. 0-4500 ft.		Manifold Pressure in.wg. 4501-7500 ft.		Manifold Pressure in.wg. 7501 - 10,000 ft. ²		Supply Line Pressure in. w.g.	
				Low Fire	High Fire	Low Fire	High Fire	Low Fire	High Fire	Min	Max
070	Natural	.063	.055	1.7	3.5	1.6	3.4	1.7	3.5	4.5	13.0
	LP/propane ³	.034	.032	4.5	10.0	4.5	10.0	4.5	10.0	11.0	13.0
090	Natural	.063	.055	1.7	3.5	1.5	3.2	1.7	3.5	4.5	13.0
	LP/propane ³	.034	.032	4.5	10.0	4.5	10.0	4.5	10.0	11.0	13.0
110	Natural	.063	.055	1.7	3.5	1.5	3.2	1.7	3.5	4.5	13.0
	LP/propane ³	.034	.032	4.5	10.0	4.5	10.0	4.5	10.0	11.0	13.0
135	Natural	.063	.055	1.7	3.5	1.6	2.8	1.7	3.5	4.5	13.0
	LP/propane ³	.034	.032	4.5	10.0	4.5	10.0	4.5	10.0	11.0	13.0

¹ This is the only permissible derate for these units.

² Natural gas high altitude orifice kit required.

³ A natural to L.P. propane gas changeover kit is necessary to convert this unit. Refer to the changeover kit installation instruction for the conversion procedure.

NOTE - Units may be installed at altitudes up to 4500 ft. above sea level without modifications.

TABLE 20
High Altitude Pressure Switch Kits

Unit Input	High Altitude Pressure Switch Kit		
	0 - 4500 ft.	4501 - 7500 ft.	7501 - 10,000 ft.
070	No Change	No Change	73W35
090	No Change	69W56	73W35
110	No Change	69W56	73W35
135	No Change	73W33	73W34

TABLE 21
Honeywell Gas Valve Conversion Kits

Unit Input	High Altitude Natural Gas Orifice Kit	Natural Gas to LP/ Propane Kit		LP/Propane to Natural Gas Kit
	7501 - 10,000 ft.	0 - 7500 ft.	7501 - 10,000 ft.	0 - 7500 ft.
070	73W37	51W02	73W38	69W79
090	73W37	51W02	73W38	69W79
110	73W37	51W02	73W38	69W79
135	73W37	51W02	73W38	69W79

TABLE 22
White Rodgers Gas Valve Conversion Kits

Unit Input	High Altitude Natural Gas Orifice Kit	Natural Gas to LP/ Propane Kit		LP/Propane to Natural Gas Kit
	7501 - 10,000 ft.	0 - 7500 ft.	7501 - 10,000 ft.	0 - 7500 ft.
070	73W37	11K51	11K46	77W09
090				
110				
135				

V-TYPICAL OPERATING CHARACTERISTICS

A-Blower Operation and Adjustment

- 1 - Blower operation is dependent on thermostat control system.
- 2 - Generally, blower operation is set at thermostat sub-base fan switch. With fan switch in ON position, blower operates continuously. With fan switch in AUTO position, blower cycles with demand or runs continuously while heating or cooling circuit cycles.
- 3 - Depending on the type of indoor thermostat, blower and entire unit will be off when the system switch is in OFF position.

B-Temperature Rise (Figure 20)

Temperature rise for SL280UHV units depends on unit input, blower speed, blower horsepower and static pressure as marked on the unit rating plate. The blower speed must be set for unit operation within the range of "TEMP. RISE °F" listed on the unit rating plate.

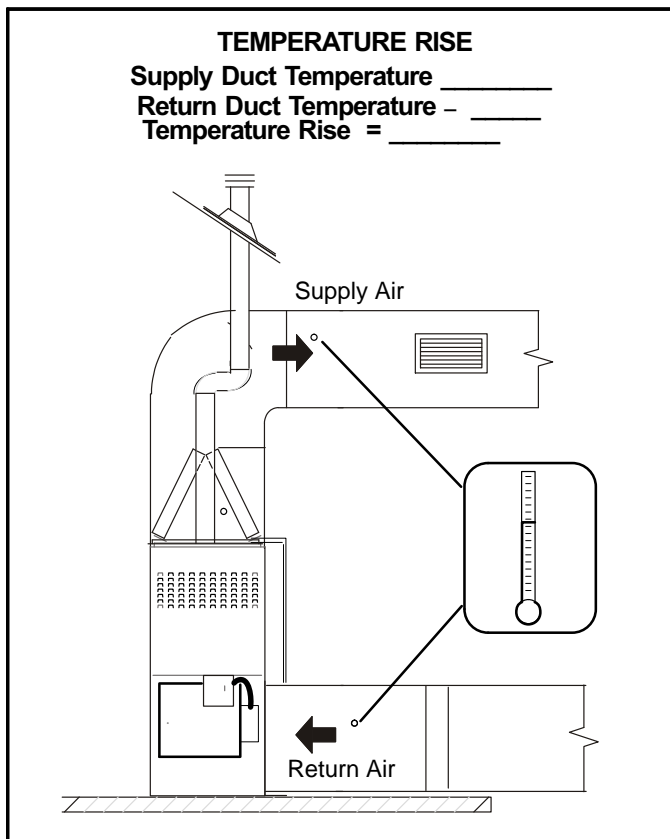

FIGURE 20

C-External Static Pressure

- 1 - Tap locations shown in figure 21.
- 2 - Punch a 1/4" diameter hole in supply and return air plenums. Insert manometer hose flush with inside edge of hole or insulation. Seal around the hose with permagum. Connect the zero end of the manometer to the discharge (supply) side of the system. On ducted systems, connect the other end of manometer to the return duct as above.
- 3 - With only the blower motor running and the evaporator coil dry, observe the manometer reading. Adjust blower motor speed to deliver the air desired according to the job requirements. For heating speed external static pressure drop must not be more than 0.5" W.C. For cooling speed external static pressure drop must not be more than 0.8" W.C.
- 4 - Seal the hole when the check is complete.

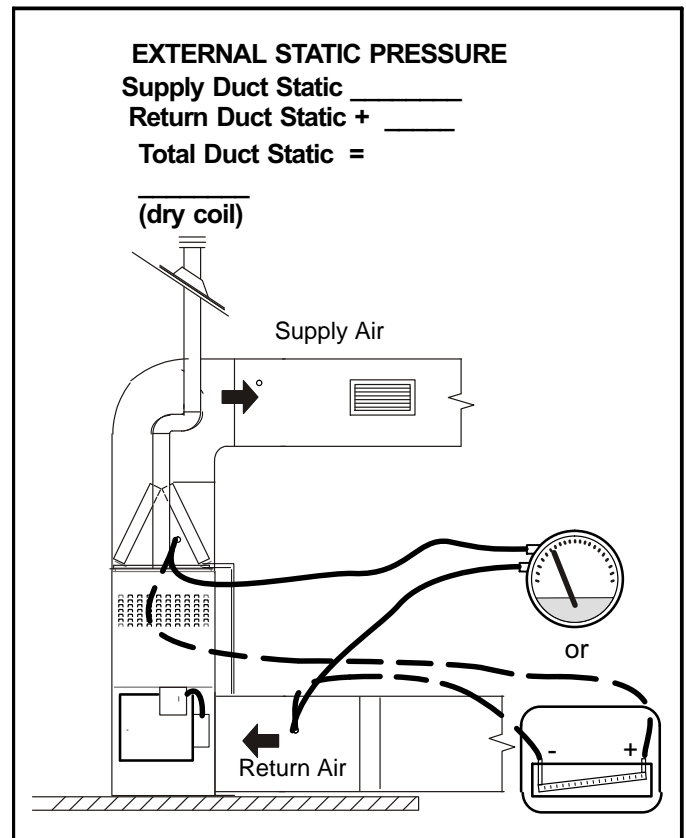

FIGURE 21

VI-MAINTENANCE

Annual Furnace Maintenance

At the beginning of each heating season, and to comply with the **Lennox Limited Warranty**, your system should be checked by a licensed professional technician (or equivalent) as follows:

⚠ WARNING

Disconnect power before servicing unit.

⚠ CAUTION

Label all wires prior to disconnection when servicing controls. Wiring errors can cause improper and dangerous operation. Verify proper operation after servicing.

- 1- Check wiring for loose connections, voltage at indoor unit and amperage of indoor motor.
- 2- Check the condition of the belt and shaft bearings if applicable.
- 3- Inspect all gas pipe and connections for leaks.
- 4- Check the cleanliness of filters and change if necessary (monthly).

⚠ IMPORTANT

If a high-efficiency filter is being installed as part of this system to ensure better indoor air quality, the filter must be properly sized. High-efficiency filters have a higher static pressure drop than standard-efficiency glass/foam filters. If the pressure drop is too great, system capacity and performance may be reduced. The pressure drop may also cause the limit to trip more frequently during the winter and the indoor coil to freeze in the summer, resulting in an increase in the number of service calls.

Before using any filter with this system, check the specifications provided by the filter manufacturer against the data given in the appropriate Lennox Product Specifications bulletin. Additional information is provided in Service and Application Note ACC-00-2 (August 2000).

⚠ WARNING

The blower access panel must be securely in place when the blower and burners are operating. Gas fumes, which could contain carbon monoxide, can be drawn into living space resulting in personal injury or death.

- 5- Check the condition and cleanliness of burners and heat exchanger and clean if necessary.
- 6- Check the cleanliness of blower assembly and clean the housing, blower wheel and blower motor if neces-

sary. The blower motors are prelubricated for extended bearing life. No further lubrication is needed.

- 7- Inspect the combustion air inducer and clean if necessary.
- 8- Evaluate the heat exchanger integrity by inspecting the heat exchanger per the AHRI heat exchanger inspection procedure. This procedure can be viewed at www.ahrinet.org
- 9- Ensure sufficient combustion air is available to the furnace. Fresh air grilles and louvers (on the unit and in the room where the furnace is installed) must be properly sized, open and unobstructed to provide combustion air.
- 10 Inspect the furnace venting system to make sure it is in place, structurally sound, and without holes, corrosion, or blockage. Vent system must be free and clear of obstructions and must slope upward away from the furnace. Vent system should be installed per the National Fuel Gas Code
- 11 Inspect the furnace return air duct connection to ensure the duct is sealed to the furnace. Check for air leaks on supply and return ducts and seal where necessary.
- 12 Check the condition of the furnace cabinet insulation and repair if necessary.
- 13 Perform a complete combustion analysis during the furnace inspection to ensure proper combustion and operation. Consult Service Literature for proper combustion values.
- 14 Verify operation of CO detectors and replace batteries as required.

Perform a general system test. Turn on the furnace to check operating functions such as the start-up and shut-off operation.

- 1 - Check the operation of the ignition system, inspect and clean flame sensor. Check microamps before and after. Check controls and safety devices (gas valve, flame sensor, temperature limits). Consult Service Manual for proper operating range. Thermal Limits should be checked by restricting airflow and not disconnecting the indoor blower. For additional details, please see Service and Application Note H-04-9.
- 2 - Verify that system total static pressure and airflow settings are within specific operating parameters.
- 3 - Clock gas meter to ensure that the unit is operating at the specified firing rate. Check the supply pressure and the manifold pressure. On two-stage gas furnaces check the manifold pressure on high fire and low fire. If manifold pressure adjustment is necessary, consult the Service Literature for unit specific information on adjusting gas pressure. Not all gas valves are adjustable. Verify correct temperature rise.

A-Heat Exchanger and Burners

Cleaning the Heat Exchanger and Burners

NOTE - Use papers or protective covering in front of the furnace during cleaning.

- 1 - Turn off both electrical and gas power supplies to furnace.
- 2 - Remove flue pipe and top cap (*some applications top cap can remain*) from the unit.
- 3 - Label the wires from gas valve, rollout switches, primary limit switch and make-up box then disconnect them.
- 4 - Remove the screws that secure the combustion air inducer/pressure switch assembly to the collector box. Carefully remove the combustion air inducer to avoid damaging blower gasket. If gasket is damaged, it must be replaced to prevent leakage.
- 5 - Remove the collector box located behind the combustion air inducer. Be careful with the collector box gasket. If the gasket is damaged, it must be replaced to prevent leakage.
- 6 - Disconnect gas supply piping. Remove the screw securing the burner box cover and remove cover. Remove the four screws securing the burner manifold assembly to the vestibule panel and remove the assembly from the unit.
- 7 - Remove screws securing burner box and remove burner box.
- 8 - **NOX units only** - Remove screw securing NOX insert. Remove NOX insert. See figure 23.
- 9 - Remove screws from both sides, top and bottom of vestibule panel.
- 10 - Remove heat exchanger. It may be necessary to spread cabinet side to allow more room. If so, remove five screws from the left side or right side of cabinet. See figure 24.
- 11 - Back wash using steam. Begin from the burner opening on each clam. Steam must not exceed 275°F.
- 12 - To clean burners, run a vacuum cleaner with a soft brush attachment over the face of burners. Visually inspect inside the burners and crossovers for any blockage caused by foreign matter. Remove any blockage. Figure 22 shows burner detail.
- 13 - To clean the combustion air inducer visually inspect and using a wire brush clean where necessary. Use compressed air to clean off debris and any rust.
- 14 - Reinstall heat exchanger in vestibule. (Replace the five screws in the cabinet from step 10 if removed).
- 15 - **NOX units only** - replace NOX insert.
- 16 - Reinstall collector box and combustion air assembly. Reinstall all screws to the collector box and combustion air inducer. Failure to replace all screws may cause leaks. Inspect gaskets for any damage and replace if necessary.
- 17 - Reinstall burner box, manifold assembly and burner box cover.
- 18 - Reconnect all wires.
- 19 - Reconnect top cap and vent pipe to combustion air inducer outlet.
- 20 - Reconnect gas supply piping.
- 21 - Turn on power and gas supply to unit.
- 22 - Set thermostat and check for proper operation.
- 23 - Check all piping connections, factory and field, for gas leaks. Use a leak detecting solution or other preferred means.
- 24 - If a leak is detected, shut gas and electricity off and repair leak.
- 25 - Repeat steps 24 and 26 until no leaks are detected.
- 26 - Replace access panel.

CAUTION

Some soaps used for leak detection are corrosive to certain metals. Carefully rinse piping thoroughly after leak test has been completed. Do not use matches, candles, flame or other sources of ignition to check for gas leaks.

**SL280UHV BURNER, C.A.I ASSEMBLY &
HEAT EXCHANGER REMOVAL**

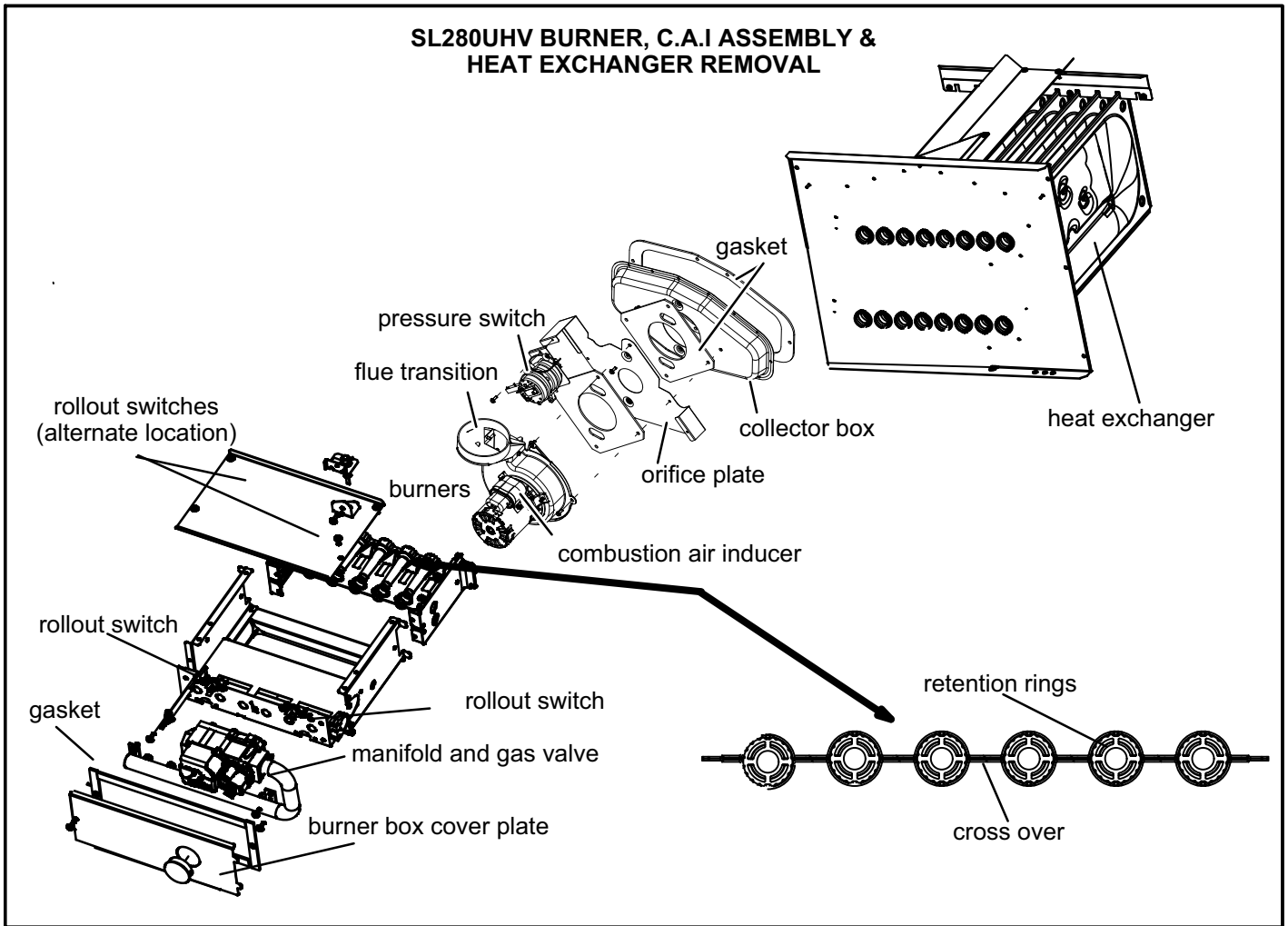

FIGURE 22

SL280UHV NOX INSERTS

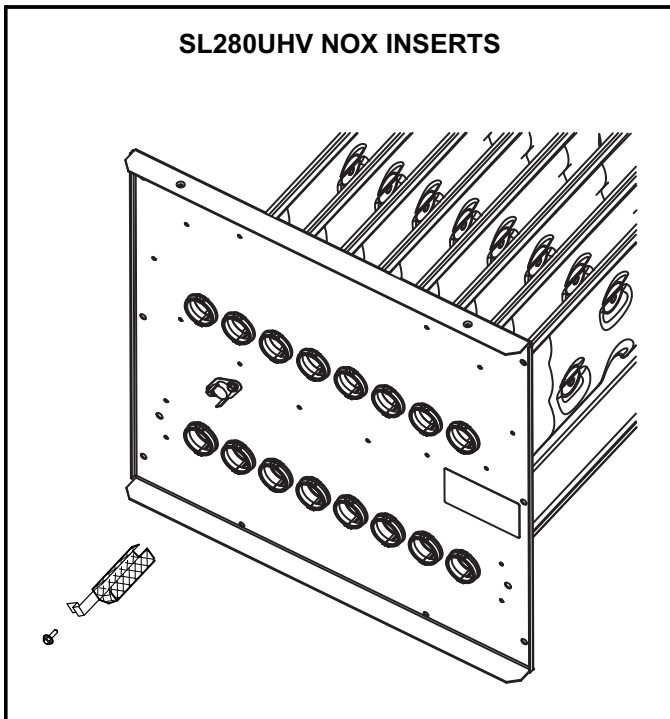

FIGURE 23

**Remove 5 screws if necessary
(either side of cabinet)**

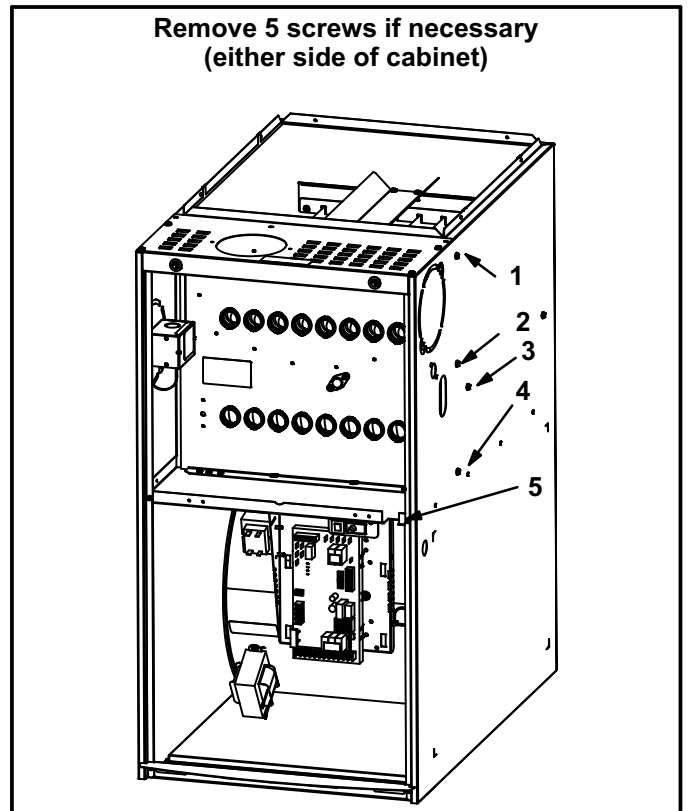
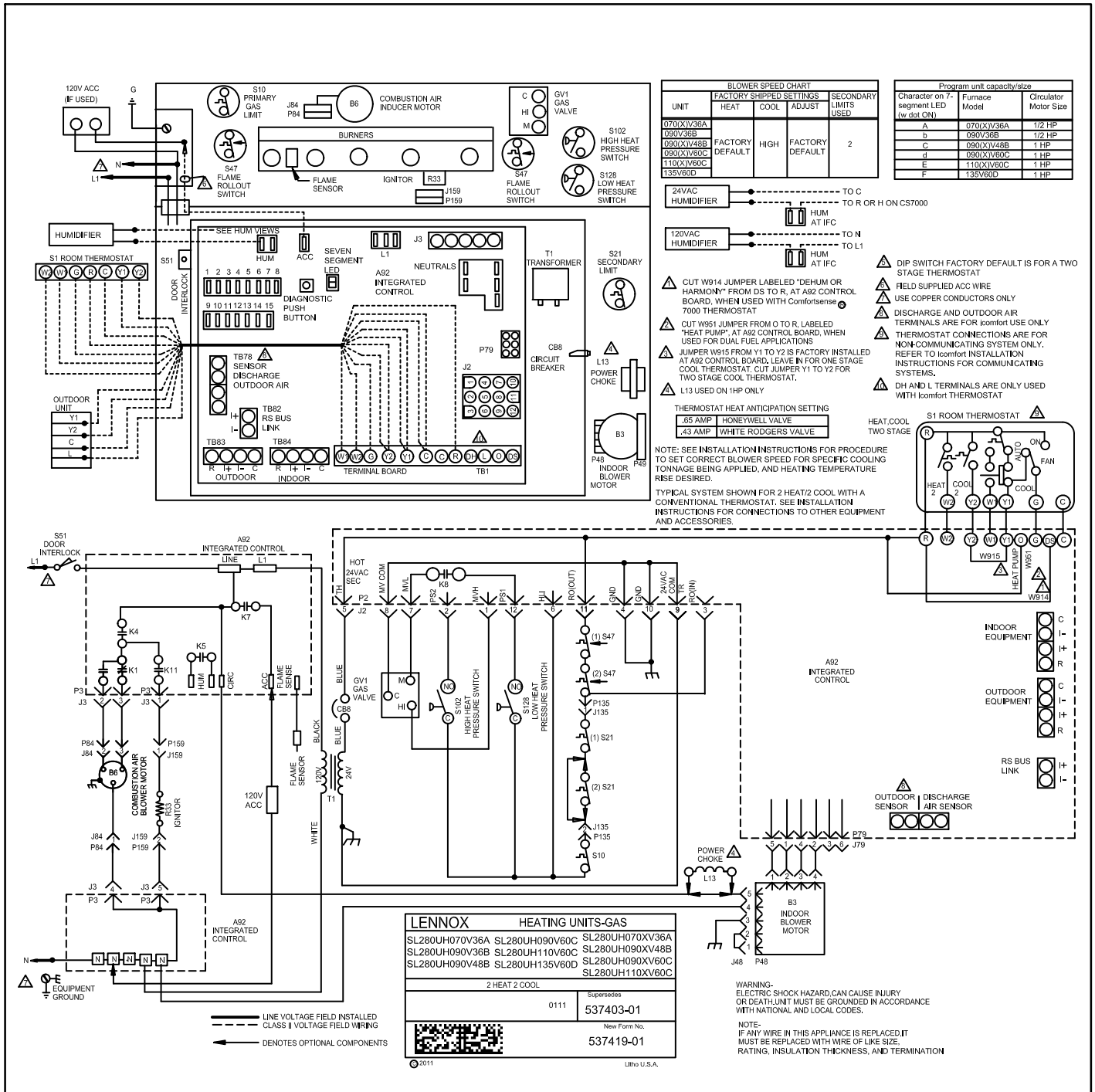

FIGURE 24

VII- Wiring and Sequence of Operation



Integrated Control Self Check

When there is a call for heat, the icomfort™ enabled integrated control runs a self check. The control checks for S10 primary limit, S21 secondary limit (s) and S47 rollout switch normally closed contacts. The control also checks for S102 high heat and S128 low heat prove switch normally open contacts. Once self check is complete and all safety switches are operational, heat call can continue.

NOTE - The ignition control thermostat selection DIP switch is factory-set in the "TWO-STAGE" position.

⚠ WARNING

Electric Shock Hazard. Can cause injury or death. Unit must be properly grounded in accordance with national and local codes.

⚠ WARNING

Fire Hazard. Use of aluminum wire with this product may result in a fire, causing property damage, severe injury or death. Use copper wire only with this product.

CAUTION

Failure to use properly sized wiring and circuit breaker may result in property damage. Size wiring and circuit breaker(s) per Product Specifications bulletin (EHB) and unit rating plate.

Applications Using a Two-Stage Thermostat

A - Heating Sequence -- Integrated Control Thermostat Selection DIP Switch 1 OFF in "Two-Stage" Position (Factory Setting)

1. On a call for heat, thermostat first-stage contacts close sending a signal to the integrated control. The integrated control runs a self-diagnostic program and checks high temperature limit switches for normally closed contacts and pressure switches for normally open contacts. The combustion air inducer is energized at low speed.
2. Once the control receives a signal that the low pressure switch has closed, the combustion air inducer begins a 15-second pre-purge in low speed.
NOTE - If the low fire pressure switch does not close the combustion air inducer will switch to high fire. After a 15 second pre-purge the high fire pressure switch will close and the unit will begin operation on high fire. After 10 to 20 seconds of high fire operation the unit will switch to low fire..
3. After the pre-purge is complete, a 20-second initial ignitor warm-up period begins. The combustion air inducer continues to operate at low speed.
- 4 - After the 20-second warm-up period has ended, the gas valve is energized on low fire (first stage) and ignition occurs. At the same time, the control module sends a signal to begin an indoor blower 30-second ON-delay. When the delay ends, the indoor blower motor is energized on the low fire heating speed, the HUM contacts close energizing the humidifier and 120V ACC terminal is energized. The furnace will continue this operation as long as the thermostat has a first-stage heating demand.
NOTE - If the indoor thermostat is set on CONTINUOUS FAN ON mode, the furnace will light on high fire (second-stage) for 60 seconds to improve heat exchanger warm up. After 60 second warm-up period, furnace will switch to low fire (first-stage).
- 5 - If second-stage heat is required, the thermostat second-stage heat contacts close and send a signal to the integrated control. The integrated control initiates a 30-second second-stage recognition delay.
- 6 - At the end of the recognition delay, the integrated control energizes the combustion air inducer at high speed. The control also checks the high fire (second stage) pressure switch to make sure it is closed. The high fire (second stage) gas valve is energized and the indoor blower motor is energized for operation at the high fire heating speed.
- 7 - When the demand for high fire (second stage) heat is satisfied, the combustion air inducer is switched to the low-fire heating speed and the high-fire (second stage) gas valve is de-energized. The low-fire (first stage) gas valve continues operation. The indoor blower motor is switched to the low-fire heating speed.

- 8 - When the thermostat demand for low-fire (first stage) heat is satisfied, the gas valve is de-energized and the field-selected indoor blower off delay begins. The combustion air inducer begins a 5-second post-purge period.
- 9 - When the combustion air post-purge period is complete, the inducer, the HUM contacts as well as the 120V ACC terminals are de-energized. The indoor blower is de-energized at the end of the off delay.

Applications Using A Single-Stage Thermostat

B - Heating Sequence -- Integrated Control Thermostat Selection DIP Switch 1 ON in "Single-Stage" Position

NOTE - In these applications, two-stage heat will be initiated by the integrated control if heating demand has not been satisfied after the field adjustable period (7 or 12 minutes).

1. On a call for heat, thermostat first-stage contacts close sending a signal to the integrated control. The integrated control runs a self-diagnostic program and checks high temperature limit switches for normally closed contacts and pressure switches for normally open contacts. The combustion air inducer is energized at low speed.
2. Once the control receives a signal that the low pressure switch has closed, the combustion air inducer begins a 15-second pre-purge in low speed.
NOTE - If the low fire pressure switch does not close the combustion air inducer will switch to high fire. After a 15 second pre-purge the high fire pressure switch will close and the unit will begin operation on high fire. After 10 to 20 seconds of high fire operation the unit will switch to low fire.
3. After the pre-purge is complete, a 20-second initial ignitor warm-up period begins. The combustion air inducer continues to operate at low speed.
- 4 - After the 20-second warm-up period has ended, the gas valve is energized on low fire (first stage) and ignition occurs. At the same time, the control module sends a signal to begin an indoor blower 30-second ON-delay. When the delay ends, the indoor blower motor is energized on the low fire heating speed and the HUM contacts are energized. The integrated control also initiates a second-stage on delay (factory-set at 7 minutes; adjustable to 12 minutes).
- 5 - If the heating demand continues beyond the second-stage on delay, the integrated control energizes the combustion air inducer at high speed. The control also checks the high fire (second stage) pressure switch to make sure it is closed. The high fire (second stage) gas valve is energized and the indoor blower motor is energized for operation at the high fire heating speed.
- 6 - When the thermostat heating demand is satisfied, the combustion air inducer begins a 5-second low speed post-purge. The field-selected indoor blower off delay begins. The indoor blower operates at the low-fire heating speed.
- 7 - When the combustion air post-purge period is complete, the inducer, the HUM contacts as well as the 120V ACC terminals are de-energized. The indoor blower is de-energized at the end of the off delay.

icomfort Wi-Fi® Thermostat with SL280UHV and Non-Communicating Outdoor Unit

icomfort Wi-Fi® Thermostat
icomfort™ -Enabled SL280UHV Indoor Furnace
Non-Communicating Outdoor Air Conditioner

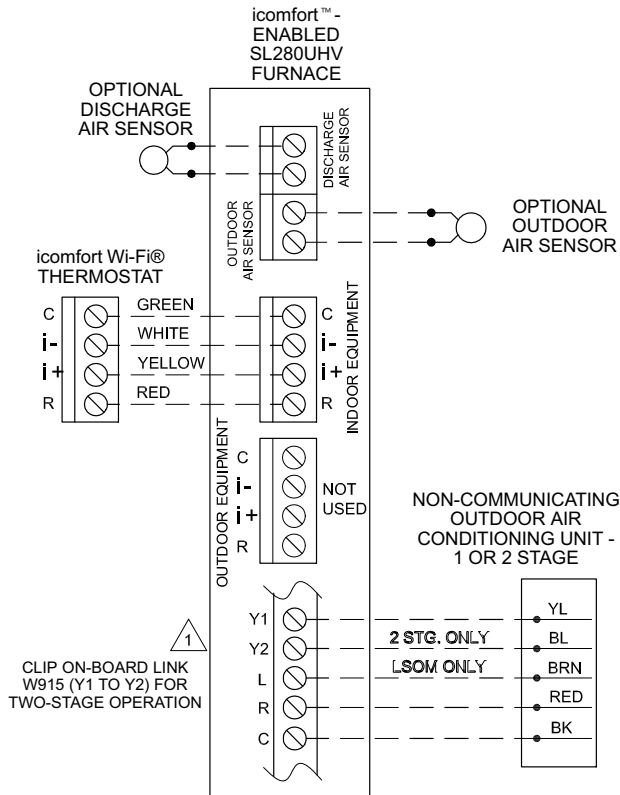

icomfort Wi-Fi® Thermostat with SL280UHV and icomfort™ -ENABLED Outdoor Unit

icomfort Wi-Fi® Thermostat
icomfort™ -Enabled SL280UHV Indoor Furnace
icomfort™ -Enabled Outdoor Air Conditioner or Heat Pump

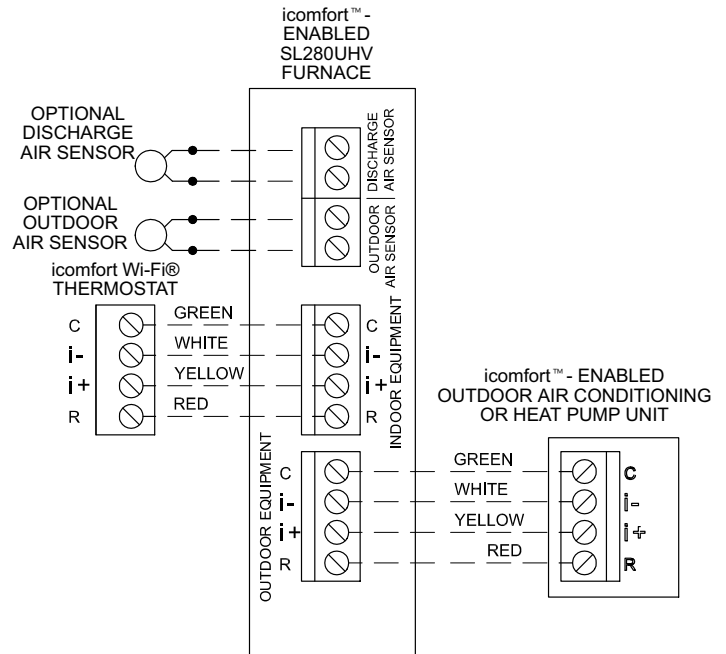

Communicating systems using the icomfort Wi-Fi® thermostat require four thermostat wires between the thermostat and the furnace/air handler control and four wires between the outdoor unit and the furnace/air handler control. When a thermostat cable with more than four wires is used, the extra wires must be properly connected to avoid electrical noise. The wires must not be left disconnected.

Use wire nuts to bundle the four unused wires at each end of the cable. A single wire should then be connected to the indoor unit end of the wire bundle and attached to the "C" terminals as shown below.

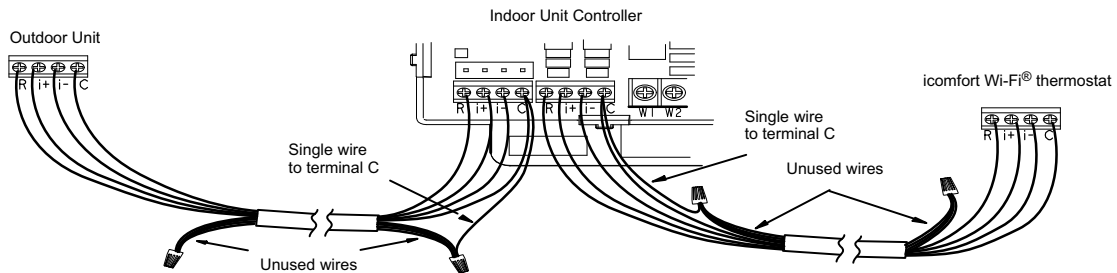

Optional Accessories for use with any icomfort Touch® System

NOTE: icomfort Wi-Fi® THERMOSTAT SENSES HUMIDITY & CONTROLS HUM CONTACTS TO CYCLE HUMIDIFIER BASED ON DEMAND. NO OTHER CONTROL OR HUMIDISTAT REQUIRED.

OPTIONAL OUTDOOR AIR SENSOR FOR USE WITH HUMIDIFIER (IF NOT ALREADY IN THE SYSTEM FOR OTHER FUNCTIONS. BUILT INTO ALL icomfort by Lennox™ OUTDOOR UNITS).

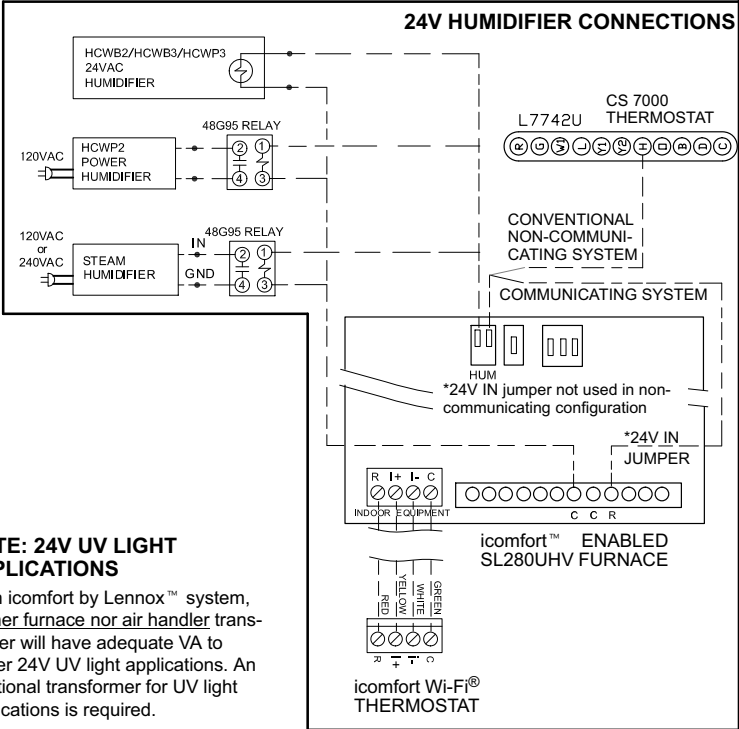
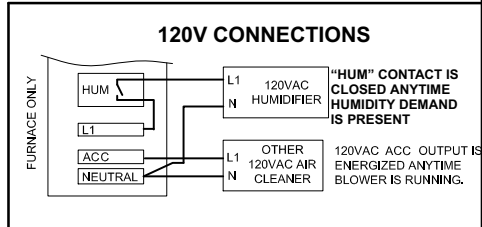

NOTE: 24V UV LIGHT APPLICATIONS

In an icomfort by Lennox™ system, neither furnace nor air handler transformer will have adequate VA to power 24V UV light applications. An additional transformer for UV light applications is required.

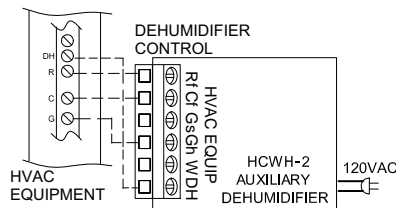
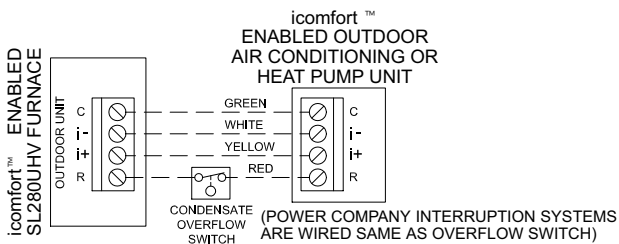
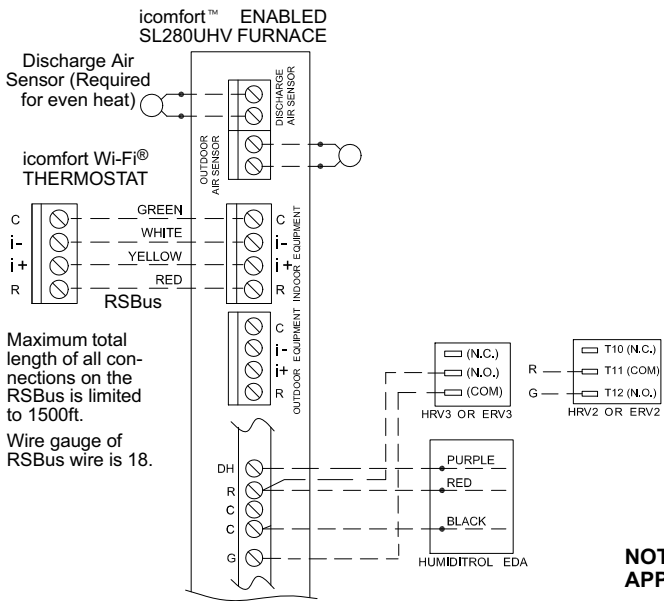

HEPA BYPASS FILTER X2680 HEPA INTERLOCK KIT

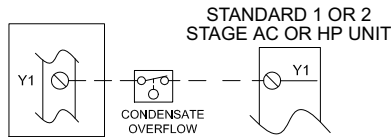
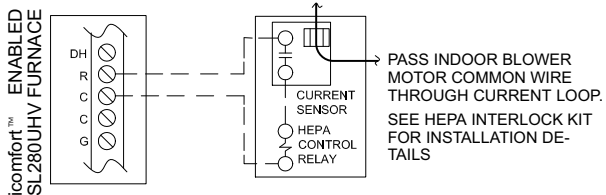

NON-COMMUNICATING SYSTEM WIRING

OTHER OUTDOOR CONNECTIONS REMAIN THE SAME. REFER TO SPECIFIC DIAGRAM

LVCS VENTILATION CONTROL SYSTEM

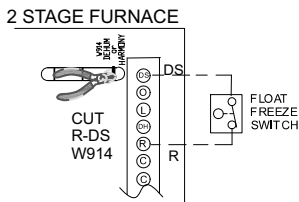
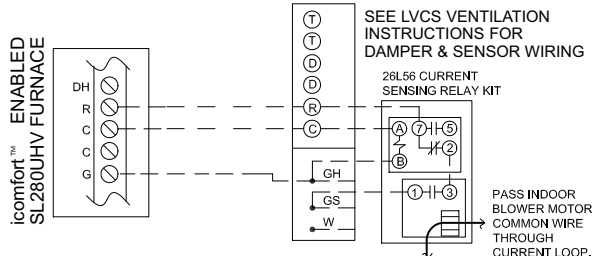

COMMUNICATING SYSTEM WIRING

VIII- SL280 Field Wiring Applications With Conventional Thermostat

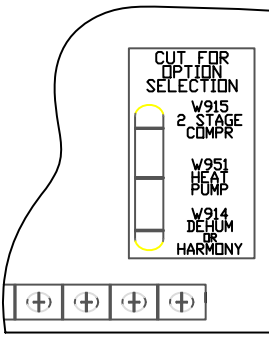
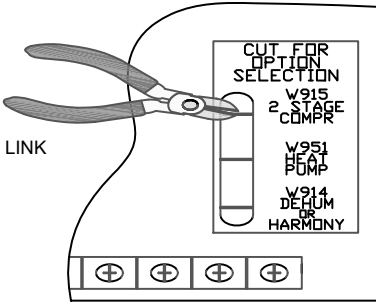
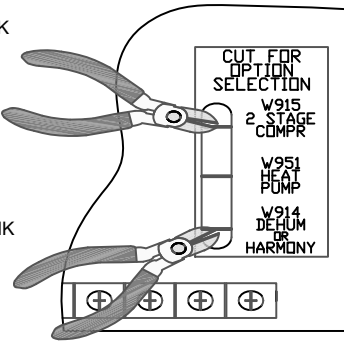
Thermostat	DIP Switch Settings and On-Board Links (See figure 4)		Wiring Connections																														
	DIP Switch 1 Thermostat Heating Stages	On Board Links Must Be Cut To Select System Options																															
1 Heat / 1 Cool <i>NOTE - Use DIP switch 2 to set second-stage heat ON delay. OFF-7 minutes. ON-12 minutes.</i>	ON	DO NOT CUT ANY ON-BOARD LINKS 	<table border="0"> <thead> <tr> <th>S1 T'STAT</th> <th>FURNACE TERM. STRIP</th> <th>OUTDOOR UNIT</th> </tr> </thead> <tbody> <tr> <td></td> <td>DS</td> <td></td> </tr> <tr> <td>W2</td> <td>W2</td> <td></td> </tr> <tr> <td>W1</td> <td>W1</td> <td></td> </tr> <tr> <td>R</td> <td>R</td> <td>* - R</td> </tr> <tr> <td>G</td> <td>G</td> <td></td> </tr> <tr> <td>C</td> <td>C</td> <td>C</td> </tr> <tr> <td></td> <td>Y2</td> <td></td> </tr> <tr> <td>Y</td> <td>Y1</td> <td>Y1</td> </tr> <tr> <td></td> <td>O</td> <td></td> </tr> </tbody> </table>	S1 T'STAT	FURNACE TERM. STRIP	OUTDOOR UNIT		DS		W2	W2		W1	W1		R	R	* - R	G	G		C	C	C		Y2		Y	Y1	Y1		O	
S1 T'STAT	FURNACE TERM. STRIP	OUTDOOR UNIT																															
	DS																																
W2	W2																																
W1	W1																																
R	R	* - R																															
G	G																																
C	C	C																															
	Y2																																
Y	Y1	Y1																															
	O																																
1 Heat / 2 Cool <i>NOTE - Use DIP switch 2 to set second-stage heat ON delay. OFF-7 minutes. ON-12 minutes.</i>	ON	CUT ON-BOARD LINK W915 2 STAGE COMPR 	<table border="0"> <thead> <tr> <th>S1 T'STAT</th> <th>FURNACE TERM. STRIP</th> <th>OUTDOOR UNIT</th> </tr> </thead> <tbody> <tr> <td></td> <td>DS</td> <td></td> </tr> <tr> <td></td> <td>W2</td> <td></td> </tr> <tr> <td>W</td> <td>W1</td> <td></td> </tr> <tr> <td>R</td> <td>R</td> <td>* - R</td> </tr> <tr> <td>G</td> <td>G</td> <td></td> </tr> <tr> <td>C</td> <td>C</td> <td>C</td> </tr> <tr> <td>Y2</td> <td>Y2</td> <td>Y2</td> </tr> <tr> <td>Y1</td> <td>Y1</td> <td>Y1</td> </tr> <tr> <td></td> <td>O</td> <td></td> </tr> </tbody> </table>	S1 T'STAT	FURNACE TERM. STRIP	OUTDOOR UNIT		DS			W2		W	W1		R	R	* - R	G	G		C	C	C	Y2	Y2	Y2	Y1	Y1	Y1		O	
S1 T'STAT	FURNACE TERM. STRIP	OUTDOOR UNIT																															
	DS																																
	W2																																
W	W1																																
R	R	* - R																															
G	G																																
C	C	C																															
Y2	Y2	Y2																															
Y1	Y1	Y1																															
	O																																
1 Heat / 2 Cool with t'stat with humidity control <i>NOTE - Use DIP switch 2 to set second-stage heat ON delay. OFF-7 minutes. ON-12 minutes.</i>	ON	CUT ON-BOARD LINK W915 2 STAGE COMPR CUT ON-BOARD LINK W914 DEHUM OR HARMONY 	<table border="0"> <thead> <tr> <th>S1 T'STAT</th> <th>FURNACE TERM. STRIP</th> <th>OUTDOOR UNIT</th> </tr> </thead> <tbody> <tr> <td>DS</td> <td>DS</td> <td></td> </tr> <tr> <td></td> <td>W2</td> <td></td> </tr> <tr> <td>W1</td> <td>W1</td> <td></td> </tr> <tr> <td>R</td> <td>R</td> <td>* - R</td> </tr> <tr> <td>G</td> <td>G</td> <td></td> </tr> <tr> <td>C</td> <td>C</td> <td>C</td> </tr> <tr> <td>Y2</td> <td>Y2</td> <td>Y2</td> </tr> <tr> <td>Y1</td> <td>Y1</td> <td>Y1</td> </tr> <tr> <td></td> <td>O</td> <td></td> </tr> </tbody> </table>	S1 T'STAT	FURNACE TERM. STRIP	OUTDOOR UNIT	DS	DS			W2		W1	W1		R	R	* - R	G	G		C	C	C	Y2	Y2	Y2	Y1	Y1	Y1		O	
S1 T'STAT	FURNACE TERM. STRIP	OUTDOOR UNIT																															
DS	DS																																
	W2																																
W1	W1																																
R	R	* - R																															
G	G																																
C	C	C																															
Y2	Y2	Y2																															
Y1	Y1	Y1																															
	O																																

* Not required on all units.

SL280 Field Wiring Applications With Conventional Thermostat (Continued)

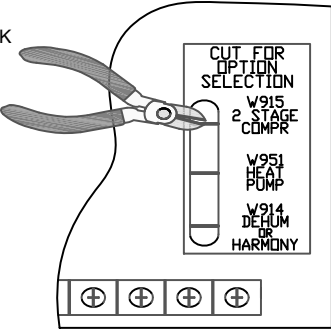
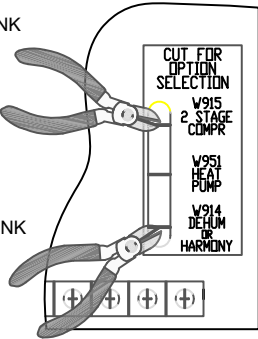
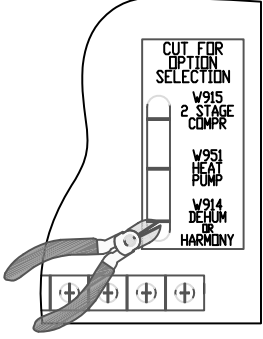
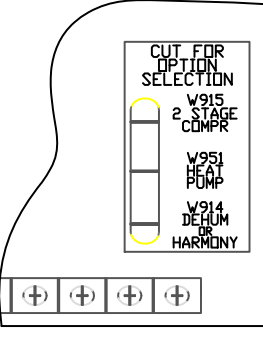
Thermostat	DIP Switch Settings and On-Board Links (See figure 4)		Wiring Connections																														
	DIP Switch 1 Thermostat Heating Stages	On Board Links Must Be Cut To Select System Options																															
2 Heat / 2 Cool	OFF	<p>CUT ON-BOARD LINK W915 2 STAGE COMPR</p> 	<table border="0"> <tr> <td>S1 T'STAT</td> <td>FURNACE TERM. STRIP</td> <td>OUTDOOR UNIT</td> </tr> <tr> <td>(W2)-----</td> <td>(W2)</td> <td></td> </tr> <tr> <td>(W1)-----</td> <td>(W1)</td> <td></td> </tr> <tr> <td>(R)-----</td> <td>(R)-----*</td> <td>(R)</td> </tr> <tr> <td>(G)-----</td> <td>(G)</td> <td></td> </tr> <tr> <td>(C)-----</td> <td>(C)-----</td> <td>(C)</td> </tr> <tr> <td>(Y2)-----</td> <td>(Y2)-----</td> <td>(Y2)</td> </tr> <tr> <td>(Y1)-----</td> <td>(Y1)-----</td> <td>(Y1)</td> </tr> <tr> <td></td> <td>(O)</td> <td></td> </tr> </table>	S1 T'STAT	FURNACE TERM. STRIP	OUTDOOR UNIT	(W2)-----	(W2)		(W1)-----	(W1)		(R)-----	(R)-----*	(R)	(G)-----	(G)		(C)-----	(C)-----	(C)	(Y2)-----	(Y2)-----	(Y2)	(Y1)-----	(Y1)-----	(Y1)		(O)				
S1 T'STAT	FURNACE TERM. STRIP	OUTDOOR UNIT																															
(W2)-----	(W2)																																
(W1)-----	(W1)																																
(R)-----	(R)-----*	(R)																															
(G)-----	(G)																																
(C)-----	(C)-----	(C)																															
(Y2)-----	(Y2)-----	(Y2)																															
(Y1)-----	(Y1)-----	(Y1)																															
	(O)																																
2 Heat / 2 Cool with t'stat with humidity control	OFF	<p>CUT ON-BOARD LINK W915 2 STAGE COMPR</p> <p>CUT ON-BOARD LINK W914 DEHUM OR HARMONY</p> 	<table border="0"> <tr> <td>S1 T'STAT</td> <td>FURNACE TERM. STRIP</td> <td>OUTDOOR UNIT</td> </tr> <tr> <td>(DS)-----</td> <td>(DS)</td> <td></td> </tr> <tr> <td>(W2)-----</td> <td>(W2)</td> <td></td> </tr> <tr> <td>(W1)-----</td> <td>(W1)</td> <td></td> </tr> <tr> <td>(R)-----</td> <td>(R)-----*</td> <td>(R)</td> </tr> <tr> <td>(G)-----</td> <td>(G)</td> <td></td> </tr> <tr> <td>(C)-----</td> <td>(C)-----</td> <td>(C)</td> </tr> <tr> <td>(Y2)-----</td> <td>(Y2)-----</td> <td>(Y2)</td> </tr> <tr> <td>(Y1)-----</td> <td>(Y1)-----</td> <td>(Y1)</td> </tr> <tr> <td></td> <td>(O)</td> <td></td> </tr> </table>	S1 T'STAT	FURNACE TERM. STRIP	OUTDOOR UNIT	(DS)-----	(DS)		(W2)-----	(W2)		(W1)-----	(W1)		(R)-----	(R)-----*	(R)	(G)-----	(G)		(C)-----	(C)-----	(C)	(Y2)-----	(Y2)-----	(Y2)	(Y1)-----	(Y1)-----	(Y1)		(O)	
S1 T'STAT	FURNACE TERM. STRIP	OUTDOOR UNIT																															
(DS)-----	(DS)																																
(W2)-----	(W2)																																
(W1)-----	(W1)																																
(R)-----	(R)-----*	(R)																															
(G)-----	(G)																																
(C)-----	(C)-----	(C)																															
(Y2)-----	(Y2)-----	(Y2)																															
(Y1)-----	(Y1)-----	(Y1)																															
	(O)																																
2 Heat / 1 Cool with t'stat with humidity control	OFF	<p>CUT ON-BOARD LINK W914 DEHUM OR HARMONY</p> 	<table border="0"> <tr> <td>S1 T'STAT</td> <td>FURNACE TERM. STRIP</td> <td>OUTDOOR UNIT</td> </tr> <tr> <td>(DS)-----</td> <td>(DS)</td> <td></td> </tr> <tr> <td>(W2)-----</td> <td>(W2)</td> <td></td> </tr> <tr> <td>(W1)-----</td> <td>(W1)</td> <td></td> </tr> <tr> <td>(R)-----</td> <td>(R)-----*</td> <td>(R)</td> </tr> <tr> <td>(G)-----</td> <td>(G)</td> <td></td> </tr> <tr> <td>(C)-----</td> <td>(C)-----</td> <td>(C)</td> </tr> <tr> <td>(Y1)-----</td> <td>(Y1)-----</td> <td>(Y1)</td> </tr> <tr> <td></td> <td>(O)</td> <td></td> </tr> </table>	S1 T'STAT	FURNACE TERM. STRIP	OUTDOOR UNIT	(DS)-----	(DS)		(W2)-----	(W2)		(W1)-----	(W1)		(R)-----	(R)-----*	(R)	(G)-----	(G)		(C)-----	(C)-----	(C)	(Y1)-----	(Y1)-----	(Y1)		(O)				
S1 T'STAT	FURNACE TERM. STRIP	OUTDOOR UNIT																															
(DS)-----	(DS)																																
(W2)-----	(W2)																																
(W1)-----	(W1)																																
(R)-----	(R)-----*	(R)																															
(G)-----	(G)																																
(C)-----	(C)-----	(C)																															
(Y1)-----	(Y1)-----	(Y1)																															
	(O)																																
2 Heat / 1 Cool	OFF	<p>DO NOT CUT ANY ON-BOARD LINKS</p> 	<table border="0"> <tr> <td>S1 T'STAT</td> <td>FURNACE TERM. STRIP</td> <td>OUTDOOR UNIT</td> </tr> <tr> <td></td> <td>(DS)</td> <td></td> </tr> <tr> <td>(W2)-----</td> <td>(W2)</td> <td></td> </tr> <tr> <td>(W1)-----</td> <td>(W1)</td> <td></td> </tr> <tr> <td>(R)-----</td> <td>(R)-----*</td> <td>(R)</td> </tr> <tr> <td>(G)-----</td> <td>(G)</td> <td></td> </tr> <tr> <td>(C)-----</td> <td>(C)-----</td> <td>(C)</td> </tr> <tr> <td></td> <td>(Y2)</td> <td></td> </tr> <tr> <td>(Y)-----</td> <td>(Y1)-----</td> <td>(Y1)</td> </tr> <tr> <td></td> <td>(O)</td> <td></td> </tr> </table>	S1 T'STAT	FURNACE TERM. STRIP	OUTDOOR UNIT		(DS)		(W2)-----	(W2)		(W1)-----	(W1)		(R)-----	(R)-----*	(R)	(G)-----	(G)		(C)-----	(C)-----	(C)		(Y2)		(Y)-----	(Y1)-----	(Y1)		(O)	
S1 T'STAT	FURNACE TERM. STRIP	OUTDOOR UNIT																															
	(DS)																																
(W2)-----	(W2)																																
(W1)-----	(W1)																																
(R)-----	(R)-----*	(R)																															
(G)-----	(G)																																
(C)-----	(C)-----	(C)																															
	(Y2)																																
(Y)-----	(Y1)-----	(Y1)																															
	(O)																																

* Not required on all units.

SL280 Field Wiring Applications With Conventional Thermostat (Continued)

Thermostat	DIP Switch Settings and On-Board Links (figure 4)		Wiring Connections																																													
	DIP Switch 1 Thermostat Heating Stages	On Board Links Must Be Cut To Select System Options																																														
Dual Fuel Single Stage Heat Pump ComfortSense 7000 L7742U thermostat w/ dual fuel capabilities Capable of 2 stage gas heat control	OFF		<table border="0"> <tr> <td>L7742U T*STAT</td> <td>FURNACE TERM. STRIP</td> <td>HEAT PUMP</td> </tr> <tr> <td>(R)-----</td> <td>(R)-----</td> <td>(R)</td> </tr> <tr> <td>(H)-----</td> <td></td> <td></td> </tr> <tr> <td>(W2)-----</td> <td>(W2)-----</td> <td>67M41*</td> </tr> <tr> <td>(W1)-----</td> <td>(W1)-----</td> <td>(W1) ← [Switch] → (W1)</td> </tr> <tr> <td>(O)-----</td> <td>(O)-----</td> <td>(O)</td> </tr> <tr> <td>(L)-----</td> <td></td> <td>(L)</td> </tr> <tr> <td>(Y1)-----</td> <td>(Y1)-----</td> <td>(Y)</td> </tr> <tr> <td>(Y2)-----</td> <td></td> <td></td> </tr> <tr> <td>(G)-----</td> <td>(G)-----</td> <td></td> </tr> <tr> <td>(D)-----</td> <td>(DS)-----</td> <td></td> </tr> <tr> <td>(B)-----</td> <td>(Y2)-----</td> <td></td> </tr> <tr> <td>(C)-----</td> <td>(C)-----</td> <td>(C)</td> </tr> <tr> <td>(T)-----</td> <td></td> <td>[Outdoor sensor]</td> </tr> <tr> <td>(T)-----</td> <td></td> <td></td> </tr> </table>	L7742U T*STAT	FURNACE TERM. STRIP	HEAT PUMP	(R)-----	(R)-----	(R)	(H)-----			(W2)-----	(W2)-----	67M41*	(W1)-----	(W1)-----	(W1) ← [Switch] → (W1)	(O)-----	(O)-----	(O)	(L)-----		(L)	(Y1)-----	(Y1)-----	(Y)	(Y2)-----			(G)-----	(G)-----		(D)-----	(DS)-----		(B)-----	(Y2)-----		(C)-----	(C)-----	(C)	(T)-----		[Outdoor sensor]	(T)-----		
L7742U T*STAT	FURNACE TERM. STRIP	HEAT PUMP																																														
(R)-----	(R)-----	(R)																																														
(H)-----																																																
(W2)-----	(W2)-----	67M41*																																														
(W1)-----	(W1)-----	(W1) ← [Switch] → (W1)																																														
(O)-----	(O)-----	(O)																																														
(L)-----		(L)																																														
(Y1)-----	(Y1)-----	(Y)																																														
(Y2)-----																																																
(G)-----	(G)-----																																															
(D)-----	(DS)-----																																															
(B)-----	(Y2)-----																																															
(C)-----	(C)-----	(C)																																														
(T)-----		[Outdoor sensor]																																														
(T)-----																																																
Dual Fuel Two Stage Heat Pump ComfortSense 7000 L7742U thermostat w/ dual fuel capabilities Capable of 2 stage gas heat control	OFF		<table border="0"> <tr> <td>L7742U T*STAT</td> <td>FURNACE TERM. STRIP</td> <td>HEAT PUMP</td> </tr> <tr> <td>(R)-----</td> <td>(R)-----</td> <td>(R)</td> </tr> <tr> <td>(H)-----</td> <td></td> <td></td> </tr> <tr> <td>(W2)-----</td> <td>(W2)-----</td> <td>67M41*</td> </tr> <tr> <td>(W1)-----</td> <td>(W1)-----</td> <td>(W1) ← [Switch] → (W1)</td> </tr> <tr> <td>(O)-----</td> <td>(O)-----</td> <td>(O)</td> </tr> <tr> <td>(L)-----</td> <td></td> <td>(L)</td> </tr> <tr> <td>(Y1)-----</td> <td>(Y1)-----</td> <td>(Y1)</td> </tr> <tr> <td>(Y2)-----</td> <td></td> <td>(Y2)</td> </tr> <tr> <td>(G)-----</td> <td>(G)-----</td> <td></td> </tr> <tr> <td>(D)-----</td> <td>(DS)-----</td> <td></td> </tr> <tr> <td>(B)-----</td> <td>(Y2)-----</td> <td>Y2 out blue</td> </tr> <tr> <td>(C)-----</td> <td>(C)-----</td> <td>(C)</td> </tr> <tr> <td>(T)-----</td> <td></td> <td>[Outdoor sensor]</td> </tr> <tr> <td>(T)-----</td> <td></td> <td></td> </tr> </table>	L7742U T*STAT	FURNACE TERM. STRIP	HEAT PUMP	(R)-----	(R)-----	(R)	(H)-----			(W2)-----	(W2)-----	67M41*	(W1)-----	(W1)-----	(W1) ← [Switch] → (W1)	(O)-----	(O)-----	(O)	(L)-----		(L)	(Y1)-----	(Y1)-----	(Y1)	(Y2)-----		(Y2)	(G)-----	(G)-----		(D)-----	(DS)-----		(B)-----	(Y2)-----	Y2 out blue	(C)-----	(C)-----	(C)	(T)-----		[Outdoor sensor]	(T)-----		
L7742U T*STAT	FURNACE TERM. STRIP	HEAT PUMP																																														
(R)-----	(R)-----	(R)																																														
(H)-----																																																
(W2)-----	(W2)-----	67M41*																																														
(W1)-----	(W1)-----	(W1) ← [Switch] → (W1)																																														
(O)-----	(O)-----	(O)																																														
(L)-----		(L)																																														
(Y1)-----	(Y1)-----	(Y1)																																														
(Y2)-----		(Y2)																																														
(G)-----	(G)-----																																															
(D)-----	(DS)-----																																															
(B)-----	(Y2)-----	Y2 out blue																																														
(C)-----	(C)-----	(C)																																														
(T)-----		[Outdoor sensor]																																														
(T)-----																																																

* Connect W1 to W1 ONLY if using defrost tempering kit 67M41

NOTE - **Do NOT** make a wire connection between the room thermostat L terminal and the L terminal of the SL280 integrated control.

SL280 Field Wiring Applications With Conventional Thermostat (Continued)

Thermostat	DIP Switch Settings and On-Board Links (figure 4)		Wiring Connections
	DIP Switch 1 Thermostat Heating Stages	On Board Links Must Be Cut To Select System Options	
<p>Dual Fuel Single Stage Heat Pump</p> <p>ComfortSense 7000 L7742U thermostat w/ dual fuel capa- bilities Capable of 2 stage gas heat control w/dehu- midification control</p>	OFF	<p>CUT ON-BOARD LINK W951 HEAT PUMP</p> <p>CUT ON-BOARD LINK W914 DEHUM OR HARMONY</p>	<p>L7742U T*STAT FURNACE TERM. STRIP HEAT PUMP</p> <p>R --- R --- R</p> <p>H --- W2 --- W2 67M41*</p> <p>W1 ← W1 → W1</p> <p>O --- O --- O</p> <p>L --- L --- L</p> <p>Y1 --- Y1 --- Y</p> <p>Y2 --- G --- G</p> <p>D --- DS --- DS</p> <p>B --- Y2 --- Y2</p> <p>C --- C --- C</p> <p>T --- outdoor sensor</p> <p>T --- outdoor sensor</p>
<p>Dual Fuel Two Stage Heat Pump</p> <p>ComfortSense 7000 L7742U thermostat w/ dual fuel capa- bilities Capable of 2 stage gas heat control w/dehu- midification</p>	OFF	<p>CUT ON-BOARD LINK W915 2 STAGE COMPR</p> <p>CUT ON-BOARD LINK W951 HEAT PUMP</p> <p>CUT ON-BOARD LINK W914 DEHUM OR HARMONY</p>	<p>L7742U T*STAT FURNACE TERM. STRIP HEAT PUMP</p> <p>R --- R --- R</p> <p>H --- W2 --- W2 67M41*</p> <p>W1 ← W1 → W1</p> <p>O --- O --- O</p> <p>L --- L --- L</p> <p>Y1 --- Y1 --- Y1</p> <p>Y2 --- Y2 --- Y2</p> <p>G --- G --- G</p> <p>D --- DS --- DS</p> <p>B --- Y2 --- Y2 out blue</p> <p>C --- C --- C</p> <p>T --- outdoor sensor</p> <p>T --- outdoor sensor</p>

* Connect W1 to W1 ONLY if using defrost tempering kit 67M41

NOTE - Do NOT make a wire connection between the room thermostat L terminal and the L terminal of the SL280 integrated control.

IX- Program Unit Capacity Size Modes

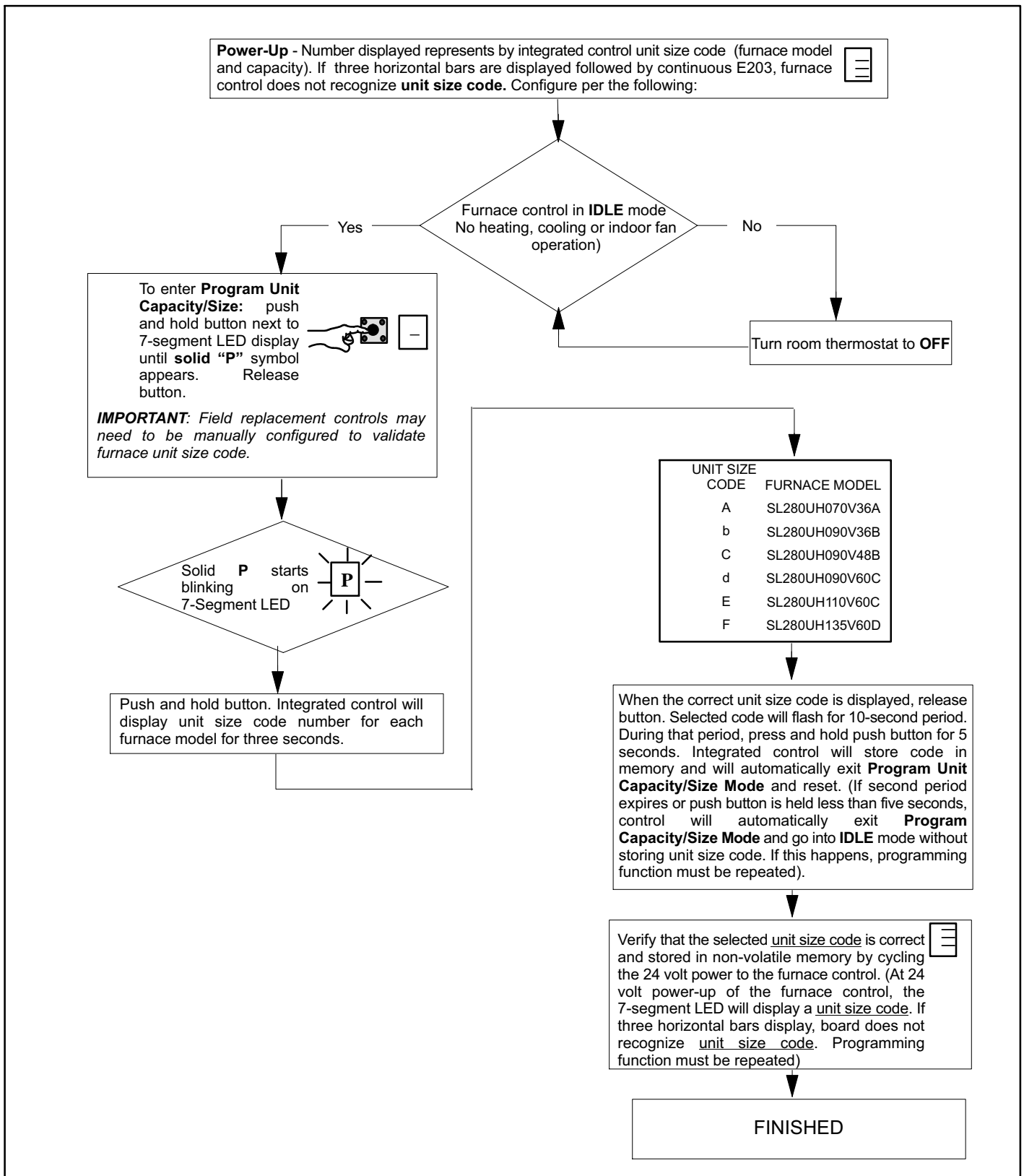

X- Troubleshooting

Troubleshooting: Heating Sequence of Operation

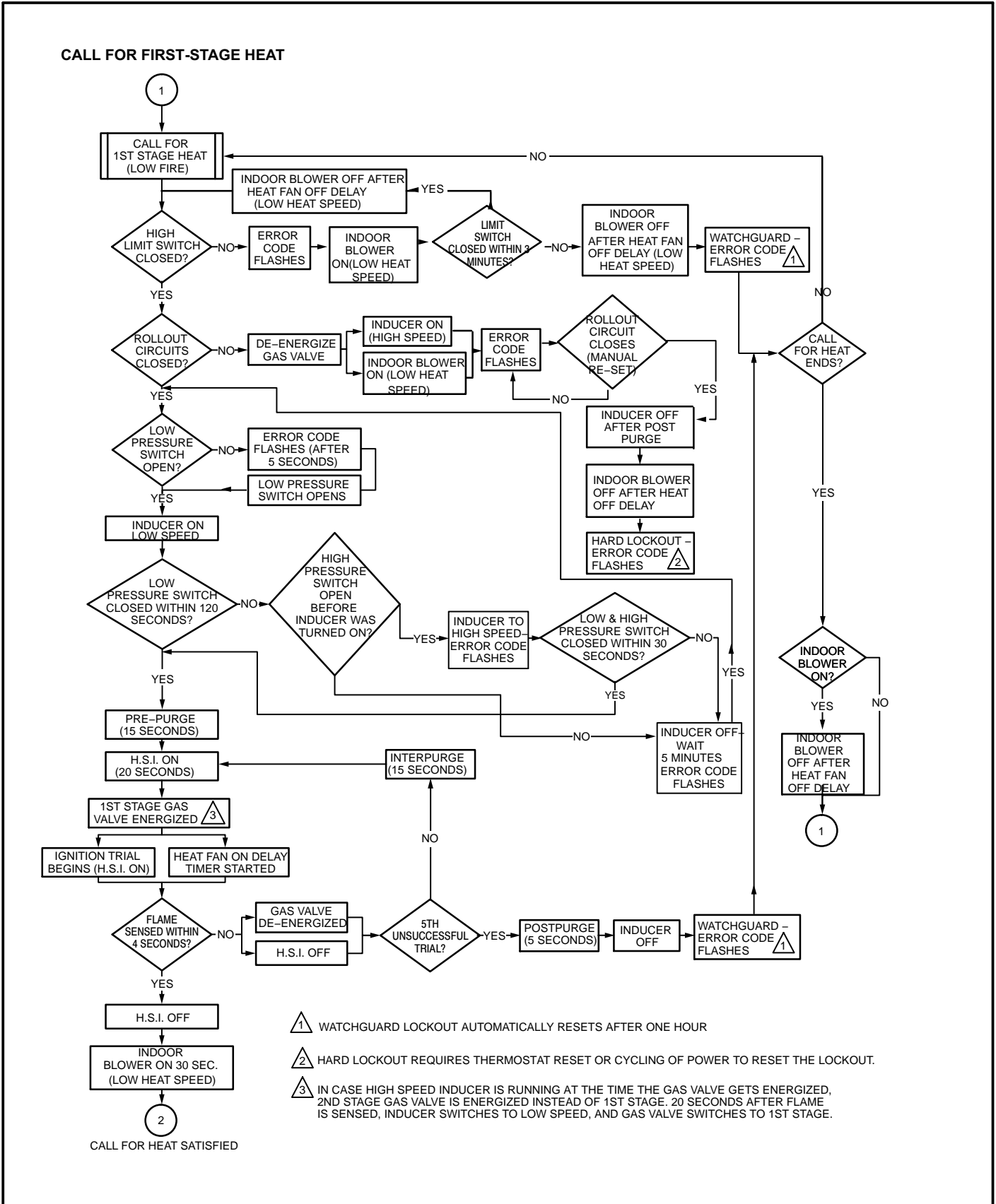

Troubleshooting: Heating Sequence of Operation (Continued)

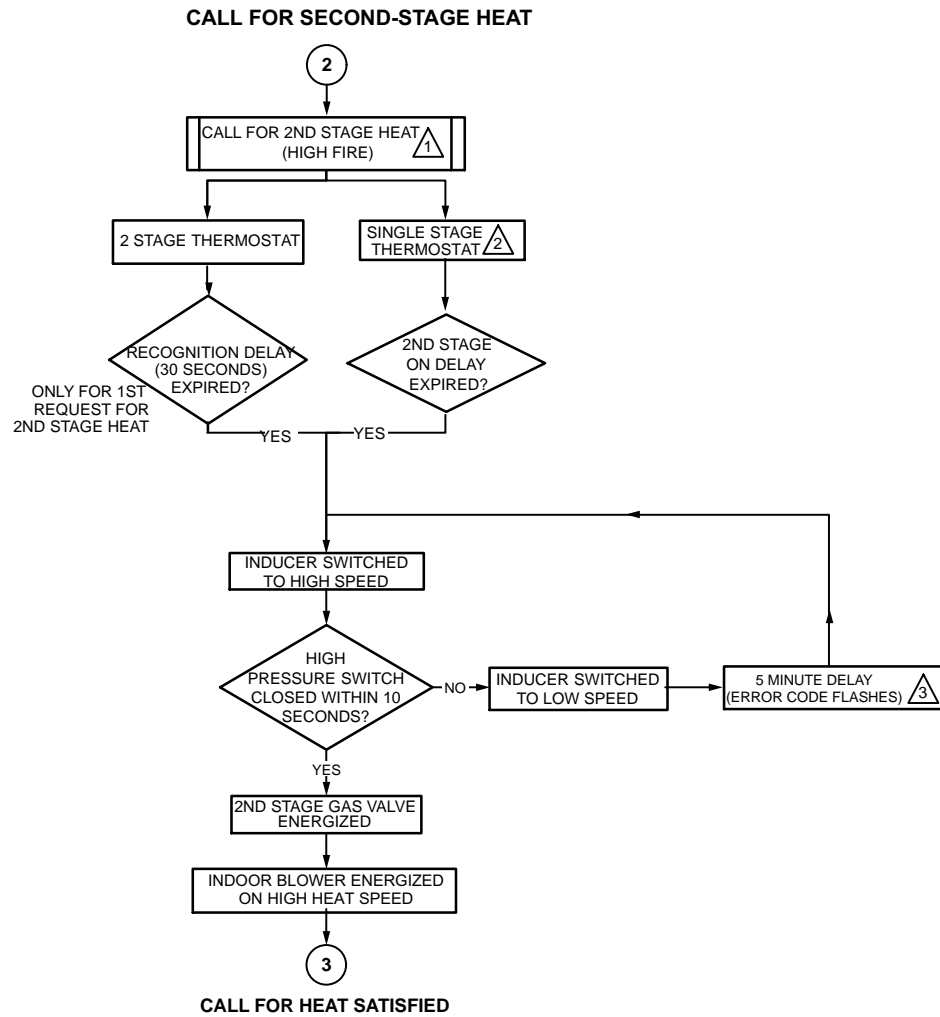

1 SYSTEM WILL ALWAYS LIGHT ON LOW FIRE, EVEN IF 2ND STAGE HEAT IS IN PLACE.

2 WHEN USED WITH A SINGLE STAGE THERMOSTAT, SET SW1 TO THE ON POSITION IN DIP SWITCH S4.

3 IF THE HIGH FIRE PRESSURE SWITCH DOES NOT CLOSE WITHIN 5 ATTEMPTS, THE SYSTEM WILL OPERATE AT LOW FIRE FOR THE REMAINDER OF THE CALL FOR HEAT REQUEST.

Troubleshooting: Heating Sequence of Operation (Continued)

CALL FOR HEAT SATISFIED

FIRST-STAGE HEAT SECOND-STAGE HEAT

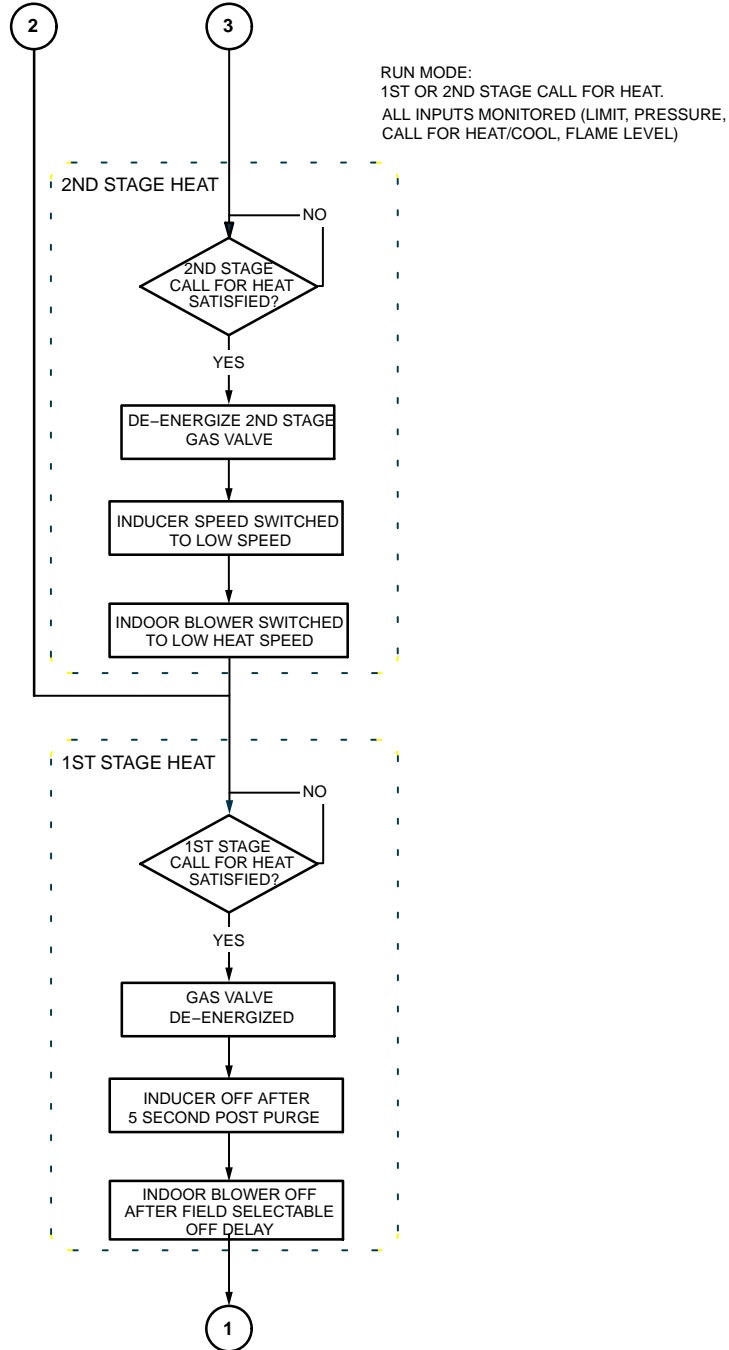

Troubleshooting: Cooling Sequence of Operation (Continued)

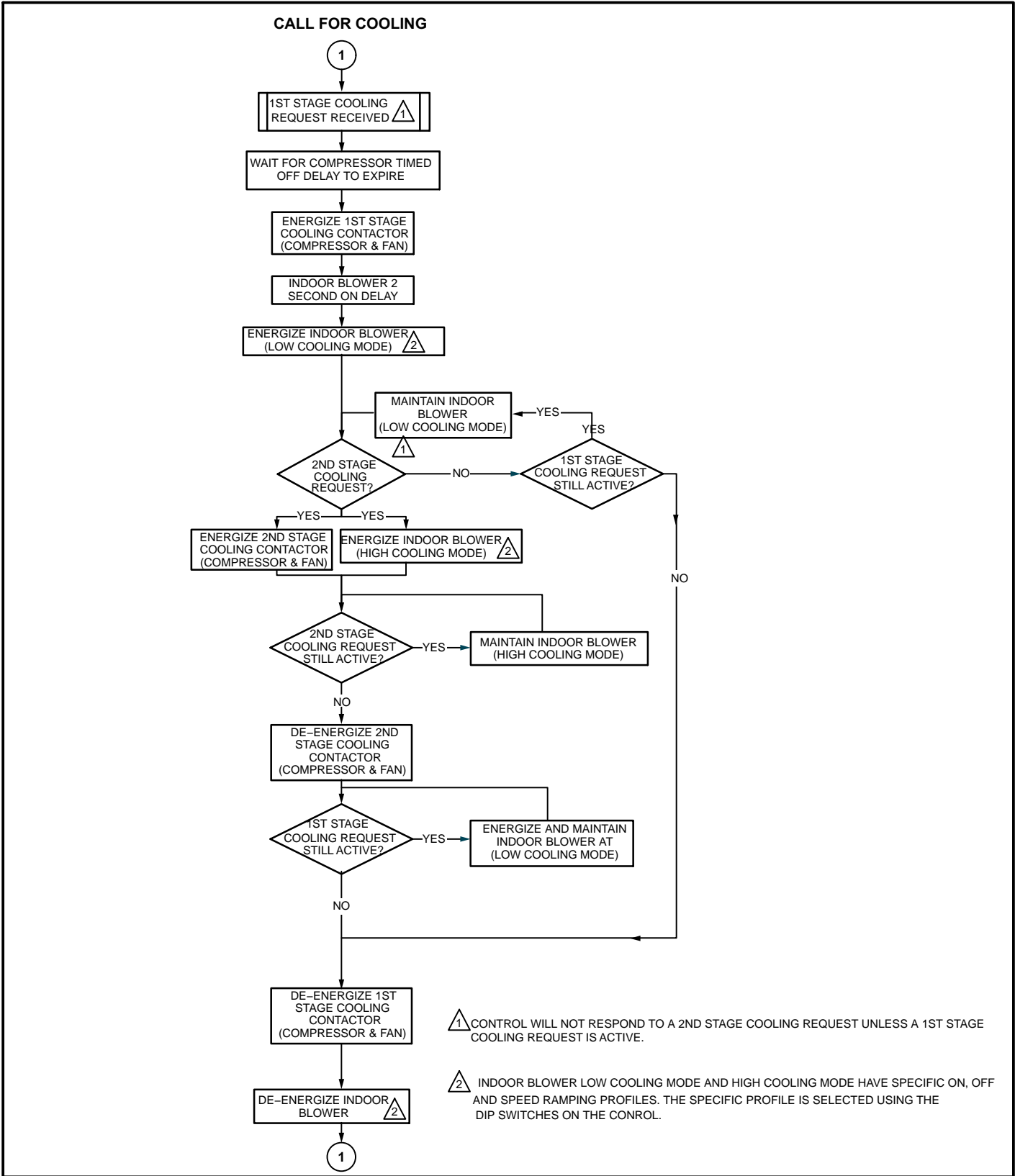

Troubleshooting: Continuous Fan Sequence of Operation

