



# iComfort® S30

## Ultra Smart Thermostat

### *Installation and Setup Guide*

507536-08 8/2020  
Supersedes 507536-06  
Copyright 2020® Lennox Industries Inc.  
Dallas, Texas, USA

# Table of Contents

Shipping and Packing List.....	3	Diagnostics.....	42	Wi-Fi Connection.....	51
Operating and Storage Environment, Electrical and Dimensions.....	3	Installation Report.....	42	Performance Reports.....	53
Smart Hub External Component Locations, Button, LEDs, Terminals, Wiring Specifications and Sensor Wiring.....	3	Information.....	43	Mobile Applications.....	53
External Component Locations.....	3	<b>Dehumidification Settings.....</b>	<b>43</b>	Notifications (Service and Alert Codes).....	53
Push Button Functions.....	4	Dehumidification Setting Options.....	43	Alert Code Types.....	53
LED Indicators.....	4	Overcooling.....	43	Soft Disable.....	54
Terminals and Wiring Recommendations.....	5	Dehumidification Set Point.....	43	Service Notification Codes.....	54
Sensor Wiring.....	6	Advanced Dehumidification Descriptions.....	44	Alert Codes.....	55
HD Display External Components.....	6	<b>Displaying Outdoor Temperature (Sensor) and Indoor Humidity on the Home Screen.....</b>	<b>45</b>	Installation Checklist.....	94
Reducing Electrical Noise.....	7	Displaying the Outdoor Sensor Temperature on the Home Screen.....	45	<b>Technical Support and Mobile App for Installers/Technicians Only.....</b>	<b>95</b>
Application Wiring.....	7	Displaying the Indoor Humidity on the Home Screen.....	45	Technical Support for Installers/Technicians Only.....	95
Installation Recommendations.....	14	<b>iHarmony Zoning.....</b>	<b>45</b>	iComfort Mobile Setup Application for Installers/Technicians Only.....	95
Smart Hub Installation.....	14	<b>PureAir S.....</b>	<b>45</b>	LennoxPros Mobile Application for Installers/Technicians Only.....	95
HD Display Installation.....	15	<b>Ventilation (ERV, HRV and Fresh Air Damper).....</b>	<b>45</b>	<b>LennoxPros Dealer Dashboard.....</b>	<b>95</b>
Installation.....	15	Ventilation Rates.....	45	Service Dashboard Search Screen.....	95
Mounting Display to Subbase.....	16	Energy Recovery Ventilator (ERV).....	46	Customer Results Screen.....	95
<b>Lennox Communicating Air Handler Electric Heat Configuration.....</b>	<b>16</b>	Heat Recovery Ventilator (HRV).....	46	Customer Details Screen.....	96
Auto Detection.....	16	Fresh Air Damper.....	46	<b>Summary of Changes.....</b>	<b>96</b>
Manual Configuration.....	16	Zoning Application.....	46	<b>Index.....</b>	<b>99</b>
<b>Commissioning and Service (Using the Mobile Setup Application).....</b>	<b>17</b>	Operation of Fresh Air Dampers with Environmental Overrides.....	46		
Mobile Device Operating System Requirements.....	17	Wiring.....	46		
Establishing a Direct Wireless Connection to the Smart Hub.....	17	Ventilation Control Modes.....	46		
Service.....	18	<b>Communicating System Configurations.....</b>	<b>47</b>		
Alternative Method.....	18	Furnace and Air Conditioner.....	47		
<b>Commissioning (Using the HD Display).....</b>	<b>19</b>	Furnace and HP Unit (Dual-Fuel).....	47		
Apple HomeKit Wi-Fi Accessory Configuration.....	19	Air Handler and Air Conditioner.....	48		
Dealer Info.....	19	Air Handler and Heat Pump Unit.....	48		
General Information.....	19	<b>Hybrid System Configurations.....</b>	<b>49</b>		
Equipment Found Screen.....	20	Communicating Furnace and Conventional Air Conditioner.....	49		
Reminders.....	20	Communicating Furnace and Conventional Heat Pump Unit (Dual Fuel).....	49		
iHarmony Zoning.....	20	Communicating Air Handler and Conventional Air Conditioner.....	50		
Commissioning Completion.....	21	Communicating Air Handler and Conventional Heat Pump Unit.....	50		
Equipment Parameters.....	23	Equipment Interface Module.....	51		
Tests.....	42	<b>SLP98V Variable Capacity Furnace Default Setting.....</b>	<b>51</b>		

## Shipping and Packing List

Table 1. Packing List

Quantity	Description
1	iComfort S30 ultra smart thermostat includes a smart hub and HD Display
4	Mounting screws (#6 X 1.25" pan head)
4	Wall anchors (alligator flanged solid wall anchors)
1	Installation and setup guide
1	User guide
1	Warranty certificate

**NOTE:** Due to Lennox' ongoing commitment to quality, features and options are subject to change without notice and without incurring liability. Improper installation, adjustment, alteration, service or maintenance can cause property damage or personal injury. Installation and service must be performed by a qualified installer and servicing agency.

## Operating and Storage Environment, Electrical and Dimensions

- Operating temperature is 32°F to 104°F (0 to 40°C)
- Shipping and storage temperature range is -4°F to 140°F (-20°C to 60°C)
- Operating humidity range is 10% to 90% non-condensing at 104°F (40°C)
- Storage humidity range is 5% to 95% non-condensing at 104°F (40°C)
- Smart Hub Power Input: 24VAC, 1AMP at 60Hz.
- Smart Hub Power Output to HD Display: 12VDC
- Dimensions (H x W x D):
  - » HD Display: 7-1/4" x 5" x 1" (184 x 122.5 x 23 mm)
  - » Smart Hub: 4-1/2 x 4-1/2 x 1-1/2" (114 x 114 x 38 mm) - antenna length is 7-1/4" (184 mm)

## Smart Hub External Component Locations, Button, LEDs, Terminals, Wiring Specifications and Sensor Wiring

### External Component Locations

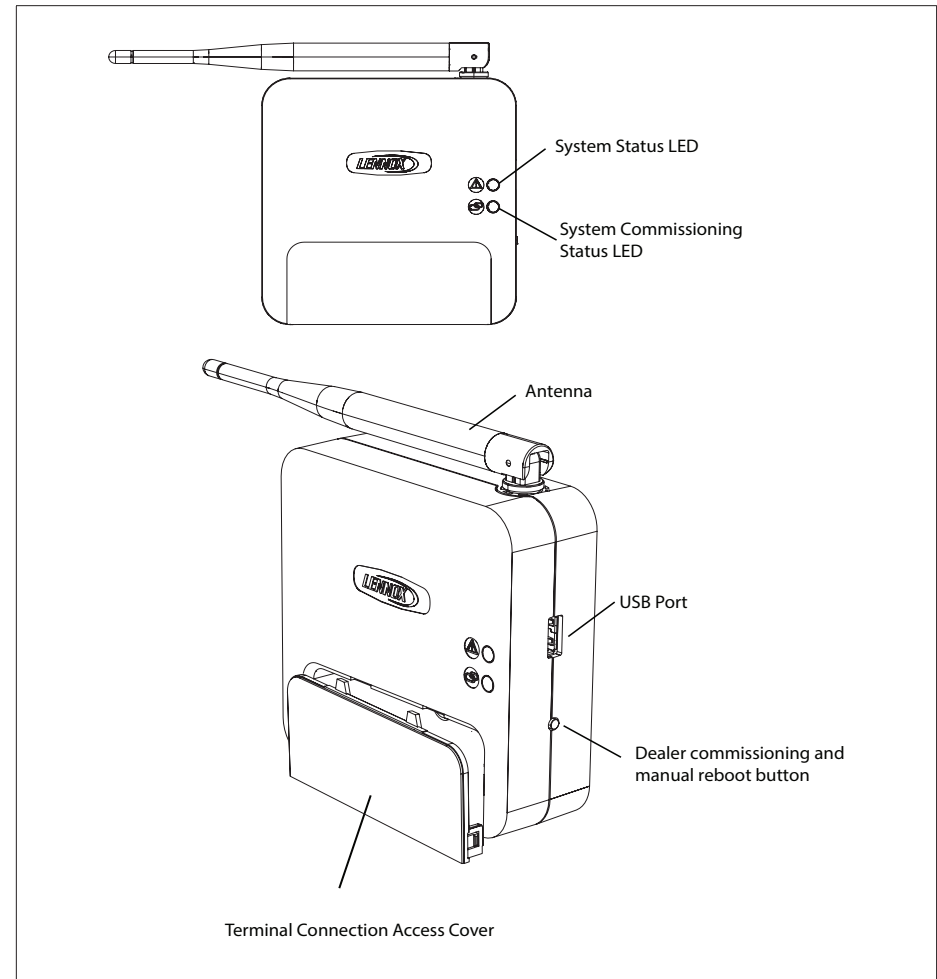

Figure 1. Smart Hub Indicators and External Components

## Push Button Functions

The smart hub push button switch has two primary functions.

- **Rebooting:** Press and hold the button for five seconds to reboot the smart hub.
- **Commissioning:** Quickly press and release the button to start the process of creating a direct network connection between the smart hub and mobile device running the iComfort Mobile Setup application.

The push button has a LED associated with it that indicates the status of the smart hub commissioning state (see “Table 3. Commissioning LED Indicators”).

## LED Indicators

When alarms are present, you may review alarm(s) listed either on the homeowner notification screen or the **menu / settings > advanced settings > dealer control center > notifications** screen.

Alert codes which require manual clearing can only be done under the **dealer control center > notification** screen.

**Table 2. System Status LED Indicators**

	<b>System Status LED</b>	
LED Color	Status	Description
<b>Green</b>	System is normal	A solid green LED indicates no system errors are detected. System operating as designed.
<b>Red</b>	HVAC Fault	System has critical alert which needs attention.
<b>Amber</b>	Wi-Fi Error	Blinking amber LED indicates either Wi-Fi is not connected, no Wi-Fi is within range, or and Wi-Fi hardware error. Could also indicate intermittent Wi-Fi connection.
<b>Magenta</b>	Thermostat Error	Blinking magenta LED indicates HD display not connected. (See “Table 4. Communication Error Troubleshooting (HD Display to smart hub)”.
<b>Cyan</b>	HVAC Error	Indoor unit is not connected or unable to communicate.

**Table 3. Commissioning LED Indicators**

	<b>Commissioning Status LED</b>	
LED Color	Status	Description
<b>Blue</b>	System is normal	No mobile device is directly connected using Wi-Fi to the smart hub.
<b>Green</b>	Blinking green LED	Blinking green LED indicates the commissioning button has been activated and the smart hub is waiting for a connection with a mobile device.
<b>Green</b>	A solid green LED	A solid green LED indicates a mobile device is connected to the smart hub.

- If multiple errors are present, the system status LED will display each active error for one second on and one second off and then display the next error if present.
- The system will continue to cycle through all active errors.
- System status errors are displayed in the following priority: HVAC , thermostat and then Wi-Fi.

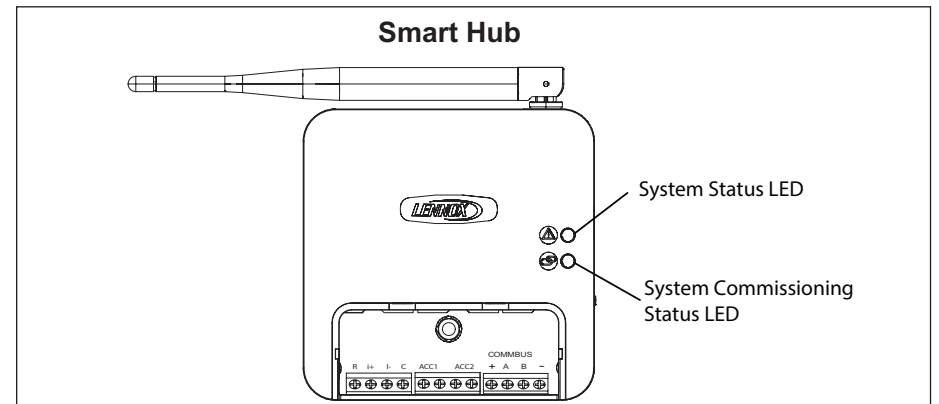

**Table 4. Communication Error Troubleshooting  
(HD Display to smart hub)**

Possible Connection Issues	S30 smart hub - System Status LED
One communication wire at the smart hub COMM BUS A or B terminals is disconnected.	Flashing Magenta LED
Both communication wires – at the smart hub COMM BUS A or B terminals are reversed.	Flashing Magenta LED
Power wires at smart hub 12VDC + and - terminals are disconnected.	Flashing Magenta LED.
If terminals are connected correctly, then check HD Display to subbase attachment. Verify the display is securely fasten to subbase and horizontally aligned.	Flashing Magenta LED. HD Display screen may be either blank or a message indicating iComfort cannot communicate with the equipment.

**Terminals and Wiring Recommendations**

**Table 5. Terminal Designations and Wiring Recommendations**

Terminal Designation	Description	Thermostat Wiring	Typical Wiring
R	24VAC input	18AWG unshielded	<p>Outdoor Unit</p> <p>Indoor Unit Controller</p> <p>Smart Hub</p> <p>HD Display Subbase</p> <p>DO NOT connect shield wire</p> <p>18AWG unshielded</p> <p>18 or 22AWG shielded</p> <p>18AWG unshielded</p> <p>18 or 22AWG shielded</p> <p>18 AWG Unshielded</p> <p>18 or 22AWG shielded</p> <p>Shield wire needs to be connected to a common (C) terminal.</p>
C	24VAC return		
I+	RS-BUS I+	18 - 22AWG shielded (recommended)	
I-	RS-BUS I-	18AWG unshielded	
ACC1	Accessory 1 and 2 (typically can be used for 1 or 2 speed ventilators and fresh air damper)		
ACC2			
+	12VDC output	18AWG unshielded	
-	12VDC return	18 - 22AWG shielded (recommended)	
A	Communications bus A		
B	Communications bus B		

**IMPORTANT**

Use 1-pair, 18AWG unshielded thermostat cable (field-provided) for power terminals (R, C, 12+ AND 12-). We highly recommend using 18 - 22AWG shielded thermostat cable for communications terminals (I+, I-, A and B) which will help eliminate any noise interference.

## Sensor Wiring

The following diagrams in this section illustrates the basic Lennox control wiring for all compatible components.

### **Discharge Air Temperature Sensor (DATS)**

The optional discharge air temperature sensor (DATS) (88K38) wiring distance to the iComfort S30 should not exceed 150 feet (45 meters) when wired with minimum 22 #AWG (recommend 18 #AWG) dedicated 1-pair thermostat cable. Installation of DATS must comply with the following requirements:

- Installed downstream of the heat exchanger or electric heat elements.
- Must be placed in free airflow, where other accessories (such as humidifiers, UV lights, etc.) will not interfere with accuracy.
- Wiring distance between the furnace, air handler or damper control module controls and the discharge air sensor must not exceed 10 feet (3 meters) when wired with 18# AWG thermostat wire.
- DATS use is highly recommended for all systems that include a variable capacity outdoor unit in order to provide more precise dehumidification operation.

### **Outdoor Air Temperature Sensor (OATS)**

The optional outdoor air (temperature) sensor (OATS) (X2658) wiring distance to the iComfort S30 should not exceed 150 feet (45 meters) when wired with minimum 22 #AWG (recommend 18 #AWG) dedicated 1-pair thermostat cable. Installation of OATS must comply with the following requirements:

- Sensor wiring must be run to avoid touching or being close to high voltage wiring and light ballast.
- Choose a protected outdoor location away from direct sunlight or other heat sources (usually on the north side of the building).
- Ensure that water will neither collect on, nor wash over the sensor.
- Do not locate the sensor near driveways or similar heat-absorbing masses which may reflect stored heat energy onto the sensor and send inaccurate information to the thermostat.
- Locate the sensor away from attic and soffit vents, or furnace venting pipes.
- Do not locate the sensor directly above an air conditioner or heat pump.

## HD Display External Components

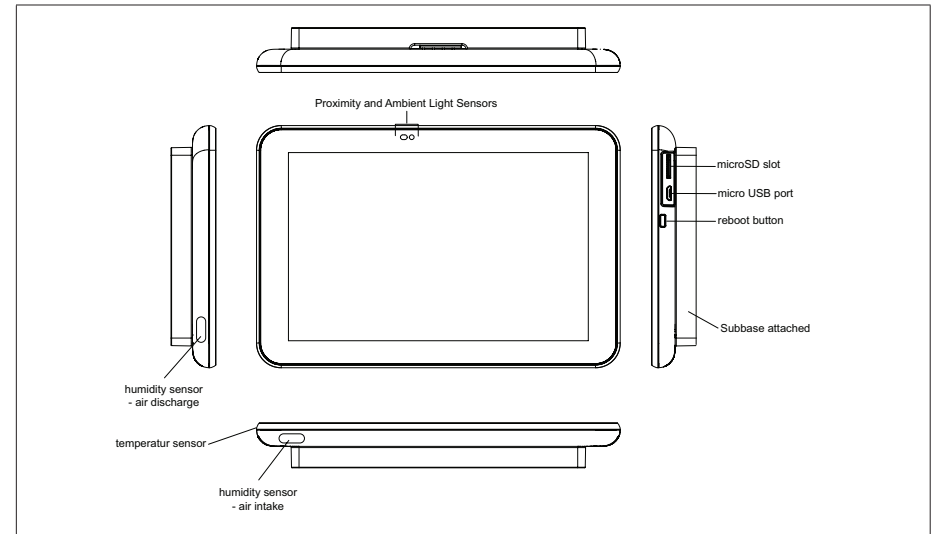

**Figure 2. HD Display 3.0 Components**

- **Proximity sensor** - Detects a person approaching the HD Display. If the HD Display is in screen saver mode and the proximity sensor setting is enabled (factory default is ON), the proximity sensor takes the HD Display out of screen saver mode automatically and returns to the home screen when someone approaches. This feature can be disabled by going to **menu > setting > display**.
- **Humidity sensor** - This is the intake location for the built-in humidity sensor. Do not block the intake location. The indoor humidity percentage is displayed (enabled by default) on the home screen. The humidity percentage display on the home screen can be disabled by going to **menu > setting > display**.
- **Reboot button** - Press and hold this button for approximately six (6) seconds to reboot the HD display. No settings are lost using this procedure.
- **MicroSD card slot** - For future use.
- **Micro USB connector** - For future use.

## Reducing Electrical Noise

Communicating systems requires four thermostat wires between the HD Display and smart hub. Four wires are also used between the smart hub and indoor/outdoor units as well. When a thermostat cable with more than four wires is used, the extra wires must be properly connected to avoid electrical noise. The wires must not be left disconnected.

- Use wire nuts to bundle the unused wires at each end of the cable. A single wire should then be connected to the indoor unit end of the wire bundle and attached to the “C” terminals as shown in “Figure 3. Wire Termination in Communicating Systems (Electrical Noise) - Typical”.
- Keep all communication wiring as far away from the house electrical wiring and large electrical appliances as possible. Recommended minimal distance is 15 feet (4.6 meters).

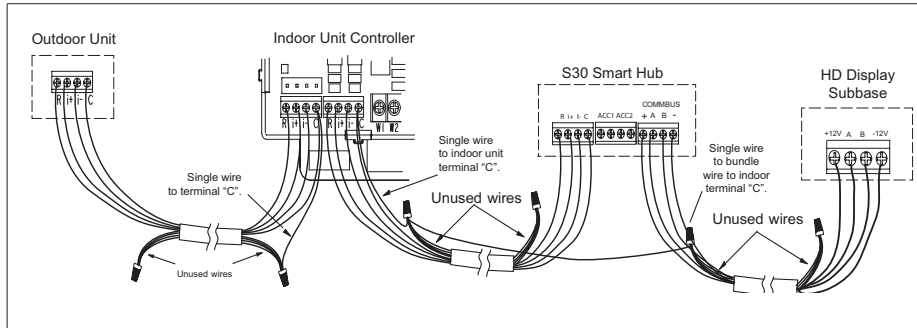

**Figure 3. Wire Termination in Communicating Systems (Electrical Noise) - Typical**

## Application Wiring

The following diagrams are typical low voltage wiring connections for various system configurations. When using an equipment interface module, see the wiring diagrams provided in 507240-xx, Equipment Interface Module (EIM) Installation and Setup Guide. The reference instruction is provided with the EIM.

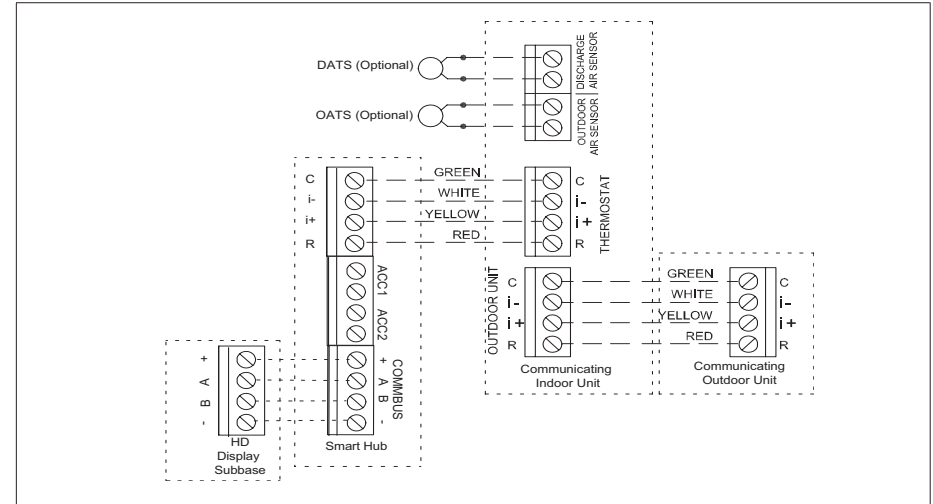

**Figure 4. iComfort S30 with Lennox Communicating Indoor and Outdoor Units**

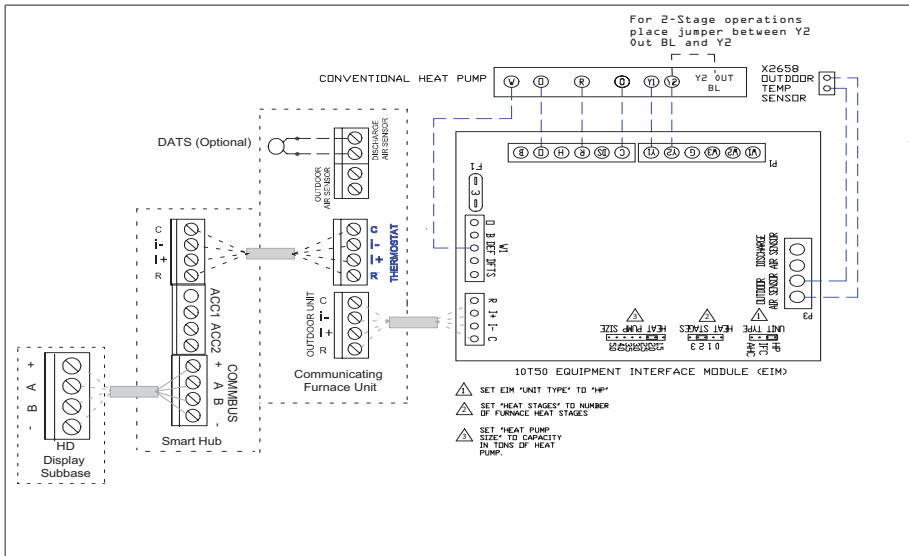

**Figure 5. iComfort S30 with Lennox Communicating Furnace with 24VAC (1- or 2-Stage) Heat Pump or Air Conditioner**

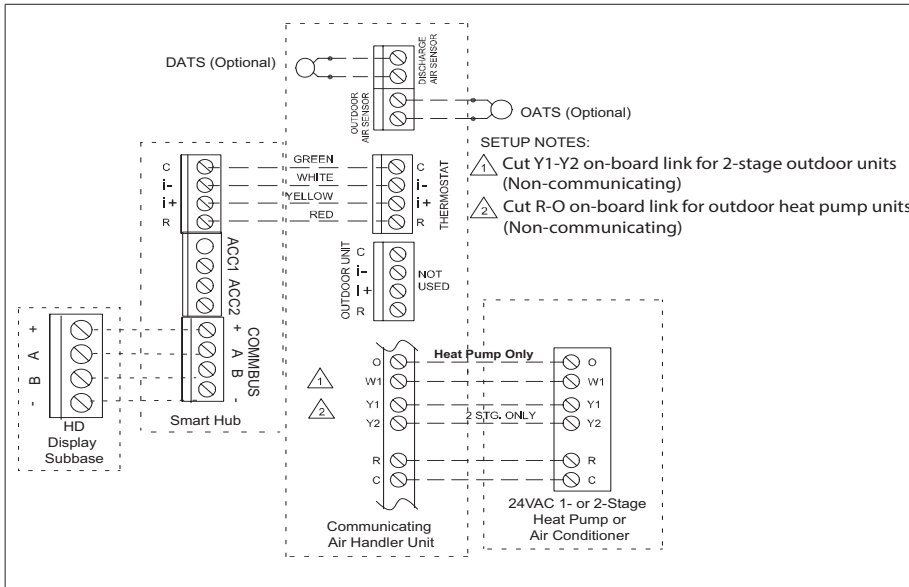

**Figure 6. iComfort S30, Lennox Communicating Air Handler with 24VAC (1- or 2-Stage) Heat Pump or Air Conditioner**

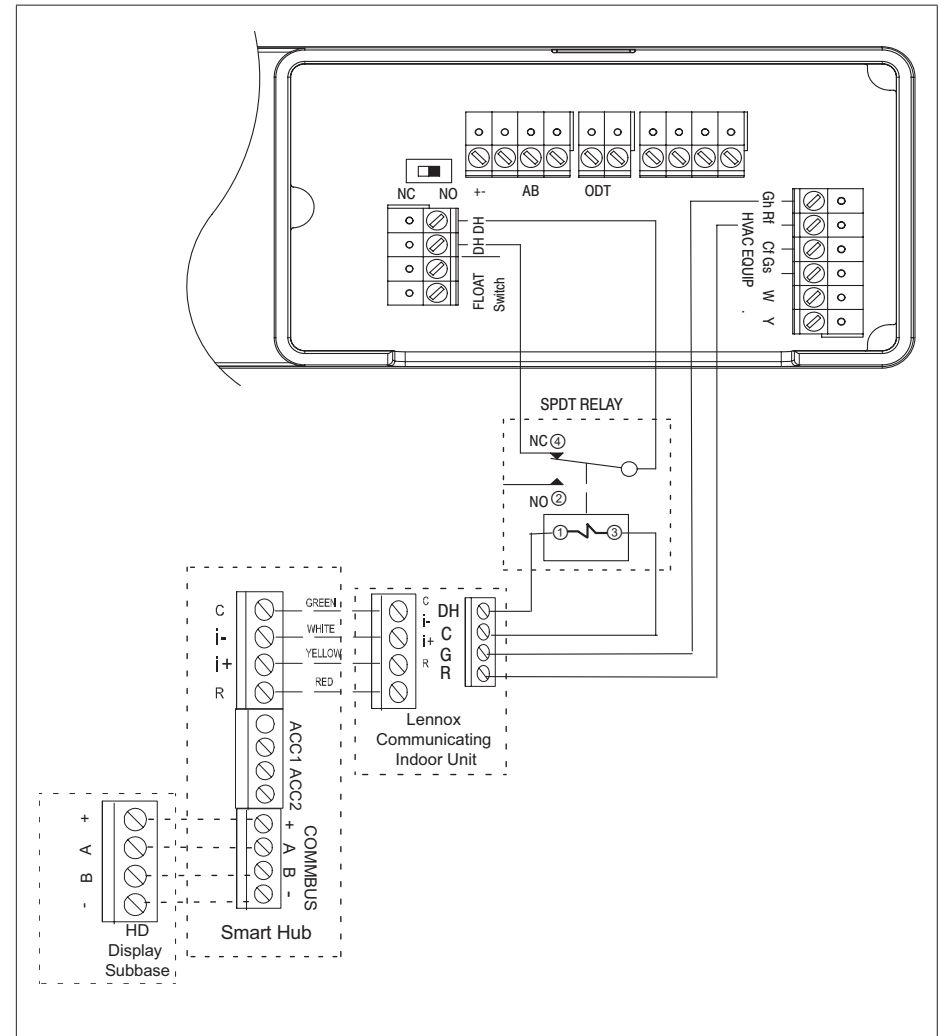

**Figure 7. iComfort S30, Communicating Indoor Unit (Conventional Connections), Relay and HCWHD3 Series Dehumidifiers**



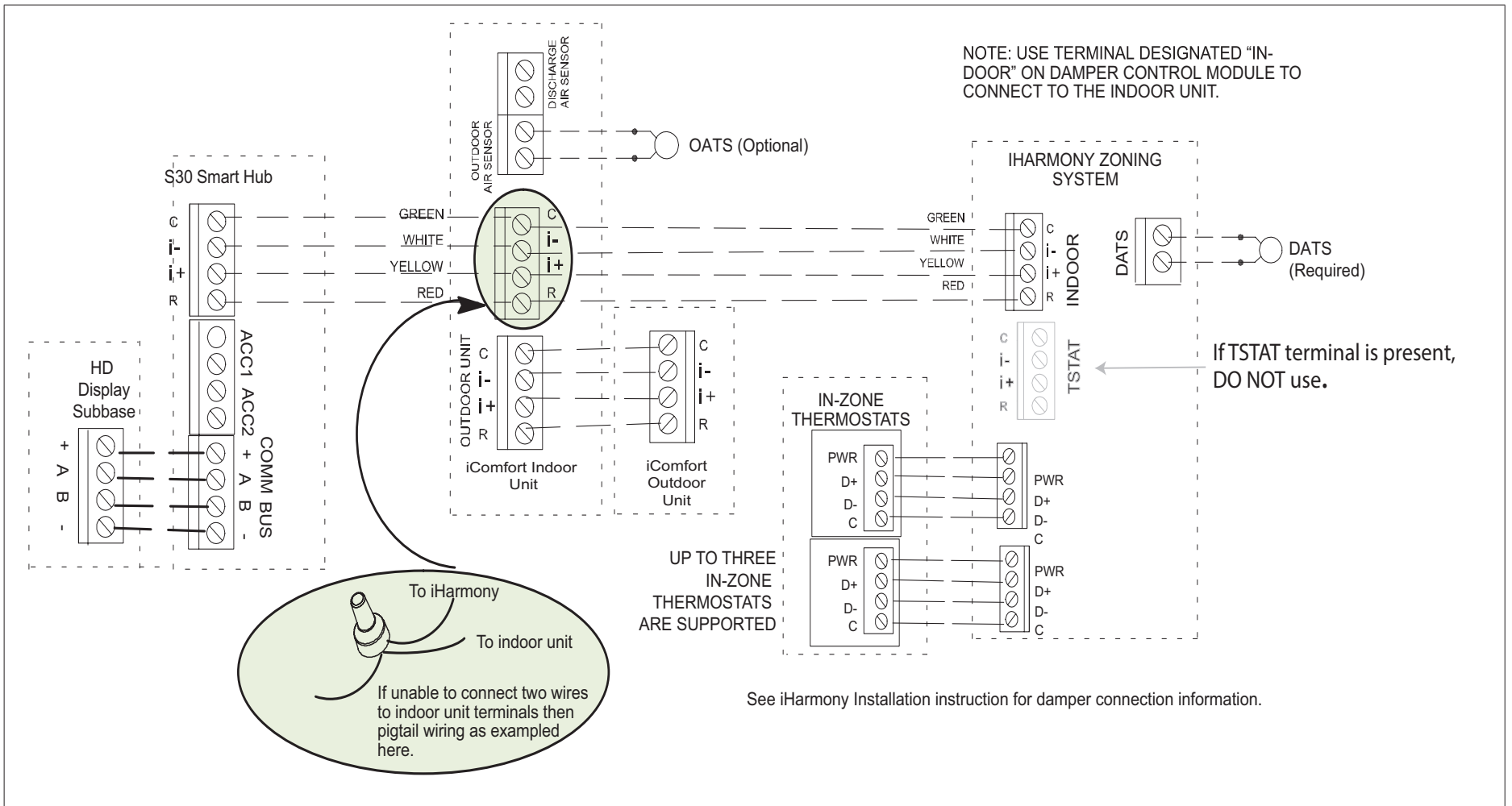

Figure 8. iComfort S30, Lennox Communicating Indoor and Outdoor Units, iHarmony Zoning System (Damper Control Module) and Zone Sensors

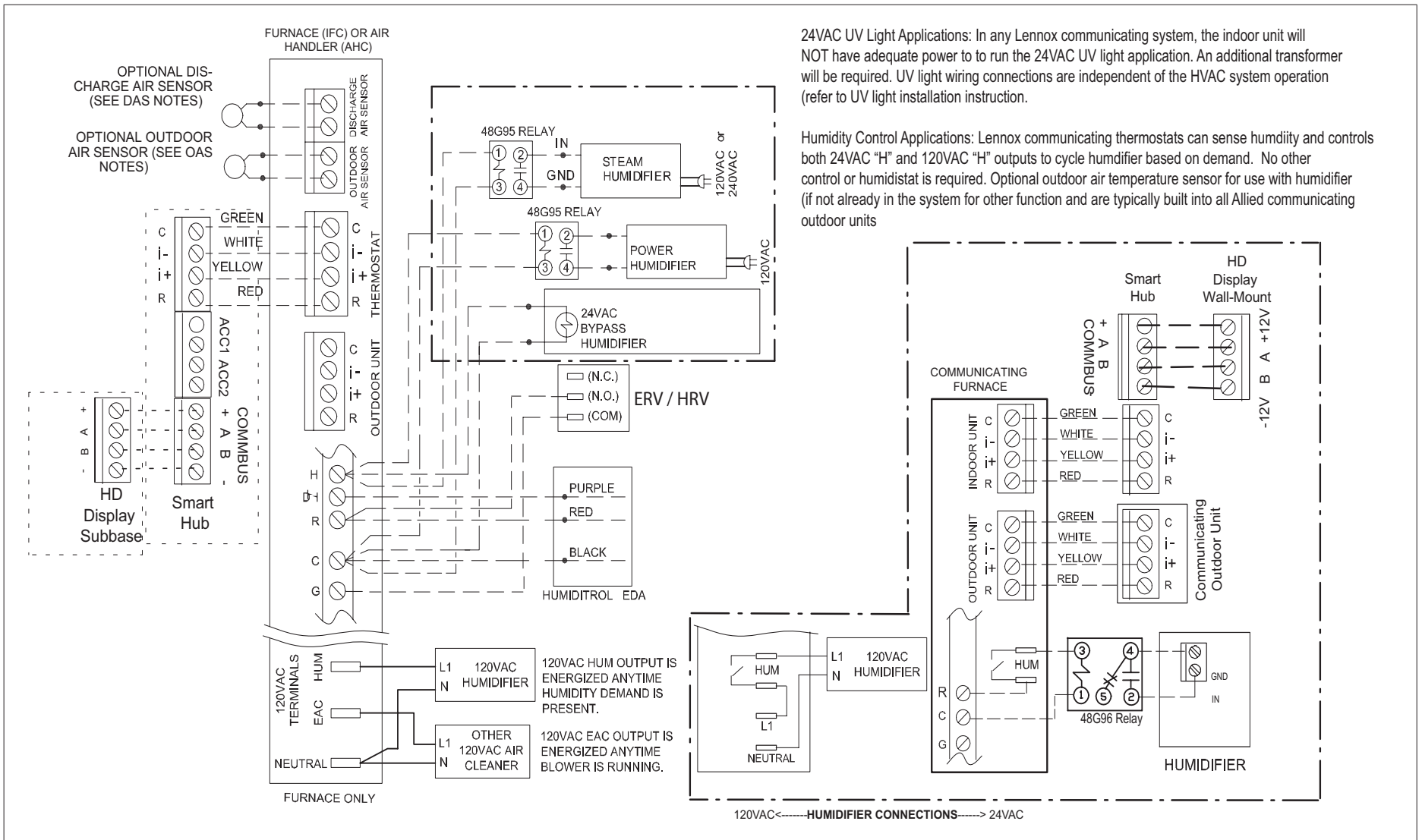
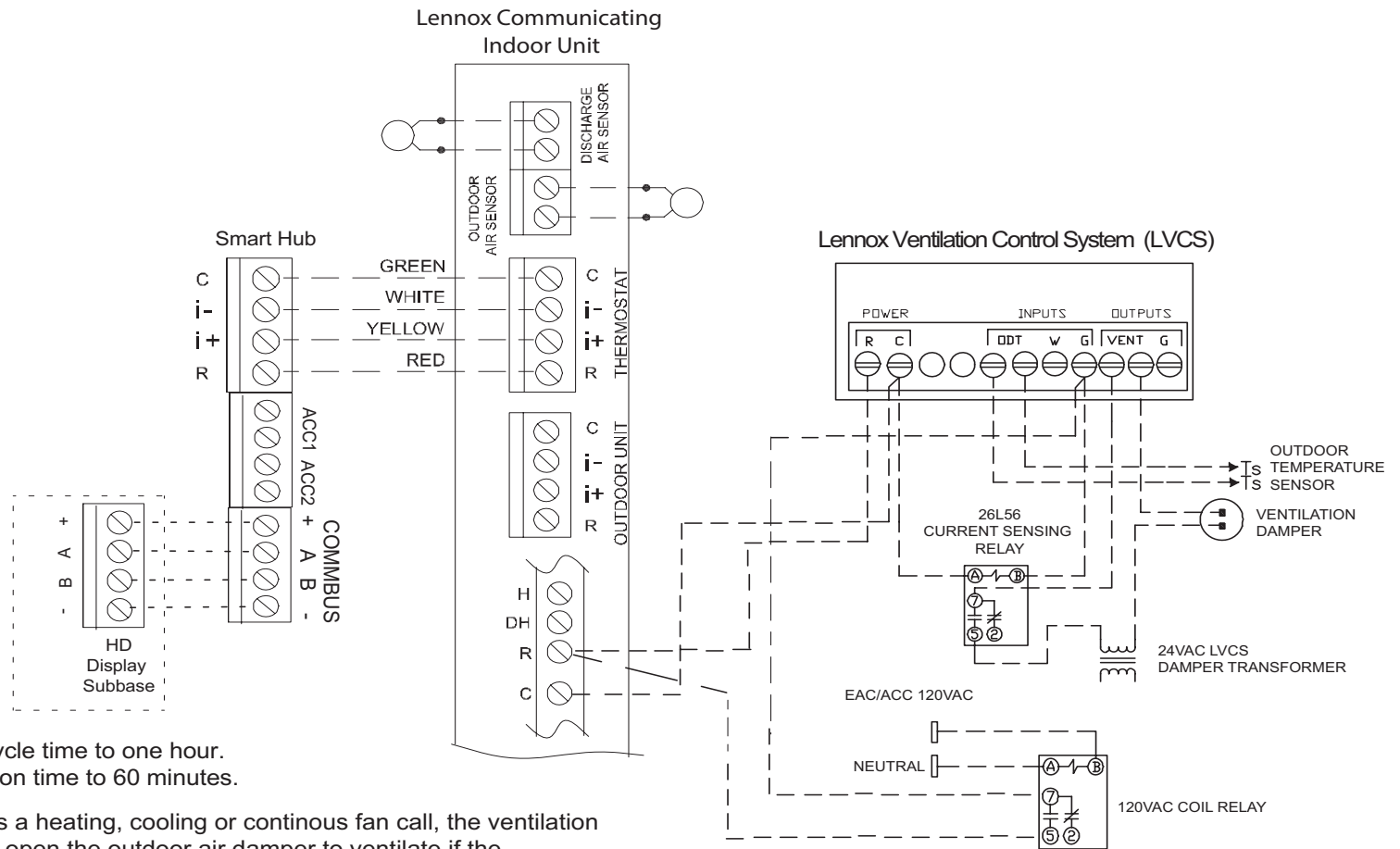

Figure 9. iComfort S30 with Humidifier Accessory



- Set LVCS cycle time to one hour.
- Set ventilation time to 60 minutes.

When there is a heating, cooling or continuous fan call, the ventilation controller will open the outdoor air damper to ventilate if the **outdoor temperature** and **indoor humidity** are within the limits of the ventilation controller.

**NOTE:** Pass the blower motor L1 wire through the current loop on the current sensing relay as illustrated.

**NOTE:** Set the communicating thermostat fan mode operation to **Circulate** and adjust duration to match control ventilation time duration.

Figure 10. iComfort S30, Lennox Ventilation Control System (LVCS), Current Sensing Relay, 120VAC Coil Relay, Damper Transformer, Ventilation Dampers and Communicating Indoor Unit (using Non-Communicating Terminals)

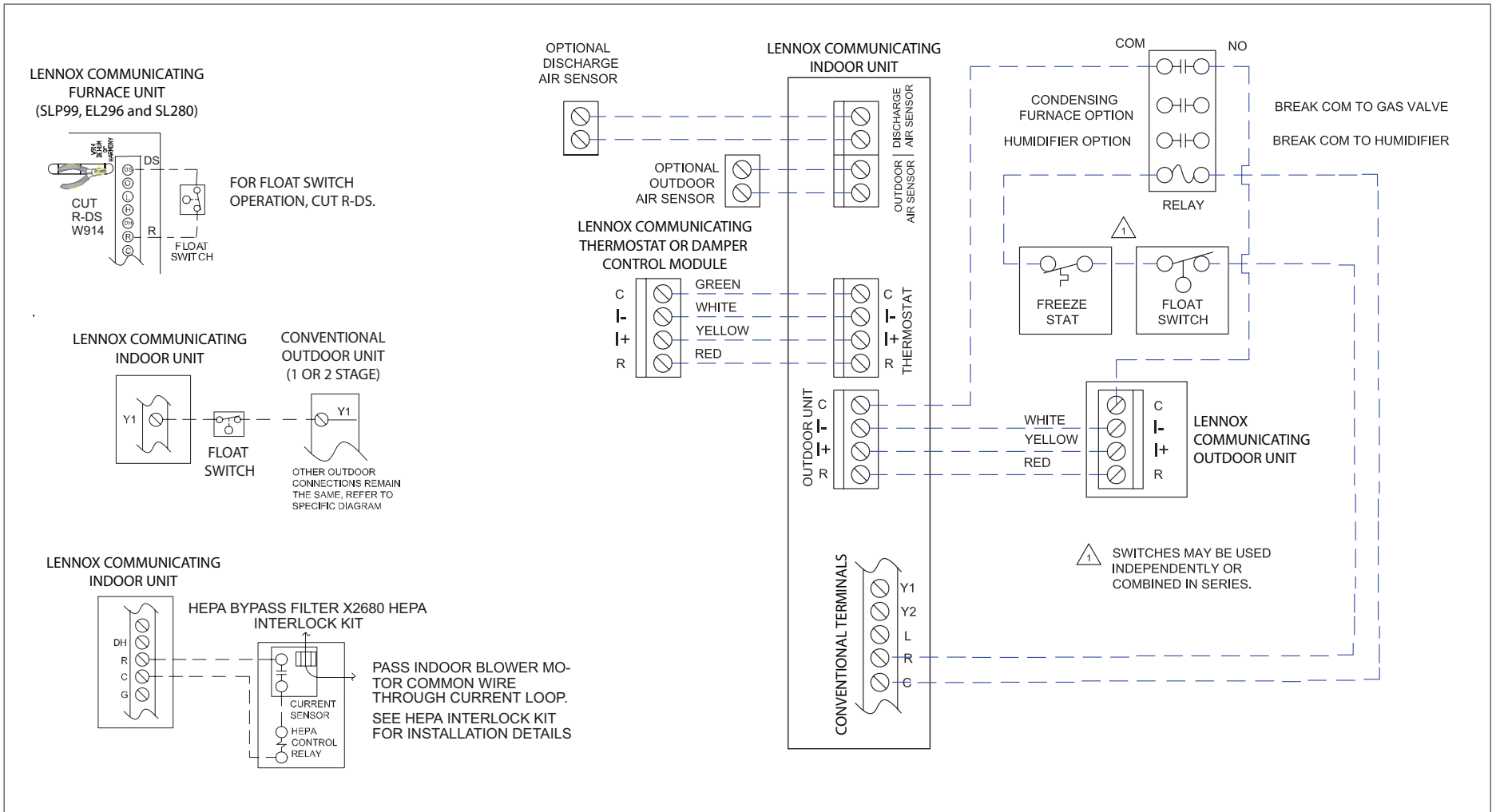

**Figure 11. Installing iComfort S30, Communicating Indoor Unit, Float Switch, HEPA Bypass Filter Interlock Kit, Humidifier, Relay and FreezeStat**

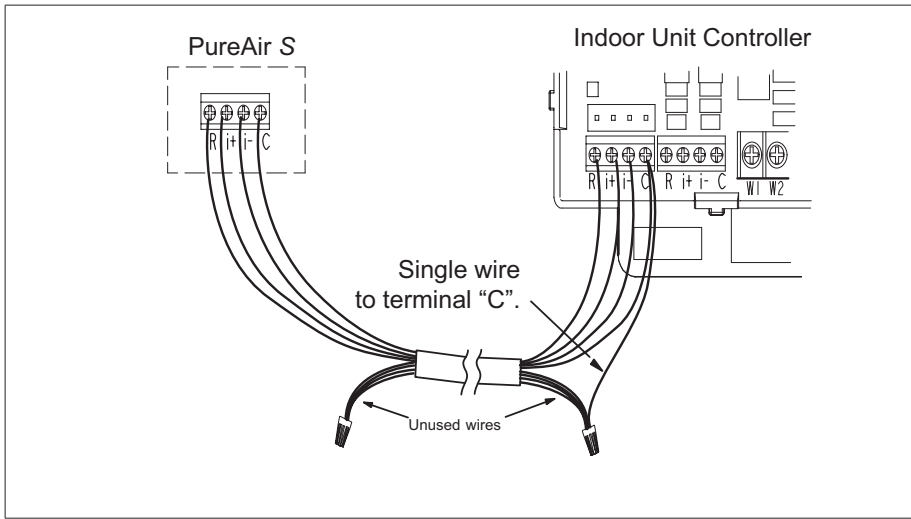

**Figure 12. Communicating Indoor Unit and PureAir S**

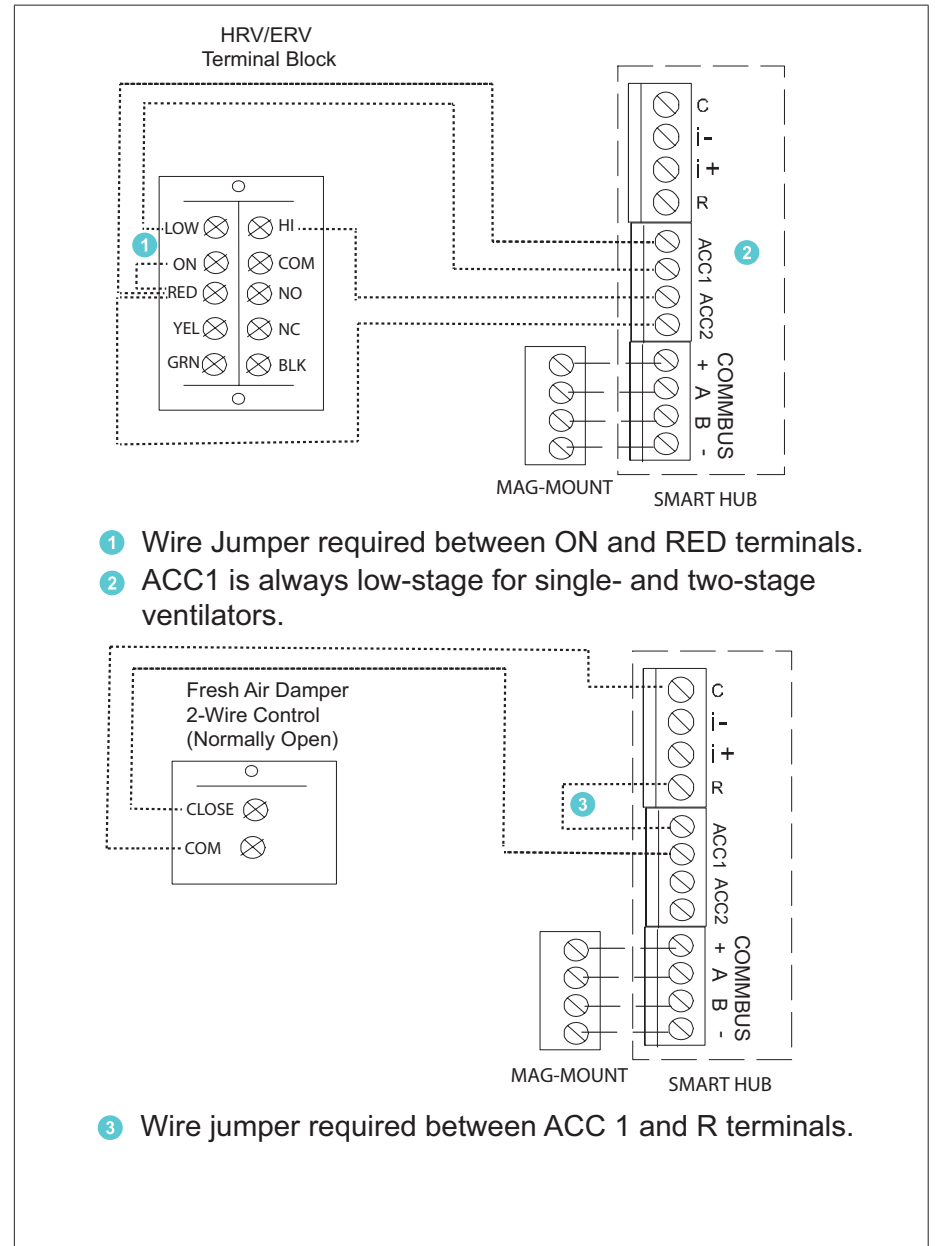

- ① Wire Jumper required between ON and RED terminals.
- ② ACC1 is always low-stage for single- and two-stage ventilators.

- ③ Wire jumper required between ACC 1 and R terminals.

**Figure 13. iComfort S30 with Ventilation (Fresh Air Damper, ERV and HRV)**

## Installation Recommendations

### ⚠ WARNING

Improper installation, adjustment, alteration, service or maintenance can cause property damage, personal injury or loss of life.

Installation and service must be performed by a licensed professional HVAC installer (or equivalent) or a service agency.

Before beginning installation, note the type of equipment, number of stages, and any accessories being installed.

#### Do

- Read this entire document, noting which procedures pertain to your specific equipment and system requirements.
- Make sure that all wiring conforms to local and national building and electrical codes and ordinances.

#### Do Not

- Install on voltages higher than 30VAC.
- Short (jumper) across terminals on the gas valve or at the system controls to test installation. This will damage the thermostat and void the warranty.
- Exceed 300 feet (91 meters) run when using 18AWG or 22AWG thermostat wire or larger (see “Table 5. Terminal Designations and Wiring Recommendations” on page 5 for further details).
- Allow power load from any thermostat connection to be more than 1 AMP

## Smart Hub Installation

### ⚠ IMPORTANT

Do not install smart hub in location where direct exposure to condensation or dripping water is possible.

**DO NOT** install smart hub on indoor unit.

1. Things to consider when installing the smart hub:
  - Install near the indoor unit such that there is a direct path to the approximate location of the home Wi-Fi access point (the signal is not blocked by the indoor unit or duct work, for example).
  - Can be attached to a vertical surface such as a wall stud or roof truss web, or to a horizontal surface such as a floor or ceiling joist, or a roof rafter.

- Smart hub antenna should be positioned such that it is roughly vertical, no matter the orientation of the smart hub, itself.
- Do not install the smart hub on the indoor unit, duct work, or other equipment that could induce vibration in the smart hub
- Do not install the smart hub on or near large metal objects. This could adversely affect the range and directional coverage of the smart hub Wi-Fi signal.
- If the smart hub **MUST** be installed on a metal object, orientate the antenna perpendicular to the metal surface.
- In all cases, the smart hub antenna orientation may need to be adjusted to obtain best Wi-Fi results.

2. Use the procedure outlined in “Figure 14. Smart Hub Installation” on page 14 to install the smart hub controller.

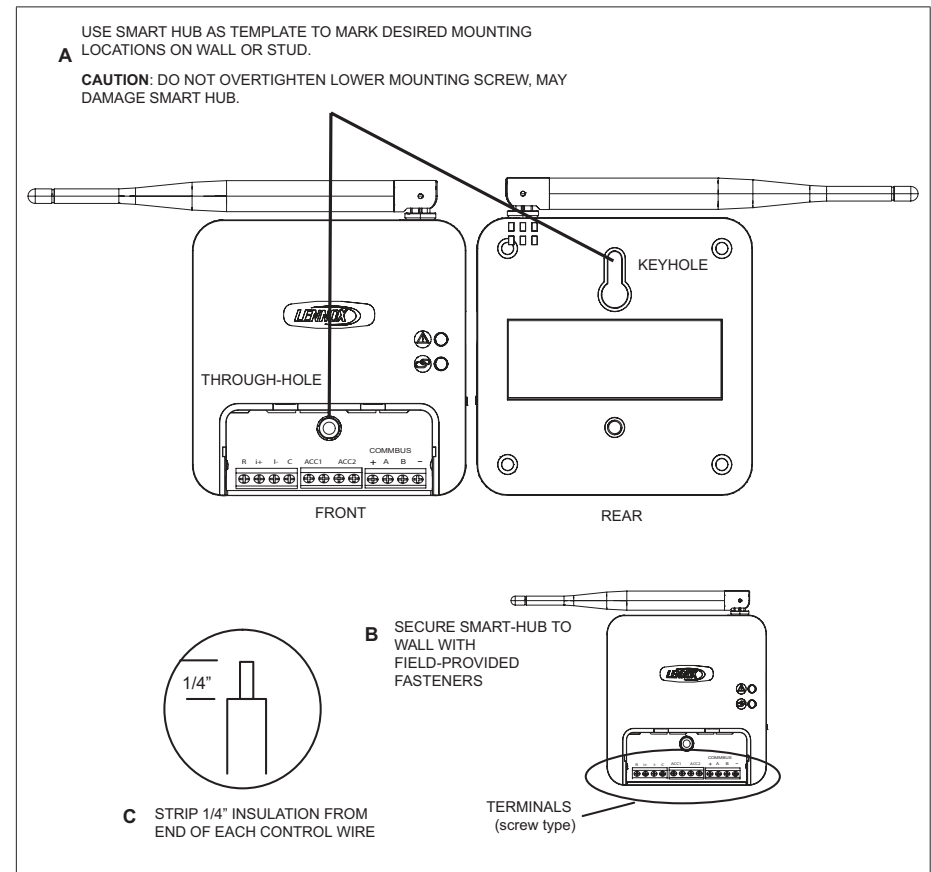

Figure 14. Smart Hub Installation

- For low voltage wiring connections use diagrams in section titled "Application Wiring" on page 7.

## HD Display Installation

### Installation

Use the following procedure for installation of the subbase where existing thermostat wiring does not exist:

- Unpack the HD Display and subbase.
- Detached subbase from HD Display body.

## ! IMPORTANT

Be careful not to bend the four connection pins protruding from the back side of the HD Display. **DO NOT** lay display down on side with pins. Damage pins could cause power and communication issues between the HD display and smart hub.

- Determine the best location to install subbase. Ideal location should be located away from outside wall, direct sunlight or discharge air vents.
- Cut or drill a small hole for thermostat wiring.

  
3/8" (10 mm)  
Diameter Hole

- Pull about three inches (75mm) of thermostat wire through the opening and remove the outer thermostat wire jacket.

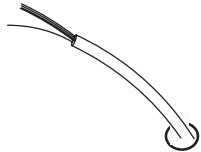

Seal wire hole in wall to prevent cold or hot air from affecting temperature sensor in display.

## ! IMPORTANT

Seal wire hole in wall to prevent cold or hot air from affecting temperature sensor in HD Display.

- Strip 1/4" (6 mm) insulation from end of each wire.



- Use a level to align the subbase or wall plate on wall horizontally.



- Use subbase as a template to mark the desired mounting hole locations on the wall.

**NOTE:** Make sure the UP arrow on the subbase is pointing up.

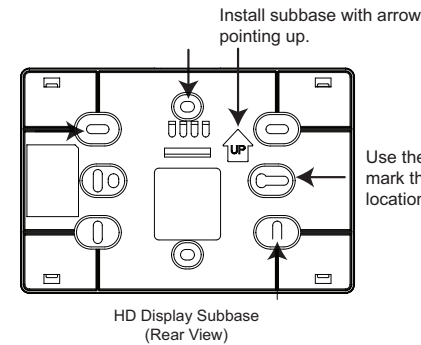

- Drill 3/16" (5 mm) holes at marked locations on the wall for anchors. Then insert wall anchors into holes until flush with the wall.

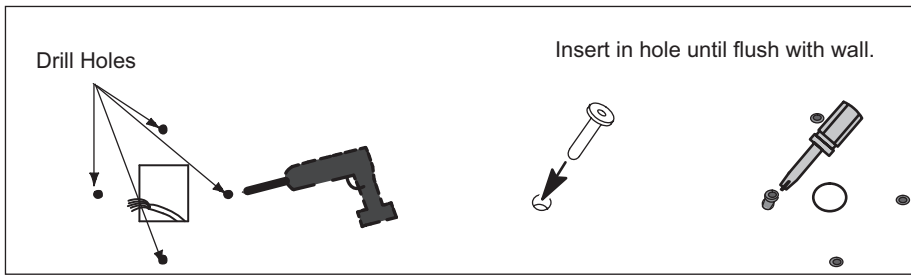

## ⚠ WARNING

**DO NOT** over-tighten mounting screws. Doing so may distort the subbase plastic housing and cause connection issues when installed the HD display.

10. Secure subbase with provided #6 x 1.25" pan-head screws (4).
11. Connect thermostat wiring to subbase screw terminals.

### Mounting Display to Subbase

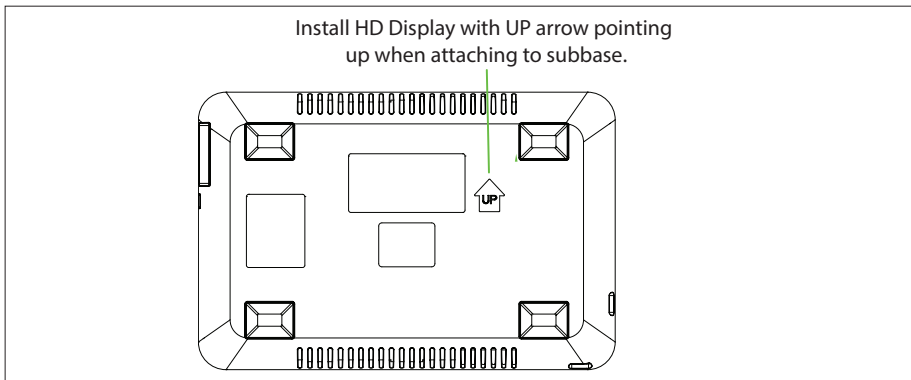

1. Hold the HD Display by the edges, line it up with the subbase (horizontal position), and move the HD Display toward the subbase.
2. Center the cavity on the back of the display over the subbase.
3. Gently press on the edges of the HD Display until you hear the mounting snaps engage. Be careful not to apply force directly on the glass.

**NOTE:** Once the HD Display is connected, it may take up to 45 seconds for it to power up.

4. To remove the HD Display from the subbase, grasp the left and right edges of the HD Display and gently pull towards yourself.

**NOTE:** If the HD Display is removed from the subbase, the HD Display will shut down and will not be able to communicate with the system. System can be controlled from mobile devices or consumer/dealer web portals once registration has been completed.

5. Do not remove the label covering the HD Display screen until after power is applied to the system.

## Lennox Communicating Air Handler Electric Heat Configuration

### Auto Detection

During the system initial commissioning, the electric heat strips are auto-detected and configured for the system. If electric heat is added after the system had already been configured, then go to **menu > settings > advanced settings > view dealer control center > equipment > reset > re-configure system** to auto-detect the new electric strips.

### Manual Configuration

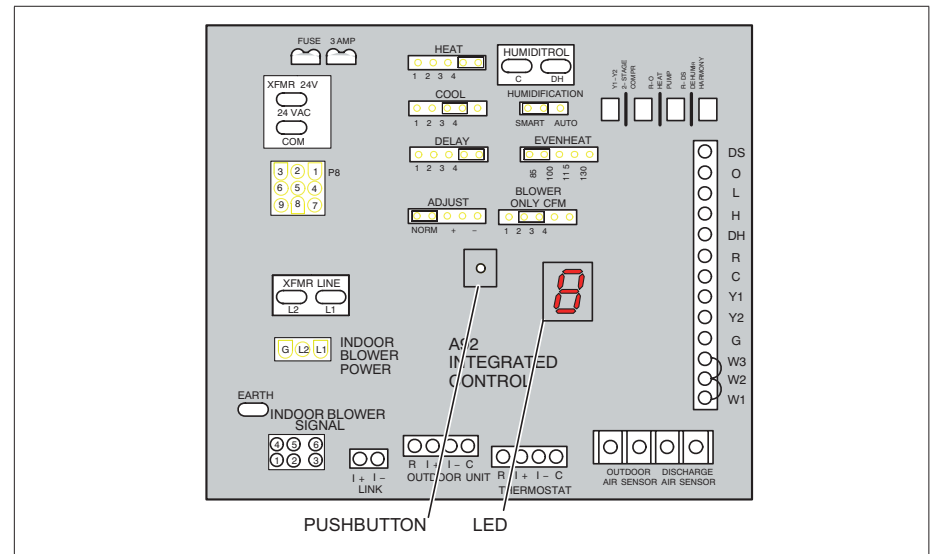

**Figure 15. Air Handler Control**

This procedure is applicable only to the CBX32MV-XX-230-6-06 and higher, CBA38MV and all CBX40UHV models. Use this procedure if for some reason the system is unable to auto-detect the electric heat strips:

- Power must be applied to the air handler but NOT to the smart hub.



- Disconnect any communication wiring between the smart hub and indoor unit prior to electric heat discovery.
  - The air handler control must be in idle mode (decimal blinks at 1 Hertz—0.5 second ON, 0.5 second OFF) to use the following procedure.
1. Select field test mode—press and hold the push button until solid “–” appears; release button. Display will blink.
  2. Push and hold button and wait for the display LED to show “H” (capital H), then release the button.
  3. The air handler control cycles the indoor blower motor “on” to the selected heat speed and stages the electric heat relays “on” and “off” to automatically detect the number of electric heat sections. The air handler control stores the number of electric heat sections, then automatically exits “Field Test Mode”.
  4. The thermostat will now detect the heat strip information stored in the air handler control.
  5. Turn off power and connect all low voltage wiring (power and communication to and from the smart hub).
  6. After completing the commissioning of the system then check to see if you have electric heat or emergency heat.

### Commissioning and Service (Using the Mobile Setup Application)

This application tool is used by dealers to commission a iComfort S30 ultra smart thermostat using a Wi-Fi enabled mobile device.

A temporary smart hub local network provides a means for a mobile device using the iComfort Mobile Setup application to directly communicate with the smart hub.

**NOTE:** *The iComfort Mobile Setup application running on a mobile device cannot connect to the smart hub through the Internet or home Wi-Fi network.*

To use the iComfort Mobile Setup app, the mobile device must be:

- Wi-Fi capable
- Located in the home near the smart hub

**NOTE:** *A router with Bonjour capabilities is required for this function. Check the router features if the smart hub does not connect. Apple Bonjour® is an implementation of Zero-configuration networking (Zeroconf), a group of technologies that includes service discovery, address assignment, and host name resolution.*

## Mobile Device Operating System Requirements

The iComfort Mobile Setup application is available for both IOS 6.0 and higher (App Store) and Android 4.1 and higher (Google Play).

## Establishing a Direct Wireless Connection to the Smart Hub

### IMPORTANT

If the connection between the iComfort Mobile Setup application and smart hub is idle for three (3) minutes, the smart hub will auto-disconnect from the mobile device. Repeat procedures to reconnect.

1. Download and install the iComfort Mobile Setup application.
2. Apply power to the system. The first screen to appear after boot-up is the Apple HomeKit commissioning screen. Cancel that screen for now.

**NOTE:** *At this point, it is recommended that when using the iComfort Mobile Setup application to commission the system, remove the HD Display from the subbase before starting.*

**NOTE:** *Once commissioning is completed you may reattach the HD Display to the subbase.*

3. Go to the smart hub and press the commissioning button located on the side of the unit (see “Figure 1. Smart Hub Indicators and External Components” on page 3 for location of button).
4. The commissioning status LED will start blinking green for two minutes. During this time the smart hub will broadcast its Wi-Fi identifier (SSID).
5. Go to your mobile device’s Wi-Fi connection tool and locate the smart hub Wi-Fi broadcast identifier. A typical example of a identifier (SSID) is DIRECT-XY12-3456.

**NOTE:** *Refer to your mobile device’s owners manual on how to use your Wi-Fi Connection tool.*

6. Connect to the smart hub by using the last eight digits of the smart hub SSID as the password. In this example, it would be XY123456).
7. Once the mobile device is connected to the smart hub, the commissioning Status LED will turn solid green.
8. Start the iComfort Mobile Setup application and make sure you are connected to the correct smart hub by checking the serial number.
9. Touch the **remote-in** tab on the iComfort Mobile Setup application home screen. This will take you to the commissioning screen.

10. You can use the information provided in “Commissioning (Using the HD Display)” on page 19 to complete the commissioning process using the iComfort Mobile Setup application.
11. If the system has not been commissioned it will go to commissioning screen automatically. If the system has already been commissioned it will go to dealer control center.
12. Once the commissioning is completed, exit the iComfort Mobile Setup application.
13. Go to the mobile device’s Wi-Fi tool and manually disconnect from the smart hub.
14. Once disconnected, the smart hub commissioning LED will change to solid blue.
15. Reinstall the HD Display on the subbase.

## Service

To use iComfort Mobile Setup application as a service tool, the commissioning of the system must have already been completed.

**NOTE:** *Currently there is a default timer for 30 minutes to complete any service procedures before the smart hub will automatically log you out. The duration of the timer cannot be adjusted.*

1. Download and install the iComfort Mobile Setup application if not already installed.
2. Go to the smart hub and press the commissioning button once.
3. The LED will start blinking green for two minutes. During this time the smart hub will broadcast its Wi-Fi identifier (SSID).
4. If this is the first time connecting to the target smart hub then go to your mobile device’s Wi-Fi connection tool and locate the smart hub Wi-Fi broadcast identifier. A typical example of a identifier (SSID) is DIRECT-XY12-3456.
5. If your mobile device had already connected previously to the target smart hub, then touch the applicable smart hub SSID on the list and skip to step 7.

**NOTE:** *Refer to your mobile device’s owners manual on how to use our Wi-Fi Connection tool.*

6. Connect to the smart hub by using the last eight digits of the smart hub SSID as the password (XY123456) for example.
7. Once connected to the mobile device the smart hub commissioning LED will turn solid green.
8. Start the iComfort Mobile Setup application and make sure you are connected to the correct smart hub by checking the serial number.

9. Touch the **remote-in** tab on the iComfort Mobile Setup application home screen.
10. If the system has not been commissioned it will launch the commissioning screen. If the system has already been commissioned it will go to dealer control center.
11. Once servicing is completed, exit the iComfort Mobile Setup application.
12. Go to the mobile device’s Wi-Fi tool and manually disconnect from the smart hub.
13. Once disconnected the smart hub LED will change to a solid blue.

## Alternative Method

From the home screen, go to **menu > settings > advanced settings > pair smart hub to iComfort dealer mobile app** selection. It will auto connect to dealer application and start you at the dealer control center screen. The following screen will appear and show the status of the connection. Once connected the screen will automatically disappear.

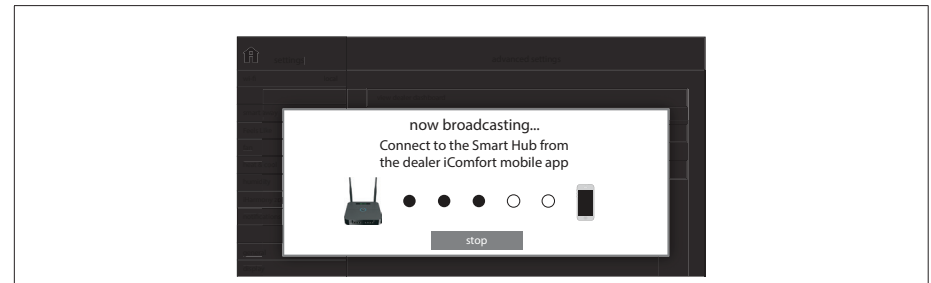

**Figure 16. Pairing**

## MULTIPLE SMART HUB(S) - GROUP ID

Multiple smart hubs in a home can be assigned to a group (up to nine groups with up to five (5) smart hubs in each group). All smart hubs in a group can communicate with other smart hubs in the same group over the home Wi-Fi network.

Default Group ID 1. Range is 1 to 9.

**NOTE:** *If a smart hub is set to Group 0, then there is no connectivity with another smart hub.*

Group IDs can be changed by going to **menu > settings > advanced settings > view > dealer control center > equipment > smart hub**.

## Restarting smart hub

Pressing the smart hub button for more than five seconds will reboot the smart hub.

## Commissioning (Using the HD Display)

The following procedures are written for commissioning the system using the HD display interface. When power is first applied to the system all communicating devices attached to the system (air handler or furnace, outdoor unit, PureAir S or zoning control) will automatically be configured using optimal factory default settings based on system type, capacity and other configuration considerations.

**NOTE:** If there is an PureAir S air purification system installed, during commissioning the blower will turn on and run at three different CFM settings for the PCO filter calibration to take place. This may be well in advanced before the display is fully up and running. This is a normal process. The blower may run as long as ninety (90) seconds at each CFM setting to complete the filter calibration.

### BOOT-UP SCREEN

When power is applied to the system, the HD Display will display a welcome screen. If there is an issue with communication between the HD Display and smart hub, a critical alert message will appear on the screen. The alert message will provide detail information concerning the possible cause. Once the issue is corrected and power is restored to the system the first screen in the initial commissioning sequence will appear.

## ! IMPORTANT

Sometimes there is a communication delay between the HD Display and smart hub during initial boot-up which will result in the reference message being display. Please wait up to one minute to see if the communication delay is resolved.

Below is an example of a communication error message.



Figure 17. Communication Error Message Example

If the system cannot resolve the communication issue, check all connections between the smart hub and HD Display subbase. Also ensure HD Display is correctly mounted to subbase.

## Apple HomeKit Wi-Fi Accessory Configuration

A pop-up screen will appear providing instructions on how to connect the thermostat to the home Wi-Fi network using an Apple IOS device. If you wish to use this method to configure the unit for Wi-Fi and Apple HomeKit, then refer to the provided user guide for additional instructions.

Otherwise, select cancel to proceed with the thermostat commissioning procedures. There is an option to perform this task later on at the homeowners convenience.

**NOTE:** This procedure can only be accomplished using a Apple IOS device.

### Dealer Info

## ! IMPORTANT

The thermostat is only accessible via the Dealer Dashboard after the dealership's main phone number or company name is added during thermostat commissioning. See "LennoxPros Dealer Dashboard" on page 95 for further details.

This screen in the commissioning sequence is the dealer information screen where the dealer ID and/or phone number can be added. Once the system is connected to the Internet, the remaining information will be populated automatically by the Lennox server based on the dealer name or phone number entered. All information can be entered manually if desired however.

Information that can be manually entered is name, email website, dealer address which includes address 1, address 2, city, state and zip/postal code. Once completed touch continue.

### Dealer Info Notification Pop-Up Screen

If either the **Dealer ID** or **phone number** is NOT provided, a notification screen will appear. The notification screen will provide information on the limitation imposed on the system if this information is not provided. Touch **no** to return to the previous screen to complete the information requested or touch **yes** to continue.

### General Information

On this screen general information needs to be verified or changed. Touch any item to change its contents. A pop-up screen will appear that will allow the information to be added or changed.

1. Select desired language (ENGLISH, FRANÇAIS or ESPAÑOL).
2. Select **country / region**.

3. Select **time** and **date** which includes time, date, time zone and daylight savings time (ON/OFF).
4. Select **temperature unit** (Fahrenheit or Celsius).
5. Once completed touch **continue**.

## Equipment Found Screen

---

### Communicating Equipment Found

This screen will display any communicating equipment the system has detected (air handler, furnace, outdoor unit, PureAir S, smart hub and iHarmony zoning system during initial commissioning of the system.

**NOTE:** When a Lennox Equipment Interface Module (EIM) is used and configured as either a furnace or air handler, then the component would appear as either EIM-Furnace or EIM-Air Handler. When using a EIM the outdoor unit may be either a Lennox communicating or any standard 24VAC non-communicating unit.

**NOTE:** Not all equipment may be visible from the equipment found system screen. Touch and swipe up to access additional information (if applicable) listed at the bottom of the system box.

If non-communicating equipment needs to be added, it can be done so from this screen.

### Adding Non-Communicating Equipment

When selecting the non-communicating (24VAC) equipment icon a screen will appear listing equipment that can be added. When selecting an applicable component, a green check will appear next to the item. The capacity selection of the outdoor unit will also be displayed on the screen after selecting the applicable outdoor equipment type.

**NOTE:** A temporary dialog box will appear indicating: Updating - Wait while we check for dependencies.

**NOTE:** Selecting an outdoor unit type only appears if a communicating outdoor unit is not detected by the system. Selections are one or two-stage heat pumps or air conditioners. Outdoor unit capacity will also have to be set. Other non-communicating equipment that can be added are:

- » Humidifiers
- » Dehumidifiers
- » Humiditrol (not compatible with Lennox Variable Capacity Outdoor Units)
- » Auxiliary Dehumidifier
- » Fresh Air Damper

- » 1 or 2 Speed ERV (energy recovery ventilation)
- » 2 or 2 Speed HRV (heat recovery ventilation)

Once completed touch **done** which will display the equipment found screen. There the additional non-communicating equipment will now be displayed along with the iComfort equipment. Once completed touch **continue**.

## Reminders

---

This screen allows you to set reminders as either disabled or 3, 6, 12 or 24 months and also custom by specific date. The other options on this screen is to trigger the reminder event either by calendar or actual system run-time.

Reminders may be set for Replace filter 1, Replace filter 2, Replace UV bulb, Replace humidifier pad, PureAir™ maintenance, Maintenance reminder, Ventilation maintenance and Ventilation filter.

Once a reminder is set for a specific item, touch done to return to the previous screen. An “expires on date” will appear next to the item just set.

## iHarmony Zoning

---

This screen will only appear if the iHarmony® zoning system is detected. This screen allows you to rename each zone. You may use the preset names or any custom name you may desire. If zoning is not applicable, proceed to the next section.

1. Touch on any zone to rename it. A screen will display that list several predefined names that can be used which are master bedroom, guest bedroom, kitchen, living room, media room, dining room, library or custom. When a predefine name is selected, a green check-mark will appear next to the selected name.
2. When creating a custom name, touch custom, enter a name and touch back to return to the previous screen. A new unique zone name can be created for all four zones.
3. When completed, touch done to return to the zoning screen and verify the new name is being used for the specific zone.
4. Once completed touch **continue**.

### SET UP AIRFLOW PER ZONE

This screen will allow the installer to setup the airflow per zone. The types of circulation per zone are:

- Blower Circulation Airflow (gray) which includes total, assigned, minimum and maximum airflow.
- Heating Circulation Airflow (red) which includes total, assigned, minimum and maximum airflow.

- Cooling Circulation Airflow (blue) which includes total, assigned, minimum and maximum airflow.

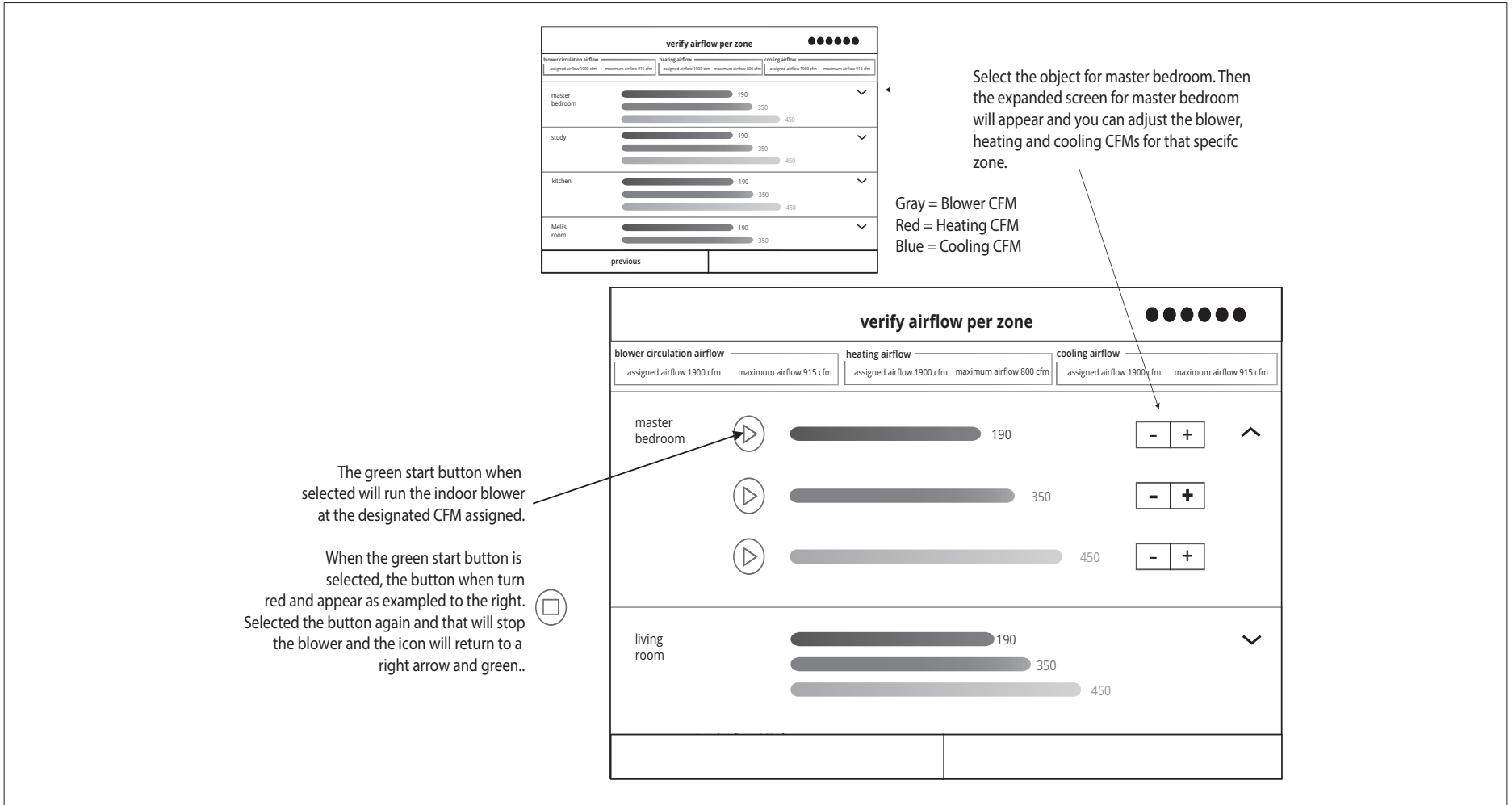

**Figure 18. Verify Airflow Per Zone Screen**

1. Touch on the circled green arrow to touch a specific zone. The that zone settings will expand to allow the installer to adjust CFMs for each circulation airflow type. Use the plus and minus buttons to adjust CFMs up and down.
2. Once completed touch to **continue**. The next screen that will appear is the Dealer Control Center.

### Commissioning Completion

Once commissioning is completed, the system will leave you at the **Dealer Control Center**. You can either touch exit to go to the main screen or perform any function listed in the various categories displayed.

## Dealer Control Center

This menu provides access for the installer or service technician to perform various functions. Advance equipment configurations, notifications, tests, diagnostics, installation reports and general information about the system.

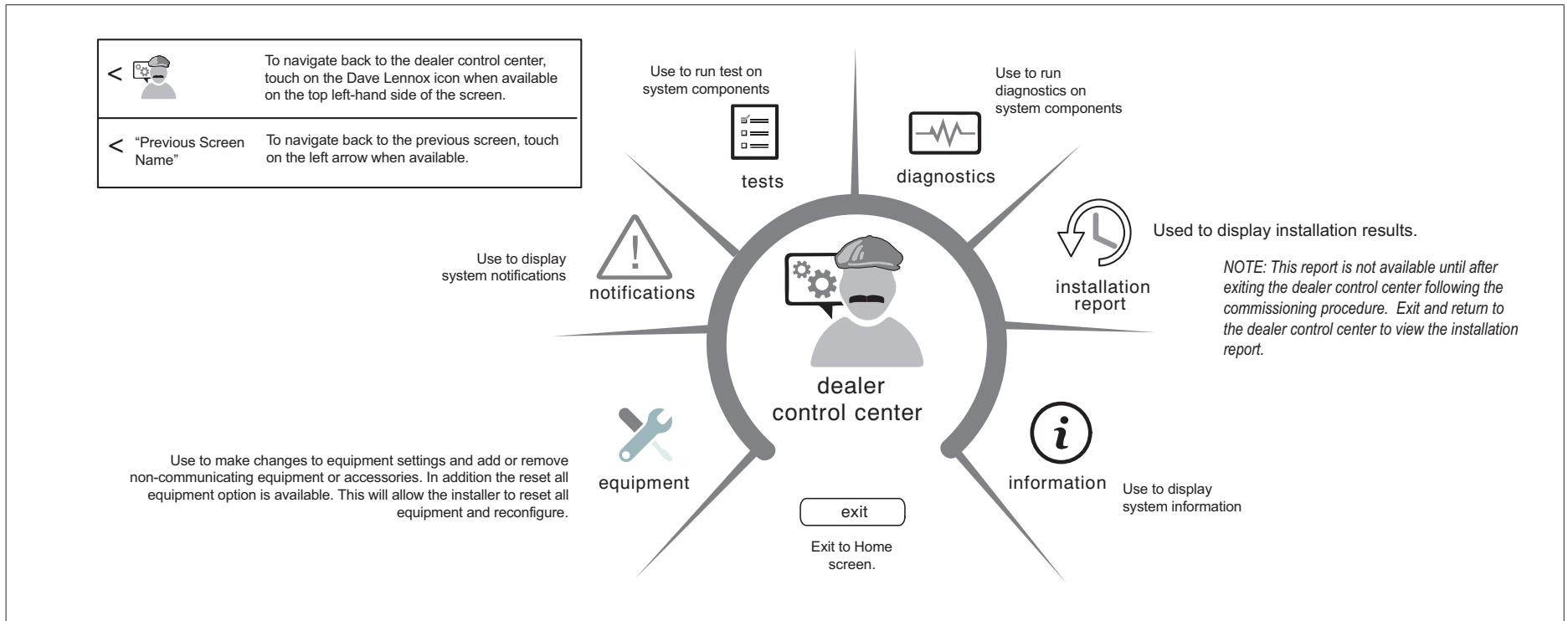

Figure 19. Dealer Control Center

## Equipment Parameters

Selections listed in this section are dependent on system hardware configuration. Not all options listed in this section will be available.

**NOTE:** When changing the default settings for any parameter, there is a possibility that it will affect the settings for another parameter. If this happens, a pop-up message will be displayed listing the other affected parameters and their new automatically set values.

The following is a complete list of all possible parameters listed under **System**. Parameters actually available are dependent on the Lennox communicating equipment type detected and non-communicating equipment added.

**Table 6. Smart Hub Parameters**

Parameter (In alphabetical order)	Description
<b>About</b>	This screen provides information concerning language supported, equipment type name, control software revision, model, control mode number, control serial number, control hardware revision, protocol revision number, device product level, 24VAC average power consumption, 24VAC peak power consumption, compatible devices list, application code memory size and micro-controller part number.
<b>Auto Changeover - Humidif. Deadband</b>	Prevents the humidification and dehumidification settings from being closer together than 5% or greater than 10% (Dead-band). Range is 5 to 10%. Default is 5%. Adjustments are in increments of 1%.
<b>Auto Changeover - Temp Deadband</b>	Prevents the heating and cooling from being set closer together than 3°F (1.67°C) or greater than 9°F (5.0°C) (Dead- band). Range is 3 to 9°F (1.67 to 5.0°C). Default is 3°F (1.67°C). Adjustments are in increments of 1°F (0.56°C).
<b>Auto Dehumidification Overcooling Threshold</b>	Adjustments are in increments of 1%. This value can automatically be affected by adjusting other parameters. One example would be when enabling Max Dehumidification Overcooling. Range is 0 - 10%. Default is 4%.
<b>Aux Heating Activation Threshold</b>	<p>This is an adjustment to hasten or delay the aux heat activation. This adjusts how far below the set point the temperature must fall with the HP at 100% before allowing electric heat to come on. Range is 0 - 10°F (0.0 to 5.56°C) with increments of 0.25°F (0.14°C). The default setting is 2.5°F (0.83°C).</p> <p><b>Definition/Dependencies:</b></p> <p style="text-align: center;"><b>Step Change versus Steady State Modes</b></p> <ul style="list-style-type: none"> <li>• Outdoor temperature below the high balance point or with balance points disabled.</li> <li>• Heat Pump demand above 95% for 10 minutes.</li> <li>• Sixty (60) minute temperature rise prediction = less than this Parameter Setting (value)</li> </ul> <p><b>Result:</b> The Heating Proportional Integral Algorithm (as set for less, normal, or more aggressive) will begin to stage on the electric heat to bring the space temperature up to set point.</p> <p><b>Synopsis:</b> The lower this parameter is set, the quicker the auxiliary heating will respond, in both step change mode and steady state mode.</p>
<b>Balance Point Control</b>	
<p>If system is set up as dual fuel or heat pump with electric heat and a outdoor temperature sensor connected to smart hub, the low and high balance point settings will appear. The balance points feature requires that a sensed outdoor temperature is provided to the thermostat. The outdoor ambient temperature can be read from either a:</p> <ul style="list-style-type: none"> <li>• Field-installed outdoor temperature sensor (X2658).</li> <li>• Communicating heat pump. All communicating heat pumps have a factory-installed outdoor temperature sensor.</li> </ul> <p>Options are enabled or disabled. Default is disabled. When enabled, both low and high balance points can be set.</p>	
<b>High Balance Point</b>	This setting is used to prevent the furnace or electric heat from heating the structure. (Alert 19 - Minor - Notification only - The outdoor temperature is higher than the level where the furnace or electric heat is programmed to heat the home.) Range is -17 to 75°F (-27.22 to 23.89°C). Default is 50°F (10.0°C). Adjustments are in increments of 1°F (0.56°C).

**Table 6. Smart Hub Parameters**

Parameter (In alphabetical order)	Description
<b>Low Balance Point</b>	<p>Setting used to prevent the heat pump from heating the structure. (Alert 18 - Minor - Notification only - The outdoor temperature is below the level where the heat pump is programmed to heat the home).                      Range is -20 to 72°F (-28.89 to 22.22°C). Default is 25°F (-3.89°C). Adjustments are in increments of 1°F (0.56°C).</p> <p><b>NOTE:</b> <i>Dual-Fuel Applications (Communicating Systems Only) - Dual fuel applications, which include both a Heat Pump and a gas furnace, will provide multiple stages of heating. For example, a two-stage heat pump would deliver two stages of heat. The gas furnace can add two to four more stages of heat.</i></p>
<b>CFA Cooling Discomfort Threshold</b>	<p>Default is ON. The purpose of this algorithm when set to ON is to detect systems with faults which are causing measurable loss of comfort and thus, need repair/service intervention.                      The algorithm monitors the duration in which the indoor temperature is above the cool set point or below the heat set point and does not approach the set-point. When an issue is detected alarm 901 is activated.</p>
<b>Cooling Capacity Alert</b>	<p>Options are ON or OFF. Default is ON. Cooling operation may not be sufficient for the hottest days. Based on local conditions and climatological data for zip code. Examples: Dirty Filter, Low Freon charge, TXV, etc. Symptom during mild temperatures may include; system running longer than normal but not showing any other symptoms.</p>
<b>Cooling Mode</b>	<p>Options are Normal and Comfort. Default is Normal. When changing to Comfort Mode, several parameters are automatically modified for optimal system operations. The changed parameters are listed on the screen when set to Comfort.</p> <ul style="list-style-type: none"> <li>• Normal - This setting cools the home to the desired temperature setting. Once second-stage is activated by timer or differential, it will not stage down to first-stage until the next cooling cycle demand.</li> <li>• Comfort - This is when the system could automatically stage up or down based on the current load demand.</li> </ul>
<b>Cooling Prognostics</b>	<p>This algorithm will determine whether the unit will run out of capacity during the hottest time of summer. It will look back everyday a minimum of three days to see if there is a pattern and compare it to the hottest day on record for that zip code before triggering an notification. It must see a pattern before it will trigger the notification. There may be a component or components that will require attention.                      The sensitivity (threshold) selection options are <b>OFF</b>, <b>LOW</b>, <b>MEDIUM</b>, and <b>HIGH</b>. The default is <b>HIGH</b>. The alert code notification is 65545.</p>
<b>DAT Integral Gain</b> (Lennox Variable Capacity Outdoor Units)	<p>The indicates how stable the system is attempting to reach the discharge air temperature set point. You may hear the compressor hunting (ramping up and down) adjusting to lower setting will correct.                      Lennox advises not to make changes to this setting without first contacting Lennox technical support or Lennox field technical consultant.                      Default is 3.0. Range is 1.0 to 15.0 in increments of 0.5.</p>
<b>DAT Offset</b>	<p>This parameter is only available when a Lennox variable capacity outdoor units is installed along with a discharge air temperature sensor (DATS) Installed is used.                      Default is 0.0°F (0.0°C). Range is -5.0°F to 5.0°F (-2.88 to 2.78°C) in increments of 0.5°F (0.28°C).</p>
<b>DAT Proportional Gain</b> (Lennox Variable Capacity Outdoor Units)	<p>This is how the system attempts to reach the discharge air temperature set point.                      Lennox advises not to make changes to this setting without first contacting Lennox technical support or Lennox field technical consultant.                      Default is 3.0. Range is 1.0 to 15.0 in increments of 0.5.</p>
<b>Dew Point Adjustment</b>	<p>The Dew Point Adjustment can be set from -15% to +15%. These settings allow adjustments to the Dew Point setting for the home. Some homes may require an adjustment to help maintain comfort. If condensation is present on windows, set the adjustment lower, between -15% to -5%. If the home feels dry, set the adjustment upwards, between +5 to +15%.</p> <p><b>NOTE:</b> <i>Dew Point - Adjustment requires an outdoor air (temperature) sensor (OATS) (X2658) and is automatically controlled by the outside temperature.</i></p>
<b>Electric Heat Control Mode</b> (Single and Two-Stage Lennox Communicating Outdoor Units Only)	<p>In heat pump applications, the electric heat is staged to provide supplemental heat to meet desired comfort levels. When the electric heat section is used in applications that do not have a heat pump, the elements are staged to limit heat so that it meets heating demands only.                      Options are Standard and EvenHeat. Default is Standard.</p>



**Table 6. Smart Hub Parameters**

Parameter (In alphabetical order)	Description
<b>Electric Heat Stages During Defrost</b>	Can increase or decrease the number of electric elements to come on during a call for defrost. (Thermostat will have a demand for heat.) Range is 0 to 5 electric heat stages. Default is 2. Adjustments are in increments of 1. <b>NOTE:</b> <i>Selecting 0 will not allow any electric heat stages during defrost.</i>
<b>Electric Heating Activation Hold Time</b>	This parameter represents the amount of time the system waits to check the slope of the temperature against the value in “Aux Heating Activation Threshold” parameter. It checks the room temperature slope after a time to determine if aux heat is needed to achieve a new room temperature set point) to allow the heating PI to accumulate past 100 (up to 200) which allows electric auxiliary heat use. Range is 0~60 minutes with a default of 10 minutes. Increments are in 5 minute intervals.
<b>Electric Heating Activation Temp Difference</b>	When the system is operating at full heat pump demand, this is the amount of °F (°C) below the set point that is allowed before allowing the use of Aux heat to supplement the heat pump. This parameter is only available when the system is configured with an air handler and modulating heat pump. Range is 0.5 - 10°F. Default 1.5°F. Increment of 0.5°F.
<b>Equipment Name</b>	A unique name can be assigned to this component. Name can be up to 29 characters. Name can consist of letters, numbers, special characters and spaces. Default name is subnet controller.
<b>EvenHeat Discharge Temp</b>	When in EvenHeat Control Mode, the thermostat will stage the electric heat sections to maintain a constant discharge air temperature. The system must have a DATS connected to the system to show this parameter. <b>NOTE:</b> <i>Not selectable on Lennox variable capacity outdoor units. Electric heat elements will be staged on by the demand of the thermostat.</i> Range is 85 to 130°F (29.4 to 54.4°C). Default is 85°F (29.4°C). Adjustments can be made in increments of 15°F (8.4°C) .
<b>Gas Heat Control Mode</b> (SLP98V only)	Options are Staged, Load Tracking Variable Capacity and Variable Capacity. Default is Load Tracking Variable Capacity <b>Staged:</b> Some furnaces can be configured to provide up to four stages of gas heat operation. When staged heating is chosen, the iComfort thermostat allows you to choose between 1, 2, 3 and 4 stages of heat. Single-stage heat: first stage provides 100% of full capacity. <ul style="list-style-type: none"> <li>• Two-stage heat: First stage provides 70% of full capacity; 2nd stage provides 100% of full capacity.</li> <li>• Three-stage heat: First stage provides 60% of full capacity; 2nd stage provides 80% of full capacity; third stage provides 100% of full capacity.</li> <li>• Four-stage heat: First stage provides 35 or 40% of full capacity; second stage provides 60% of full capacity; third stage provides 80% of full capacity; fourth stage provides 100% of full capacity.</li> </ul> <b>Load Tracking Variable Capacity:</b> Load tracking variable capacity will smoothly track the load (sensible temperature changes) up and down and adjust the furnace heating rate both ways. <b>Variable Capacity:</b> Variable capacity only tracks the load upward (rising temperature). Variable capacity uses the thermostat stage differentials but not stage timers.
<b>Gas Heating Activation Temp Difference</b> (Lennox Variable Capacity Heat Pumps)	When the system is dual-fuel and steady state while operating at full HP demand, this is the amount of °F (°C) below the set point that is allowed before allowing to switch to gas heat. Range is 0.5 to 10°F (0.0 to -5.56°C). Default is 1.5°F (1.30°C). Adjustments are in increments of 0.5°F (0.14°C).
<b>Heat Cool Stages Locked In</b>	
Heat Cool (H/C) Stages Lock in default is disabled (heat/cool stages are turned off separately). If changed to Enabled, heat/cool stages are turned off together. <i>For non-variable capacity systems only. See “Table 7. Smart hub Parameters - Heat Cool Stages Locked In” on page 34 for graphics.</i>	
<b>Group ID</b>	Multiple smart hubs in a home can be assigned to a group (up to nine groups with up to five smart hubs in each group). All smart hubs in a group can communicate with other smart hubs in the same group over the home Wi-Fi network. If a smart hub is set to Group ID 0, there will be no connectivity with another smart hub. Default Group ID is 1. Valid range is 0 to 9. (Recommend no more than 5 smart hubs per group. Doing so will eliminate possible Wi-Fi bandwidth issues.)
<b>HP Heating Lockout Time</b>	The HP could not get a zone to progress 0.5 degrees towards the set point in 120 minutes (Alert Code 40 - Minor alert). System will switch to secondary heat source. (Electric heat or furnace in dual fuel applications). Transition back to Heat Pump normal operation when termination setting times out. Range is 60 to 240 minutes. Default is 60 minutes. Adjustments are in increments of 30 minutes.

**Table 6. Smart Hub Parameters**

Parameter (In alphabetical order)	Description
<b>HP Heating Mode</b> (Lennox Variable Capacity Heat Pumps)	Options are Normal and Comfort. Default is Normal. The normal setting heats the home to the desired temperature setting. Modify the heating comfort mode to limit minimum compressor speed to 60 – 70 percent range and/or adjust comfort mode CFM. <ul style="list-style-type: none"> <li>• Normal is when the heat pump will heat the home will providing the highest efficiency.</li> <li>• Comfort is when the heat pump will deliver warmer air for comfort, but sacrifices on efficiency.</li> </ul>
<b>Humiditrol Comfort Adjust</b>	Options are Maximum Overcooling, Midpoint Overcooling and Minimum Overcooling. Default is Maximum Overcooling. <ul style="list-style-type: none"> <li>• Maximum Overcooling: Indoor temperature &gt; (greater than) two degrees above heating setpoint.</li> <li>• Midpoint Overcooling: Indoor temperature &gt; (greater than) HEAT setpoint + COOL setpoint / 2.</li> <li>• Minimum Overcooling: Indoor temperature &gt; (greater than) two degrees below cooling setpoint.</li> </ul> <p><b>NOTE:</b> Lennox variable capacity outdoor units are not compatible with Humiditrol (EDA).</p>
<b>Humidity Reading Calibration</b>	If it is determine that the actual humidity percentage being detected at the thermostat is off based on independent readings using other humidity reading devices, the display can be adjusted using this setting. Range is -10.0 to 10.0%. Default is 0.0%.
<b>Lock In 2nd Stage HP by Outdoor Temp</b> (Lennox Two-Stage Communicating Heat Pumps Only)	This accessory allows the unit to lock in second stage HP heating when the outdoor temperature goes below the jumper pin setting. Options are off, 40°F (4°C), 45°F (7°C), 50°F (10°C) and 55°F (13°C). Default is off.
<b>Max Heat Setpoint</b>	The highest temperature setting that the heat set point can be set on the thermostat. Default is 90.0F (32.33°C). Range is 60.0 to 90.0°F (15.56 to 32.22°C). Adjustable in increments of 1°F (0.56°C).
<b>Max Humidification Setpoint</b>	This setting will limit the highest humidification setting on the thermostat. This parameter will only appear when a humidifier accessory is installed. Range is 15 to 45%. Default is 45%. Adjustments are in increments of 1%.
<b>Min Cool Setpoint</b>	This setting will limit the lowest cooling temperature setting on the thermostat. Range is Range is 60.0 to 90.0°F (15.56 to 32.22°C). Default is 60°F (15.56°C). Adjustments are in increments of 1°F (0.56°C).
<b>Min Dehumidification Setpoint</b>	This setting will limit the lowest dehumidification setting on the thermostat. Range is 40 to 60%. Default is 40%. Adjustments are in increments of 1%.
<b>Minimum Gas Heating Off Time</b>	Range is 2.5 to 10 minutes. Default is 1.5 minutes. Adjustable in increments of .5 minutes.
<b>Modulating Cooling Cycles Per Hour</b> (Lennox Variable Capacity Outdoor Units)	This feature is activated when the structure BTU load is less than the minimum outdoor unit cooling capacity of the outdoor unit. The system will be cycled “ON” and “OFF” at the selected cycles per hour to maintain the settings of the thermostat. (This governs how many cycles per hour the system will try to run when it needs to run at less than minimum capacity). Range is 3 to 6 cycles hours. Can be adjusted in increments of 0.5. Default is 4.

**Table 6. Smart Hub Parameters**

Parameter <i>(In alphabetical order)</i>	Description
---	-------------

**Understanding Modulating Step Change and Steady State PI Gains**

Each of these terms has a multiplier (or gain) associated with it called the proportional gain and the integral gain respectively and affect responsiveness and stability

- **Standard** is a moderate gain suitable for nearly all installations.
- **More Aggressive** is a set of slightly higher gains that will make the system more responsive to changes, and will try harder to stay on the set point. This setting may cause some systems to oscillate.
- **Less Aggressive** is a set of slightly lower gains that will make the system less responsive and help to stabilize an oscillating system by sacrificing a small amount of time to set point.

None of the above options will cause the system to end a call if the demand for heating or cooling remains above the minimum capacity of the system since the algorithm is designed to find the demand that allows the system capacity to exactly match the house heating or cooling loss, creating a balance and constant temperature.

<b>Modulating Cooling Step Change PI Gain</b> <i>(Lennox Variable Capacity Outdoor Units)</i>	Step change gains deal with set point changes and affects how fast the system reaches the next set point. Options are <b>less aggressive</b> , <b>standard</b> and <b>more aggressive</b> . Default is <b>standard</b> .
<b>Modulating Cooling Steady State PI Gain</b> <i>(Lennox Variable Capacity Outdoor Units)</i>	Steady state gain controls the demand when the system is not responding to a sensed temperature change away from the iComfort thermostat setting. Options are <b>less aggressive</b> , <b>standard</b> and <b>more aggressive</b> . Default is <b>standard</b> .
<b>Modulating Gas Heating Cycles Per Hour</b> <i>(SLP98V only)</i>	This feature is activated when the structure BTU load is less than the minimum Heat Pump heating capacity of the outdoor unit. The system will be cycled “ON” and “OFF” at the selected cycles per hour to maintain the settings of the iComfort thermostat. (This governs how many cycles per hour the system will try to run when it needs to run at less than minimum capacity). Range is 4 to 10 cycles. Default is 6 cycles. Adjustments are in increments of 0.5 cycles.
<b>Modulating Gas Heating Step Change PI Gain</b> <i>(SLP98V only)</i>	This is applicable to the SLP98V only. Step change gains deal with set point changes and affects how fast the system reaches the next set point (Example: Adjustment to the thermostat setting). Options are <b>less aggressive</b> , <b>standard</b> and <b>more aggressive</b> . Default is <b>standard</b> . Recommend not changing this setting.
<b>Modulating HP Heating Cycles Per Hour</b> <i>(Lennox Variable Capacity Heat Pumps)</i>	This feature is activated when the structure BTU load is less than the minimum Heat Pump heating capacity of the outdoor unit. The system will be cycled “ON” and “OFF” at the selected cycles per hour to maintain the settings of the thermostat. (This governs how many cycles per hour the system will try to run when it needs to run at less than minimum capacity). Range is 3 to 6 cycles. Default is four cycles. Adjustments are in increments of 0.5 cycles.
<b>Modulating HP Heating Step Change PI Gain</b> <i>(Lennox Variable Capacity Heat Pumps)</i>	Step change gains deal with set point changes and affects how fast the system reaches the next set point (Example: Schedule change or adjustment to the thermostat setting). Options are <b>less aggressive</b> , <b>standard</b> and <b>more aggressive</b> . Default is <b>standard</b> . Recommend not changing this setting.
<b>Modulating HP Heating Steady State PI Gain</b> <i>(Lennox Variable Capacity Heat Pumps)</i>	Steady state gain controls the demand when the system is not responding to a sensed temperature change away from the thermostat setting. Options are <b>less aggressive</b> , <b>standard</b> and <b>more aggressive</b> . Default is <b>standard</b> . Recommend not changing this setting.

**Table 6. Smart Hub Parameters**

Parameter <i>(In alphabetical order)</i>	Description
<b>Number of Gas Heating Stages</b> <i>(SLP98V only)</i>	Number of selectable stages when Gas Heat Control Mode is set in “Staged” mode. Options are 1 through 4. Default is 4.
<b>Outdoor Temperature Reading Calibration</b>	This will allow for adjustment to the outdoor temperature display when the display temperature is off. Outdoor sensor is required. Range is -10 to 10°F (-5.56 to 5.56°C). Default is 0°F (0.0°C). Adjustments are in increments of 1°F. (0.56°C)
<b>Reset smart hub</b>	Reset smart hub (erases smart hub settings and restarts installer setup).
<b>Severe Weather Protection</b>	
(High and low temperature notification.)	
Options are enabled or disabled. Default is disabled. When enabled either the heat or freezing alert temperature setting will automatically generate a email notification to the homeowner that the applicable condition exist and homeowner interaction is required.	
<b>NOTE:</b> Notification is dependent on the thermostat having an active Wi-Fi connection and the user account has been setup and includes a valid email address.	
<b>Heat Alert Temperature</b>	This will notified the homeowner when the indoor temperature reaches the setting defined for this parameter. Range is 80°F to 100°F (26.67 to 37.78°C) with a factory default of 90°F (32.22°C). Increments adjusted by 1.0°F (0.56°C).
<b>Freezing Alert Temperature</b>	This will notified the homeowner when the indoor temperature reaches the setting defined for this parameter. Range is 30°F to 50°F (-1.11 to 10.0°C) with a factory default of 40°F 4.4°C). Increments adjusted by 1.0°F (0.56°C).
<b>Single Setpoint Mode (SSP)</b>	
(Non-Zoning System Only)	
On the user screens this is referred to as Perfect Temp (Temperature). Options are enabled or disabled. Default is disabled. The Single Set Point (SSP) algorithm allows the user the set only one temperature set point value rather than one value for heating and a different value for cooling. When zoning is present, the following SSP settings are not available. When enabled the following parameters are automatically configured for optimal settings. This setting is also available by going to <b>menu &gt; settings &gt; heat &amp; cool &gt; perfect temperature</b> and toggle the feature <b>ON</b> or <b>OFF</b> .	
<b>SSP Heating Cancel Coast Counter Increment Slope</b>	Range is 0 to 0.75°F (0.0 to 0.42°C). Default is 0.25°F (14°C). Adjustments are in increments of 0.125°F (0.07°C).
<b>SSP Heating Cancel Coast Counter Decrement Slope</b>	Range is 0.25 to 2°F (0.14 to 1.11°C). Default is 0.5°F (0.28°C). Adjustments are in increments of 0.125°F (0.07°C).
<b>SSP Cooling Cancel Coast Counter Increment Slope</b>	Range is -0.75 to 0.0°F (-0.42 to 0.0°C). Default is -0.25°F (-0.14°C). Adjustments are in increments of 0.125°F (0.07°C).
<b>SSP Cooling Cancel Coast Counter Decrement Slope</b>	Range is -2.0 to -0.25°F (-1.11 to -0.14°C). Default is -0.5°F (-0.28°C). Adjustments are in increments of 0.125°F (0.07°C).
<b>SSP Heating Lockout Outdoor Temp</b>	When the outdoor temperature is above this setting, heating is not allowed if single set point is running. Range is 50 to 80°F (10.0 to 26.67°C). Default is 70°F (21.11°C). Adjustments are in increments of 1.0°F (0.56°C).
<b>SSP Cooling Lockout Outdoor Temp</b>	When the outdoor temperature is below this setting, cooling is not allowed if single set point is running. Range is 30 to 60°F (-1.11 to 15.56°C). Default is 40°F (4.44°C). Adjustments are in increments of 1.0°F.

**Table 6. Smart Hub Parameters**

Parameter (In alphabetical order)	Description								
<b>Smart Alert Enable</b>	<p>Options are disabled, conservative, medium and aggressive. Default is disabled.</p> <ul style="list-style-type: none"> <li>• Disable - There is no monitoring of Smart Alert Enable.</li> <li>• Conservative - The system will wait longer to display any Smart Alert Enable alarms. This options allow for a minimum chance for false alarms being shown.</li> <li>• Medium (default) - Extensive testing by the Lennox development team to minimize the number of false alarms.</li> <li>• Aggressive - Will shorten time to display any Smart Alert Enable alarms.</li> </ul> <p><b>Smart Alert Enable function monitors:</b></p> <ul style="list-style-type: none"> <li>• Thermostat set point setting</li> <li>• Temperature reading</li> <li>• Determine whether the system moving towards the desired temperature setting or is unable to achieve the desire temperature setting.</li> <li>• Uses local climate design temperatures</li> <li>• System run times.</li> </ul> <p><b>NOTE:</b> Smart Alert Enable feature is disabled in a zoning system.</p> <p><b>NOTE:</b> Depending on type of system (conventional heating/cooling or heat pump system) and optional equipment not all system settings will be displayed.</p>								
<b>Smooth Setback Recovery (SSR)</b>	<p>When enabled, smooth set back begins recovery up to two hours before the programmed time so that the programmed temperature is reached at the corresponding programmed event time. Assume 12°F (6.72°C) per hour for first-stage gas/electric heating and 6°F (3.36°C) per hour for first-stage compressor based heating or cooling. With Smooth Set Back disabled, the system will start a recovery at the programmed time. Options are enabled or disabled. Default is enabled.</p> <p>The SSR set point calculation is as follows:</p> <div style="border: 1px solid black; padding: 10px; margin: 10px auto; width: fit-content;"> <table style="width: 100%; border-collapse: collapse;"> <tr> <td style="padding: 2px;">For New SSR CSP</td> <td style="padding: 2px;">Current SSR CSP</td> <td style="padding: 2px;">-</td> <td style="padding: 2px;"><math>\frac{\text{Current Program CSP} - \text{Target Program CSP}}{N}</math></td> </tr> <tr> <td style="padding: 2px;">For New SSR HSP</td> <td style="padding: 2px;">Current SSR HSP</td> <td style="padding: 2px;">-</td> <td style="padding: 2px;"><math>\frac{\text{Target Program HSP} - \text{Current Program HSP}}{N}</math></td> </tr> </table> <p style="margin-top: 5px;">Where: CSP = Cool Set Point  HSP = Heat Set Point  N = number of 30 second intervals to the target program set point  Note: N = 240 when target program set point is 2 hours away (maximum recovery time)</p> </div> <p>Rules for SSR:</p> <ul style="list-style-type: none"> <li>• SSR is enabled when both “Smooth Setback Recovery” is set to enabled (default) and the program schedule is turned on.</li> <li>• SSR does NOT turn off stage delay timers.</li> <li>• SSR will NOT change the dead band between heating and cooling modes.</li> <li>• SSR will not overshoot the target set point.</li> <li>• SSR will reset if the user updates the program schedule during the active SSR period</li> </ul>	For New SSR CSP	Current SSR CSP	-	$\frac{\text{Current Program CSP} - \text{Target Program CSP}}{N}$	For New SSR HSP	Current SSR HSP	-	$\frac{\text{Target Program HSP} - \text{Current Program HSP}}{N}$
For New SSR CSP	Current SSR CSP	-	$\frac{\text{Current Program CSP} - \text{Target Program CSP}}{N}$						
For New SSR HSP	Current SSR HSP	-	$\frac{\text{Target Program HSP} - \text{Current Program HSP}}{N}$						
<b>Stage Delay Timers</b> (First)	<p>Enabled (default) setting: When enabled all stage delay timers (stages 2 through 6) are enabled and will serve to bring on additional stage(s) of cooling or heating on a timed basis (default 20 minutes)</p> <p>Disabled setting: All stages delay timers are disabled. Heat/cool stages are changed based on temperature</p> <p><b>NOTE:</b> The second-stage delay timer (when stage timers is Enabled) is used for both HEATING and COOLING. However, if the system has a variable capacity furnace, zoning or variable outdoor unit, all stage delay timer will be ignored.</p>								

**Table 6. Smart Hub Parameters**

Parameter <i>(In alphabetical order)</i>	Description
<b>Stage Delay Timers</b> (2 through 6)	Second through Sixth Stage Delay timer (where applicable) - If staged delay timers are “Enabled”, the default is 20 minutes but can be programmed from 5 to 120 minutes in 5-minute increments. If the first stage fails to advance the ambient temperature toward the set point by 1.0°F (0.56°C) in the programmed delay time, then the second stage is activated.  <b>NOTE:</b> <i>The Second Stage Delay Timer (when Staged Delay Timers is Enabled) is used for both HEATING and COOLING. However, if the system has a variable capacity furnace, Second Stage Delay Timer will only be used for COOLING (not for heating, as the variable capacity algorithm ignores delay timers).</i>
<b>Stage Differentials</b> (First)	First Stage Differential - Stage 1 differential is used in all thermostats. The default is 1.0°F but can be programmed between 0.5° and 3.0°F in 0.5°F increments.
<b>Stage Differentials</b> (2 through 6)	Number of stages in thermostat is dependent on equipment that is installed.  <b>NOTE:</b> <i>Lennox variable capacity systems will stage electric heat but not on differentials. It will use the thermostat PI logic to stage the electric heat. If the system has a variable capacity furnace or zoning all stage differentials will be ignored.</i>
<b>Temp Reading Calibration</b>	Range is -5.0 to 5.0°F (-2.78 to -2.78°C). Default is 0.0°F (-0.0°C). If it is determine that the actual temperature being detected at the thermostat is off based on independent readings using other ambient temperature reading devices, the display can be adjusted using this setting.
<b>Temperature Control Mode</b>	The Feels-Like feature factors in the outdoor temperature and indoor humidity for a more accurate control of the temperature in the home. Either an outdoor temperature sensor is used or Internet Weather is enabled for this feature to operate. Modifying this setting here will also change the feature status on the user settings screen. <ul style="list-style-type: none"> <li>• <b>Normal</b> - This setting cools or heats the home to the desired temperature setting (Feels Like is OFF).</li> <li>• <b>Comfort</b> - This setting cools or heats the home to the desired temperature setting (Feels Like) is ON. When set to ON, other parameters are modified to optimal settings for this feature. Those setting changes will be listed on-screen when Comfort is enabled.</li> </ul> Default is <b>Normal</b> .
<b>Ventilation Control Mode - timed (default)</b>	
<b>Ventilation Minutes Per Hour</b>	Parameter range is 0.0 - 60.0 minutes. Default is 20.0 minutes. Can be adjusted in increments of 1.0 minutes. <ul style="list-style-type: none"> <li>• The system first tries to satisfy the ventilation time by only ventilating while conditioning is occurring. NOTE: Continuous fan is NOT considered conditioning.</li> <li>• When the required time remaining to ventilate for the hour does not equals the amount of time remaining in that hour, the system begins ventilation and does not stop until the ventilation time requirement is satisfied.</li> <li>• When ventilating without a conditioning demand, the ventilation output is active as well as a continuous indoor fan demand.</li> <li>• When ventilating with a conditioning demand, the ventilation output is active with the conditioning demand outputs.</li> </ul>
<b>Ventilation Rates</b>	
<b>Thermostat ventilation CFM parameters are to be adjusted only after the HRV/ERV set up is completed and the CFMs are known. Once the thermostat’s CFMs are adjusted they are used with the thermostat’s timer algorithm to determine how long to run the HRV/ERV and to change from low to high speed if a 2-stage HRV/ERVs.</b>	
<b>Ventilation Rate (Only listed for 1-speed ERV or HRV)</b>	Parameter range is 20 - 500 CFM. Default is 130 CFM. Can be adjusted in increments of 1.0 CFM.
<b>Ventilation Rate for Low Speed (Only listed for 2-speed ERV or HRV)</b>	Parameter range is 10 - 200 CFM. Default is 50 CFM. Can be adjusted in increments of 1.0 CFM.
<b>Ventilation Rate for High Speed (Only listed for 2-speed ERV or HRV)</b>	Parameter range is 20 - 500 CFM. Default is 130 CFM. Can be adjusted in increments of 1.0 CFM.

**Table 6. Smart Hub Parameters**

<b>Parameter</b> <i>(In alphabetical order)</i>	<b>Description</b>
<b>Ventilation High Outdoor Temperature Limit</b>	Parameter range is 60 to 115°F. Default is 100°F. Can be adjusted in increments of 5°F. While the outdoor temperature is equal to or higher than the setting for <b>Ventilation High Outdoor Temperature Limit</b> , ventilation does not run. When locked out due to high outdoor temperature, it will become unlocked when either the outdoor temperature is missing, or when the temperature reported is 1°F less than the <b>Ventilation High Outdoor Temperature Limit</b> setting when display units are in Fahrenheit, or is reported as 0.5°C less than lock out setting when the display units are Celsius.
<b>Ventilation Low Outdoor Temperature Limit</b>	Parameter range is -20 to 55°F. Default is 0°F. Can be adjusted in increments of 5°F. While the outdoor temperature is lower than the setting for the <b>Ventilation Low Outdoor Temperature Limit</b> , ventilation does not run. When locked out due to low outdoor temperature, it will become unlocked when the outdoor temperature is missing, or when the temperature reported is 1°F higher than the <b>Ventilation Low Outdoor Temperature Limit</b> setting when display units are Fahrenheit, or is reported as 0.5°C higher than lock out setting when the display units are Celsius
<b>Ventilation High Outdoor Dew Point Limit</b>	Parameter range is 45 to 80°F. Default is 55°F. Can be adjusted in increments of 5°F. While the outdoor dew point is higher than the setting for the high outdoor dew point limit, ventilation does not run. When locked out due to high outdoor dew point limit, it will become unlocked when the outdoor dew point is missing, or when the dew point temperature reported is 1°F less than the lock out setting when display units are Fahrenheit, or is reported as 0.5°C less than lock out setting when the display units are Celsius.

**Ventilation Control Mode - ASHRAE**

- In this mode the thermostat can assist the installer by validating the ventilation CFMs are capable of meeting the ASHRAE required ventilation volumes, but the thermostat has no ability to control CFM from the HRV/ERV.
- The system first tries to satisfy the ventilation volume by only ventilating while conditioning is occurring. Continuous fan is not considered conditioning.
- The total volume of ventilation air is accumulated and stored to compare against the target hourly ventilation volume (Vhr). The accumulated value resets each hour.
- When the remaining required volume of ventilation air for the hour divided by the fan only ventilation rate is equal to or greater than the time remaining to ventilate for the hour and no conditioning is occurring, the system begins ventilation using continuous fan and does not stop until the target hourly ventilation volume requirement is satisfied.
- When ventilating without a conditioning demand, the ventilation output is active as well a continuous indoor fan demand.
- When ventilating with a conditioning demand, the ventilation output is active with the conditioning demand outputs.
- When the system is ventilating, the user interface can indicate as such by showing “ventilating” to the user on the home screen.

**Ventilation Rates**

**Thermostat ventilation CFM parameters are to be adjusted only after the HRV/ERV set up is completed and the CFMs are known. Once the thermostat’s CFMs are adjusted they are used with the thermostat’s timer algorithm to determine how long to run the HRV/ERV and to change from low to high speed if a 2-stage HRV/ERVs.**

<b>Ventilation Rate</b> <b>(Only listed for 1-speed ERV or HRV)</b>	Parameter range is 20 - 500 CFM. Default is 130 CFM. Can be adjusted in increments of 1.0 CFM.
<b>Ventilation Rate for Low Speed</b> <b>(Only listed for 2-speed ERV or HR)</b>	Parameter range is 10 - 200 CFM. Default is 50 CFM. Can be adjusted in increments of 1.0 CFM.
<b>Ventilation Rate for High Speed</b> <b>(Only listed for 2-speed ERV or HRV)</b>	Parameter range is 20 - 500 CFM. Default is 130 CFM. Can be adjusted in increments of 1.0 CFM.
<b>Ventilation Outdoor Condition Override</b>	Options are Disabled (default) or Enabled.
<b>ASHRAE Compliance Check</b>	= NO (Ventilation CFM too low to comply with ASHRAE 62.2) or = YES (Current settings comply with ASHRAE 62.2)

**Table 6. Smart Hub Parameters**

Parameter (In alphabetical order)	Description
<b>ASHRAE Infiltration Credit</b>	Parameter range is 0.0 - 200.0 CFM. Default is 0 CFM. Can be adjusted in increments of 1.0 CFM.
<b>ASHRAE House Floor Area Served by This Ventilator</b>	Parameter range is 500.0 - 5000.0 square feet. Default is 2500.0 CFM. Can be adjusted in increments of 100.0 square feet. The formula for calculating how much ventilation is required is: <b>(Total square footage of the home/100) + (number of bedrooms+1) x 7.5 cfm</b>
<b>ASHRAE Number of Bedrooms</b>	Parameter range is 1.0 - 10.0. Default is 3.0. Can be adjusted in increments of 1.0.
<b>Fresh Air Damper Ventilation CFM</b>	Parameter range is 20 - 250 CFM. Default is 75 CFM. Can be adjusted in increments of 1.0.CFM
<b>Ventilation Outdoor Condition Override - Enabled</b>	
<b>Ventilation High Outdoor Temperature Limit</b>	Parameter range is 60 to 115°F. Default is 100°F. Can be adjusted in increments of 5°F. While the outdoor temperature is equal to or higher than the setting for <b>Ventilation High Outdoor Temperature Limit</b> , ventilation does not run. When locked out due to high outdoor temperature, it will become unlocked when either the outdoor temperature is missing, or when the temperature reported is 1°F less than the <b>Ventilation High Outdoor Temperature Limit</b> setting when display units are in Fahrenheit, or is reported as 0.5°C less than lock out setting when the display units are Celsius.
<b>Ventilation Low Outdoor Temperature Limit</b>	Parameter range is -20 to 55°F. Default is 0°F. Can be adjusted in increments of 5°F. While the outdoor temperature is lower than the setting for the <b>Ventilation Low Outdoor Temperature Limit</b> , ventilation does not run. When locked out due to low outdoor temperature, it will become unlocked when the outdoor temperature is missing, or when the temperature reported is 1°F higher than the <b>Ventilation Low Outdoor Temperature Limit</b> setting when display units are Fahrenheit, or is reported as 0.5°C higher than lock out setting when the display units are Celsius
<b>Ventilation High Outdoor Dew Point Limit</b>	Parameter range is 45 to 80°F. Default is 55°F. Can be adjusted in increments of 5°F. While the outdoor dew point is higher than the setting for the high outdoor dew point limit, ventilation does not run. When locked out due to high outdoor dew point limit, it will become unlocked when the outdoor dew point is missing, or when the dew point temperature reported is 1°F less than the lock out setting when display units are Fahrenheit, or is reported as 0.5°C less than lock out setting when the display units are Celsius.
<b>Wall Insulation</b>	Options are poor, average and good. Default is average.
<b>Zone 1 through 4 First Stage Differential</b>	Differential is the temperature between when first stage will cycle ON and cycle OFF. (Example: Zone 1 HD Display is set at 70°F (21°C) with a 1.0°F (0.56°C) differential. Cooling Demand - cooling will cycle ON when the room temperature reaches 70.5°F (21.4°C) and cycle OFF when the room temperature is 69.5°F (20.8°C). Range is 0.5 to 3°F (0.28 to 1.67°C). Default is 1°F (0.56°C). Adjustments are in increments of 1°F (0.56°C). <b>NOTE:</b> For Lennox variable capacity outdoor units the differentials are ignored.
<b>Zone 1 through 4 Continuous Blower CFM</b>	Minimum and maximum CFM will be dependent on system component configurations. These parameter values are automatically adjusted to the specific hardware configuration. See iHarmony zoning system installation instruction for minimum CFMs for specific indoor units. Zones requesting the fan ON are only allowed while no other zone demand is present. The thermostat will sum all the zone continuous blower CFM requirements and send the command only after positioning the dampers and waiting for the damper close delay period to expire (30 seconds) Continuous blower demands are the lowest priority demands, all other conditioning demands will over-ride the continuous blower demand. Range is 5 CFM to maximum of indoor unit. Default is dependent on tonnage of indoor unit. Adjustments are in increments of 5 CFM.
<b>Zone 1 through 4 Cooling CFM</b>	Minimum and maximum CFM will be dependent on system component configurations. These parameter values are automatically adjusted to the specific hardware configuration. See iHarmony zoning system installation instruction for minimum CFMs for specific indoor units. Target cooling CFM for a specific zone. Range is 5 CFM to maximum of indoor unit. Default is dependent on tonnage of indoor unit. Adjustments are in increments of 5 CFM.
<b>Zone 1 through 4 Heating CFM</b>	Minimum and maximum CFM will be dependent on system component configurations. These parameter values are automatically adjusted to the specific hardware configuration (See table 9 in iHarmony installation instruction for minimum CFMs for specific indoor units). Target heating CFM for a specific zone. Range is 5 to maximum of indoor unit. Default is dependent on tonnage of indoor unit. Adjustments are in increments of 5 CFM. Adjustments are in increments of 5 CFM.



**Table 6. Smart Hub Parameters**

Parameter <i>(In alphabetical order)</i>	Description
<b>Zoning Anticipated Discharge Air Temperature Adjustment</b>	This parameter setting compensates for a rapid change of the discharge air temperature due to fast changing conditions. It examines the change in the discharge air temperature for the previous two minutes and extrapolates or looks forward by the number of seconds set in the parameter and uses this as the DATS value for staging. This parameter setting helps prevent limit trip/frozen coil from occurring. Range is 0 to 120 seconds. Default is 0 seconds. Adjustments are in increments of 5 seconds.
<b>Zoning Gas Heating DAT Cool Down Target</b>	At the end of a gas cycle, the Heat Blower Off-Delay may not be long enough to completely cool the heat exchanger. This may result in a primary limit trip then, or at the beginning of the next heat demand. This parameter allows the blower to run after a gas heat call ends until the discharge air temperature sensor (DATS) cools to the temperature set in the parameter. If the temperature is set too low this will cause the temperature in the room to overshoot. Range is 80 to 90°F (26.67 - 32.22°C). Default is 90°F (32°C). Adjustments are in increments of 1°F (0.56°C).
<b>Zoning Initial Staging Hold Time for Gas Heating</b>	In zoning systems, the furnace was upstaging before the discharge air sensor reached a steady-state value and it would sometimes trip a limit due to staging up the gas before the blower would even come on (as occurs during pressure switch calibration). In addition and options for delaying the first staging event even further since the starting point of the modulation gas heat in zoning is picked to be appropriate for the airflow being provided, so this parameters allows an adjustment on top of the initial delay. Range: 3.0 – 8.0 minutes, with a default: 5.0 minutes. Can be adjusted in 1 minute increments.
<b>Zoning Minimum Zone Run-Time</b>	Range is 90 to 600 seconds. Default is 120 seconds. Adjustments are in increments of 30 seconds.
<b>Zoning Supply Air Temp Limit for Cooling</b>	In cooling mode, this setting sets the discharge air temperature low limit. Below this temperature, the cooling is turned off. Range is 35 to 45°F (1.67 - 7.22°C). Default is 40°F (4.44°C). Adjustments are in increments of 1°F (0.56°C).
<b>Zoning Supply Air Temp Limit for Gas / Electric Heating</b>	In heating mode, this setting sets the target discharge air temperature. Range is 120 to 160°F (48.88 to 54.44°C). Default is 125°F (52°C). Adjustments are in increments of 5°F (2.78°C).
<b>Zoning Target Supply Air Temp for Cooling</b>	In cooling mode, this setting sets the target discharge air temperature. Range is 40 to 60°F (4.44 - 15.56°C). Default is 45°F (7.22°C). Adjustments are in increments of 1°F (0.56°C).
<b>Zoning Target Supply Air Temp for HP Heating</b>	In heat pump heating mode, this setting sets the target discharge air temperature. Range is 85 to 110°F (29.44 to 43.33°C). Adjustments are in increments of 1°F (0.56°C). Default 90°F (32°C) plus 20 degrees overshoot for both stage and modulating systems.
<b>Zoning Target Supply Air Temp for Gas/Electric Heating</b>	Default is 110°F. Range is 100°F to 130°F with 1 degree increment adjustable. In heating mode, this setting sets the target discharge air temperature. Default 100°F (38°C) plus 20 degrees overshoot for both stage and modulating systems.

**Table 7. Smart hub Parameters - Heat Cool Stages Locked In**

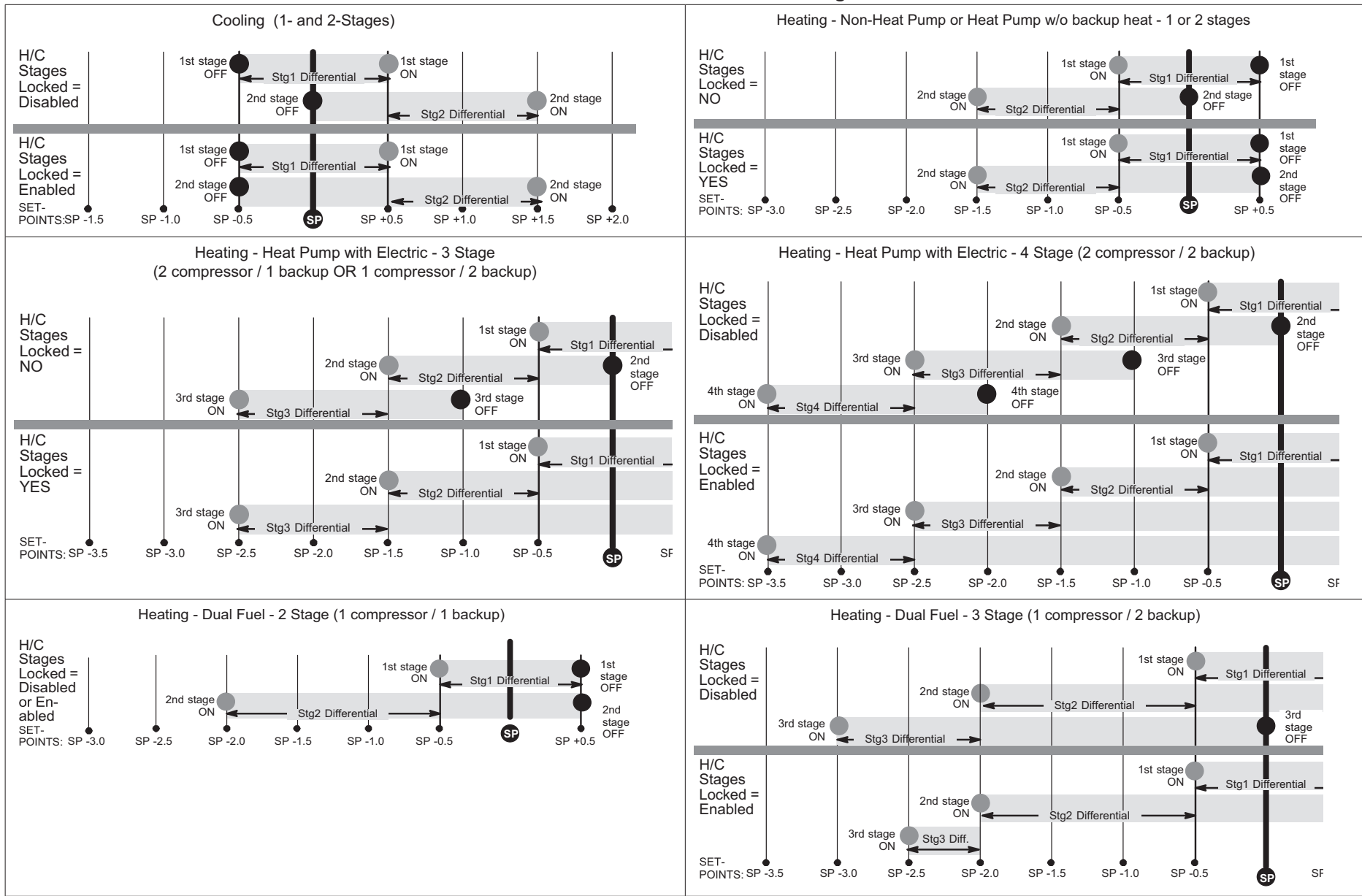

**Table 7. Smart hub Parameters - Heat Cool Stages Locked In**

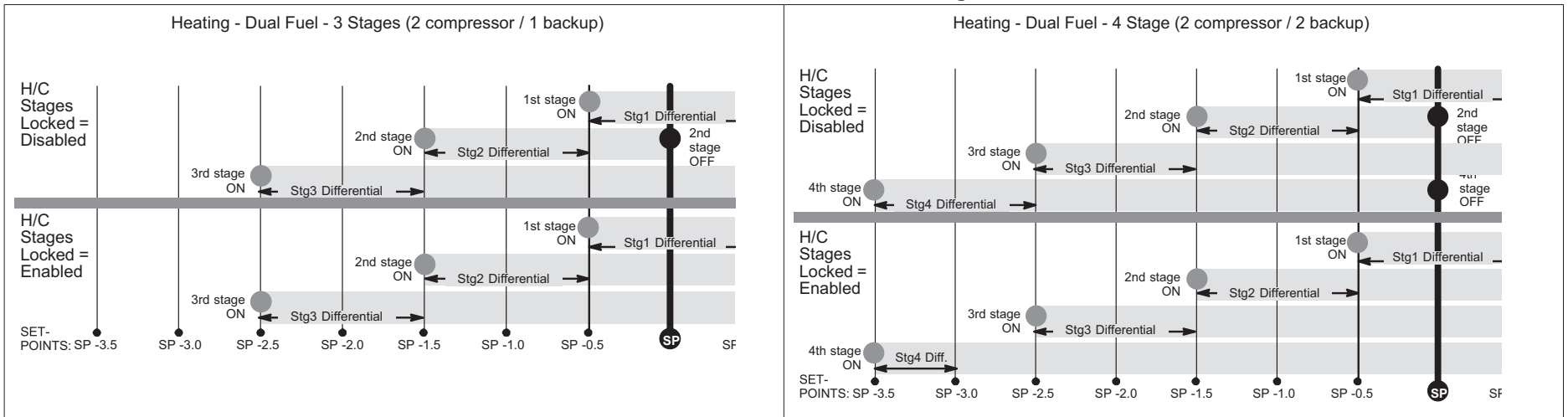

**Table 8. Heat Pump Parameters**

Parameter	Description
<b>About</b>	This screen provides information concerning language supported, equipment type name, unit model number, unit serial number, unit nominal capacity, number of heating states, number of cooling stages, heating capacity by stage, cooling capacity by stage, control software revision, control model number, control serial number, control hardware revision, outdoor air temp sensor, protocol revision number, device product level, 24VAC average power consumption, 24VAC peak power consumption, line voltage average power consumption, line voltage peak power consumption, outdoor inverter model number, outdoor inverter firmware version, outdoor fan RPM profile, unit code, compatible devices list, application code memory size and micro-controller part number.
<b>Automatic Max Defrost</b> <i>(Single and Two-Stage Lennox Communicating Heat Pump Units)</i>	When set to <b>ON</b> , the system will always run at MAX DEFROST when accumulated compressor off time is longer than 30 minutes and ambient temperature is less than 35°F (1.6°C). When ambient sensor temperature is higher than 40°F (4.5°C) then defrost termination will be 90°F (32°C). This option has two settings, either <b>ON</b> or <b>OFF</b> . Default is <b>OFF</b> .
<b>Compressor Shift Delay ON / OFF</b>	<b>Single and Two-Stage Heat Pumps:</b> This feature reduces sounds that occur while the unit is cycling in and out of the defrost mode. <ul style="list-style-type: none"> <li>When enabled, there is a 30-second compressor shift delay which de-energizes the contactor and ECM fan outputs. After the delay expires, the contactor and ECM fan outputs are energized.</li> <li>When disabled, the reversing valve is shifted by de-energizing the outputs.</li> </ul> <b>Variable Capacity Heat Pumps:</b> <ul style="list-style-type: none"> <li>The “Shift delay” is not a technician settable parameter on variable capacity heat pumps.</li> <li>“Shift Delay” is always enabled going into and out of a defrost. the inverter was updated with “slope logic” and shift delay is always enabled. The shift delay is: Compressor shut off &gt; 4s delay &gt; reversing valve shifts &gt; 26s delay &gt; compressor restarts.</li> </ul>
<b>Compressor Short Cycle Delay'</b> <i>(Single and Two-Stage Lennox Communicating Outdoor Units)</i>	This feature prevents the compressor from being short cycled any time the compressor is turned “OFF”. The range is 60 - 300 seconds. Default is 300 seconds and with an incremental adjustment of 60 seconds. When the system initiates a compressor short cycle delay, the outdoor unit control's seven segment display will count down the delay in minutes 1 to 5 minutes. The sequence is time remaining and a dash, and will repeat that cycle (5, 4, 3, 2 and 1) until the count down is complete. If the delay timer is change to let's say 180 seconds, then the countdown will start at 3.

**Table 8. Heat Pump Parameters**

Parameter	Description
<p><b>Defrost Termination Temp</b> (Single and Two-Stage Lennox Communicating Heat Pump Units)</p>	<p>This is the temperature that defrost mode will be terminated. In dual fuel applications (furnace and heat pump), defrost tempering is automatically enabled and operates as follows:</p> <ul style="list-style-type: none"> <li>• Furnace will run for 75 seconds ON then after 90 seconds OFF for two cycles.</li> <li>• After the first two cycles, the furnace will run for 60 seconds ON then cycle OFF for 90 seconds.</li> <li>• This cycle will be repeated until the room thermostat is informed by the outdoor control that defrost has terminated.</li> </ul> <p>The range is 50 - 100°F (10.0 to 37.78°C). Default is 50°F (10.0°C) and with an incremental adjustment of 10°F (5.56°C). <b>Variable capacity - Both Furnace and Heat Pump are Modulating:</b></p> <p>When the thermostat receives information that the heat pump has entered defrost the thermostat sends a minimum rate heating demand to the furnace. Then the thermostat terminates the minimum rate heating demand upon defrost completion or any time the heat pump stops. (i.e., pressure switch opens, mode switch changes, etc.)</p> <p><b>Staged – Both Furnace and Heat Pump are Multi-Stage:</b></p> <p>When the thermostat receives information that the heat pump has entered defrost the thermostat performs the following :</p> <ul style="list-style-type: none"> <li>• Sends a first stage heating demand to the furnace.</li> <li>• After 75 seconds elapse from the time the first stage demand was sent, the thermostat terminates the furnace heating demand.</li> <li>• After the furnace minimum off time has elapsed (90 seconds) from the time the previous heating termination, the thermostat starts first stage furnace heat again by sending the first stage heating demand. This is the new adjustable gas heat delay setting for zoning.</li> <li>• After 60 seconds elapse from the previous heating demand being sent, the thermostat terminates the furnace heating demand.</li> <li>• Repeat steps 3 and 4 while defrost is active, terminating any running furnace heat demand when the HP indicates that defrost is no longer active or any time the heat pump stops. (i.e., pressure switch opens, mode switch changes, etc.)</li> </ul> <p><b>NOTE:</b> The on times above assume the minimum furnace ignition time of 35 seconds.</p>
<p><b>Dehum Airflow Adjustment Adder</b> (Lennox Variable Capacity Heat Pumps Only)</p>	<p>Dehumidification airflow = HUMID Mode CFM table value for a given thermostat demand + dehumidification adjustment adder (High Normal Cooling Airflow CFM x Dehumidification Airflow Adjustment Adder in percentage).</p> <p>Both these values are in the installer set up under dealer control center &gt; equipment &gt; heat pump. Range is 0 to 30%. Default is 28%.</p> <p><b>NOTE:</b> Deactivated in auxiliary dehumidification and enhanced dehumidification accessory (Humiditrol)</p>
<p><b>Equipment Name</b></p>	<p>A unique name can be assigned to this component. Name can be up to 29 characters. Name can consist of letters, numbers, special characters and spaces.</p>
<p><b>High Normal Cooling Airflow</b> (Lennox Variable Capacity Heat Pumps Only)</p>	<p>Thermostat values shown are defaults. This value can be adjusted up or down to meet each application requirements. The range is 450 - 2150 CFM. Default is dependent on unit capacity with an incremental adjustment of 25 CFM.</p>
<p><b>Fan Cycling</b> (Single and Two-Stage Lennox Communicating Heat Pumps)</p>	<p>Options are ON or OFF. Default OFF.</p>
<p><b>High Normal HP Heating Airflow</b> (Lennox Variable Capacity Heat Pumps Only)</p>	<p>Thermostat values shown are defaults. This value can be adjusted up or down to meet each application requirements. The range is 450 - 2150 CFM. Default is dependent on unit capacity with an incremental adjustment of 25 CFM.</p>
<p><b>Low Normal Cooling Airflow</b> (Lennox Variable capacity Heat Pumps Only)</p>	<p>Thermostat values shown are defaults. This value can be adjusted up or down to meet each application requirements. The range is 450 - 2150 CFM. Default is dependent on unit capacity with an incremental adjustment of 25 CFM.</p>

**Table 8. Heat Pump Parameters**

Parameter	Description
<b>Low Normal HP Heating Airflow</b> <i>(Lennox Variable Capacity Heat Pumps Only)</i>	Thermostat values shown are defaults. This value can be adjusted up or down to meet each application requirements. The range is 450 - 2150 CFM. Default is dependent on unit capacity with incremental adjustment of 25 CFM.
<b>Max Defrost by Weather</b> <i>(Single and Two-Stage Lennox Communicating Heat Pump Units)</i>	Options are off and on. Default is off. When set to on, information from the default Internet weather source is used to determine when Max Defrost is used.
<b>Reset Heat Pump</b>	Any installer modifications under the heat pump tab will be reset back to the factory defaults if the reset heat pump option is used.

**Table 9. Air Conditioner Parameters**

Parameter	Description
<b>About</b>	This screen provides information concerning language supported, equipment type name, unit model number, unit serial number, unit nominal capacity, number of cooling stages, cooling capacity by stage, control software revision, control model number, control serial number, control hardware revision, outdoor air temp sensor, protocol revision number, device product level, 24VAC average power consumption, 24VAC peak power consumption, line voltage average power consumption, line voltage peak power consumption, outdoor inverter model number, outdoor inverter firmware version, outdoor fan RPM profile, unit code, compatible devices list, application code memory size and micro-controller part number.
<b>Compressor Short Cycle Delay</b>	This feature prevents the compressor from being short cycled any time the compressor is turned "OFF". The range is 60 - 300 seconds. Default is 300 seconds and with an incremental adjustment of 60 seconds. When the system initiates a compressor short cycle delay, the outdoor unit control's seven segment display will show the delay in minutes from 1 to 5 minutes. The sequence is time (minutes) remaining and a dash, and will repeat that cycle (5, 4, 3, 2 and 1) until the count down is complete. If the delay timer is change for example to 180 seconds, then the countdown will start at 3 (minutes).
<b>Dehum Airflow Adjustment Adder</b>	Dehumidification airflow = "HUMID" Mode CFM table value for a given thermostat demand + dehumidification adjustment adder (High Normal Cooling Airflow CFM x Dehumidification Airflow Adjustment Adder in percentage. Both these values are in the installer set up under System Device/Air Conditioner/High Normal Cooling Airflow).
<b>Equipment Name</b>	A unique name can be assigned to this component. Name can be up to 29 characters. Name can consist of letters, numbers, special characters and <b>spaces</b> .
<b>High Normal Cooling Airflow</b> <i>(Lennox Variable Capacity Air Conditioners Only)</i>	The range is 450 - 2150 CFM. Default is dependent on unit capacity with an incremental adjustment of 25 CFM. Thermostat values shown are defaults. This value can be adjusted up or down to meet each application requirements.
<b>Low Normal Cooling Airflow</b> <i>(Lennox Variable Capacity Air Conditioners Only)</i>	The range is 450 - 2150 CFM. Default is dependent on unit capacity with an incremental adjustment of 25 CFM. Thermostat values shown are defaults. This value can be adjusted up or down to meet each application requirements.
<b>Reset Air Conditioner</b>	Any installer modifications under the air conditioner tab will be reset back to the factory defaults if the reset air conditioner option is used.

**Table 10. Air Handler Parameters**

Parameter	Description
<b>About</b>	Provides information concerning unit code, language support, equipment type name, unit model number, unit serial number, unit nominal capacity, number of heating states, heating capacity by stage, indoor blower CFM range, control software revision, control model number, control serial number, control hardware revision, discharge air temp sensor, outdoor air temp sensor, protocol revision number, device product level, factory installed transformer, 24VAC average power consumption, 24VAC peak power consumption, line voltage average power consumption, line voltage peak power consumption, compatible devices list, applicable code memory size, and micro-controller part number.
<b>Airflow Profile - Cooling</b>	Options are: 1 - No delays. 2 - ON: No delays; OFF: 45 sec delay. 3 - ON: 82% - 7-1/2 minutes; OFF: No delays. 4 - ON: 50% - 30 seconds at 82% - 7-1/2 minutes at 100% and finish cycle 50% / 30 seconds off.
<b>Continuous Indoor Blower Airflow</b>	Range of operation of the indoor blower during continuous blower operation. The range is 450 to 2150 CFM. Default is dependent on component match-up. Incremental adjustments are made in 5 CFM. <b>NOTE:</b> All iComfort parameter default CFM values are based on Air Handler Control (AHC) DIP switch setting (non-communicating value) prior to power up. This dip switch settings are use and calculated using CFM conversion tables. They are then rounded up to closest number on 25 CFM resolution. Any DIP switch changes made after power up are ignore.
<b>Cooling Indoor Blower Off Delay</b>	The range is 0 - 30 seconds. Default is 0 seconds with an incremental adjustment of 2 seconds.
<b>Cooling Indoor Blower On Delay</b>	The range is 0 - 10 seconds. Default is 2 seconds with an incremental adjustment of 1 second.
<b>Electric Heating Airflow</b>	Range of operation of the indoor blower during electric heat operation. The range is 1560 to 2150 CFM. Default is dependent on unit capacity with an incremental adjustment of 5 CFM.
<b>Equipment Name</b>	A unique name can be assigned to this component. Name can be up to 29 characters. Name can consist of letters, numbers, special characters and spaces.
<b>Heating Indoor Blower Off Delay</b>	Heating Indoor Blower OFF Delay (Electric Heat only -Blower runs at continuous air CFM setting during delay timing period). The range is 0 - 10 seconds. Default is 10 seconds with an incremental adjustment of 1 second.
<b>Heating Indoor Blower On Delay</b>	The range is 0 - 5 seconds. Default is 0 seconds with an incremental adjustment of 1 second.
<b>High Cooling Airflow</b>	Range of operation of the indoor blower during high cooling operation. The range is 1560 to 2150 CFM. Default is based on cooling demand with an incremental adjustments of 25 CFM.
<b>High HP Airflow</b>	Range of operation of the indoor blower during high heat pump operation. Information below is example only and exact air flow range is dependent on equipment tonnage. Use your example and add adjustment increments of +/-25 CFM Example: The range is 800 -1100 CFM. Default setting is depending on unit tonnage. Can be incrementally adjusted by 25 CFM.
<b>HP Indoor Blower Off Delay</b>	Heat Pump Indoor Blower OFF Delay (Heat Pump only - Blower runs at continuous air CFM setting during delay timing period). The range is 0 - 60 seconds. Default is 45 seconds with an incremental adjustment of 5 seconds.
<b>HP Indoor Blower On Delay</b>	The range is 0 - 30 seconds. Default is 0 seconds with an incremental adjustment of 5 seconds.
<b>Low Cooling Airflow</b>	Range of operation of the indoor blower during low cooling operation. The range is 450.0 to 2150 CFM. Default is based on cooling demand with an incremental adjustments of 25 CFM.
<b>Low HP Airflow</b>	Range of operation of the indoor blower during low heat pump operation. Information below is example only and exact air flow range is dependent on equipment tonnage. Use your example and add adjustment increments of +/-25 CFM. Example: The range is 450 - 600 CFM. Default setting is depending on unit tonnage. Can be incrementally adjusted by 25 CFM.
<b>Reset Air Handler</b>	Any installer modifications under the air handler tab will be reset back to the factory defaults if the reset air handler option is used.

**Table 11. Furnace Parameters**

Parameter	Description
<b>About</b>	This screen provides information on unit code, language supported, equipment type name, unit model number, unit serial number, unit nominal capacity, number of heating stages, heating capacity by stage, indoor blower CFM range, control software revision, control model number, control serial number, control hardware revision, discharge air temp sensor, outdoor air temp sensor, protocol revision number, device product level, factory installed transformer, 24VAC average power consumption, 24VAC peak power consumption, line voltage average power consumption, line voltage peak power consumption, compatible devices list, application code memory size and micro-controller part number.
<b>Airflow Profile - Cooling</b>	Options are: A - ON: 50% - 30 seconds at 82% - 7-1/2 minutes at 100% and finish cycle 50% / 30 seconds off. B - ON: 82% - 7-1/2 minutes at 100% and finish cycle off. C - ON: 100% - No delays; OFF: 45 seconds. D - no delays.
<b>Continuous Indoor Blower Airflow</b>	The range is 450 - 2000 CFM with a default setting based on equipment type match-up. Adjustments are in increments of 5 CFM. <b>NOTE:</b> All parameter default CFM values are based on Furnace Control (IFC) DIP switch setting (non-communicating value) prior to power up. This dip switch settings are use and calculated using CFM conversion tables. They are then rounded up to closest number on 25 CFM resolution. Any DIP switch changes made after power up are ignore.
<b>Cooling Indoor Blower Off Delay</b>	The range is 0.0 - 30.0 seconds with a default setting base on equipment type match-up. Adjustment are increments of 10 seconds. Default is 0.0 seconds.
<b>Cooling Indoor Blower On Delay</b>	The range is 0.0 - 10.0 seconds with a default setting base on equipment type match-up. Adjustment are increments of 1 second. Default is 2.0 seconds.
<b>Dehumidification Airflow %</b>	Range is 60.0 to 80.0%. Default is 70.0%
<b>Equipment Name</b>	A unique name can be assigned to this component. Name can be up to 29 characters. Name can consist of letters, numbers, special characters and spaces.
<b>Heating Indoor Blower Off Delay</b>	The range is 60 - 180 seconds with a default setting base on equipment type match-up. Adjustment are increments of 10 seconds.
<b>Heating Airflow Control Type</b>	Options for this setting are <b>fixed CFM</b> or <b>fixed DAT</b> (discharge air temperature). Default is dependent on equipment type match-up. <b>Fixed CFM</b> is selected as the Heating Airflow Control Type (parameter default selection), the circulator will operate at a CFM that is linearly interpolated between Low Heating Airflow and High Heating Airflow based on the current IFC firing rate. For example, if the firing rate is 60% and Low Heating Airflow and High Heating Airflow were set to 500 CFM and 900 CFM respectively (both parameter values are set during the IFC commission), the circulator will run at $297 \text{ CFM} = 500 + (900-500) * (60-40)/(100-40)$ – assuming 40% minimum fire rate. <b>Fixed Discharge Air Temperature (DAT)</b> control when selected as Heating Airflow Control Type, the IFC will vary circulator at a CFM to maintain a set Discharge Air Temperature (DAT). For example if the firing rate is 60% and Low Heating DAT and High Heating DAT were set to 115°F (46°C) and 130°F (54.4°C) respectively (both parameter values are set during the IFC commission), the IFC will control the circulator to maintain a DAT at $120^\circ\text{F} (48.9^\circ\text{C}) = 115 + (130-115) * (60-40)/(100-40)$ – assuming 40% minimum fire rate. When Fix DAT is enabled, the following parameters are available: <b>Low Heating Discharge Temp</b> Range is 105 to 135°F (43.44 to 60.0°C). Adjustable in increments of 5F (2.78°C). Default is 120°F (51.67°C). <b>High Heating Discharge Temp</b> Range is 115 to 145°F (48.89 to 65.56°C). Adjustable in increments of 5F (2.78°C). Default is 130°F (57.22°C).
<b>Heating Indoor Blower On Delay</b>	The range is 15 - 45 seconds with a default setting base on equipment type match-up. Adjustment are increments of 5 seconds.
<b>High Cooling Airflow</b>	Range of operation of the indoor blower during high cooling operation. The range is dependent of indoor unit model and size. Default is based on cooling demand with an Incremental adjustments of 25 CFM.
<b>High Heating Airflow</b>	Both range and default setting is based on equipment type match-up. Adjustments are in increments of 25 CFM. This value is automatically adjusted by the system based on heating airflow control type used.

**Table 11. Furnace Parameters**

Parameter	Description
<b>High HP Airflow</b>	Range is 800.0 to 1100.0 CFM. Default is 967.0 CFM.
<b>HP Indoor Blower Off Delay</b>	The range is 0.0 - 60.0 seconds with a default setting base on equipment type match-up. Adjustment are increments of 5 seconds. Default is 45.0 seconds.
<b>HP Indoor Blower On Delay</b>	The range is 0.0 - 30.0 seconds with a default setting base on equipment type match-up. Adjustment are increments of 5 seconds. Default is 0.0 seconds.
<b>Low Cooling Airflow</b>	Range of operation of the indoor blower during low cooling operation. The range is dependent of indoor unit model and size. Default is based on cooling demand with an Incremental adjustments of 25 CFM.
<b>Low Heating Airflow</b>	Both range and default setting is based on equipment type match-up. Adjustments are in increments of 25 CFM. This value is automatically adjusted by the system based on heating airflow control type used.
<b>Minimum Gas Heating Off Time</b>	Default is 1.5 minutes. Range is 1.5 to 10 minutes. With increments of 0.5. This setting will help with the Alarm 250 limit tripping in zoning applications where a second zone calls immediately after the satisfying a gas heating call and there is still residual heat in heat exchanger.
<b>Reset Furnace</b>	Any installer modifications under the furnace tab will be reset back to the factory defaults if the reset furnace option is used.

**Table 12. Zoning Control Parameters**

Parameter	Description
<b>About</b>	This provides information on unit code, language supported, equipment type name, control software revision, control model number, control serial number, control hardware revision, protocol revision number, device product level, 24VAC average power consumption, 24VAC peak power consumption, compatible devices list, application code memory size, micro-controller part number, max number of zones, supported damper types, number of damper positions, zone temp sensor 1, zone temp sensor 2, zone temp sensor 3 and zone temp sensor 4.
<b>Equipment Name</b>	A unique name can be assigned to this component. Name can be up to 29 characters. Name can consist of letters, numbers, special characters and spaces.
<b>Zones 1 through 4 Temp Reading Calibration</b>	Allows adjustment to temperature reading displayed on zone thermostat.
<b>Reset Zoning Control</b>	Any installer modifications under the zoning control tab will be reset back to the factory defaults if the reset zoning control option is used.

**Table 13. Thermostat (HD Display) Parameters**

Parameter	Description
<b>About</b>	This screen provides information concerning model number, serial number, hardware revision, software revision, language support and equipment type name.
<b>Auto Brightness</b>	Options are on and off. Default is off.
<b>Brightness Value</b>	The brightness range is 0 - 100. Default 80. Touch either the + or - button to increase or decrease the setting.
<b>Display Pure Air</b>	Options are on and off. Default is off. Default is on. When on it will display the PureAir S information on the home screen. Setting is ignore if PureAir S is not installed.
<b>Display Indoor Humidity</b>	Options are on and off. Default is off.
<b>Display Outdoor Weather</b>	Options are on and off. Default is off.



**Table 13. Thermostat (HD Display) Parameters**

Parameter	Description
<b>Outdoor Temperature Source</b>	Options are off, Internet (AccuWeather) or sensor. Default is Internet (AccuWeather).
<b>Proximity Control</b>	Options are ON and OFF. Default is OFF. Is used to wake-up the display from screen saver mode when motion near the HD Display is detected.
<b>Reset thermostat</b>	Resets the thermostat settings to factory default.
<b>Screen Locked</b>	Options are unlocked, partially locked and locked. Default is unlocked.
<b>Screen Saver</b>	Options are off, weather, power save and logo. Default is off. <b>NOTE:</b> <i>When the user performs a picture upload from the settings &gt; display &gt; screen saver page, then on this screen it will only indicate that logo was selected. If no picture has been uploaded, then the Lennox logo would be displayed.</i>
<b>Wide Setpoint</b>	Options are ON and OFF. Default is OFF. This allows a wider low and high temperature. Normal range is 60 to 90°F (15.6 to 32.2°C) . When this parameter is set to ON, the range is 40 to 100°F (4.4 to 37.8°C). This feature can also be set through the user interface setting screen. From the home screen go to menu > settings > heat & cool (or it may be just heat or cool) > wider set-point range.

**Table 14. PureAir S Parameters**

Parameter	Description
<b>Equipment</b>	PureAir Filter
<b>Dirty Filter Detection and UV Life Detection</b>	Default: ON. Options are either ON or OFF. This parameter turns on and off the filter life and UV lamp life reporting. When set to off, the control will continue to calculate the remaining filter life through continuous sampling, but will not use filter tests to determine filter life. The control will: <ul style="list-style-type: none"> <li>• Perform a filter calibration upon indication of a filter change regardless of the value of this parameter.</li> <li>• Perform a UVA lamp calibration upon indication of a lamp change regardless of the value of this parameter.</li> <li>• Calculate UVA lamp life remaining regardless of the value of this parameter.</li> </ul> Alarms 504 and 503 will not be sent while this parameter is set to "Off" The Diagnostics screen on the thermostat will continue to show values for both filter life and UV lamp life regardless of the value of this parameter.
<b>Max Air Filtered between Tests</b>	Default is 100%, Range is 50% to 100% Changes can be made in increments of 10%. This parameter: <ul style="list-style-type: none"> <li>• Modifies the amount of air that is allowed to pass through the filter after a valid % life determination before a filter test is initiated.</li> <li>• Expressed as a percentage of the cubic feet of air that would pass through the filter if the fan operated at continuous fan CFM for 30 days.</li> </ul>
<b>UV lamp operation detection</b>	Default: ON. Options are either ON or OFF.
<b>Filter Life</b>	Provides percentage of remaining filter life. This is for display purposes only and cannot be changed.
<b>Last replacement date for filter</b>	Date last filter reset was accomplished. This is for display purposes only and cannot be changed
<b>Purifier life</b>	Provides percentage of remaining purifier life. This is for display purposes only and cannot be changed
<b>Last replacement date for purifier</b>	Date last purifier insert reset was accomplished. This is for display purposes only and cannot be changed

- Reset **PureAir S** will reset all **PureAir S** parameters back to factory defaults.
- Reset purifier will reset it to 100%. This is usually accomplished after the purifier insert has been replaced.
- Reset filter will reset it to 100%. This is usually accomplished after the air filter has been replaced.

**Table 15. Utilities**

Parameter	Description
Restart smart hub	Restarts the smart hub.
Re-configure System	Re-configure HVAC system.
Reset HVAC Equipment	Resets all HVAC equipment.
Factory Reset Thermostat	Resets thermostat to factory default settings.
Factory Reset smart hub	Resets smart hub parameters back to factory default.

## Tests

Verify Airflow Per Zone is the first screen to appear under this selection. If no zoning is installed, zone airflow settings will be for zone 1 only. If zoning equipment is detected by the system then zones 1 through 4 will be listed. These screens allow for verification and modification of CFMs for blower, heating and cooling circulation. Touch continue to proceed to the next screen.

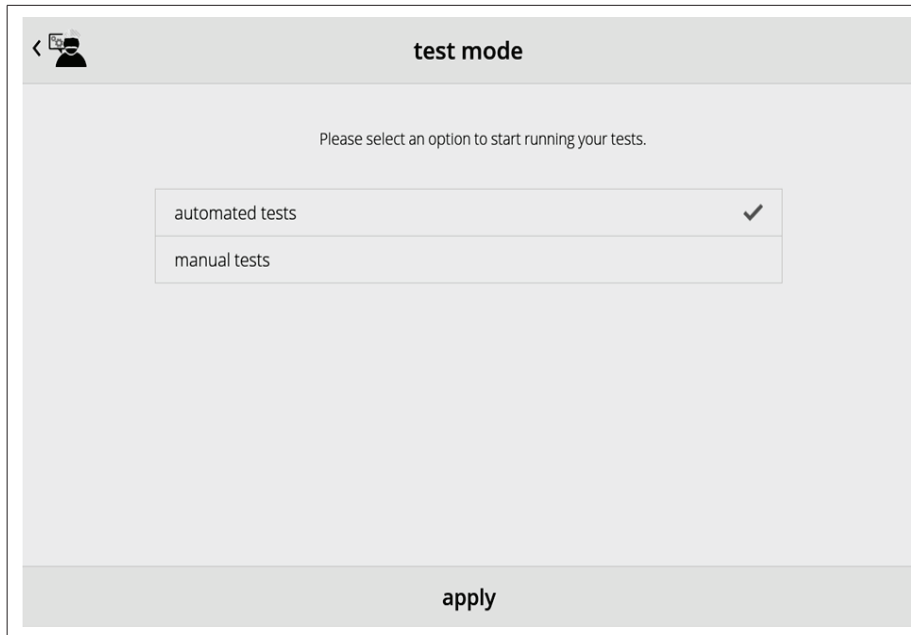

**Figure 20. PureAir S Performance Status Screen**

Select **Test Mode** is the next screen to appear. Your options are automated tests or manual tests. Select the desired option and select **apply**.

- **Automated Tests:** Select this options and the next screen will allow you to select the specific tests available for your hardware configuration. The test are automatic and no installer / service technician’s attendance is required. When the automatic testing is complete the system returns to the consumer home screen. A updated installation report is generated and available in Lennox Pros under the Homeowners account.
- **Manual Test:** Depending on hardware present, various tests are available. By default all items to be tested are enabled. Selecting a specific test will un-check the item. When a specific set of tests are completed the results will be displayed on the screen next to the tested item. Touch continue to proceed to the next set of test items. Once all tests are completed press done to return to the touch tests to run screen. Touch the left arrow at the top left side of screen to return to the Dealer Control Center

## Diagnostics

This screen allows the installer to test all major communicating components of the system indoor unit (air handler or furnace), outdoor unit (air conditioner or heat pump) and zoning control (if applicable). Pressing the stop diagnostics button will pause the diagnostic function.

Touch the left arrow at the top left side of screen to return to the Dealer Control Center.

## Installation Report

The overview screen provides information on dealer and customer information. Also included under day of install section is information on conditions at the time of installation. Information includes date, time indoor and outdoor temperatures

and indoor humidity. Under equipment, system, indoor/outdoor and zoning model number, serial number and firmware information is displayed.

Other menu items include system indoor and outdoor units and zoning control parameter settings.

**NOTE:** *Installation Report is not available until after exiting the dealer control center following commissioning. Return to the dealer control center from the home screen to view the installation report.*

Results of both manual and automatic tests will be displayed under this section.

## Information

---

The dealer information screen will appear. The next screen will be for dealer information. Here either the dealer ID or phone number can be added. Once the system is connected to the Internet, the remaining information is automatically populated. Not all information for this screen will be viewable. Touch and hold and then drag up to access the remaining information on the screen.

Information Required: Dealer ID and / or dealer phone number. Information that can be manually entered is name, email website, dealer address which includes address 1, address 2, city state and zip/postal code. Once completed, touch the left arrow at the top left side of screen to return to the Dealer Control Center.

### **IMPORTANT**

Adding dealer information will ensure the thermostat is associated with your LennoxPros account when connecting to the Lennox server.

**Information Pop-Up Screen:** If the dealer ID or phone number is not provided, a warning screen will appear. The warning screen will provide information on the limitation imposed on the system if this information is missing. Touch no to return to the above screen to complete the information requested or press yes to continue.

### General Information

On this screen general information needs to be verified or changed. Touch any item to change its contents. A pop-up screen will appear that will allow the information to be added or changed.

Information Required:

1. Select desired language (ENGLISH, FRANÇAIS or ESPAÑOL).
2. Select country / region.
3. Select time and date which includes time, date, time zone, daylight savings time (ON/OFF)

4. Temperature unit (**Fahrenheit** or **Celsius**).
5. Once completed press **continue**.

### Home Address

On this screen general information needs to be verified or changed. Touch any line item to change its contents. Information to be added is address 1, address 2, state, city and zip/postal code.

Complete the requested information and press the continue button.

## Dehumidification Settings

For firmware version 3.15 and later, all controls for dehumidification are listed at **menu > settings > humidity**. Under **Humidity Control**, select **dehumidify** to enable dehumidification. By default it is **disabled**.

When dehumidify is enabled, the options are as follows and are dependent on equipment type and accessory installed.

### Dehumidification Setting Options

---

- **Normal** — Recommend when the air outside is not too humid.
  - **Max** —
    - » Single and Two-Stage Outdoor Units or Variable Capacity outdoor units without a Discharge Air Temperature Sensor (DATS) Installed. Recommend when outdoor air is excessively humid. May cool your home below the set temperature.
- NOTE:** *Recommend use of DATS catalog number 88K38 when variable capacity outdoor units are used.*
- » Variable Capacity Outdoor Units with DATS installed. Recommended when outdoor air is excessively humid. Adjusts cooling based on duct sensor data. May cool your home below the set temperature.
- **Climate IQ (Auto)** — Automatically adjusts fan speeds and cooling power based on local climate conditions, using Climate IQ technology. May cool your home below the set temperature.

### Overcooling

---

Slide bar adjust with a range of 0°F to 4°F (-17.8 to -15.5°C). Only available when Max or Climate IQ is selected.

### Dehumidification Set Point

---

Slide bar adjust with a range of 40% to 60%.

## Advanced Dehumidification Descriptions

See table 1 for detail information concerning system operations when using Normal, Max or Climate IQ settings.

**Table 16. Dehumidification Control Modes of Operations**

Mode of Operation	Option	Description
Dehumidification Only	Normal	Both Staged and Variable Capacity Outdoor Units: Dehumidifies while servicing a cooling demand and will not over cool. The overcooling slider is hidden from the user. Variable capacity units use the “comfort” table to run the system, regardless of the presence of a discharge air temperature sensor (DATS).
	Max	<p><b>Staged Outdoor Unit:</b> If at the start or during a cooling call, the humidity is above the relative humidity set point then the unit dehumidifies during the cooling demand. If at the time the cooling call terminates, the humidity demand is not satisfied, overcooling will occur up to the overcooling slider setting in an attempt to satisfy the dehumidification demand. Once the room temperature reaches the over cooling set point. If the system still has a dehumidification demand, the system keeps using the over cooling set point as its operating cooling set point (will not wait for the temperature to rise to the normal cooling set point to run again) until the dehumidification demand is satisfied</p> <p><b>Variable Capacity Outdoor Unit:</b> These units work as like staged units and if a discharge air temperature sensor (DATS) sensor is installed, the DAT PI setting is used to control the compressor speed to maintain a cold coil for optimized dehumidification. If a DATS is not installed, the system runs using the outdoor unit’s “comfort” tables during dehumidification.</p>
Dehumidification Only	Available only with Max and Climate IQ (Auto)	<p><b>Staged Outdoor Unit:</b> At the end of a cooling call, if the humidity is above the set point by a certain amount (Basic to Precision Threshold parameter), then overcooling to the overcooling slider setting occurs to satisfy the dehumidification demand. Once the room temperature reaches the overcooling set point, if the system still has a dehumidification demand, the system keeps using the over cooling set point as its operating cooling set point (will not wait for the temperature to rise to the normal cooling set point to run again) until the dehumidification demand is satisfied.</p>

**Table 16. Dehumidification Control Modes of Operations**

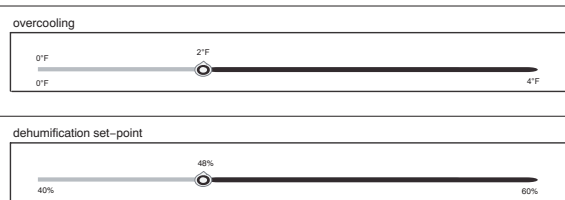
Mode of Operation	Option	Description
Dehumidification Only	Available only with Max and Climate IQ (Auto)	<p><b>Variable Capacity Outdoor Unit:</b> If at the start or during a cooling call, the humidity level is below the relative humidity set point by more than 10%, then the mode becomes “Dry” such that the blower CFM is increased to the “Dry” table setting.</p> <ul style="list-style-type: none"> <li>If a cooling call starts with the humidity level below the relative humidity setpoint, or if during a cooling call, the humidity level is between the dehumidify off relative humidity point and the relative humidity set point -10, then standard cooling runs to satisfy the cooling demand, without any added dehumidification.</li> <li>If at the start or during a cooling call, the humidity is above the relative humidity set point then the unit dehumidifies during the cooling demand. If at the time the cooling call terminates, the humidity is above the Basic to Precision Threshold then overcooling will occur up to the slider setting in an attempt to satisfy the dehumidification demand. Once the room temperature reaches the over cooling set point, if the system still has a dehumidification demand, the system keeps using the over cooling set point as its operating cooling set point (does not wait for the temperature to rise to the normal cooling set point to run again) until the dehumidification demand is satisfied.</li> <li>The Basic to Precision Threshold is a parameter with the following properties: Definition: Relative humidity amount above the relative humidity set point where over cooling will occur to dehumidify. Default: 4, Min: 0, Max: 10, Inc: 1</li> <li>Variable capacity units use the “comfort” table to run the system, regardless of the presence of a DATS.</li> </ul> 

1 Variable capacity outdoor units are XC20, XP20, XC25 and XP25. NOTE - The above information is applicable only for non-zoning systems, in addition to thermostat using firmware version 3.15 or later. There is no dehumidification capability in zoning systems.

## Displaying Outdoor Temperature (Sensor) and Indoor Humidity on the Home Screen

### Displaying the Outdoor Sensor Temperature on the Home Screen

An outdoor temperature sensor is provided in all iComfort outdoor units. To display the outdoor temperature on the home screen of the HD Display, you can enable this feature under the dealer control center. Use the following procedure to enable the outdoor temperature sensor display

1. Touch **menu** and then touch **settings**.
2. Touch **advanced settings** and then touch **view dealer control center**.
3. Touch **equipment** and then touch **thermostat**.
4. Touch **Outdoor Temperature** and touch **sensor**.
5. Touch the back arrow (<) at the top left-hand of the screen to return to the **dealer control center**.
6. Touch **exit**.
7. From the Home screen, touch **menu** and then touch **settings**.
8. Touch **display** and touch **outdoor temperature**.
9. Touch **sensor** to touch the outdoor sensor. Touch < display to return to display screen. There under outdoor temperature it will indicate sensor.
10. Touch the home icon at the top left-hand corner of the screen to return to the home screen.

### Displaying the Indoor Humidity on the Home Screen

To enable the Indoor Humidity Display on the Home screen use the following procedure:

1. Touch **menu** and then touch **settings**.
2. Touch **advanced settings** and then touch **view dealer control center**.
3. Touch **equipment** and then touch **thermostat**.
4. Touch **Display Indoor Humidity** and touch the toggle switch to turn on.
5. Touch the back arrow (<) at the top left-hand of the screen to return to the dealer control center.
6. Touch **exit** to return to the home screen.

## iHarmony Zoning

The damper control module is compatible with the following Lennox equipment:

- Lennox communicating variable speed or variable capacity (variable capacity) indoor and two-stage or variable capacity (modulating) outdoor units.

- Lennox communicating variable speed indoor unit and communicating or non-communicating (conventional) single-stage outdoor unit (two zones maximum supported).
- Lennox communicating variable speed indoor unit and communicating or non-communicating (conventional) two-stage outdoor unit (four zones maximum supported).
- Parameter settings are listed in “Table 12. Zoning Control Parameters” on page 40.
- Wiring connections are listed in “Figure 8. iComfort S30, Lennox Communicating Indoor and Outdoor Units, iHarmony Zoning System (Damper Control Module) and Zone Sensors” on page 9.

## PureAir S

The iComfort S30 Ultra Smart Thermostat will require firmware version 3.4 or higher to take advantage of all of the PureAir S features.

Features included are:

- 4-wire connection to Lennox communicating indoor unit control
- Using sensors to:
  - » Automatically detect dirty air filter
  - » Display air filter life percentage
  - » Monitor UVA lamp operational state (On or Off).
  - » Display UVA lamp life percentage
- Parameter settings are listed in “Table 14. PureAir S Parameters” on page 41.
- Applicable alarms for PureAir operations are listed in “Table 19. Alert Codes and Troubleshooting” on page 55.
- Wiring connections are listed in “Figure 12. Communicating Indoor Unit and PureAir S” on page 13.

## Ventilation (ERV, HRV and Fresh Air Damper)

This equipment is designed to provide fresh air while exhausting an equal amount of stale air.

### Ventilation Rates

The S30 ventilation function is only a turn on - turn off feature. All CFMs must be adjusted from the HRV/ERV unit. The ventilation function can be controlled by outdoor temperatures and by timers in the thermostat. The ventilation feature can also control 1 and 2 stages of ventilation operation.

Thermostat ventilation CFM parameters are to be adjusted only after the HRV/ERV set up is completed and the CFMs are known. Once the thermostat's CFMs are adjusted they are used with the thermostat's timer algorithm to determine how long to run the HRV/ERV and to change from low to high speed if a 2-stage HRV/ERVs.

### Energy Recovery Ventilator (ERV)

The ERV unit is equipped with an enthalpic core. This device is designed for use in warm, humid climates with heavy air conditioning loads. The ERV unit transfers both sensible (temperature) and latent (moisture) heat from incoming fresh air to the stale air as it is being exhausted; thus, reducing the air conditioning load.

### Heat Recovery Ventilator (HRV)

The HRV unit is equipped with an aluminum core. The device uses the stale air that is being exhausted to condition the fresh air as it is being brought in.

Lennox models are all non-communicating equipment and can be added during the commissioning procedure (see "Commissioning (Using the HD Display)" on page 19).

Parameter settings and descriptions are listed in "Table 6. Smart Hub Parameters" on page 23. The table below list which parameters are available for the Fresh Air Damper, ERV and HRV equipment.

### Fresh Air Damper

This option is used to control a damper connecting outside air to the return plenum of the system. When a fresh air damper style of ventilation is added to the system, and ventilation is required, the ventilation demand is serviced by energizing one relay to close or open the relay contacts connected to the fresh air damper and commanding the blower to run at a rate of at least the continuous fan speed.

The parameter Fresh Air Damper Ventilation CFM represents the CFM of the air drawn through the fresh air damper while the system runs the indoor blower at the continuous fan speed for non-zoned systems, and the lowest zone CFM (continuous fan, heating, or cooling) for zoned applications. All calculations used to determine the ventilation volume requirement and the amount of ventilation air delivered use this number regardless of the actual fan speed.

### Zoning Application

- When ventilation is demanded in zoned applications without conditioning calls, the fresh air damper will open and the blower will run at the lowest set zone CFM referred to above.

- Ventilation while a zone is being conditioned is serviced simply by opening the fresh air damper while the zone system conditions the zone.
- The system keeps track of the amount of ventilation delivered in the same manner as any single speed HRV or ERV.
- When the time required to satisfy the ventilation time requirement using the fresh air damper ventilation rate is greater than or equal to the time remaining in the ventilation time block, then ventilation is initiated and continues until the ventilation time requirement is satisfied.

### Operation of Fresh Air Dampers with Environmental Overrides

- When the Non-ASHRAE Compliant mode is selected (Timed), the system first checks for the outdoor temperature and dew point to be within the set parameter range before allowing ventilation to occur.
- When the ventilation changes states (on/off) due to an environmental override, it will remain in that state for a minimum of 10 minutes before again changing states due to an environmental override.
- Operation is otherwise the same as the ASHRAE compliant method.

### Wiring

Wiring connections are listed in "Figure 13. iComfort S30 with Ventilation (Fresh Air Damper, ERV and HRV)" on page 13.

### Ventilation Control Modes

Thermostat ventilation CFM parameters are to be adjusted only after the HRV/ERV set up is completed and the CFMs are known. Once the thermostat's CFMs are adjusted they are used with the thermostat's timer algorithm to determine how long to run the HRV/ERV and to change from low to high speed if a 2-stage HRV/ERVs.

**Table 17. Ventilation Control Modes**

Ventilation Control Mode	Fresh Air Damper	1 Speed HRV	2 Speed HRV	1 Speed ERV	2 Speed ERV
<b>Timed</b>					
Ventilation Minutes Per Hour (0 to 60 min., default is 20 min.)	X	X	X	X	X
Ventilation Rate (20 to 500 cfm, default is 130 cfm) (Shown only for single speed ERV or HRV)	X	X		X	
Ventilation Rate for Low Speed (10 to 200 cfm, default is 50 cfm) (Shown only for two speed ERV or HRV)			X		X

**Table 17. Ventilation Control Modes**

Ventilation Control Mode	Fresh Air Damper	1 Speed HRV	2 Speed HRV	1 Speed ERV	2 Speed ERV
Ventilation Rate for High Speed (20 to 500 cfm, default is 130 cfm) (Shown only for two speed ERV or HRV)			X		X
Ventilation High Outdoor Temperature Limit (60 to 115°F, default is 100°F)	X	X	X	X	X
Ventilation Low Outdoor Temperature Limit (-20 to 55°F, default is 0°F)	X	X	X	X	X
Ventilation High Outdoor Dew Point Limit (45 to 80°F, default is 55°F)	X	X	X	X	X

**ASHRAE (62.2)**

**NOTE:** In this mode the thermostat can assist the installer by validating the ventilation CFMs are capable of meeting the ASHRAE required ventilation volumes, but the thermostat has no ability to control CFM from the HRV/ERV.

Ventilation Rate (20 to 500 cfm, default is 130 cfm)	X	X		X	
Ventilation Rate for Low Speed (10 to 200 cfm, default is 50 cfm)			X		X
Ventilation Rate for High Speed (20 to 500 cfm, default is 130 cfm)			X		X
ASHRAE Compliance Check	NO	YES	YES	YES	YES
ASHRAE Infiltration Credit (0 to 200 cfm, default is 0 cfm)	X	X	X	X	X
ASHRAE House Floor Area Serviced by this Ventilator	X	X	X	X	X
ASHRAE Number of Bedrooms	X	X	X	X	X

**Ventilation Outdoor Condition Override - Enabled**

Ventilation High Outdoor Temperature Limit (60 to 115°F, default is 100°F)	X	X	X	X	X
Ventilation Low Outdoor Temperature Limit (-20 to 55°F, default is 0°F)	X	X	X	X	X
Ventilation High Outdoor Dew Point Limit (45 to 80°F, default is 55°F)	X	X	X	X	X

**Communicating System Configurations**

**Furnace and Air Conditioner**

An communicating gas furnace (G71MPP, EL296V, SLP98 or SL280) with an communicating air conditioner (SL18XC, XC17, XC20, XC21 or XC25 only) unit.

1. Wiring — See “Application Wiring” on page 7 and “Application Wiring” on page 7.
2. DO NOT cut any option links on furnace control.
3. After the entire system is wired, power up the system; the thermostat will check the system for installed communication devices.
4. During commissioning, you will end that process with the **dealer control center** screen. From there touch **equipment** to modified any system or equipment settings.
5. From the equipment list, touch **furnace**. From this furnace screen you will have access to the various airflow settings. Set the system air volumes according to the needs of the home.
6. When all CFM settings are complete, press the back arrow (<) at the top left-hand of the screen to return to the dealer control center. Touch **tests** to access the test section.
7. Here you will have another opportunity to adjust blower circulation, heating and cooling circulation air flows. Use the plus or minus buttons to adjust up or down the CFM settings. Once adjustments are completed, touch **continue**.
8. Under the **test to run**, you may un-check any test not desired, or run all tests. Touch **start tests** to proceed. Once each test section is completed, touch **continue** to proceed to the next group of tests.
9. Once all tests are completed, touch done which will return you to the **select test to run** screen. If finish, touch the back arrow (<) at the top left-hand of the screen to return to the **dealer control center**.
10. Touch exit to return to the home screen.

**Furnace and HP Unit (Dual-Fuel)**

An communicating gas furnace (G71MPP, EL296V, SLP98 or SL280) with an communicating heat pump (SL18XP, XP20, XP21 or XP25 only) unit.

1. Wiring — See “Terminals and Wiring Recommendations” on page 5 and “Application Wiring” on page 7.
2. DO NOT cut any option links on furnace control.
3. After the entire system is wired, power up the system; the thermostat will check the system for installed communication devices.
4. During commissioning, you will end that process with the **dealer control center** screen. From there touch **equipment** to modify any system or equipment settings.
5. Select Balance Point Control and press edit. Use the down arrow to touch Enabled. A pop-up warning screen indicating that due to enabling **Balance Point Control** other related parameter values were automatically changed.

6. Complete **Balance Point Control** by editing the **High** and **Low Balance Points**. It is not necessary to change the defaults.
  7. From the equipment list, press **furnace**. From this furnace screen you will have access to the various airflow settings. Set the system air volumes according to the needs of the home.
  8. When all CFM settings are complete, touch the back arrow (<) at the top left-hand of the screen to return to the dealer control center. Touch **tests** to access the test section.
  9. Here you will have another opportunity to adjust blower circulation, heating and cooling circulation air flows. Use the plus or minus buttons to adjust up or down the CFM settings. Once adjustments are completed, touch **continue**.
  10. Under the **select test to run screen**, you may un-check any test not required, or run all tests. Touch **start tests** to proceed. Once each test section is completed, touch **continue** to proceed to the next group of tests.
  11. Once all tests are completed, touch **done**. This will return you to the touch tests to run screen. If finish, touch the back arrow (<) at the top left-hand of the screen to return to the **dealer control center**.
  12. Touch **exit** to return to the home screen.
7. When all CFM settings are complete, touch the back arrow (<) at the top left-hand of the screen to return to the **dealer control center**.
  8. Touch **tests** to access the test section.
  9. Here you will have another opportunity to adjust blower circulation, heating and cooling circulation air flows. Use the plus or minus buttons to adjust up or down the CFM settings. Once adjustments are completed, press continue.
  10. Under the **select test to run** screen, you may un-check any test not required, or run all tests. Touch **start tests** to proceed. Once each test section is completed, touch **continue** to proceed to the next group of tests.
  11. Once all tests are completed, press done. This will return you to the touch tests to run screen. If finish, press the back arrow (<) at the top left-hand of the screen to return to the **dealer control center**.
  12. Touch **exit** to return to the home screen.

### TIPS

If the thermostat's **select mode** screen does not offer a choice for "emerg. heat" then it may be possible that the electric heat is not working or perhaps the electric heat has not been configured.

Configure the electric heat as described "Lennox Communicating Air Handler Electric Heat Configuration" on page 16, or for complete detail, see the air handler installation instruction. After confirming that the electric heat has been configured correctly, reconfigure the iComfort system by going to **menu > system > advanced settings > view dealer control center > equipment > reset > re-configure system**.

## Air Handler and Air Conditioner

An communicating air handler (CBX32MV, CBA38MV, or CBX40UHV) with an communicating air conditioner (SL18XC, XC17, XC20, XC21 or XC25).

### IMPORTANT

Be sure to configure the air handler control so that heat strips (if used) information will be detected by the thermostat. This must be done prior to powering up the system and control system.

1. Configure air handler control (AHC) for auxiliary heat strips if used.
2. Wiring — See "Terminals and Wiring Recommendations" on page 5 and "Application Wiring" on page 7. .
3. DO NOT cut any option link on air handler control.
4. After the entire system is wired, power up the system; the thermostat will check the system for installed communication devices.
5. During commissioning, you will end that process with the **dealer control center** screen. From there touch **equipment** to modify any system or equipment settings.
6. From the equipment list, touch **air handler**. From this air handler screen you will have access to the various airflow settings. Set the system air volumes according to the needs of the home.

## Air Handler and Heat Pump Unit

An communicating air handler (CBX32MV, CBA38MV, or CBX40UHV) with an communicating heat pump (SL18XP, XP17, XP20, XP21 or XP25) unit.

### IMPORTANT

Be sure to configure the air handler control so that heat strips (if used) information will be detected by the thermostat. This must be done prior to powering up the system and control system.

1. Configure air handler control (AHC) for auxiliary heat strips if used.
1. Wiring — See "Terminals and Wiring Recommendations" on page 5 and "Application Wiring" on page 7.
2. DO NOT cut any option link on air handler control.
3. After the entire system is wired, power up the system; the thermostat will check the system for installed communication devices.



4. During commissioning you will end that process with the **dealer control center** screen. From there touch **equipment** to modified any system or equipment settings.
5. Select **Balance Point Control** and touch **edit**. Use the down arrow to touch Enabled. A pop-up warning screen indicating that due to enabling Balance Point Control other related parameter values were automatically changed.
6. Complete **Balance Point Control** by editing the **High** and **Low Balance Points**. It is not necessary to change the defaults.
7. From the equipment list, touch **air handler**. From this air handler screen you will have access to the various airflow settings. Set the system air volumes according to the needs of the home.
8. When all CFM settings are complete, touch the back arrow (<) at the top left-hand of the screen to return to the **dealer control center**. Touch **tests** to access the test section.
9. Here you will have the opportunity to adjust blower circulation, heating and cooling circulation air flows. Use the plus or minus buttons to adjust up or down the CFM settings. Once adjustments are completed, touch **continue**.
10. Under the **select test to run** screen, you may un-check any test not required, or run all tests. Touch **start tests** to proceed. Once each test section is completed, touch **continue** to proceed to the next group of tests.
11. Once all tests are completed, touch **done**. This will return you to the **select tests to run** screen. If finish, touch the back arrow (<) at the top left-hand of the screen to return to the **dealer control center**.
12. Touch **exit** to return to the home screen.
5. From the add/remove equipment screen, touch either **1 Stage A/C unit** or **2 Stage A/C unit**.
6. Touch **done** to return to the **equipment found** screen.
7. Touch **continue** to proceed to the next screen.
8. From the equipment list, touch **Furnace**. From this furnace screen you will have access to the various airflow settings. Set the system air volumes according to the needs of the home.
9. Continue with the commissioning sequence. When the **set up airflow per zone** screen appears you can adjust the blower, heating and cooling circulation air flows per zone. When done, touch **continue** to proceed.
10. The **dealer control center** will appear. Touch **tests** to access the test section.
11. Here you will have the opportunity to adjust blower circulation, heating and cooling circulation air flows. Use the plus or minus buttons to adjust up or down the CFM settings. Once adjustments are completed, press **continue**.
12. Under the **select test to run** screen, you may un-check any tests not required, or run all tests. Touch **start tests** to proceed. Once each test section is completed, touch **continue** to proceed to the next group of tests.
13. Once all tests are completed, touch **done**. This will return you to the touch tests to run screen. If finish, touch the back arrow (<) at the top left-hand of the screen to return to the **dealer control center**.
14. Touch **exit** to return to the home screen.

#### TIPS

If the thermostat's **select mode** screen has only **heat only** or **off** selections and no choice for cooling or heat/cool you must add the non-communicating air conditioning unit. Use the following procedures from the home screen to add a non-communicating air conditioner.

1. Select **menu > settings > advance settings > view dealer control center > equipment**.
2. Select either **1-Stage A/C** or **2-Stage A/C**. Touch the back arrow (<) at the top left-hand of the screen to return to the dealer control center.
3. Touch **exit** to return to the home screen.

On two-stage air conditioners you must cut the **W915 2 Stage Compr** link on the furnace control

#### Communicating Furnace and Conventional Heat Pump Unit (Dual

## Hybrid System Configurations

### Communicating Furnace and Conventional Air Conditioner

An communicating furnace (G71MPP, EL296V, SLP98 and SL280) with a conventional non-communicating Lennox brand air conditioner.

1. Wiring — See “Terminals and Wiring Recommendations” on page 5 and “Application Wiring” on page 7.
2. Cut option link **2-stage compr** (Y1 to Y2, W915) on furnace control on two-stage Lennox brand conventional air conditioner units only.
3. After the entire system is wired, power up the system; the thermostat will check the system for installed communication devices.
4. During commissioning you will arrive at the **equipment found** screen. From there touch **non-communicating equipment** to add non-communicating equipment.

## Fuel)

If using a conventional non-communicating heat pump unit in an iComfort dual-fuel system then a iComfort Equipment Interface Module must be used and set up as a communicating heat pump.

If the HD Display System Setting only shows “heat only“ or “off“ choices and does not offer a choice for “cooling“ you must “Install“ the non-communicating air conditioning unit (see procedures above).

For two-stage air conditioners you must cut the **Y1-Y2 2-stage comp** on-board clippable link on the air handler control.

## Communicating Air Handler and Conventional Air Conditioner

An communicating air handler (CBX32MV or CBX40UHV) with a conventional non-communicating Lennox brand air conditioner unit.

### **IMPORTANT**

Be sure to configure the air handler control so that heat strips (if used) information will be detected by the thermostat. This must be done prior to powering up the system and control system.

1. Configure air handler control (AHC) for auxiliary heat strips if used.
2. Wiring — See “Terminals and Wiring Recommendations” on page 5 and “Application Wiring” on page 7.
3. On air handler control, when matched with conventional Lennox brand 2-stage air conditioner, cut the **Y1-Y2 2-stage comp** on-board clippable link.
4. On air handler control, remove jumper between W1 and W2 for two-stage electric heat only.
5. After the entire system is wired, power up the system; the thermostat will check the system for installed communication devices.
6. During commissioning you will arrive at the **equipment found screen**. From there touch **non-communicating equipment** to add non-communicating equipment.
7. From the **add/remove equipment** screen, touch either **1-Stage A/C unit** or **2-Stage A/C unit**.
8. Touch the **done** to return to the **equipment found** screen.
9. Touch **continue** to proceed to the next screen.
10. Continue with the installer setup sequence. When the set up airflow per zone screen appears you can adjust blower, heating and cooling circulation air flows. When done, press **continue** to proceed.

11. The dealer control center will appear. Touch **tests** to access the test section.
12. Here you will have another opportunity to adjust blower circulation, heating and cooling circulation air flows. Use the plus or minus buttons to adjust up or down the CFM settings. Once adjustments are completed, touch **continue**.
13. Under the touch test to run screen, you may un-check any tests not required, or run all tests. Touch **start tests** to proceed. Once each test section is completed, touch **continue** to proceed to the next group of tests.
14. Once all test are completed, touch **done**. The will return you to the **select tests to run** screen. If finish, touch the back arrow (<) at the top left-hand of the screen to return to the **dealer control center**.
15. Touch **exit** to return to the home screen.

### TIPS

If the thermostat’s **select mode** screen does not offer a choice for “emergency heat” then it may be possible that the electric heat is not working or perhaps the electric heat has not been configured.

Configure the electric heat as described “Lennox Communicating Air Handler Electric Heat Configuration” on page 16, or for complete detail, see the air handler installation instruction. After confirming that the electric heat has been configured correctly, reconfigure the iComfort system by going to **menu > system > advanced settings > view dealer control center > equipment > reset > re-configure system**.

## Communicating Air Handler and Conventional Heat Pump Unit

An communicating air handler (CBX32MV, CBA38MV, or CBX40UHV) with a conventional non-communicating Lennox brand heat pump unit.

### **IMPORTANT**

Be sure to configure the air handler control so that heat strips (if used) information will be detected by the thermostat. This must be done prior to powering up the system and control system.

1. Configure air handler control (AHC) for auxiliary heat strips if used.
2. Wiring — See “Terminals and Wiring Recommendations” on page 5 and “Application Wiring” on page 7.
3. On air handler control:
  - When matched with conventional Lennox brand 2-stage heat pump, cut the **Y1-Y2 2-stage comp** on-board clippable link.
  - Remove jumper between W1 and W2 for two-stage electric heat only.

- Cut on-board R-O clippable link.
4. After the entire system is wired, energized the system and the thermostat will check the system for installed communication devices.
  5. During commissioning you will arrive at the **equipment found** screen. From there touch **non-communicating equipment** to add non-communicating equipment.
  6. From the **add/remove equipment** screen touch the **Outdoor Unit Type** from the device list (**1-stage HP** or **2-stage HP**) and touch **done** to return to the **equipment found** screen.
  7. Touch **continue** to proceed to the next screen.
  8. Continue with the commissioning sequence until you reach the **dealer control center**. Touch **equipment** to continue.
  9. Touch **air handler** from the list. From this **air handler** screen you will have access to the various airflow settings. Set the system air volumes according to the needs of the home. When all CFM settings are complete, touch the **back** button.
  10. Test the system operation and confirm the system is electrically energized and operational. Test the heat strips (when used) to insure the auxiliary stages operates as designed.
  11. Touch **done**.
  12. Exit the **dealer control center** by touching **exit** to return to the home screen.

## Equipment Interface Module

The Equipment Interface Module (EIM) can be configured in the following setups:

- Thermostat, EIM with either a non-communicating (conventional) indoor unit and iComfort outdoor unit.
  - Thermostat, EIM with either a non-communicating (conventional) indoor unit and outdoor unit.
  - Thermostat, iComfort furnace, EIM and a non-communicating heat pump.
1. Wiring — See “Terminals and Wiring Recommendations” on page 5 and “Application Wiring” on page 7.
  2. DO NOT cut any option link on furnace control.
  3. After the entire system is wired, power up the system; the thermostat will check the system for installed communication devices.
  4. During commissioning you will arrive at the **equipment found** screen. From there touch **non-communicating equipment** to add non-communicating equipment.

5. From the **add/remove equipment** screen, touch either **1-Stage A/C unit** or **2-Stage A/C unit**.
6. Touch the **done** to return to the **equipment found** screen. Touch **continue** to proceed to the next screen.
7. Continue with the commissioning sequence. When the **set up airflow per zone** screen appears, you can adjust blower, heating and cooling circulation air flows. When done, touch **continue** to proceed.
8. The **dealer control center** will appear next. Touch **tests** to access the test section
9. Here you will have another opportunity to adjust blower circulation, heating and cooling circulation air flows. Use the plus or minus buttons to adjust up or down the CFM settings. Once adjustments are completed, press **continue**.
10. Under the **select test to run** screen, you may un-check any tests not required, or run all tests. Touch **start tests** to proceed. Once each test section is completed, touch **continue** to proceed to the next group of tests.
11. Once all test are completed, touch **done**. This will return you to the **select tests to run** screen. If finish, press the back arrow (<) at the top left-hand of the screen to return to the **dealer control center**.
12. Touch **exit** to return to the home screen.

## SLP98V Variable Capacity Furnace Default Setting

If your thermostat is being used with a SLP98V furnace and parameter **Gas Heat Control Mode** will default to **Load-Tracking Variable Capacity**. With this unit the system’s settings for stage timers and temperature differentials are ignored (even if shown enabled in the thermostat).

The stage timer will be used on the cooling side for other cooling units except when variable capacity outdoor units are used. The furnace software sets and controls the firing rates. Further details concerning Gas Heat Control Mode settings are listed in “Table 6. Smart Hub Parameters” on page 23.

## Wi-Fi Connection

This is for connecting the thermostat to a secure home wireless network.

**NOTE:** A router with Bonjour capabilities is required for this function. Check the router functions if smart hub do not connect. Apple Bonjour® is an implementation of zero-configuration networking (Zeroconf), a group of technologies that includes service discovery, address assignment, and host name resolution.

**NOTE:** Never use a home guest account. Never use an open router connection (non-secure). Always use a secure connection physically located in

the home where the thermostat is located.

### Home Wi-Fi Access Point is Visible

1. Go to **menu > settings > wi-fi** ,
2. Slide the option to **ON** to enable Wi-Fi.
3. Wi-Fi network will show **not connected**. Press on **not connected** to display a list of available access points.
4. Select a network will be displayed listing all detected networks within range. Select your home network by pressing on the network name.

**NOTE:** The thermostat can connect to a home wireless router that uses up to 32 characters in the access point name (visible or hidden).

5. When connecting to a secure home Wi-Fi network, a password will be requested. Enter your home Wi-Fi network password and press join to continue.

**NOTE:** If you wish to see the characters you are typing, check show password. The thermostat will support up to a 63 character password. The password cannot contain the % or # symbols.

### Home Wi-Fi Access Point is Hidden

1. Slide the option to **ON** to enable Wi-Fi.
2. Wi-Fi network will show not connected. Press on **“not connected”**.
3. Scroll down and select **other**.
4. The **“enter new network information”** screen will appear. Enter the name of the hidden network.

**NOTE:** The thermostat can connect to a home wireless router that uses up to 32 characters in the access point name (visible or hidden). DO NOT connect to a guest access point.

5. Select Security. Options are: none, WEP, WPA and WPA2. If your home Wi-Fi connection is unsecured, then Wi-Fi security must be enabled using WEP, WPA or WPA2 via the router before proceeding. Consult your router documentation on how to enable Wi-Fi security.
6. Once security type is selected, a password field will appear. Enter the password to access your home Wi-Fi network.

**NOTE:** If you wish to see the characters you are typing, check show password. The thermostat will support up to a 63 character password.

7. Press **join**.

Whether connecting to a visible or hidden network, if successful, a check mark will appear above both the router and Internet icons.

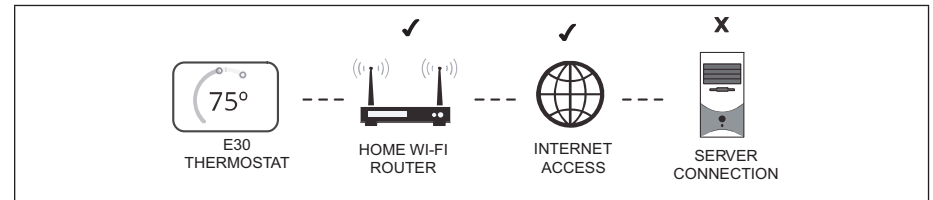

**Figure 21. Connection Status**  
**Troubleshooting Wi-Fi Connection**

The following terminology is used in this troubleshooting section:

- Received Signal Strength Indication (RSSI). This indicates the signal strength of the Wi-Fi router being received by the scanning device (i.e., smart phone). So the higher the RSSI number (or less negative in some devices), the stronger the signal.
- Wireless networks supported by this system are:
  - » 802.11b is 2.4Ghz band (max 11 Mbit/s)
  - » 802.11g is 2.4Ghz band (max 54 Mbit/s)
  - » 802.11n is 2.4Ghz band (max 130 Mbit/s)
- Internet Protocol Address (IP address). This is an address assigned by your home router for each network device (e.g., computer, printer, thermostat).

**Electromagnetic Interference Causing Poor Connectivity:** Locate the smart hub and router away from other devices that could possibly interfere with wireless communications. Some examples of other devices that could interfere are:

- Microwave ovens
- Wireless cameras
- Portable phones and bases
- Baby monitors
- Wireless speakers
- Bluetooth devices
- Garage door openers
- Neighbor’s wireless devices

To eliminate a possible source of interference, temporarily disable any devices and see if Wi-Fi performance has improved.

### Received Signal Strength Indication (RSSI)

The ideal signal strength range for the thermostat is -1 to -69 RSSI. The signal strength can be viewed from the thermostat interface.

1. Press **NETWORK SETTINGS**; this screen shows a graphical view of

buttons representing OPEN and SECURE wireless networks, along with button for adding a network.

2. Select the access point that has already been established and connected. When selecting the info icon, a screen will appear which will display an option to forget the network and IP address assigned to the thermostat by your router, sub-net mask, router, DNS and RSSI. If the RSSI signal strength is anywhere between -9 to -69, then the signal strength is sufficient. If outside this range, then either relocate the router closer to the thermostat, add a repeater, or move the smart hub. Adjusting antenna on router and/or smart hub may resolve the issue.

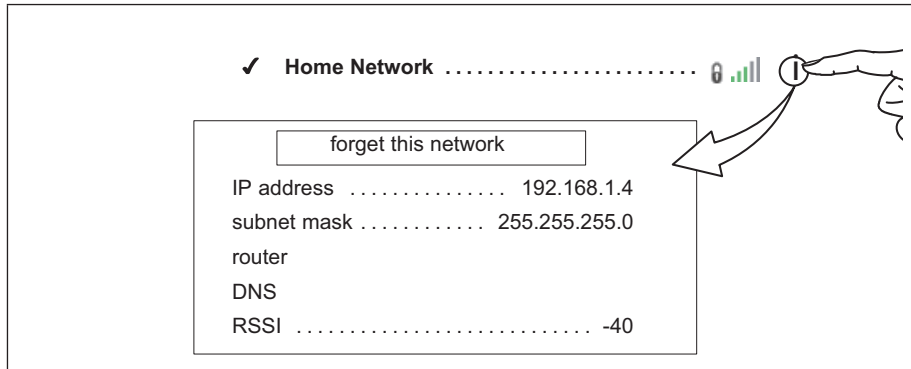

Figure 22. Verifying Signal Strength

## Performance Reports

Performance reports are only available through either the consumer or dealer web portals.

- Homeowner access is available at [www.myiComfort.com](http://www.myiComfort.com).
- Dealer access is available through the Dealer Dashboard at [www.LennoxPros.com](http://www.LennoxPros.com).

More information concerning Performance Reports is available in the user guide.

## Mobile Applications

### iComfort Thermostat App (Homeowner)

- The free iComfort Thermostat app is available for use on iPhone®, iPad® and Android™ devices.
- Control cooling/heating temperatures, fan operation, set programs and set Away mode for multiple locations.

- Controls individual zone settings if system is equipped with the optional iHarmony® Zoning System.
- Controls PureAir S Air Purification System
- Controls fresh air dampers and ERV/HRV when connected to ACC1 and ACC2 terminals.

### iComfort Mobile Setup App (Installer)

- The free iComfort Setup app allows the installer to commission and service the system on any iPhone®, iPad® and Android™ device.
- Remotely turn the system on and off during setup.

Apple, the Apple logo, iPhone and iPad are trademarks of Apple Inc. registered in the US and other countries.

Android is a trademark of Google Inc. Use of this trademark is subject to Google permission.

## Notifications (Service and Alert Codes)

These screens provide information on active notifications and previously cleared notifications. When selecting either a cleared or active notification a brief description and alert code will be displayed. Notifications are categorized by system, indoor unit (air handler or furnace), outdoor unit (air conditioner or heat pump), zoning control (if installed) and thermostat.

### Alert Code Types

To expand a specification notification to access a more detail description of the alert code, press the down arrow to expand the description.

- **Critical** alerts are displayed on Home (user) screen under the homeowner and installer alert buttons. Critical means that a service call is needed to get the system running.
- **Moderate** means that the system will likely recover on its own and no interaction is necessary. Typically, either after a specific timer period or a specific number of instances, some moderate alerts will escalate to critical. Moderate alerts are found only in under the installer alert button.
- **Minor** is information only and helps Lennox interpret test results and understand complicated behaviors. Minors are not reported to homeowner or dealer.

**NOTE: Communication System:** When communication controls are operating in a communication system, all jumpers and links setting on the controls are ignored. Jumpers and links setting are treated as defaults and would only be active if the system was configured as a non-communicating system.

## Soft Disable

Soft disabling is when the Lennox communicating thermostat finds an unknown control on the communicating system communication bus. The thermostat sends the unknown control a message to go into soft disable mode until the component is properly configured or removed.

Sometimes soft disable will occur when a control is being replaced. Reconfiguring the system should resolve this issue.

The Lennox communicating thermostat will not show a alert code for a soft disabled control. When soft disabling occurs only the control that has been disabled will display the blinking LED status or seven-segment display indicator. Refer to the device's installation and setup guide for further guidance.

The iComfort control with the soft disable state will indicate so as follows:

- On air handler, integrated furnace and outdoor controls, the soft disable state is display by double horizontal lines on seven segment display.
- On iHarmony damper control module and EIM the green LED will blink 3 seconds on and 1 second off.

### **Possible Cause**

- Soft disable may occur when a control has been replaced. Reconfiguring the system should resolve this issue.
- Sometimes Lennox communicating thermostat detects a new device or an existing device or a device on the system that is not communicating with the thermostat. If this occurs, an alert code 10 is activated and the thermostat sends a soft disable command to the offending device on the communications bus (outdoor control, IFC, AHC, EIM, or damper control module).

### **Re-Configure System**

Use the following procedure if any controls are displaying the soft disable indicator:

1. Confirm proper wiring between all devices such as thermostat and smart hub.
2. Cycle power.
3. Go to the **menu > settings > advanced settings > view dealer control center**. Touch **proceed** to continue.
4. Select **equipment**.
5. Touch **reset**.
6. Touch **re-configure** system.
7. Select **confirm** to continue.
8. The thermostat will reboot and start through the system commissioning procedure.

## Service Notification Codes

The following are service notification alert codes.

**Table 18. Service Alert Notification Codes**

Service Alert Code	Function
3000	Filter 1
3001	Filter 2
3002	Humidifier pad
3003	UV Light
3004	Maintenance
3005	PureAir Maintenance
4000	User Wi-Fi state change, disabled
4001	Firmware download failed
4002	Image file download failed

Table 19. Alert Codes and Troubleshooting

Initial notification of critical alerts will pop-up on the home screen and will be listed under notification menu. Minor and moderate alerts are found only under the notification menu. Moderate alerts are not e-mailed to Homeowners. Dealers will get an email and code can be seen on thermostat under the installer notification section.

**NOTE:** Anytime the word **DEVICE** or **DEVICE2** is used in this table, it will be replaced on all alert code notification screens with the actual offending device name, for example, thermostat, heat pump, etc.).

Alert Code	Inverter Flash Code	Priority Condition	Applicable Component	Actual Displayed Alert Text	Component or System Operational State and Troubleshooting Tip
10		Critical	All communicating components	Unknown Device Detected - DEVICE2	<p>The thermostat when NOT in commissioning mode has detected an unknown device. Typically the thermostat will send a command to the unknown device and place the device into a soft disable state. The soft disable control will be indicated as follows:</p> <ul style="list-style-type: none"> <li>On air handler, furnace and outdoor controls, the soft-disabled state is displayed by double horizontal lines on seven-segment display.</li> <li>On the iHarmony control and equipment interface modules, the green LED will flash 3 seconds on and 1 second off.</li> <li>A new communicating device has been added to the system since the last commissioning setup was completed.</li> <li>Go to menu &gt; settings &gt; advanced settings &gt; view dealer control center &gt; equipment and press re-configure system. This will allow the system to auto-detect any new Lennox communicating devices attached.</li> <li>Clear alert code by reconfiguring the system.</li> </ul>
11		Critical	All communicating components	Missing DEVICE2	<p>The thermostat cannot find a previously installed system component.</p> <ul style="list-style-type: none"> <li>Check all system components (devices) connection wiring.</li> <li>Cycle system power.</li> <li>Go to menu &gt; settings &gt; advanced settings &gt; view dealer control center &gt; equipment and press re-configure system. This will allow the system to auto-detect any new Lennox communicating devices attached.</li> <li>Cycle system power, and If problem persists then clear by reconfiguring the system.</li> </ul>
12		Critical	Indoor Unit	Incomplete System	<p>Thermostat did not detect a communicating indoor unit.</p> <ul style="list-style-type: none"> <li>Check for voltage and missing components.</li> <li>Check R, i+, i- and C connections at subbase, smart hub and all attached communicating components.</li> <li>Ohm wires for electrical continuity.</li> <li>Cycle power to both indoor unit first and then thermostat.</li> <li>Verify that equipment interface module (if applicable) is configured as either an air handler or furnace when used with a non-communicating indoor unit.</li> <li>Go to <b>menu &gt; settings &gt; advanced settings &gt; view dealer control center &gt; equipment</b> and press <b>re-configure system</b>. This will allow the system to auto-detect any new Lennox communicating devices attached.</li> <li>Replace indoor unit control if there is no response.</li> <li>Automatically clears when the system detects that the issue no longer exists.</li> </ul>
13		Critical	Duplicate Equipment	Duplicate Comfort Sensor ID	<p>Thermostat found more than one indoor, outdoor unit or thermostat connected to the system. Thermostat will display the message "Too Many Devices of the Same Type".</p> <ul style="list-style-type: none"> <li>Check wiring and remove duplicate equipment.</li> <li>Go to <b>menu &gt; settings &gt; advanced settings &gt; view dealer control center &gt; equipment</b> and press <b>re-configure system</b>. This will allow the system to auto-detect any new Lennox communicating devices attached.</li> <li>Automatically clears when the system detects that the issue no longer exists.</li> </ul>

**Table 19. Alert Codes and Troubleshooting**

Initial notification of critical alerts will pop-up on the home screen and will be listed under notification menu. Minor and moderate alerts are found only under the notification menu. Moderate alerts are not e-mailed to Homeowners. Dealers will get an email and code can be seen on thermostat under the installer notification section.

**NOTE:** Anytime the word **DEVICE** or **DEVICE2** is used in this table, it will be replaced on all alert code notification screens with the actual offending device name, for example, thermostat, heat pump, etc.).

Alert Code	Inverter Flash Code	Priority Condition	Applicable Component	Actual Displayed Alert Text	Component or System Operational State and Troubleshooting Tip
14		Critical	Duplicate Equipment	Too Many Devices of the Same Type	<p>The thermostat found more than one thermostat, indoor or outdoor unit on the system.</p> <ul style="list-style-type: none"> <li>• Check wiring and remove duplicate equipment.</li> <li>• Go to <b>menu &gt; settings &gt; advanced settings &gt; view dealer control center &gt; equipment</b> and press <b>re-configure system</b>. This will allow the system to auto-detect any new Lennox communicating devices attached.</li> <li>• Automatically clears when the system detects that the issue no longer exists.</li> </ul>
29		Critical	HD Display (Thermostat)	Over Temperature Protection	<p>The thermostat is reading an indoor temperature that is higher than 90°F (factory default). The thermostat will not allow any heating operation to begin until it senses an indoor temperature lower than 90°F. Indoor temperature rose above 90°F during a heating demand.</p> <ul style="list-style-type: none"> <li>• Heating operation is not allowed.</li> <li>• Check to ensure that heating equipment is not stuck ON (reversing valve, etc.)</li> <li>• Check the accuracy of the thermostat temperature sensor.</li> <li>• Select cooling system mode to cool the indoor space below 90°F.</li> <li>• Automatically clears when the system detects that the issue no longer exists.</li> </ul>
30		Moderate	HD Display (Thermostat)	Low Temperature Protection	<p>The thermostat will not allow any cooling operation to begin until it senses a temperature higher than 40°F.</p> <ul style="list-style-type: none"> <li>• Cooling operation is not allowed.</li> <li>• Check to ensure that cooling equipment is not stuck ON.</li> <li>• Check accuracy of the thermostat temperature sensor.</li> <li>• Select heating system mode to heat the indoor space to above 40°F.</li> <li>• Automatically clears when the system detects that the issue no longer exists.</li> </ul>
31		Critical	Any Failed Communicating Component	Lost communication with DEVICE2	<p>The applicable system component (indoor unit, equipment interface or iHarmony control module or outdoor unit) has not communicated with thermostat for more than three minutes.</p> <ul style="list-style-type: none"> <li>• Check connections and voltages.</li> <li>• Ohm wires for electrical continuity.</li> <li>• If float switch is installed on air handler drain pan, check condensate line to ensure it is not clogged and tripping the float switch connected in series with <b>R</b> terminal.</li> <li>• Check to see if freezestat is installed.</li> <li>• If fault persists, then cycle power.</li> <li>• Fault clears after communication is restored.</li> </ul>



**Table 19. Alert Codes and Troubleshooting**

Initial notification of critical alerts will pop-up on the home screen and will be listed under notification menu. Minor and moderate alerts are found only under the notification menu. Moderate alerts are not e-mailed to Homeowners. Dealers will get an email and code can be seen on thermostat under the installer notification section.

**NOTE:** Anytime the word **DEVICE** or **DEVICE2** is used in this table, it will be replaced on all alert code notification screens with the actual offending device name, for example, thermostat, heat pump, etc.).

Alert Code	Inverter Flash Code	Priority Condition	Applicable Component	Actual Displayed Alert Text	Component or System Operational State and Troubleshooting Tip
32		Moderate	Any malfunctioning communicating component	Asynchronous Reset DEVICE2	<p>The applicable system component (device) is resetting itself. This issue may occur during a power outage or fluctuation. If persistent or if it coincides with the system operations then proceed with the following troubleshooting steps.</p> <ul style="list-style-type: none"> <li>• Check the power connections.</li> <li>• Check the amperage draw at the transformer (possible overloaded).</li> <li>• Check 24VAC voltage at the system component (device).</li> <li>• If the fault persists after checking the connections, replace the applicable control.</li> <li>• To clear the alert code, go to <b>menu &gt; settings &gt; advanced settings &gt; view dealer control center &gt; notifications</b> and select the alert code and press the <b>clear</b> button.</li> </ul>
34		Critical	Indoor or outdoor unit	Must Program Unit Capacity for DEVICE2	<p>The thermostat does not know the capacity (tonnage) of the indoor or outdoor unit. The applicable system component is missing the programmed unit capacity.</p> <ul style="list-style-type: none"> <li>• Remove power to thermostat before programming the unit control.</li> <li>• Go to applicable unit control and program the unit capacity manually (see the unit installation instruction for configuration instructions).</li> <li>• Once configuration is complete then reconnect thermostat wires.</li> <li>• Go to <b>menu &gt; settings &gt; advanced settings &gt; view dealer control center &gt; equipment</b> and press <b>reset all equipment</b>. This will allow the system to auto-detect any Lennox communicating components attached.</li> <li>• Automatically clears when the system detects that the issue no longer exists.</li> </ul>
35		Critical	All communicating components	(Incorrect Operation of DEVICE 2)	<ul style="list-style-type: none"> <li>• Message sent by thermostat to unit after more than 15 minutes asking for initiating heating or cooling with no response from unit.</li> <li>• Message sent by thermostat to unit after more than 15 minutes asking for termination of heating or cooling with no response from unit.</li> </ul> <p><b>Result</b> A communicating device in the system has been disabled due to a fault/lockout code in the unit's control. Another possible cause is electrical noise interference affecting the communicating system when the compressor contactor coil is energized.</p> <p><b>Corrective Action:</b></p> <ul style="list-style-type: none"> <li>• Communicating system: Wire a transient voltage suppressor in parallel with the compressor contactor coil terminals on the outdoor unit.</li> <li>• Non-communicating outdoor unit: Wire transient voltage suppressor (<a href="#">89W72</a>) in parallel with compressor contactor coil or across the Y1 and C terminals on the indoor control board.</li> </ul> <p><b>NOTE:</b> See service and application note <a href="#">IAQ-10-01</a> for further details.</p> <p>Transient Voltage Suppressor Part information: Made by Little Fuse, part number <a href="#">5KP43CA</a> bidirectional Transorb aka TVS Diode. Please contact your FTC or inside technical support for help in acquiring the transient voltage suppressor if not available in your local electronics store.</p>

**Table 19. Alert Codes and Troubleshooting**

Initial notification of critical alerts will pop-up on the home screen and will be listed under notification menu. Minor and moderate alerts are found only under the notification menu. Moderate alerts are not e-mailed to Homeowners. Dealers will get an email and code can be seen on thermostat under the installer notification section.

**NOTE:** Anytime the word **DEVICE** or **DEVICE2** is used in this table, it will be replaced on all alert code notification screens with the actual offending device name, for example, thermostat, heat pump, etc.).

Alert Code	Inverter Flash Code	Priority Condition	Applicable Component	Actual Displayed Alert Text	Component or System Operational State and Troubleshooting Tip
36		Critical	HD Display (Thermostat)	Heating when Not Requested DEVICE2	<p>The system has been heating for at least 15 minutes without a demand for heating.</p> <ul style="list-style-type: none"> <li>Run the system in diagnostic mode and verify that it matches actual equipment operation. Go to <b>menu &gt; settings &gt; advanced settings &gt; dealer control center &gt; diagnostics</b> and press the <b>start diagnostics</b> button.</li> <li>Check for other alert codes that may be preventing the system from operating as expected.</li> <li>Check all heating equipment to determine cause of heating demand.</li> <li>Recycle power.</li> <li>Automatically clears when the system detects that the issue no longer exists.</li> </ul>
37		Critical	HD Display (Thermostat)	Cooling when not Requested DEVICE2	<p>The system has been cooling for at least 15 minutes, without a demand for cooling.</p> <ul style="list-style-type: none"> <li>Run the system in diagnostic mode and verify that it matches actual equipment operation. Go to <b>menu &gt; settings &gt; advanced settings &gt; dealer control center &gt; diagnostics</b> and press the <b>start diagnostics</b> button.</li> <li>Check for other alert codes that may be preventing the system from operating as expected.</li> <li>Check all cooling equipment to determine cause of cooling demand.</li> <li>Recycle power.</li> <li>Automatically clears when the system detects that the issue no longer exists.</li> </ul>
38		Critical	HD Display (Thermostat)	No Heating when Requested DEVICE2	<p>The system has not been able to turn on the heating for more than 45 minutes.</p> <ul style="list-style-type: none"> <li>The system will go off-line for 60 minutes and will attempt to restart itself.</li> <li>Run the system in diagnostic mode and verify that it matches actual equipment operation. Go to <b>menu &gt; settings &gt; advanced settings &gt; dealer control center &gt; diagnostics</b> and press the <b>start diagnostics</b> button</li> </ul>
39		Critical	HD Display (Thermostat)	No Cooling when Requested DEVICE2	<ul style="list-style-type: none"> <li>Check for other alert codes that may be preventing the system from operating as expected.</li> <li>Check all heating equipment to determine cause.</li> <li>Recycle power.</li> <li>This alert code will automatically clear when the system detects the issue no longer exists.</li> </ul>

**Table 19. Alert Codes and Troubleshooting**

Initial notification of critical alerts will pop-up on the home screen and will be listed under notification menu. Minor and moderate alerts are found only under the notification menu. Moderate alerts are not e-mailed to Homeowners. Dealers will get an email and code can be seen on thermostat under the installer notification section.

**NOTE:** Anytime the word **DEVICE** or **DEVICE2** is used in this table, it will be replaced on all alert code notification screens with the actual offending device name, for example, thermostat, heat pump, etc.).

Alert Code	Inverter Flash Code	Priority Condition	Applicable Component	Actual Displayed Alert Text	Component or System Operational State and Troubleshooting Tip
40		Critical	Heat Pump	HP Heating Lockout.	<p>The heat pump could not increase the room temperature 1/2 degree towards the set point in 30 minutes. To use the gas furnace as a primary heating source (not defrost tempering) when the outdoor temperature is between the high and low balance points, the heat pump:</p> <ul style="list-style-type: none"> <li>• Must be used for a minimum of 30 minutes and the temperature in the zone not increase by more than 1/2 degree.</li> <li>• Has not gone into defrost in the 30 minute period.</li> </ul> <p>The default for HP Heating Lockout Time default is 120 minutes and will lock the heat pump out when the outdoor temperature is above the high balance point. Selectable range is 60 to 240 minutes.</p> <ul style="list-style-type: none"> <li>• Go to <b>menu &gt; settings &gt; advanced settings &gt; dealer control center &gt; equipment &gt; smart hub</b> and located <b>HP Heating Lockout Time</b> to verify the lockout time setting.</li> <li>• Check air flow to the zones or zones.</li> <li>• Check discharge air temperatures.</li> <li>• Check calibration of room thermostat.</li> </ul> <p>(Outdoor unit) When the heat pump could not get a zone thermostat to progress 1/2 degree towards the set point in 30 minutes the system will lock out the heat pump and switch to the secondary heat source. (Electric heat or if in dual fuel applications the furnace will be used and the system put in heat pump heating lockout timer) default is 120 minutes. It will lock the heat pump off and the gas furnace will finish the heating cycle</p> <p>Set the low and high balance points as close together as possible. (This will be a three degree difference – Example: set high balance point at 25°F and low balance point would set at 22°F). Below the low balance point, the furnace will heat the home / between the low and high balance point, the heat pump and furnace will heat the home. I when the outdoor temperature is above the high balance point, the gas furnace is locked out and all the heat is provided by the heat pump.</p>
41		Moderate	All communicating components	Control Board Replaced	<ul style="list-style-type: none"> <li>• This alert code will appear anytime a communicating control [<i>Furnace, air handler, PureAir S, damper control module, air conditioner or heat pump</i>] is replaced in the system.</li> <li>• Must be cleared manually.</li> </ul>

**Table 19. Alert Codes and Troubleshooting**

Initial notification of critical alerts will pop-up on the home screen and will be listed under notification menu. Minor and moderate alerts are found only under the notification menu. Moderate alerts are not e-mailed to Homeowners. Dealers will get an email and code can be seen on thermostat under the installer notification section.

**NOTE:** Anytime the word **DEVICE** or **DEVICE2** is used in this table, it will be replaced on all alert code notification screens with the actual offending device name, for example, thermostat, heat pump, etc.).

Alert Code	Inverter Flash Code	Priority Condition	Applicable Component	Actual Displayed Alert Text	Component or System Operational State and Troubleshooting Tip
105		Critical	All communicating components	Communication Problem	<p>One of the system components has lost communication with the system. The system component (device) is unable to communicate.</p> <ul style="list-style-type: none"> <li>• <b>S30</b> - Access dealer control center, select notifications icon, review alert code details to determine which device or unit has the communication problem. Review both active and cleared alerts.</li> <li>• <b>iHarmony Zoning</b> - Remove wire from smart hub to iHarmony control and just have wiring from furnace.</li> </ul> <p><b>Troubleshooting:</b></p> <ul style="list-style-type: none"> <li>• Check each control for additional codes</li> <li>• In most cases issues are related to electrical noise. Verify that high voltage power is separated from the low voltage communication wires.</li> <li>• Check for proper grounding on line voltage and low voltage wiring, transformer and equipment.</li> <li>• Check for incorrectly wired or loose or spliced connections between system components (devices or units).</li> <li>• Make sure all unused wires are tied together and taken back to the <b>C</b> terminal on the indoor control board as shown in the installation and setup guide.</li> <li>• Make sure that smart hub has proper software version for added accessory. (Example: Pure Air <b>S</b> and/or Apple Home Kit must have software version 3.4 or higher before it will connect to system properly. (If software is not updated in system it will cause system operation issues).</li> <li>• If zoning is installed and is wired directly from smart hub to iHarmony control then disconnect that wiring. Run control wiring from the iHarmony control directly to the indoor unit control. Wiring diagrams are provided in the iHarmony Installation and Setup Guide.</li> <li>• When using a float switch, use isolation relay to break common wire to outdoor unit. For testing purposes, remove float switch from the circuit.</li> <li>• Disconnect all wiring to other system components (except thermostat to indoor unit) and reconnect one device at a time and recommission system each time a device is reconnected until the issue is located. See</li> <li>• Automatically clears when the system detects the issue no longer exists.</li> </ul>
110		Critical	Furnace	Low AC Line Voltage	<p>The component AC line voltage is too low. This alert code may appear during a brownout.</p> <ul style="list-style-type: none"> <li>• It may also occur when line voltage is below its designed operating value.</li> <li>• Check and correct the power line voltage.</li> <li>• Automatically clears when the system detects the issue no longer exists.</li> </ul>
111		Critical	Furnace	Line Polarity Reversed	<p>The unit is reporting that its power and neutral lines are reversed.</p> <ul style="list-style-type: none"> <li>• Turn off the power to the system and correct the line power voltage wiring.</li> <li>• System resumes normal operation five seconds after critical condition is recovered.</li> <li>• Automatically clears when the system detects the issue no longer exists.</li> </ul>
112		Critical	Furnace	No Ground Connection	<p>The reporting component cannot find earth ground. The thermostat will shut down the system.</p> <ul style="list-style-type: none"> <li>• Provide proper earth ground to the equipment.</li> <li>• System resumes normal operation five seconds after critical condition is recovered.</li> <li>• Automatically clears when the system detects the issue no longer exists.</li> </ul>

**Table 19. Alert Codes and Troubleshooting**

Initial notification of critical alerts will pop-up on the home screen and will be listed under notification menu. Minor and moderate alerts are found only under the notification menu. Moderate alerts are not e-mailed to Homeowners. Dealers will get an email and code can be seen on thermostat under the installer notification section.

**NOTE:** Anytime the word **DEVICE** or **DEVICE2** is used in this table, it will be replaced on all alert code notification screens with the actual offending device name, for example, thermostat, heat pump, etc.).

Alert Code	Inverter Flash Code	Priority Condition	Applicable Component	Actual Displayed Alert Text	Component or System Operational State and Troubleshooting Tip
113		Critical	Furnace	High AC Line Voltage	<p>Line voltage high (voltage higher than nameplate rating).</p> <ul style="list-style-type: none"> <li>• Provide power voltage within proper range.</li> <li>• System resumes normal operation five seconds after critical condition is recovered.</li> <li>• Automatically clears when the system detects the issue no longer exists.</li> </ul>
114		Moderate / Critical	All communicating components	AC Line Frequency / Distortion Prob	<p>In most cases the errors will have something to do with the transformer(s) phasing, input power or output loading (amperage load). For the air handler control only, alert code 114 is generated only if the measured line frequency is below 57Hz or above 63Hz and remains out of range for 10 consecutive seconds. We count power line cycles and determine line frequency every 1 second of time based on the processor's quartz crystal oscillator. We have a fair amount of filtering on when we consider a power line cycle to have occurred, so there would have to be really bad distortion for it to count an extra cycle or miss a real cycle. Voltage low enough to miss a cycle would generate an alert code 115. There are lots of events, such as power utility substation switching, that could occasionally make our power line frequency off by one count. These are rare one-time events and I don't know anything other than a generator with bad frequency that could cause problems long enough to cause this alert code. There is a frequency / distortion problem with the power to a specific system component. This alert code may indicate transformer overloading.</p> <ul style="list-style-type: none"> <li>• Check the voltage and line power frequency.</li> <li>• Check the generator operating frequency, if the system is running on back-up power.</li> <li>• Correct voltage and frequency problems.</li> <li>• System will resume normal operation five seconds after fault recovered.</li> <li>• All applicable system component outputs are disabled – moderate condition.</li> <li>• After 10 minutes, the priority condition is escalated – critical condition.</li> <li>• iHarmony control module will operate in central mode only until proper voltage is restored or frequency distortion is resolved – moderate condition.</li> </ul> <p><b>NOTE:</b> The unitary control (outdoor unit control board) whether it is a single, two-stage or multi-stage control is not displaying alert code 114.</p> <ul style="list-style-type: none"> <li>• If connected to iHarmony, set damper control module transformer jumper to system transformer. Check for proper wiring. Replace 40 VA furnace transformer with 70VA transformer. Recommission system.</li> </ul>
115		Critical	All communicating components	Low Secondary (24VAC) Voltage	<p>24VAC power to a system component control is lower than the required range of 18 to 30VAC.</p> <ul style="list-style-type: none"> <li>• Check and correct voltage.</li> <li>• Check for additional power-robbing system components (devices) connected to system.</li> <li>• This alert code may require the installation of an additional or larger VA transformer.</li> <li>• Damper control module will operate in non-zone mode until proper voltage is restored.</li> <li>• Automatically clears when the system detects the issue no longer exists.</li> </ul>

**Table 19. Alert Codes and Troubleshooting**

Initial notification of critical alerts will pop-up on the home screen and will be listed under notification menu. Minor and moderate alerts are found only under the notification menu. Moderate alerts are not e-mailed to Homeowners. Dealers will get an email and code can be seen on thermostat under the installer notification section.

**NOTE:** Anytime the word **DEVICE** or **DEVICE2** is used in this table, it will be replaced on all alert code notification screens with the actual offending device name, for example, thermostat, heat pump, etc.).

Alert Code	Inverter Flash Code	Priority Condition	Applicable Component	Actual Displayed Alert Text	Component or System Operational State and Troubleshooting Tip
116		Critical	Furnace or Air Handler	High Secondary (24VAC) voltage	<ul style="list-style-type: none"> <li>Thermostat will display this code when 24VAC power is high (18 to 30 VAC).</li> <li>Will display Furnace or Air Handler High Secondary (24VAC) voltage.</li> <li>Check and correct voltage. Check for proper line voltage (120V, 240V, etc.) to equipment. Clears when control senses proper voltage.</li> </ul>
120		Moderate	All communicating components	Unresponsive DEVICE2.	<p>There is a delay in the system component responding to the system. Typically this alert code does not cause any operational issues and will clear on its own.</p> <ul style="list-style-type: none"> <li>This alert code is usually caused by a delay in the outdoor unit responding to the thermostat.</li> <li>Check all wiring connections.</li> <li>Automatically clears after an unresponsive system component (device) responds to any inquiry.</li> </ul>
124		Critical	All communicating components	Active Subnet Controller Missing (Active Component Communication Device Missing)	<p>The thermostat has lost communication with a system component for more than three minutes. System component has lost communication with the thermostat.</p> <ul style="list-style-type: none"> <li>Check the wiring connections between components.</li> <li>Ohm wires.</li> <li>Cycle power.</li> <li>Any component that is miss-wired may cause a false component code to be shown on system component.</li> <li>Disconnect all wiring to other system components and check communication one at a time.</li> </ul> <p><b>NOTE:</b> When using a float switch, use isolation relay to break common wire to outdoor unit. For testing purposes, remove float switch from the circuit</p> <p>This alert code stops all associated system operations and waits for a heartbeat message from the system component that is not communicating.</p> <ul style="list-style-type: none"> <li>Automatically clears after communication is re-established with applicable system component (device).</li> </ul>
125		Critical	All communicating components	Control Hardware Problem	<p>There is a hardware problem on a system component control. There is a control hardware problem.</p> <ul style="list-style-type: none"> <li>Replace the control if the problem prevents operation and is persistent.</li> <li>Damper control module will remain in non-zone mode (all dampers open) for five minutes after priority condition no longer exist.</li> <li>Remove jumper if present on indoor unit between <b>R</b> and <b>W2</b> if equipment interface module is in use.</li> <li>On the PureAir S control the jumper selector is missing.</li> <li>Automatically clears five minutes after the issue no longer exists.</li> </ul>

**Table 19. Alert Codes and Troubleshooting**

Initial notification of critical alerts will pop-up on the home screen and will be listed under notification menu. Minor and moderate alerts are found only under the notification menu. Moderate alerts are not e-mailed to Homeowners. Dealers will get an email and code can be seen on thermostat under the installer notification section.

**NOTE:** Anytime the word **DEVICE** or **DEVICE2** is used in this table, it will be replaced on all alert code notification screens with the actual offending device name, for example, thermostat, heat pump, etc.).

Alert Code	Inverter Flash Code	Priority Condition	Applicable Component	Actual Displayed Alert Text	Component or System Operational State and Troubleshooting Tip
126		Critical	Furnace, air handler or outdoor unit	Control Internal Communication Problem	<p>There is an internal hardware problem on the system component control. In addition, if you have zoning the alert code is triggered when your zone temperature is deviating away from set point persistently.</p> <ul style="list-style-type: none"> <li>Typically the system component control will reset itself.</li> <li>Replace the system component (device) control if the problem prevents operation and is persistent.</li> <li>Automatically clears 300 seconds after the issue no longer exists.</li> </ul>
130		Moderate	Equipment interface module	Configuration Jumper Missing	<ul style="list-style-type: none"> <li>Configuration jumper missing on equipment interface module.</li> <li>Install the missing jumper.</li> <li>Set as heat pump, furnace control or air handler control.</li> </ul> <p><b>NOTE:</b> This is applicable in non-communicating applications only).</p> <ul style="list-style-type: none"> <li>Automatically clears after the missing or incorrectly installed jumper is installed or corrected.</li> </ul>
131		Critical	All communicating components	Corrupted Control Parameters	<p>System component control parameters are corrupted.</p> <ul style="list-style-type: none"> <li>Replace the system component control if heating or cooling is not available.</li> <li>Go to <b>menu &gt; settings &gt; advanced settings &gt; view dealer control center &gt; equipment</b> and press <b>reset all equipment</b>. This will allow the system to auto-detect any Lennox communicating components attached.</li> <li>Will automatically clear when system component (device) passes memory self-test or system component control is replaced.</li> </ul>
132		Critical	All communicating components	Failed Flash CRC Check	<p>System component control software is corrupted.</p> <ul style="list-style-type: none"> <li>Recycle power.</li> <li>If failure re-occurs, replace the system component control.</li> <li>Manual system power reset is required to recover from this alert code.</li> </ul>
180		Critical	Outdoor Unit	Outdoor Temperature Sensor Problem	<p>The thermostat has found a problem with the outdoor temperature sensor. In normal operation after system component control recognizes sensors, the alert code will be sent if valid temperature reading is lost.</p> <ul style="list-style-type: none"> <li>Compare outdoor sensor resistance to temperature / resistance charts in unit installation instructions.</li> <li>Replace sensors pack if necessary.</li> <li>At the beginning of (any) configuration, furnace, air-handler control or equipment interface module will detect the presence of the sensor(s).</li> <li>If detected (reading in range), appropriate feature will be set as 'installed' and shown in the 'About' screen.</li> <li>Automatically clears upon configuration, or sensing normal values.</li> </ul>

**Table 19. Alert Codes and Troubleshooting**

Initial notification of critical alerts will pop-up on the home screen and will be listed under notification menu. Minor and moderate alerts are found only under the notification menu. Moderate alerts are not e-mailed to Homeowners. Dealers will get an email and code can be seen on thermostat under the installer notification section.

**NOTE:** Anytime the word **DEVICE** or **DEVICE2** is used in this table, it will be replaced on all alert code notification screens with the actual offending device name, for example, thermostat, heat pump, etc.).

Alert Code	Inverter Flash Code	Priority Condition	Applicable Component	Actual Displayed Alert Text	Component or System Operational State and Troubleshooting Tip
200		Critical	Furnace	Rollout Limit Switch Open	<p>The furnace roll out limit switch is open. Correct the cause of roll out trip.</p> <ul style="list-style-type: none"> <li>• Reset roll out switch.</li> <li>• Test the furnace operation.</li> <li>• Check for blocked or obstructed vent pipe (Intake and/or Exhaust).</li> <li>• Check for flame stability, if flame is unstable, look for cause.</li> <li>• Automatically clears after the furnace roll out switch is closed.</li> </ul>
201		Critical	Furnace or air handler	Indoor Blower Motor Problem	<p>Lost communication with indoor blower motor.</p> <ul style="list-style-type: none"> <li>• Possible causes include power outage, brown-out, motor not powered, loose wiring, condensation on system component control without cover on breaker.</li> <li>• Problem may be on system component control or motor side.</li> <li>• Automatically clears after communication is restored.</li> </ul>
202		Critical	Furnace or air handler	ID Blower Motor & Unit Size Mismatch	<p>The unit size code for the indoor unit and the size of blower motor do not match. Incorrect appliance unit size code selected.</p> <ul style="list-style-type: none"> <li>• Remove the thermostat from the system while applying power and reprogramming.</li> <li>• Check for proper configuring under unit size codes for furnace/air handler in configuration guide or in installation instructions.</li> <li>• Automatically clears after the correct match is detected following a reset.</li> </ul>
203		Critical	Furnace or air handler	Invalid Unit Code	<p>The unit size code for the indoor unit has not been selected or set incorrectly.</p> <ul style="list-style-type: none"> <li>• Verify that the correct unit size code is configured. Unit size codes for furnace and air handler are listed in the system component configuration guide or installation instruction.</li> <li>• Remove the thermostat from the system while applying power and set the unit size code per instructions provided in the indoor unit installation instruction.</li> <li>• Automatically clears after the correct match is detected following a reset.</li> </ul>
204		Critical	Furnace	Gas Valve Problem	<p>There is an issue with the furnace gas valve.</p> <ul style="list-style-type: none"> <li>• Check gas valve operation and wiring.</li> <li>• Check for voltage to the gas valve.</li> <li>• Automatically clears after the issue is corrected.</li> </ul>
205		Critical	Furnace	Gas Valve relay Contact Closed	<ul style="list-style-type: none"> <li>• The furnace gas valve relay contact is closed. Verify wiring on control and gas valve or in good order, not missing or damage..</li> <li>• Automatically clears after the issue is corrected.</li> </ul>
206		Critical	Furnace	Gas Valve 2nd Stage Relay Failure	<p>The furnace gas valve second-stage relay is faulty.</p> <ul style="list-style-type: none"> <li>• Furnace will operate on first-stage for the remainder of the heating demand</li> <li>• If unable to operate second-stage, replace furnace control.</li> <li>• Automatically clears after the issue is corrected.</li> </ul>



**Table 19. Alert Codes and Troubleshooting**

Initial notification of critical alerts will pop-up on the home screen and will be listed under notification menu. Minor and moderate alerts are found only under the notification menu. Moderate alerts are not e-mailed to Homeowners. Dealers will get an email and code can be seen on thermostat under the installer notification section.

**NOTE:** Anytime the word **DEVICE** or **DEVICE2** is used in this table, it will be replaced on all alert code notification screens with the actual offending device name, for example, thermostat, heat pump, etc.).

Alert Code	Inverter Flash Code	Priority Condition	Applicable Component	Actual Displayed Alert Text	Component or System Operational State and Troubleshooting Tip
207		Critical	Furnace	Hot Surface Igniter (HSI) Sensed Open	<p>The furnace hot surface igniter is open.</p> <ul style="list-style-type: none"> <li>• Measure the resistance of hot surface igniter.</li> <li>• Replace the igniter if it is not within the specified range found in furnace installation instruction.</li> <li>• Automatically clears after the issue is corrected.</li> </ul>
223		Critical	Furnace	Low Pressure Switch Open	<p>The furnace low pressure switch is open.</p> <ul style="list-style-type: none"> <li>• Check pressure (inches w.c.) of the low pressure switch closing during a heat call.</li> <li>• Measure operating pressure (inches w.c.).</li> <li>• Inspect vent for blockages and combustion air inducer for correct operation and restriction.</li> <li>• Check for blocked cold end heater box or condensate drain or drain strainers at outlet of cold end heater box.</li> <li>• Check for cracked hoses.</li> <li>• Check levelness of unit.</li> </ul> <p><b>NOTE:</b> Check Service Manual and Service and Application Note <a href="#">H-13-07</a> "Condensing Furnace Pressure Switch Troubleshooting" for additional information.</p> <ul style="list-style-type: none"> <li>• Automatically clears after the issue is corrected.</li> </ul>
224		Critical	Furnace	Low Pressure Switch Stuck Closed	<p>The furnace low pressure switch is stuck closed.</p> <ul style="list-style-type: none"> <li>• Check operation of low pressure switch to see if it is stuck closed for longer than 150 seconds during a heat call.</li> <li>• Measure operating pressure (inches w.c.).</li> <li>• Inspect vent for blockage and combustion air inducer for correct operation and restriction.</li> <li>• Check for moisture in pressure switch.</li> </ul> <p><b>NOTE:</b> Check Service Manual and Service and Application Note <a href="#">H-13-07</a> "Condensing Furnace Pressure Switch Troubleshooting" for additional information.</p> <ul style="list-style-type: none"> <li>• Automatically clears after the issue is corrected.</li> </ul>
225		Moderate	Furnace	High Press. Switch Failed to Close	<p>The furnace high pressure switch will not close.</p> <ul style="list-style-type: none"> <li>• Check pressure (inches w.c.) of high pressure switch closing during a heat call.</li> <li>• Measure operating pressure (inches w.c.).</li> <li>• Inspect vent for blockage and combustion air inducer for correct operation and restriction.</li> <li>• Check for blocked cold end heater box or condensate drain or drain strainers at outlet of the cold end heater box.</li> </ul> <p><b>NOTE:</b> Check Service Manual and Service and Application Note <a href="#">H-13-07</a> "Condensing Furnace Pressure Switch Troubleshooting" for additional information.</p> <ul style="list-style-type: none"> <li>• Automatically clears after the issue is corrected.</li> </ul>

**Table 19. Alert Codes and Troubleshooting**

Initial notification of critical alerts will pop-up on the home screen and will be listed under notification menu. Minor and moderate alerts are found only under the notification menu. Moderate alerts are not e-mailed to Homeowners. Dealers will get an email and code can be seen on thermostat under the installer notification section.

**NOTE:** Anytime the word **DEVICE** or **DEVICE2** is used in this table, it will be replaced on all alert code notification screens with the actual offending device name, for example, thermostat, heat pump, etc.).

Alert Code	Inverter Flash Code	Priority Condition	Applicable Component	Actual Displayed Alert Text	Component or System Operational State and Troubleshooting Tip
226		Critical	Furnace	High Pressure Switch Stuck Closed	<p>The furnace high pressure switch will not open.</p> <ul style="list-style-type: none"> <li>• Check operation of high pressure switch closing during a heat call.</li> <li>• Measure operating pressure (inches w.c.).</li> <li>• Inspect vent for blockage and combustion air inducer for correct operation and restriction.</li> <li>• Check for moisture in pressure switch.</li> </ul> <p><b>NOTE:</b> Check Service Manual and Service and Application Note <a href="#">H-13-07</a> “Condensing Furnace Pressure Switch Troubleshooting” for additional information.</p> <ul style="list-style-type: none"> <li>• Automatically clears after the issue is corrected.</li> </ul>
227		Moderate	Furnace	Low Pressure Switch Open in Run Mode	<p>The furnace low pressure switch is open while in run mode.</p> <ul style="list-style-type: none"> <li>• Check pressure (inches w.c.) of low pressure switch closing during a heat call.</li> <li>• Measure operating pressure (inches w.c.).</li> <li>• Inspect vent for blockage and combustion air inducer for correct operation and restriction.</li> <li>• Check for blocked cold end heater box or condensate drain or drain strainers at outlet of cold end heater box.</li> <li>• Check for cracked hoses.</li> <li>• Check levelness of unit.</li> </ul> <p><b>NOTE:</b> Check Service Manual and Service and Application Note <a href="#">H-13-07</a> “Condensing Furnace Pressure Switch Troubleshooting” for additional information.</p> <ul style="list-style-type: none"> <li>• Automatically clears after the issue is corrected.</li> </ul>
228		Moderate	Furnace	Inducer / Press. Switch Calib. Failure	<p>The furnace control is not able to calibrate the pressure switch. Unable to perform pressure switch calibration.</p> <ul style="list-style-type: none"> <li>• Inspect vent for blockage and combustion air inducer for correct operation and restriction.</li> <li>• Check for blocked cold end heater box or condensate drain or drain strainers at outlet of cold end heater box (CEHB).</li> <li>• Check for cracked hoses.</li> <li>• Check levelness of unit.</li> </ul> <p><b>NOTE:</b> Check Service Manual and Service and Application Note <a href="#">H-13-07</a> “Condensing Furnace Pressure Switch Troubleshooting” for additional information.</p> <ul style="list-style-type: none"> <li>• Automatically clears after the issue is corrected.</li> </ul>

**Table 19. Alert Codes and Troubleshooting**

Initial notification of critical alerts will pop-up on the home screen and will be listed under notification menu. Minor and moderate alerts are found only under the notification menu. Moderate alerts are not e-mailed to Homeowners. Dealers will get an email and code can be seen on thermostat under the installer notification section.

**NOTE:** Anytime the word **DEVICE** or **DEVICE2** is used in this table, it will be replaced on all alert code notification screens with the actual offending device name, for example, thermostat, heat pump, etc.).

Alert Code	Inverter Flash Code	Priority Condition	Applicable Component	Actual Displayed Alert Text	Component or System Operational State and Troubleshooting Tip
240		Moderate	Furnace	Low Flame Current - Run Mode	<p>This could be either low flame current or a loss of flame while in run mode.</p> <ul style="list-style-type: none"> <li>• Check micro-amperes of the flame sensor using thermostat or control board.</li> <li>• Clean or replace the flame sensor.</li> <li>• Measure voltage of neutral to ground to ensure good unit ground.</li> <li>• Clean face of burner assembly.</li> <li>• Confirm that the vent termination is properly installed and not recirculating.</li> <li>• Check for loose a wiring connection at gas valve.</li> </ul> <p><b>NOTE:</b> Refer to Service and Application Note <a href="#">H-14-06</a> “Flame Rectification In All Gas Furnaces” for additional information.</p> <ul style="list-style-type: none"> <li>• Automatically clears after a proper micro-amp reading has been sensed.</li> </ul>
241		Critical	Furnace	Flame Out of Sequence - Still Present	<p>Flame sensed without call for gas heating. Perform the following:</p> <ul style="list-style-type: none"> <li>• Shut off gas.</li> <li>• Check for a gas valve leak.</li> <li>• Check for voltage to gas valve.</li> <li>• Replace the gas valve if needed.</li> <li>• Automatically clears when a heat call ends successfully.</li> </ul>
250		Moderate	Furnace or zoning dampers	Primary Limit Switch Open	<p>The furnace primary limit switch is open. If limit switch is not closed within three minutes, the unit will go into a 60 minute soft lockout (Watchguard mode). Perform the following:</p> <ul style="list-style-type: none"> <li>• Check for high gas pressure.</li> <li>• Check for low supply air. Low supply air due to being plugged or restriction in system (example: dirty air filter or blockage in duct work).</li> <li>• Check for proper firing rate on furnace.</li> <li>• Check for non-functioning zone dampers.</li> </ul> <p><b>NOTE:</b> Limit trips will place the iHarmony zoning system into non-zone mode.</p> <p><b>NOTE:</b> See <a href="#">ACC-14-01</a> for further details.</p> <p><b>NOTE:</b> If this issue occurred on an iHarmony zoning system, the field will need to manually activate the zoning.</p> <p>Automatically clears when a heat call ends successfully.</p>
252		Moderate	Indoor unit or iHarmony	Discharge Air Temperature High	<p>A discharge air-temperature is high. Perform the following:</p> <ul style="list-style-type: none"> <li>• Check temperature rise, air flow and input rate.</li> <li>• Check for dirty air filter(s).</li> </ul> <p><b>NOTE:</b> See Service and Application Note <a href="#">ACC-14-01</a> for further details.</p> <p>Automatically clears when a heat call ends successfully.</p>

**Table 19. Alert Codes and Troubleshooting**

Initial notification of critical alerts will pop-up on the home screen and will be listed under notification menu. Minor and moderate alerts are found only under the notification menu. Moderate alerts are not e-mailed to Homeowners. Dealers will get an email and code can be seen on thermostat under the installer notification section.

**NOTE:** Anytime the word **DEVICE** or **DEVICE2** is used in this table, it will be replaced on all alert code notification screens with the actual offending device name, for example, thermostat, heat pump, etc.).

Alert Code	Inverter Flash Code	Priority Condition	Applicable Component	Actual Displayed Alert Text	Component or System Operational State and Troubleshooting Tip
270		Critical	Furnace	WatchGuard - Flame Failure on Ignite	<p>The furnace is in Watchguard mode. The furnace igniter cannot turn on the flame. This is a five strike condition during a single demand.</p> <ul style="list-style-type: none"> <li>• Check for proper gas flow.</li> <li>• Ensure that igniter is lighting burner.</li> <li>• Check flame sensor current.</li> <li>• Check for dirty filters.</li> <li>• Check for blocked cold end heater box or condensate drain and cracked hoses.</li> </ul> <p>Automatically clears on successful ignition.</p>
271		Critical	Furnace	WatchGuard - Low Press Switch Open	<p>The furnace is in watchguard mode. The furnace low pressure switch is open. This is a five strike condition during a single demand.</p> <ul style="list-style-type: none"> <li>• Check pressure (inches w.c.) of low pressure switch closing during a heat call.</li> <li>• Measure operating pressure (inches w.c.).</li> <li>• Check for blocked cold end heater box (CEHB), or condensate drain or drain strainers at outlet of CEHB and cracked hoses.</li> <li>• Check for cracked hoses.</li> <li>• Check levelness of unit.</li> </ul> <p><b>NOTE:</b> Check Service Manual and Service and Application Note <a href="#">H-13-07</a> "Condensing Furnace Pressure Switch Troubleshooting" for additional information.</p> <p>Automatically clears on successful ignition.</p>
272		Critical	Furnace	WatchGuard - Lo Press Switch Open Run Mode	<p>The furnace low pressure switch is open during run mode. The system will go into Watchguard mode.</p> <ul style="list-style-type: none"> <li>• Check operation of low pressure switch to see if it is stuck open during a heat call.</li> <li>• Measure operating pressure (inches w.c.).</li> <li>• Inspect vent for blockages, and combustion air inducer for correct operation and restriction.</li> <li>• Check for blocked cold end heater box (CEHB), or condensate drain or drain strainers at outlet of CEHB and cracked hoses.</li> <li>• Check for cracked hoses.</li> <li>• Check levelness of unit.</li> </ul> <p><b>NOTE:</b> Check Service Manual and Service and Application Note <a href="#">H-13-07</a> "Condensing Furnace Pressure Switch Troubleshooting" for additional information.</p> <p>Automatically clears on successful ignition.</p>

**Table 19. Alert Codes and Troubleshooting**

Initial notification of critical alerts will pop-up on the home screen and will be listed under notification menu. Minor and moderate alerts are found only under the notification menu. Moderate alerts are not e-mailed to Homeowners. Dealers will get an email and code can be seen on thermostat under the installer notification section.

**NOTE:** Anytime the word **DEVICE** or **DEVICE2** is used in this table, it will be replaced on all alert code notification screens with the actual offending device name, for example, thermostat, heat pump, etc.).

Alert Code	Inverter Flash Code	Priority Condition	Applicable Component	Actual Displayed Alert Text	Component or System Operational State and Troubleshooting Tip
273		Critical	Furnace	WatchGuard - Flame fail in Run Mode	<p>The furnace flame is going off during a heating cycle. The system will go into Watchguard mode.</p> <ul style="list-style-type: none"> <li>• Check micro-amperes of flame sensor using thermostat diagnostics.</li> <li>• Clean or replace sensor.</li> <li>• Measure voltage of neutral to ground to ensure good unit ground.</li> <li>• Clean face of burner assembly.</li> </ul> <p>Automatically clears when a heat call ends successfully.</p>
274		Critical	Furnace	WatchGuard - Primary Limit Switch Open	<p>The furnace limit switch has been open for more than three minutes. The system will go into Watchguard mode.</p> <ul style="list-style-type: none"> <li>• Check firing rate and air flow.</li> <li>• Check for air blockage.</li> </ul> <p>Automatically clears when a heat call ends successfully.</p>
275		Critical	Furnace	WatchGuard - Flame Out of Seq. No Flame	<p>The furnace flame is out of sequence. The system will go into Watchguard mode.</p> <ul style="list-style-type: none"> <li>• Shut off gas.</li> <li>• Check for gas valve leak.</li> <li>• Check for high gas pressure.</li> <li>• Low supply air due to being plugged or restriction in system (example: dirty air filter or blockage in duct work).</li> <li>• Limit trips will place the iHarmony® zoning system into non-zone mode.</li> <li>• Check for proper firing rate on furnace.</li> <li>• Check for non-functioning zone dampers.</li> </ul> <p><b>NOTE:</b> Refer to Service and Application Note <a href="#">ACC-14-01</a> - iHarmony® and SLP98 - Insufficient Zone Heating and Alert Code 250 Issues for corrective actions.</p> <p>Automatically clears on successful ignition.</p>
276		Critical	Furnace	WatchGuard - Calibration Failure	<p>The furnace is not able to calibrate or the high pressure switch opened or failed to close in run mode. The system will go into Watchguard mode (furnace will lock out for one hour and then try again).</p> <ul style="list-style-type: none"> <li>• Measure operating pressure (inches w.c.).</li> <li>• Inspect vent for blockages, and combustion air inducer for correct operation and restriction.</li> <li>• Check for blocked cold end heater box (CEHB), or condensate drain or drain strainers at outlet of CEHB and cracked hoses.</li> <li>• Check for cracked hoses.</li> <li>• Check levelness of unit.</li> </ul> <p><b>NOTE:</b> Check Service Manual and Service and Application Note <a href="#">H-13-07</a> "Condensing Furnace Pressure Switch Troubleshooting" for additional information.</p> <p>Automatically clears when the furnace calibrates itself successfully.</p>

**Table 19. Alert Codes and Troubleshooting**

Initial notification of critical alerts will pop-up on the home screen and will be listed under notification menu. Minor and moderate alerts are found only under the notification menu. Moderate alerts are not e-mailed to Homeowners. Dealers will get an email and code can be seen on thermostat under the installer notification section.

**NOTE:** Anytime the word **DEVICE** or **DEVICE2** is used in this table, it will be replaced on all alert code notification screens with the actual offending device name, for example, thermostat, heat pump, etc.).

Alert Code	Inverter Flash Code	Priority Condition	Applicable Component	Actual Displayed Alert Text	Component or System Operational State and Troubleshooting Tip
290		Critical	Furnace	Ignition Circuit Problem	<p>There is a problem with the furnace ignition circuit. The system will go into Watchguard mode.</p> <ul style="list-style-type: none"> <li>• Measure resistance of hot surface igniter.</li> <li>• Replace the hot surface igniter; it is not within specifications.</li> <li>• Measure voltage to igniter.</li> </ul> <p>Automatically clears on successful ignition</p>
291		Critical	Furnace	Heat Airflow Restricted Below Min	<p>The heating airflow is below the minimum required level. The system will go into Watchguard mode.</p> <ul style="list-style-type: none"> <li>• Check for dirty air filter(s) and other air flow restrictions.</li> <li>• Check blower performance.</li> </ul> <p>Automatically clears when a heat call ends successfully.</p>
292		Critical	Furnace or zoning dampers (if applicable)	Indoor Blower Motor Start Problem	<p>The indoor unit blower motor will not start. The system will go into Watchguard mode.</p> <ul style="list-style-type: none"> <li>• Indoor blower motor unable to start.</li> <li>• This could be due to seized bearing, stuck wheel, and obstructions.</li> <li>• Replace motor, motor module or wheel if assembly does not operate or meet performance standards.</li> </ul> <p>Automatically clears after the indoor blower motor starts successfully.</p>
294		Critical	Furnace	Inducer Motor Overcurrent	<p>There is over current in the furnace inducer motor. The system will go into Watchguard mode.</p> <ul style="list-style-type: none"> <li>• Check combustion blower bearings, wiring and amps.</li> <li>• Replace furnace inducer motor if it does not operate or does not meet performance standards.</li> </ul> <p><b>NOTE:</b> Refer to Service and Application Note <a href="#">H-17-02</a> "All Communicating Variable Speed Motors".</p> <p>Automatically clears after inducer motor current is sensed to be in-range after the ignition following either Watchguard mode or unit reset.</p>
310		Moderate	Indoor unit or iHarmony control module	Discharge Air Temp Sensor Problem	<p>There is a discharge air temperature sensor issue.</p> <ul style="list-style-type: none"> <li>• Compare discharge temperature sensor (DATS) resistance to temperature / resistance charts in system component installation instruction.</li> <li>• Replace discharge air sensor if necessary.</li> </ul> <p><b>NOTE:</b> Confirm there is no short or open circuits in the Lennox communicating thermostat connections to any of the other components in the communication system.</p> <p><b>NOTE:</b> Issues with a discharge air temperature sensor (DATS) connected to a iHarmony control module or equipment interface model will not generate an alert code.</p> <p>Automatically clears 30 seconds after condition is detected as recovered or after system restart.</p>

**Table 19. Alert Codes and Troubleshooting**

Initial notification of critical alerts will pop-up on the home screen and will be listed under notification menu. Minor and moderate alerts are found only under the notification menu. Moderate alerts are not e-mailed to Homeowners. Dealers will get an email and code can be seen on thermostat under the installer notification section.

**NOTE:** Anytime the word **DEVICE** or **DEVICE2** is used in this table, it will be replaced on all alert code notification screens with the actual offending device name, for example, thermostat, heat pump, etc.).

Alert Code	Inverter Flash Code	Priority Condition	Applicable Component	Actual Displayed Alert Text	Component or System Operational State and Troubleshooting Tip
312		Minor	Furnace or air handler	Reduced/Airflow-Indoor Blower Cutback	<p>The indoor blower cannot provide the requested CFM due to excessive static pressure. This is a warning only alert code.</p> <ul style="list-style-type: none"> <li>• Static pressure has exceeded the capability of the blower motor.</li> <li>•</li> <li>• Possible restricted airflow - Indoor blower is running at a reduced CFM (Cutback Mode).</li> <li>• The variable speed motor has pre-set speed and torque limiters to protect the motor from damage caused by operating outside of design parameters (0 to 0.8" e.g. total external static pressure).</li> <li>• Check air filter and duct system.</li> <li>• To clear, replace air filter if needed or repair or add additional ducting.</li> </ul> <p><b>NOTE:</b> Blower motor cutbacks will not show alarm code. Duct static pressure reading must be taken.</p> <ul style="list-style-type: none"> <li>• Automatically clears when a heating call finishes successfully.</li> </ul>
313		Minor	Furnace, air handler and outdoor unit	Indoor/Outdoor Unit Capacity Mismatch	<p>The indoor and outdoor unit capacities do not match. This is a warning only alert code.</p> <ul style="list-style-type: none"> <li>• Check for proper system component configuring in installation instructions.</li> <li>• The system will operate, but might not meet efficiency and capacity parameters.</li> </ul> <p>Automatically clears when a heating call finishes successfully.</p>
344		Critical	Furnace	Relay Y1 Stuck	<p>Link Relay Problem. Relay <b>Y1</b> Failure which will result in the all system operations stopping.</p> <p><b>NOTE:</b> Relay is located on the IFC (Integrated Furnace Control). If issue continues replace IFC.</p> <p>Automatically clears five minutes after <b>Y1</b> input sensed OFF.</p>
345		Critical	Air handler, equipment interface module or heat pump	Relay O Failure	<p>The <b>O</b> relay on the system component has failed. Either the pilot relay contacts did not close or the relay coil did not energize.</p> <ul style="list-style-type: none"> <li>• Possible <b>O</b> relay / stage 1 failure.</li> <li>• Pilot relay contacts did not close or the relay coil did not energize.</li> <li>• Replace system component (device) control.</li> <li>• If error is applicable to the any Lennox variable capacity outdoor unit, the outdoor control will need to be replaced.</li> </ul> <p>Automatically clears after the fault recovered following reset.</p>
346		Critical	Air handler	HP Jumper Not Removed	<p>The heat pump configuration link is not cut on the air handler control.</p> <ul style="list-style-type: none"> <li>• Configuration link not cut on air handler control.</li> <li>• Cut <b>O</b> to <b>R</b>.</li> </ul> <p><b>NOTE:</b> This is only applicable with non-communicating heat pump with communicating indoor unit.</p> <p>Automatically clears when the system detects that the issue no longer exists.</p>

**Table 19. Alert Codes and Troubleshooting**

Initial notification of critical alerts will pop-up on the home screen and will be listed under notification menu. Minor and moderate alerts are found only under the notification menu. Moderate alerts are not e-mailed to Homeowners. Dealers will get an email and code can be seen on thermostat under the installer notification section.

**NOTE:** Anytime the word **DEVICE** or **DEVICE2** is used in this table, it will be replaced on all alert code notification screens with the actual offending device name, for example, thermostat, heat pump, etc.).

Alert Code	Inverter Flash Code	Priority Condition	Applicable Component	Actual Displayed Alert Text	Component or System Operational State and Troubleshooting Tip
347		Critical	Indoor unit or equipment interface module	Relay Y1 Failure	<p><b>Sequence of Operation:</b> Communicating room thermostat send a <b>Y1</b> or <b>Y2</b> cooling or heat pump demand to the indoor control asking it to send a <b>Y1</b> or <b>Y2</b> output to the outdoor unit, right? The indoor control then looks to see if it sees 24 volts between the <b>Y1</b> and common or <b>Y2</b> and common on its terminals. If it does not see 24 volts, it sets the code 347.</p> <p>The <b>Y1</b> relay on the applicable system component has failed. Either the pilot relay contacts did not close or the relay coil did not energize.</p> <ul style="list-style-type: none"> <li>• System operation will stop.</li> <li>• Possible <b>Y1</b> relay / stage 1 failure.</li> <li>• Pilot relay contacts did not close or the relay coil did not energize;</li> </ul> <p><b>NOTE:</b> There is no input back to the applicable system component control.</p> <p>Automatically clears after reset and <b>Y1</b> input sensed.</p>
348		Critical	Indoor unit	Relay Y2 Failure	<p><b>Sequence of Operation:</b> Communicating room thermostat send a <b>Y1</b> or <b>Y2</b> cooling or heat pump demand to the indoor control asking it to send a <b>Y1</b> or <b>Y2</b> output to the outdoor unit, right? The indoor control then looks to see if it sees 24 volts between the <b>Y1</b> and common or <b>Y2</b> and common on its terminals. If it does not see 24 volts, it sets the Alert Code 348.</p> <p>The <b>Y2</b> relay on the applicable system component has failed. Either the pilot relay contacts did not close or the relay coil did not energize.</p> <ul style="list-style-type: none"> <li>• Possible <b>Y2</b> relay / stage 2 failure.</li> <li>• Furnace pilot relay contacts did not close or the relay coil did not energize</li> <li>• No input back to furnace or air handler control.</li> </ul> <p>Automatically clears when the system detects that the issue no longer exists.</p>
349		Critical	Furnace	IFC Error Check Jumper O to R	<p>The <b>O</b> to <b>R</b> link on the furnace needs to be restored.</p> <ul style="list-style-type: none"> <li>• Configuration link <b>R</b> to <b>O</b> needs to be restored.</li> <li>• Repair cut link by hard-wiring the <b>R</b> to <b>O</b> terminals on the terminal strip.</li> <li>• Only applicable in non-communicating mode.</li> <li>• Possible cause brown out. Might result in low voltage to which would generate alert code.</li> </ul> <p>Automatically clears when the system detects that the issue no longer exists.</p>
350		Critical	Air handler	Electric Heat Not Configured	<p>The air handler's electric heat is not configured or incorrectly configured.</p> <ul style="list-style-type: none"> <li>• Heat call with no configured or incorrectly configured electric heat.</li> <li>• Check for proper configuring under Configuring Electric Heat Stages in the air handler installation instructions.</li> </ul> <p><b>NOTE:</b> smart hub <b>MUST</b> be removed from the system before configuring electric heat.</p> <p>Automatically clears after electrical heat detection is successful.</p>



**Table 19. Alert Codes and Troubleshooting**

Initial notification of critical alerts will pop-up on the home screen and will be listed under notification menu. Minor and moderate alerts are found only under the notification menu. Moderate alerts are not e-mailed to Homeowners. Dealers will get an email and code can be seen on thermostat under the installer notification section.

**NOTE:** Anytime the word **DEVICE** or **DEVICE2** is used in this table, it will be replaced on all alert code notification screens with the actual offending device name, for example, thermostat, heat pump, etc.).

Alert Code	Inverter Flash Code	Priority Condition	Applicable Component	Actual Displayed Alert Text	Component or System Operational State and Troubleshooting Tip
351		Critical	Air handler	Electric Heat Stage 1 Problem	<p>There is an issue with the air handler's 1st, 2nd, 3rd, 4th or 5th (which is applicable) stage electric heat.</p> <ul style="list-style-type: none"> <li>• Either the pilot relay contacts did not close or the relay coil in the electric heat section did not energize.</li> <li>• Possible heat section / stage 1 failure.</li> </ul> <p><b>NOTE:</b> Air handler will operate on heat pump first stage for the remainder of the heat call.</p> <p>Automatically clears after fault recovered.</p>
352				Electric Heat Stage 2 Problem	
353				Electric Heat Stage 3 Problem	
354				Electric Heat Stage 4 Problem	
355				Electric Heat Stage 5 Problem	
357				Sequencer Stuck Closed	
358		Critical	Air handler	Control Error Check Jumper O to R	Jumper <b>O</b> to <b>R</b> has not been removed. Remove jumper.

**Table 19. Alert Codes and Troubleshooting**

Initial notification of critical alerts will pop-up on the home screen and will be listed under notification menu. Minor and moderate alerts are found only under the notification menu. Moderate alerts are not e-mailed to Homeowners. Dealers will get an email and code can be seen on thermostat under the installer notification section.

**NOTE:** Anytime the word **DEVICE** or **DEVICE2** is used in this table, it will be replaced on all alert code notification screens with the actual offending device name, for example, thermostat, heat pump, etc.).

Alert Code	Inverter Flash Code	Priority Condition	Applicable Component	Actual Displayed Alert Text	Component or System Operational State and Troubleshooting Tip
370		Critical	Furnace	Interlock Switch Open (Float Switch)	<p><b>Communicating Mode:</b></p> <p>In communicating mode, the DS-R terminal can be used with the SLP99V, EL296 and the SL280 furnaces will be used to monitor a field-installed interlock switch such as a float switch. When operating in this capacity, the DS jumper will be monitored as follows:</p> <p><b>NOTE:</b> The on-board jumper <b>DS-R (W914)</b> will be cut.</p> <ul style="list-style-type: none"> <li>When no alert codes are present there will be 24VAC present at this terminal.</li> <li>When controls see the loss of 24VAC for two minutes it will send an alert code 370 and disable all service bits.</li> <li>If currently running a demand, de-energize all outputs (including the blower).</li> <li>The alert code will clear when 24VAC is continuously sensed on <b>DS</b> terminal for a minimum of 10 seconds and the respective alert code clearing message will be sent and service bits restored.</li> <li>In case of an existing interlock switch alert code, upon power reset, an alert code message shall be sent if voltage is not sensed on the <b>DS</b> terminal. An alert code clearing message will be sent if 24VAC is sensed on <b>DS</b> terminal for the minimum of 10 seconds.</li> <li>The monitoring of <b>DS</b> terminal will apply to both variable speed and constant torque controls.</li> </ul> <p><b>Non-Communicating Mode:</b></p> <p>The furnace control has not received 24VAC power for two minutes or more on the DS terminal</p> <ul style="list-style-type: none"> <li>The system will not operate.</li> <li>Dealer has cut the <b>W914</b> jumper (Dehum, Harmony III) on the Lennox furnace control.</li> <li>The thermostat monitors the <b>DS</b> terminal in the furnace for power and if the link has been cut then power will be lost to <b>DS</b>.</li> <li>If DS to R terminal is accidentally cut you must reconnect a jumper from the DS to R on the terminals strip.</li> </ul> <p>This alert code will clear when 24VAC is continuously sensed on <b>DS</b> terminal for a minimum of 10 seconds or on a power reset.</p>
371		Moderate / Critical	Air handler	Float Switch Sensed Open	<p>After being active for 10 minutes (600 seconds) the priority condition will change to Critical. Automatically clears after fault recovered.</p>
380		Moderate / Critical	Equipment interface module	Interlock Relay Failure	<p>Interlock relay failure (furnace or air handler modes only).</p> <ul style="list-style-type: none"> <li>Interlock relay is energized, but input is not sensed after three seconds.</li> <li>There will be no heating or cooling due to this alert code – moderate condition.</li> <li>De-energize interlock relay and energize after five minutes if demand is still present – critical condition.</li> </ul> <p>Automatically clears after fault recovered.</p>
381		Moderate / Critical	Equipment interface module	Interlock Relay Stuck	<p>Interlock relay stuck (furnace or air handler modes only).</p> <ul style="list-style-type: none"> <li>Interlock relay continuously sensed (with relay off).</li> <li>There is no heating and cooling operation – moderation condition.</li> <li>After 10 minutes if event still exist it will be escalated to priority condition critical.</li> </ul> <p>Automatically clears 30 seconds after fault clears.</p>

**Table 19. Alert Codes and Troubleshooting**

Initial notification of critical alerts will pop-up on the home screen and will be listed under notification menu. Minor and moderate alerts are found only under the notification menu. Moderate alerts are not e-mailed to Homeowners. Dealers will get an email and code can be seen on thermostat under the installer notification section.

**NOTE:** Anytime the word **DEVICE** or **DEVICE2** is used in this table, it will be replaced on all alert code notification screens with the actual offending device name, for example, thermostat, heat pump, etc.).

Alert Code	Inverter Flash Code	Priority Condition	Applicable Component	Actual Displayed Alert Text	Component or System Operational State and Troubleshooting Tip
382		Moderate	Equipment interface module	Relay W1 Failure	Relay <b>W1</b> failure (furnace or air handler modes only). <b>W1</b> relay is energized but input is not sensed after three seconds. Automatically clears when W1 relay input is sensed.
400		Critical	Outdoor unit	Compressor Internal Overload Tripped	The compressor internal overload has tripped. <ul style="list-style-type: none"> <li>Thermostat demand <b>Y1</b> is present; however compressor is not running.</li> <li>Check power to unit.</li> <li>This alert code is automatically cleared after current is sensed in both RUN and START sensors for at least two seconds or after service is removed, or after power reset.</li> </ul>
401		Moderate	Outdoor unit	Compressor Long Run Cycle	Either the compressor ran for more than 18 hours continuously while attempting to cool the home during a single demand or the system refrigerant pressure is low. <ul style="list-style-type: none"> <li>Alert code will not lockout system.</li> <li>If the two-stage outdoor unit has an outdoor control with flashing LED lights then the unit will run in low speed;</li> <li>An outdoor control with a seven-segment display, the outdoor control will display alert code 401, but continue to run in high speed.</li> <li>If the outdoor unit is a heat pump, and the outdoor temperature is less than 65°F, alert code 401 is ignored.</li> <li>Also monitors low pressure switch trips.</li> </ul> Automatically clears after 30 consecutive normal run cycles or power reset.
402		Critical	Outdoor unit	Outdoor Unit System Pressure Trip	<ul style="list-style-type: none"> <li>Either the discharge or suction pressure level is out-of-limits, or the compressor has overloaded.</li> <li>Check discharge or suction pressure.</li> </ul> Automatically clears after four consecutive normal compressor run cycles.
403		Moderate	Outdoor unit	Compressor Short-Cycling	The compressor ran for less than three minutes to satisfy a thermostat demand. Automatically clears after four consecutive normal compressor run cycles.
404		Critical	Outdoor unit	Compressor Rotor Locked	The compressor rotor is locked up due to either: <ul style="list-style-type: none"> <li>Run capacitor short.</li> <li>Bearings are seized.</li> <li>Excessive liquid refrigerant.</li> </ul> <b>NOTE:</b> May need to install hard start kit. Automatically clears after four consecutive normal run cycles or after power reset.
405		Critical	Outdoor Unit	Compressor Open Circuit	The compressor circuit is open due to: <ul style="list-style-type: none"> <li>Power disconnection -</li> <li>Open fuse</li> </ul> Automatically clears after one normal compressor run cycle.

**Table 19. Alert Codes and Troubleshooting**

Initial notification of critical alerts will pop-up on the home screen and will be listed under notification menu. Minor and moderate alerts are found only under the notification menu. Moderate alerts are not e-mailed to Homeowners. Dealers will get an email and code can be seen on thermostat under the installer notification section.

**NOTE:** Anytime the word **DEVICE** or **DEVICE2** is used in this table, it will be replaced on all alert code notification screens with the actual offending device name, for example, thermostat, heat pump, etc.).

Alert Code	Inverter Flash Code	Priority Condition	Applicable Component	Actual Displayed Alert Text	Component or System Operational State and Troubleshooting Tip
406		Critical	Outdoor unit	Compressor Open Start Circuit	The required amount of current is not passing through the START current transformer. Automatically clears after current is sensed in START sensor, or after power reset.
407		Critical	Outdoor unit	Compressor Open Run Circuit	The required amount of current is not passing through RUN current transformer. Automatically clears after current is sensed in RUN sensor, one normal compressor run cycle, or after power reset.
408		Critical	Outdoor unit	Compressor Contactor Welded	The compressor is running continuously. Automatically clears one normal compressor run cycle or after power reset.
409		Moderate	Any system component	Compressor Voltage Low	The secondary voltage for the applicable system component has fallen below 18VAC. This may be due to: <ul style="list-style-type: none"> <li>• Secondary voltage is below 18VAC.</li> <li>• If this continues for 10 minutes, the thermostat will turn off the applicable system component.</li> </ul> Automatically clears after voltage is detected as higher than 20VAC for two seconds or after power reset.
410		Moderate	Outdoor unit	Open Low Pressure Switch	Unit low pressure is below the required limit. <ul style="list-style-type: none"> <li>• Check operating pressures.</li> <li>• Low pressure switch opens at a specific pressure (system shuts down) and closes at a specific pressure (system restarts).</li> </ul> Automatically clears when the system detects that the issue no longer exists.
411		Critical	Outdoor unit	Low Pressure Switch Strikes Lockout	The low pressure switch has opened five times during one cooling or heating demand. <ul style="list-style-type: none"> <li>• Thermostat will shut down the outdoor unit.</li> <li>• Open low pressure switch error count reached five strikes.</li> <li>• Check system charge using both approach and sub-cooling methods.</li> <li>• Reset by putting outdoor unit control in test mode or resetting low voltage power.</li> </ul> Automatically clears when the system detects that the issue no longer exists.
412		Moderate	Outdoor unit	Open High Pressure Switch	The unit high pressure is above the upper limit. <ul style="list-style-type: none"> <li>• System will shut down.</li> <li>• Confirm that the system is properly charged with refrigerant.</li> <li>• Check condenser fan motor, expansion valve (if installed), indoor unit blower motor, stuck reversing valve or clogged refrigerant filter.</li> <li>• Confirm that the outdoor unit is clean.</li> </ul> Automatically clears after the high pressure switch closes or a power reset

**Table 19. Alert Codes and Troubleshooting**

Initial notification of critical alerts will pop-up on the home screen and will be listed under notification menu. Minor and moderate alerts are found only under the notification menu. Moderate alerts are not e-mailed to Homeowners. Dealers will get an email and code can be seen on thermostat under the installer notification section.

**NOTE:** Anytime the word **DEVICE** or **DEVICE2** is used in this table, it will be replaced on all alert code notification screens with the actual offending device name, for example, thermostat, heat pump, etc.).

Alert Code	Inverter Flash Code	Priority Condition	Applicable Component	Actual Displayed Alert Text	Component or System Operational State and Troubleshooting Tip
413		Critical	Outdoor unit	Hi Pressure Switch Strikes Lockout	<p>The high pressure switch has opened five times during one cooling demand.</p> <ul style="list-style-type: none"> <li>• Thermostat will shut down the outdoor unit.</li> <li>• Open high pressure switch error count reached five strikes.</li> <li>• Check system charge using superheat and sub-cooling temperatures.</li> <li>• Check outdoor fan operation.</li> <li>• Check for dirt or debris blocking air flow to outdoor unit.</li> <li>• Reset by putting outdoor unit control in test mode or resetting low voltage power.</li> </ul> <p>Automatically clears when the system detects that the issue no longer exists.</p>
414		Moderate	Outdoor unit	High Discharge Line Temperature	<p>The discharge line temperature is higher than the recommended upper limit of 279°F.</p> <ul style="list-style-type: none"> <li>• Discharge line temperature is greater than 279°F.</li> <li>• Make sure coil is clean and airflow unobstructed in and out of condenser.</li> <li>• Check system operating pressures and compare to unit charging charts in installation manual.</li> </ul> <p>Automatically clears after discharge temperature is less than 225°F.</p>
415		Critical	Outdoor unit	Hi Discharge Line Temp Strikes Lockout	<p>The discharge line temperature has been consistently higher than the recommended upper limit of 279°F.</p> <ul style="list-style-type: none"> <li>• Discharge line high temperature error count reached five strikes during a single demand.</li> <li>• Make sure coil is clean and airflow unobstructed in and out of condenser.</li> <li>• Check system charge using superheat and sub cooling temperatures.</li> <li>• Reset by putting outdoor control in test mode or resetting low voltage power.</li> </ul> <p>Correct issue and cycle power to the system.</p>
416		Moderate / Critical	Outdoor unit	Outdoor Coil Sensor Faulty	<p>The outdoor coil sensor is either open, short-circuited or the temperature is out of sensor range.</p> <ul style="list-style-type: none"> <li>• Outdoor unit control will not perform demand or time / temperature defrost operation. (System will still heat or cool.)</li> <li>• This fault is detected by allowing the unit to run for 90 seconds before checking sensor resistance. If the sensor resistance is not within range after 90 seconds, the control will display a moderate code.</li> <li>• Advances from moderate to critical after ten (10) minutes.</li> <li>• Plug-in sensor harness correctly.</li> <li>• Check resistance of sensor to determine if it is open, shorted, out of temperature calibration or out of ambient temperature range. Replace if out-of-specifications.</li> <li>• Automatically clears when outdoor unit control detects proper sensor readings.</li> </ul> <p>If sensor is faulty and the system is reporting the condition as critical, replaced sensor. Reset power to clear alert code.</p>

**Table 19. Alert Codes and Troubleshooting**

Initial notification of critical alerts will pop-up on the home screen and will be listed under notification menu. Minor and moderate alerts are found only under the notification menu. Moderate alerts are not e-mailed to Homeowners. Dealers will get an email and code can be seen on thermostat under the installer notification section.

**NOTE:** Anytime the word **DEVICE** or **DEVICE2** is used in this table, it will be replaced on all alert code notification screens with the actual offending device name, for example, thermostat, heat pump, etc.).

Alert Code	Inverter Flash Code	Priority Condition	Applicable Component	Actual Displayed Alert Text	Component or System Operational State and Troubleshooting Tip
417		Moderate / Critical	Outdoor unit	Discharge Sensor Faulty	<p><b>System Detection and Operation:</b></p> <p>The outdoor unit <b>discharge line</b> temperature sensor is either open, short-circuited or the temperature is out of sensor range.</p> <ul style="list-style-type: none"> <li>This fault is detected by allowing the unit to run for 90 seconds before checking discharge line sensor resistance.</li> <li>If the discharge sensor resistance is not within range after 90 second period, the control will display the priority condition as <b>moderate</b>.</li> <li>If the moderate condition continues for 10 minutes, the system changes the priority condition to <b>critical</b>.</li> </ul> <p><b>Possible Causes:</b></p> <ul style="list-style-type: none"> <li>The applicable system component detects either an open, shorted or temperature out of range condition.</li> <li>Discharge sensor leads located in wrong pin positions in harness plug-in connector. Refer to the applicable unit installation and service procedure and locate the terminal descriptions table to verify cable harness assembly wiring pin positions are correct.</li> </ul> <p><b>Possible Solutions:</b></p> <ul style="list-style-type: none"> <li>Check the resistance of the discharge sensor and compare to temperature resistance chart located in the applicable unit installation and service procedure. If sensor resistance is out of range then replace the discharge line temperature sensor.</li> <li>If discharge sensor wiring leads are located in the wrong connector pin-out then order a replacement cable assembly.</li> <li><b>Moderate</b> - Automatically clears after fault signal condition is no longer present.</li> <li><b>Critical</b> - Power down the system component and either replace faulty sensor or cable assembly (whichever is applicable). Power up system component after replacing the applicable part which will clear the alert code / priority condition.</li> </ul>
418		Moderate	Equipment interface module and outdoor unit	W Output Hardware Fault	<p>There is a faulty <b>W</b> output circuit.</p> <ul style="list-style-type: none"> <li><b>W</b> terminal is energized while in cooling mode.</li> <li>Possible cause may be a stuck closed relay on the control, or something external to the control that is energizing <b>W</b> terminal when it should not be energized.</li> <li>Disconnect any wiring from the <b>W</b> terminal.</li> <li>If 24VAC is still present on the terminal, then it is a stuck relay.</li> <li>If 24VAC disappears, then there is a need to check any of the wires hooked up to the <b>W</b> terminal.</li> </ul> <p>Automatically clears after fault signal is removed.</p>
419		Critical	Equipment interface module and outdoor unit	W Output hardware Fault Lockout	<p>The <b>W</b> output has reported more than five errors.</p> <ul style="list-style-type: none"> <li>The system will shut down the outdoor unit.</li> <li>The <b>W</b> output (alert code 418) on the outdoor unit has reported more than five strikes.</li> <li>Disconnect thermostat wire from <b>W</b> and verify there is no 24VAC on the <b>W</b>.</li> <li>If 24VAC is present, replace the outdoor control.</li> </ul> <p>Automatically clears after power recycled.</p>

**Table 19. Alert Codes and Troubleshooting**

Initial notification of critical alerts will pop-up on the home screen and will be listed under notification menu. Minor and moderate alerts are found only under the notification menu. Moderate alerts are not e-mailed to Homeowners. Dealers will get an email and code can be seen on thermostat under the installer notification section.

**NOTE:** Anytime the word **DEVICE** or **DEVICE2** is used in this table, it will be replaced on all alert code notification screens with the actual offending device name, for example, thermostat, heat pump, etc.).

Alert Code	Inverter Flash Code	Priority Condition	Applicable Component	Actual Displayed Alert Text	Component or System Operational State and Troubleshooting Tip
420		Critical	Air handler or equipment interface module	Defrost Out of Control	<p>The heat pump defrost cycle has taken more than 20 minutes to complete.</p> <ul style="list-style-type: none"> <li>Defrost cycle lasts longer than 20 minutes.</li> <li>Check heat pump operation.</li> <li>This is applicable only in communicating indoor unit with non-communicating heat pump.</li> <li>Automatically clears when <b>W1</b> signal is removed.</li> </ul>
421		Critical	Equipment interface module and outdoor unit	W External Mis-wire Fault	<p>The <b>W</b> output terminal on the outdoor unit is not wired correctly. Voltage sensed on <b>W</b> output terminal when <b>Y1</b> out is deactivated. Automatically clears once voltage is not sensed on output or power is cycled.</p>
422		Moderate	Outdoor unit	Compressor Top Cap Switch Open	<p>Compressor top cap switch is exceeding thermal limit.</p> <ul style="list-style-type: none"> <li>Check condenser fan motor, TXV and indoor unit blower motor.</li> <li>Check for stuck reversing valve or clogged refrigerant filter.</li> <li><b>Lennox Variable Capacity Outdoor Units:</b> Check to ensure that one of the wires from the top cap switch has not been disconnected from one of the <b>TP</b> terminals on the outdoor control. Reconnect wire if disconnected.</li> <li>Check superheat and sub-cooling.</li> </ul> <p>Automatically clears when error is corrected.</p>
423	40	Moderate / Critical	Variable capacity outdoor unit*	OD Inverter CT Circuit Problem	<p>The inverter has detected a circuit issue.</p> <ul style="list-style-type: none"> <li>When this condition is detected the outdoor control will stop outdoor unit operations and start the anti-short cycle timer – moderate condition.</li> <li>Outdoor control will lockout unit after 10 strikes within an hour – critical condition.</li> <li>Inverter LEDs will flash code 40</li> <li>Refer to the unit service documentation for troubleshooting procedures.</li> </ul> <p>Inverter flash code 40: The sequence is:                      Red LED: Four Flashes                      Green LED: Off</p> <p>A moderate alert code will clear automatically when the inverter detects the condition no longer exist and will send a clear alert code message. To clear critical alert code disconnect power to outdoor unit and restart.</p>
424		Moderate	Outdoor unit	OD Liquid Line Sensor Faulty	<p>The liquid line temperature sensor has malfunctioned.</p> <ul style="list-style-type: none"> <li>In normal operation after outdoor control recognizes sensors, the alert code will be sent if a valid temperature reading is lost.</li> <li>Compare liquid line sensor resistance to temperature / resistance charts in unit installation instructions.</li> <li>Replace sensor pack if necessary.</li> <li>At the beginning of (any) configuration, furnace or air handler control will detect the presence of the sensor(s).</li> <li>If detected (reading in range), appropriate feature will be set as 'installed' and shown in the thermostat 'About' screen.</li> </ul> <p>Automatically clears upon configuration, or sensing normal values.</p>

**Table 19. Alert Codes and Troubleshooting**

Initial notification of critical alerts will pop-up on the home screen and will be listed under notification menu. Minor and moderate alerts are found only under the notification menu. Moderate alerts are not e-mailed to Homeowners. Dealers will get an email and code can be seen on thermostat under the installer notification section.

**NOTE:** Anytime the word **DEVICE** or **DEVICE2** is used in this table, it will be replaced on all alert code notification screens with the actual offending device name, for example, thermostat, heat pump, etc.).

Alert Code	Inverter Flash Code	Priority Condition	Applicable Component	Actual Displayed Alert Text	Component or System Operational State and Troubleshooting Tip
426		Critical	Variable capacity outdoor unit*	Excessive Inverter Alarms	<p>After 10 faults within 60 consecutive minutes, the control will lockout. Inverter will flash codes 12 to 14 and 53.</p> <p><b>NOTE:</b> The reference flash codes do not count towards this lockout condition.</p> <p>To clear disconnect power to outdoor control and restart</p>
427	21	Moderate / Critical	Variable capacity outdoor unit*	OD Inverter DC Peak Fault	<p>The inverter has detected a DC peak fault condition.</p> <ul style="list-style-type: none"> <li>If condition (55A or higher) is detected, outdoor unit will stop (compressor and fan) – moderate condition.</li> <li>Anti-short cycle is initiated.</li> <li>If peak current (55A or higher) occurs 10 times within an hour, system will lockout – critical condition.</li> <li>Inverter LEDs will flash code 21.</li> <li>If the unit is a XP20 or XP25 variable capacity heat pump, this error may occur entering or exiting a defrost cycle as the compressor restarts after the 30 second compressor shift delay. If the unit was manufactured prior to 5817F and has frequent alert code 427, then compare the inverter part number to the latest part number listed in the unit repair parts. Units produced after 5817F have an inverter with updated software that includes compressor current slope logic to reduce the potential of alert code 427 instances from occurring during defrost. Replace the inverter with the latest inverter if necessary.</li> <li>Refer to the unit service documentation for detailed troubleshooting procedures.</li> </ul> <p>Inverter flash code 21. The sequence is:</p> <ul style="list-style-type: none"> <li>Red LED: Two Flashes</li> <li>Green LED: One Flash</li> </ul> <p>To clear, disconnect and reconnect power to outdoor control.</p>
428	22	Moderate / Critical	Variable capacity outdoor unit*	OD Inverter High Main Input Current	<p>The inverter has detected a high main input current condition.</p> <ul style="list-style-type: none"> <li>If condition is detected, outdoor unit will stop (compressor and fan) – moderate condition.</li> <li>Anti-short cycle is initiated.</li> <li>If condition occurs 10 times within an hour, system will lockout – critical condition.</li> <li>Inverter LEDs will flash code 22.</li> <li>Refer to the unit service documentation for detailed troubleshooting procedures.</li> </ul> <p>Inverter flash code 22. The sequence is:</p> <ul style="list-style-type: none"> <li>Red LED: Two Flashes</li> <li>Green LED: Two Flashes</li> </ul> <p>To clear, disconnect power to outdoor unit and restart.</p>



**Table 19. Alert Codes and Troubleshooting**

Initial notification of critical alerts will pop-up on the home screen and will be listed under notification menu. Minor and moderate alerts are found only under the notification menu. Moderate alerts are not e-mailed to Homeowners. Dealers will get an email and code can be seen on thermostat under the installer notification section.

**NOTE:** Anytime the word **DEVICE** or **DEVICE2** is used in this table, it will be replaced on all alert code notification screens with the actual offending device name, for example, thermostat, heat pump, etc.).

Alert Code	Inverter Flash Code	Priority Condition	Applicable Component	Actual Displayed Alert Text	Component or System Operational State and Troubleshooting Tip
429	23	Moderate / Critical	Variable capacity outdoor unit*	OD Inverter DC Link Low Voltage	<p>The inverter has detected a DC link low voltage condition.</p> <ul style="list-style-type: none"> <li>On a call for compressor operation, if DC link power in inverter does not rise above 180 VDC for 2- and 3-ton models, 250 VDC for 4- and 5-ton models within 30 seconds, the control will display a moderate code.</li> <li>If condition is detected, outdoor unit will stop (compressor and fan) – moderate condition.</li> <li>An anti-short cycle timer is initiated. If condition occurs 10 times within a 60 consecutive minutes, system will lock out and display alert code 429 – critical condition.</li> <li>The outdoor control anti-short cycle timer will time out and the unit will recycle the demand.</li> <li>Inverter LEDs will flash code 23.</li> <li>Refer to the unit service documentation for detailed troubleshooting procedures. Perform test function and verify inverter DC link and line input voltage and current. Also check input to filter board and reactor before replacing inverter board. To perform this test, go to <b>menu &gt; settings &gt; advanced settings &gt; view dealer control center &gt; tests</b>.</li> </ul> <p>Inverter flash code 23. The sequence is:</p> <ul style="list-style-type: none"> <li>Red LED: Two Flashes</li> <li>Green LED: Three Flashes</li> </ul> <p>Automatically clears when the system detects that the issue no longer exists.</p> <p><b>Troubleshooting Suggestions:</b></p> <ul style="list-style-type: none"> <li><b>Check wire connections (U, V and W) at inverter plug in harness and compressor.</b></li> <li><b>Check the resistance of compressor windings. If not in range, replace compressor.</b></li> <li>Check compressor to ground. If ground issue, replace compressor.</li> <li>Check input power (Single Phase - 208/230VAC <math>\pm</math> 10%. If out of range, correct main power issue.</li> <li>Check DC Link voltage and MICOM Sensing voltage. If out of range, replace inverter. If okay, possible mechanical issue with compressor.</li> </ul> <p>Go to outdoor unit service manual for detail troubleshooting procedures and require values for testing DC link voltages and various insulation resistance characteristics.</p>

**Table 19. Alert Codes and Troubleshooting**

Initial notification of critical alerts will pop-up on the home screen and will be listed under notification menu. Minor and moderate alerts are found only under the notification menu. Moderate alerts are not e-mailed to Homeowners. Dealers will get an email and code can be seen on thermostat under the installer notification section.

**NOTE:** Anytime the word **DEVICE** or **DEVICE2** is used in this table, it will be replaced on all alert code notification screens with the actual offending device name, for example, thermostat, heat pump, etc.).

Alert Code	Inverter Flash Code	Priority Condition	Applicable Component	Actual Displayed Alert Text	Component or System Operational State and Troubleshooting Tip
430	26	Moderate / Critical	Variable capacity outdoor unit*	OD Inverter Compressor Startup Fail	<p>Compressor start-up failure.</p> <ul style="list-style-type: none"> <li>• If condition is detected, outdoor unit will stop (compressor and fan) – moderate condition.</li> <li>• Anti-short cycle is initiated.</li> <li>• If condition occurs 10 times within 60 consecutive minutes, the system will lockout – critical condition.</li> <li>• Inverter LEDs will flash code 26.</li> <li>• Refer to the unit service documentation for detailed troubleshooting procedures.</li> </ul> <p><b>Inverter flash code 26.</b></p> <p>The sequence is:</p> <ul style="list-style-type: none"> <li>• Red LED: Two Flashes</li> <li>• Green LED: Six Flashes</li> </ul> <p><b>NOTE:</b> Inverter normal operations with no error code present is as follows. Red LED is ON and Green LED is OFF.</p> <ul style="list-style-type: none"> <li>• Check refrigerant</li> <li>• Replace outdoor control board</li> <li>• Replace inverter.</li> </ul> <p>To clear, disconnect power to outdoor unit and restart.</p>
431	27	Moderate / Critical	Variable capacity outdoor unit*	OD Inverter PFC Fault	<p>The inverter has detected a PFC circuit over-current condition.</p> <ul style="list-style-type: none"> <li>• Error occurs when PFC detects an over current condition of 100A peak.</li> <li>• If condition is detected, outdoor unit will stop (compressor and fan) – moderate condition.</li> <li>• Anti-short cycle timer is initiated.</li> <li>• If condition occurs 10 times within 60 consecutive minutes, the system will lockout – critical condition.</li> <li>• Inverter LEDs will flash code 27.</li> <li>• Refer to the unit service documentation for detailed troubleshooting procedures.</li> </ul> <p>Inverter flash code 27. The sequence is:</p> <ul style="list-style-type: none"> <li>• Red LED: Two Flashes</li> <li>• Green LED: Seven Flashes</li> </ul> <p>To clear, disconnect power to outdoor unit and restart.</p>

**Table 19. Alert Codes and Troubleshooting**

Initial notification of critical alerts will pop-up on the home screen and will be listed under notification menu. Minor and moderate alerts are found only under the notification menu. Moderate alerts are not e-mailed to Homeowners. Dealers will get an email and code can be seen on thermostat under the installer notification section.

**NOTE:** Anytime the word **DEVICE** or **DEVICE2** is used in this table, it will be replaced on all alert code notification screens with the actual offending device name, for example, thermostat, heat pump, etc.).

Alert Code	Inverter Flash Code	Priority Condition	Applicable Component	Actual Displayed Alert Text	Component or System Operational State and Troubleshooting Tip
432	28	Moderate / Critical	Variable capacity outdoor unit*	OD Inverter DC Link High Voltage	<p>The inverter has detected a DC link high voltage condition.</p> <ul style="list-style-type: none"> <li>• Error occurs when the DC link capacitor voltage is greater than 480VDC.</li> <li>• If condition is detected, outdoor unit will stop (compressor and fan) – moderate condition.</li> <li>• Anti-short cycle timer is initiated.</li> <li>• If condition occurs 10 times within 60 consecutive minutes, the system will lockout – critical condition.</li> <li>• Inverter LEDs will flash code 28.</li> <li>• Refer to the unit service documentation for detailed troubleshooting procedures.</li> </ul> <p>Inverter flash code 28., The sequence is:</p> <ul style="list-style-type: none"> <li>• Red LED: Two Flashes</li> <li>• Green LED: Eight Flashes</li> </ul> <p>To clear, disconnect power to outdoor unit and restart.</p> <p><b>Troubleshooting Suggestions:</b></p> <ul style="list-style-type: none"> <li>• <b>Check wire connections (U, V and W) at inverter plug in harness and compressor.</b></li> <li>• <b>Check the resistance of compressor windings. If not in range, replace compressor.</b></li> <li>• Check compressor to ground. If ground issue, replace compressor.</li> <li>• Check input power (Single Phase - 208/230VAC ± 10%. If out of range, correct main power issue.</li> <li>• Check DC Link voltage and MICOM Sensing voltage. If out of range, replace inverter. if okay, possible mechanical issue with compressor.</li> </ul> <p>Go to outdoor unit service manual for detail troubleshooting procedures and require values for testing DC link voltages and various insulation resistance characteristics.</p>

**Table 19. Alert Codes and Troubleshooting**

Initial notification of critical alerts will pop-up on the home screen and will be listed under notification menu. Minor and moderate alerts are found only under the notification menu. Moderate alerts are not e-mailed to Homeowners. Dealers will get an email and code can be seen on thermostat under the installer notification section.

**NOTE:** Anytime the word **DEVICE** or **DEVICE2** is used in this table, it will be replaced on all alert code notification screens with the actual offending device name, for example, thermostat, heat pump, etc.).

Alert Code	Inverter Flash Code	Priority Condition	Applicable Component	Actual Displayed Alert Text	Component or System Operational State and Troubleshooting Tip
433	29	Moderate / Critical	Variable capacity outdoor unit*	OD Inverter Compressor Over-current	<p>Compressor phase current is too high.</p> <ul style="list-style-type: none"> <li>• Error occurs when compressor peak phase current is greater than 28A.</li> <li>• Inverter will issue inverter code 14 first and slow down to try to reduce the current.</li> <li>• If the current remains high, outdoor unit will stop (compressor and fan) – moderate condition.</li> <li>• Cycle timer is initiated.</li> <li>• If condition occurs 5 times within 60 consecutive minutes, the system will lockout – critical condition.</li> <li>• This alert code may be triggered by the inverter or the Lennox variable capacity outdoor (inverter controlled) unit.</li> <li>• Lennox outdoor control may trigger an this alert code if the inverter reduces the compressor speed which is identified as a alert code 441 and the compressor speed (in hz) is below the minimum speed. This will typically occur at start-up. The inverter automatically increases the compressor minimum speed below 45°F in the heating mode and above 115°F ensure the compressor capacity is sufficient for oil return. If alert code 433 occurs and inverter does not indicate an inverter code 29, the Lennox communicating Lennox outdoor control triggered the alert code 433.</li> </ul> <p>&gt; Check the Lennox outdoor control software version by accessing the outdoor unit diagnostics section of the icomfort thermostat. The Lennox outdoor control with software versions 1.27 and later have updated software that includes a six minute time delay during the cooling mode and a 11 minute delay during the heating mode after receiving an alert code 433, which typically occurs during start-up.</p> <p>&gt; If the system is connected to the Internet, the Lennox outdoor control can be updated over the Internet. Make sure the software “auto update” is enabled. The software “auto update” can be toggled to prompt the Lennox server to update the thermostat which will update the Lennox outdoor control. If the system is not connected to the Internet, replace the Lennox outdoor control with 103686-07 (17D27) or later version.</p> <ul style="list-style-type: none"> <li>• Inverter LEDs will flash code 29.</li> <li>• Refer to the unit service documentation for detailed troubleshooting procedures.</li> </ul> <p>Inverter flash code 29. The sequence is:</p> <ul style="list-style-type: none"> <li>• Red LED: Two Flashes</li> <li>• Green LED: Nine Flashes</li> </ul> <p>To clear alert code disconnect power to both the indoor and outdoor units and then reconnect power. Restart system..</p>

**Table 19. Alert Codes and Troubleshooting**

Initial notification of critical alerts will pop-up on the home screen and will be listed under notification menu. Minor and moderate alerts are found only under the notification menu. Moderate alerts are not e-mailed to Homeowners. Dealers will get an email and code can be seen on thermostat under the installer notification section.

**NOTE:** Anytime the word **DEVICE** or **DEVICE2** is used in this table, it will be replaced on all alert code notification screens with the actual offending device name, for example, thermostat, heat pump, etc.).

Alert Code	Inverter Flash Code	Priority Condition	Applicable Component	Actual Displayed Alert Text	Component or System Operational State and Troubleshooting Tip
434	53	Moderate / Critical	Variable capacity outdoor unit*	OD Inverter Comm Error to Main Control	<ul style="list-style-type: none"> <li>Outdoor control has lost communications with the inverter for greater than three minutes.</li> <li>Outdoor control will stop all compressor demands – moderate condition.</li> <li>This alert code will occur if the outdoor unit power is turned off and the indoor unit power (24VAC to Lennox outdoor control) remains on, or if the indoor unit power is turned off (24VAC to Lennox outdoor control) and the outdoor unit power is on. This could occur while performing service or maintenance procedures on the indoor or outdoor unit.</li> <li>The Lennox outdoor control will attempt to re-establish communication to the inverter when the alert code 434 occurs by cycling the outdoor unit contactor off for two minutes. Upon energizing the contactor the Lennox outdoor control will attempt to communicate to the inverter for three minutes. This process will be repeated three times in attempt to establish communication before locking out.</li> <li>If the unit is locked out with a critical alert code 434, reset the system by cycling the outdoor unit power off and back on. Then cycle the indoor power off (24vac to the Lennox outdoor control) and then back on.</li> <li>If this occurs three times in one thermostat call, the outdoor unit will lock out and display alert code 434 – critical condition.</li> <li>Check for loose or disconnected electrical connections.</li> <li>Interruption of main power to inverter.</li> <li>Inverter LEDs will flash code 53.</li> <li>Refer to the unit service documentation for detailed troubleshooting procedures.</li> </ul> <p>Inverter flash code 53., The sequence is:</p> <ul style="list-style-type: none"> <li>Red LED: Five Flashes</li> <li>Green LED: Three Flashes</li> </ul> <p>Automatically clears when the system detects that the issue no longer exists. If the unit is locked out with a critical alert code 434, reset the system by first cycling the outdoor unit power off and back. Then cycle the indoor power off (24VAC to the Lennox outdoor control) and then back on.</p>
435	60	Moderate / Critical	Variable capacity outdoor unit*	OD Inverter EEPROM Checksum fault	<p>Inverter internal error.</p> <ul style="list-style-type: none"> <li>When this error occurs, the outdoor control will cycle power to the inverter by opening the contactor for two minutes – moderate condition.</li> <li>Outdoor control will cycle power to the inverter three times and then outdoor unit is locked out – critical condition.</li> <li>Inverter LEDs will flash code 60.</li> <li>Refer to the unit service documentation for detailed troubleshooting procedures.</li> </ul> <p>Inverter flash code 60. The sequence is:</p> <ul style="list-style-type: none"> <li>Red LED: Six Flashes</li> <li>Green LED: Off</li> </ul> <p>To clear alert code disconnect power to outdoor unit and restart.</p>

**Table 19. Alert Codes and Troubleshooting**

Initial notification of critical alerts will pop-up on the home screen and will be listed under notification menu. Minor and moderate alerts are found only under the notification menu. Moderate alerts are not e-mailed to Homeowners. Dealers will get an email and code can be seen on thermostat under the installer notification section.

**NOTE:** Anytime the word **DEVICE** or **DEVICE2** is used in this table, it will be replaced on all alert code notification screens with the actual offending device name, for example, thermostat, heat pump, etc.).

Alert Code	Inverter Flash Code	Priority Condition	Applicable Component	Actual Displayed Alert Text	Component or System Operational State and Troubleshooting Tip
436	62	Moderate / Critical	Variable capacity outdoor unit*	OD Inverter High Heat-Sink Temperature	<p>Inverter heat sink temperature exceeded limit.</p> <ul style="list-style-type: none"> <li>This occurs when the heat sink temperature exceeds the inverter limit. Inverter will issue inverter alert code 13 first and slow down to try to cool the heat sink.</li> <li>If temperature remains high, outdoor unit will stop both compressor and fan – moderate condition.</li> <li>Anti-short cycle is initiated.</li> <li>If condition occurs five times within an hour, system will lockout – critical condition.</li> <li>The screws that hold the inverter to the inverter board were loose causing poor contact between these two components.</li> <li>Tighten screws that hold the heat sink to the inverter control board.</li> </ul> <p><b>NOTE:</b> Wait five minutes for all capacitors to discharge before checking screws.</p> <ul style="list-style-type: none"> <li>Inverter LEDs will flash code 62.</li> <li>Refer to the unit service documentation for detailed troubleshooting procedures.</li> </ul> <p>Inverter flash code 62. The sequence is:</p> <ul style="list-style-type: none"> <li>Red LED: Six Flashes</li> <li>Green LED: Two Flashes</li> </ul> <p>Moderate condition will automatically clear when the inverter sends an alert code clear message. Critical condition is cleared by disconnecting power to the outdoor unit and restart.</p>
437	65	Moderate / Critical	Variable capacity outdoor unit*	OD Inverter Heat-Sink temp Sensor Fault	<p>Heat sink temperature sensor fault has occurred (temperature less than 4°F or greater than 264°F after 10 minutes of operation).</p> <ul style="list-style-type: none"> <li>When the temperature sensor detects a temperature less than 4°F or greater than 264°F after 10 minutes of operation.</li> <li>Outdoor unit will stop both compressor and fan – moderate condition.</li> <li>Anti-short cycle is initiated.</li> <li>If condition occurs five times within an hour, system will lockout – critical condition.</li> <li>Inverter LEDs will flash code 65.</li> <li>Refer to the unit service documentation for detailed troubleshooting procedures.</li> </ul> <p>Inverter flash code 65. The sequence is:</p> <ul style="list-style-type: none"> <li>Red LED: Six Flashes</li> <li>Green LED: Five Flashes</li> </ul> <p>Moderate priority condition will automatically clear when the inverter sends an alert code clear message. Critical priority condition can be cleared by disconnecting and reconnecting power to outdoor unit to restart.</p>

**Table 19. Alert Codes and Troubleshooting**

Initial notification of critical alerts will pop-up on the home screen and will be listed under notification menu. Minor and moderate alerts are found only under the notification menu. Moderate alerts are not e-mailed to Homeowners. Dealers will get an email and code can be seen on thermostat under the installer notification section.

**NOTE:** Anytime the word **DEVICE** or **DEVICE2** is used in this table, it will be replaced on all alert code notification screens with the actual offending device name, for example, thermostat, heat pump, etc.).

Alert Code	Inverter Flash Code	Priority Condition	Applicable Component	Actual Displayed Alert Text	Component or System Operational State and Troubleshooting Tip
438	73	Moderate / Critical	Variable capacity outdoor unit*	OD Inverter PFC Input Overcurrent	<p>The inverter has detected a power factor correction (PFC) circuit over-current condition.</p> <ul style="list-style-type: none"> <li>The inverter has detected an PFC over current condition. This may be caused by a high load condition, high pressure, or outdoor fan failure.</li> <li>Outdoor control will display the code when the inverter has detected the error – moderate condition.</li> <li>After three minutes, the inverter will reset and the compressor will resume operation.</li> <li>If the error condition occurs 10 times within a 60 minute rolling time period, the outdoor unit control will lock out operation of the outdoor unit – critical condition.</li> <li>Possible issue is system running at high pressures.</li> <li>Check for high pressure trips or other alert codes in thermostat and outdoor control.</li> <li>Inverter LEDs will flash code 73.</li> <li>Refer to the unit service documentation for detailed troubleshooting procedures.</li> </ul> <p>Inverter flash code 73. The sequence is:</p> <ul style="list-style-type: none"> <li>Red LED: Seven Flashes</li> <li>Green LED: Three Flashes</li> </ul> <p>Moderate priority condition is automatically cleared when the inverter sends a clear message. Critical priority condition will automatically clear when inverter is power cycled.</p>
439	12	Moderate	Variable capacity outdoor unit*	OD Inverter Compressor Slowdown - High Input Current	<p>Compressor slowdown due to high input current.</p> <ul style="list-style-type: none"> <li>Input current is approaching a high limit.</li> <li>Compressor speed will automatically slow down. The outdoor control will continue sending the inverter speed demanded by the thermostat.</li> <li>The outdoor control will set indoor CFM and outdoor RPM to values according to demand percentage rather than the actual Hz.</li> <li>Inverter LEDs will flash code 12.</li> <li>Refer to the unit service documentation for detailed troubleshooting procedures.</li> </ul> <p>Inverter flash code 12. The sequence is:</p> <ul style="list-style-type: none"> <li>Red LED: One Flash</li> <li>Green LED: Two Flashes</li> </ul> <p>Automatically clears when the condition no longer exists.</p>

**Table 19. Alert Codes and Troubleshooting**

Initial notification of critical alerts will pop-up on the home screen and will be listed under notification menu. Minor and moderate alerts are found only under the notification menu. Moderate alerts are not e-mailed to Homeowners. Dealers will get an email and code can be seen on thermostat under the installer notification section.

**NOTE:** Anytime the word **DEVICE** or **DEVICE2** is used in this table, it will be replaced on all alert code notification screens with the actual offending device name, for example, thermostat, heat pump, etc.).

Alert Code	Inverter Flash Code	Priority Condition	Applicable Component	Actual Displayed Alert Text	Component or System Operational State and Troubleshooting Tip
440	13	Moderate	Variable capacity outdoor unit*	OD Inverter Compressor Slowdown - High Heat-Sink temperature	<p>Compressor slowdown due to high heat sink temperature.</p> <ul style="list-style-type: none"> <li>Heat sink temperature is approaching limit.</li> <li>The compressor speed automatically slows to reduce heat sink temperature.</li> <li>The control sets indoor CFM and outdoor RPM to values according to demand percentage rather than the actual Hz.</li> <li>The screws that hold the inverter to the inverter board may be loose causing poor contact between these two components.</li> <li>Tighten screws that hold the heat sink to the inverter control board.</li> </ul> <p><b>NOTE:</b> Wait five minutes for all capacitors to discharge before checking screws.</p> <ul style="list-style-type: none"> <li>This error code is primarily for informational purposes as the inverter controls the compressor speed to operate within design parameters. Typically the inverter will make a minor speed reduction of 4 Hz (approximately a 5-6% speed reduction) for a brief period of time and to reduce the heat sink temperature and will then resume normal operation. This may occur at high outdoor temperatures (above 110°F) for brief periods of time (3 – 4 minutes) and is normal and expected operation of the inverter controlling the compressor safely within design parameters.</li> <li>The inverter finned aluminum heat sink is located on the back side of the inverter in the condenser air stream. If the alert code 440 occur frequently, especially at lower outdoor temperatures, check the heat sink for debris that may reduce heat transfer or possible obstructions that may impact air flow across the heat sink.</li> <li>The inverter will begin to briefly reduce the compressor speed when the heat sink temperature rises above 185°F and will allow the inverter to resume the requested compressor demand speed once the inverter heat sink reaches 176°F. The heat sink temperature, compressor speed in Hertz &amp; the Inverter Compressor Speed Reduction status (“On” or “Off”) notification can be viewed under the outdoor unit Diagnostics section of the thermostat Dealer Control Center.</li> <li>Inverter LEDs will flash code 13.</li> <li>Refer to the unit service documentation for detailed troubleshooting procedures.</li> </ul> <p>Inverter flash code 13. The sequence is:</p> <ul style="list-style-type: none"> <li>Red LED: One Flash</li> <li>Green LED: Three Flashes</li> </ul> <p>Automatically clears when the condition no longer exists.</p>



**Table 19. Alert Codes and Troubleshooting**

Initial notification of critical alerts will pop-up on the home screen and will be listed under notification menu. Minor and moderate alerts are found only under the notification menu. Moderate alerts are not e-mailed to Homeowners. Dealers will get an email and code can be seen on thermostat under the installer notification section.

**NOTE:** Anytime the word **DEVICE** or **DEVICE2** is used in this table, it will be replaced on all alert code notification screens with the actual offending device name, for example, thermostat, heat pump, etc.).

Alert Code	Inverter Flash Code	Priority Condition	Applicable Component	Actual Displayed Alert Text	Component or System Operational State and Troubleshooting Tip
441	14	Moderate	Variable capacity outdoor unit*	OD Inverter Compressor Slowdown - High Compressor Current	<p>This alert code is for more information than an issue with the system.</p> <ul style="list-style-type: none"> <li>Compressor slowdown due to high compressor current.</li> <li>Compressor current is approaching limit.</li> <li>The compressor speed automatically slows.</li> <li>This error code is primarily for informational purposes as the inverter controls the compressor to operate within design parameters. Alert code 441 typically occurs at startup as the compressor current increases rapidly during startup.</li> <li>The inverter will reduce the compressor speed by 4 Hz and slow the compressor ramp up speed to the requested compressor demand speed (capacity). This is normal and expected operation of the inverter to control the inverter within design parameters. In most cases the alert code 441 notification does not require any additional service or diagnostic procedures.</li> <li>The control sets indoor CFM and outdoor RPM to values according to demand percentage rather than the actual Hz.</li> <li>Possible issue is system running at high pressures.</li> <li>Check for high pressure trips or other alert codes in thermostat and outdoor control.</li> <li>Inverter LEDs will flash code 14.</li> <li>Refer to the unit service documentation for detailed troubleshooting procedures.</li> </ul> <p>Inverter flash code 14. The sequence is:</p> <ul style="list-style-type: none"> <li>Red LED: One Flash</li> <li>Green LED: Four Flashes</li> </ul> <p>Automatically clears when the condition no longer exists.</p>
442		Critical	Outdoor unit	Compressor Top Cap Switch Strike Lockout	<p>The top cap switch has opened five times within one hour. As a result, the outdoor unit is locked out.</p> <ul style="list-style-type: none"> <li>This condition occurs when compressor thermal protection sensor opens five times within one hour.</li> <li>Outdoor unit will stop.</li> <li>To clear, disconnect power to outdoor unit and restart.</li> </ul>
443		Critical	Outdoor unit	MUC Unit Code to Inverter Model Mismatch	<p>The Lennox variable capacity unitary control (outdoor control) has incorrect appliance unit size code selected.</p> <ul style="list-style-type: none"> <li>Check for proper configuring under unit size code used for outdoor unit (see unit configuration guide or in installation instructions).</li> <li>If replacing inverter, verify inverter model matches unit size.</li> <li>Remove the thermostat from the system while applying power and reprogramming.</li> <li>Automatically clears after the correct match is detected following a power reset.</li> </ul>
444		Critical	Heat Pump	Reversing Valve Relay Failed to Close	<p>Relay failure. Verify by call for heat pump heating. Check for 24VAC out from <b>O</b>. Replace outdoor unit control board.</p>

**Table 19. Alert Codes and Troubleshooting**

Initial notification of critical alerts will pop-up on the home screen and will be listed under notification menu. Minor and moderate alerts are found only under the notification menu. Moderate alerts are not e-mailed to Homeowners. Dealers will get an email and code can be seen on thermostat under the installer notification section.

**NOTE:** Anytime the word **DEVICE** or **DEVICE2** is used in this table, it will be replaced on all alert code notification screens with the actual offending device name, for example, thermostat, heat pump, etc.).

Alert Code	Inverter Flash Code	Priority Condition	Applicable Component	Actual Displayed Alert Text	Component or System Operational State and Troubleshooting Tip
500		Minor (Escalated to Critical after alert code persists for 15 minutes)	PureAir S	Press Sensor Fault	Pressure sensor reports a fault for more than 5 minutes, or does not respond for more than 5 minutes. Device will not perform any pressure reading calculations until fault is recovered. Remaining filter life display will indicate “-“ while fault exists. Automatically clears 30 seconds after fault is recovered.
501		Minor (Escalated to Critical after alert code persists for 15 minutes)	PureAir S	UV Sensor Fault	Ultra-violet (UV) sensor reports a fault for more than 5 minutes or UV sensor does not respond for more than 5 minutes. Device will not perform any UV lamp life remaining calculations until fault has recovered. Life remaining display shall indicate “-“ while fault exists. Automatically clears 30 seconds after fault is recovered.
502		Critical	PureAir S	UV Lamp Off	The light is determined to be off when the last three last light intensities measurements are below the set threshold. Light is determined on after 1 set of five samples are above the set threshold.
503		Moderate	PureAir S	Filter life at 10%	Filter life remaining determined to be <=10%, but greater than 0%.
504		Critical	PureAir S	Filter Life at 0%	Filter life remaining determined to be 0%.
505		Moderate	PureAir S	PureAir Model Selection Changed	Model Selection jumper has changed positions. Jumper repositioned back to original jumper position or system rebooted.
506		Critical	PureAir S	UV Lamp Life at 0%	Ultra violet lamp life is at 0%.
507		Critical	PureAir S	Filter Calibration Failure	Filter calibration determined failed due to all test cfm static pressures reading <= 7 Pa. Send alert code immediately. No filter tests or life calculation occur while this alert code is active. Clear alert code upon initiation of another filter calibration.
530		Moderate	iHarmony	Low Damper 24VAC Voltage	<ul style="list-style-type: none"> <li>• Check 24VAC voltage to all dampers.</li> <li>• Check 24VAC damper transformer.</li> <li>• Check connections.</li> </ul> Replace transformer if applicable.

**Table 19. Alert Codes and Troubleshooting**

Initial notification of critical alerts will pop-up on the home screen and will be listed under notification menu. Minor and moderate alerts are found only under the notification menu. Moderate alerts are not e-mailed to Homeowners. Dealers will get an email and code can be seen on thermostat under the installer notification section.

**NOTE:** Anytime the word **DEVICE** or **DEVICE2** is used in this table, it will be replaced on all alert code notification screens with the actual offending device name, for example, thermostat, heat pump, etc.).

Alert Code	Inverter Flash Code	Priority Condition	Applicable Component	Actual Displayed Alert Text	Component or System Operational State and Troubleshooting Tip
532		Moderate	iHarmony	Zoning Pressure Switch Opened (High Pressure)	<p>Zoning Pressure Switch Opened (high pressure).</p> <ul style="list-style-type: none"> <li>Compressor pressure is above the specified limit.</li> <li>Compressor is turned off.</li> <li>Zoning will be restored once the high pressure switch closes.</li> </ul> <p>Occasionally we get this with an AC system and the fix is to just jump out the pressure switch terminals on the damper control module board. Automatically clears after compressor pressure is within limits.</p>
542		Moderate/ Critical	iHarmony Zone Sensor 1	Zone 1 Temp Sensor Problem	<p>Possible Causes:</p> <ul style="list-style-type: none"> <li>Zone temperature sensor reading out of range.</li> <li>Check for loose or incorrectly wired connections at the zone sensor or damper control module terminals.</li> <li>Open or short zone temperature sensor detected for more than five second.</li> <li>More than one zone sensor has the same assigned zone number. Check zone sensor(s) zone number assignment.</li> </ul> <p>System Response:</p> <ul style="list-style-type: none"> <li>Both types of zone sensors will display "--" as the indoor temperature on the main screen.</li> <li>Damper control module will operate in central mode (all dampers open) in both moderate and critical priority conditions.</li> <li>If after 10 minutes the condition does not change, the applicable alert code (542, 543, 544 or 545) is escalate by the Lennox communicating thermostat to critical. System will continue to operate in central mode.</li> <li>At the Lennox communicating thermostat, only zone 1 screen will be available.</li> </ul>
543		Moderate/ Critical	iHarmony Zone Sensor 2	Zone 2 Temp Sensor Problem	
544		Moderate/ Critical	iHarmony Zone Sensor 3	Zone 3 Temp Sensor Problem	
545		Moderate/ Critical	iHarmony Zone Sensor 4	Zone 4 Temp Sensor Problem	<p><b>NOTE:</b> The Lennox communicating thermostat will display the alert code as "Problem (Zoning Control)". Email notifications will describe the issue as "Zone "X" Temp Sensor Problem."</p> <p>Automatically clears 30 seconds after condition no longer exist.</p>
551		Critical	Zone Sensor and iHarmony	Lost Communications	<p>Any lost communication between any zone sensor and the damper control module will result in applicable alert code(s) being displayed (543, 544 or 545) at the thermostat.</p> <ul style="list-style-type: none"> <li>A pop-up display on the thermostat will appear indicating a communication error.</li> <li>Indoor temperature for the specific zone in error will displayed as "--" on the home screen.</li> <li>When any zone sensor loses communication with the damper control module, the entire system will go into central mode (single temperature control).</li> </ul> <p>Check for loose, damage or incorrect wiring between damper control module and the zone sensor reporting alert code 551. Once communication is reestablished the zone sensor will return to normal zone operations.</p>
594		Moderate / Critical	Equipment interface module	Pre-Coil Air temp Sensor Problem	<p>Pre-coil discharge air temperature sensor problem (dual-fuel mode only). This alert code will escalate from moderate to critical after ten (10) minutes. This may result in no heating or cooling operations.</p> <p>Possible cause for alert code 594 is the interlock relay is energized, but no input is sensed after three seconds. This may be resolve by de-energizing the interlock relay and re-energized five minutes later if demand is still present. Alert code automatically clears five minutes after fault is cleared.</p>

**Table 19. Alert Codes and Troubleshooting**

Initial notification of critical alerts will pop-up on the home screen and will be listed under notification menu. Minor and moderate alerts are found only under the notification menu. Moderate alerts are not e-mailed to Homeowners. Dealers will get an email and code can be seen on thermostat under the installer notification section.

**NOTE:** Anytime the word **DEVICE** or **DEVICE2** is used in this table, it will be replaced on all alert code notification screens with the actual offending device name, for example, thermostat, heat pump, etc.).

Alert Code	Inverter Flash Code	Priority Condition	Applicable Component	Actual Displayed Alert Text	Component or System Operational State and Troubleshooting Tip
610		Critical	HD Display (Thermostat)	Low Room Temperature Detected	This alert will automatically notified the user that a low room temperature condition exist. A notification is displayed on the HD Display and email notification sent to homeowner and dealer. The freeze alert protection parameter range is 30°F to 50°F (-1.11 to 10.0°C). Default is 40°F (4.44°C). <b>NOTE:</b> Notification is dependent on the thermostat having an active Wi-Fi connection and the user account has been setup and includes a valid email address. Automatically clears when condition is resolved.
611		Critical	HD Display (Thermostat)	High Room Temperature Detected	This alert will automatically notified the user that a high room temperature condition exist. A notification is displayed on the HD Display and email notification sent to homeowner and dealer. The heat alert protection parameter range is 80°F to 100°F (26.67 to 37.78°C). Default is 90°F (32.22°C). <b>NOTE:</b> Notification is dependent on the thermostat having a active Wi-Fi connection and the user account has been setup and includes a valid email address. Automatically clears when condition is resolved.
700		Critical	HD Display (Thermostat)	Comfort Sensor Temp Sensor Problem	The internal temperature sensor of the HD Display is not operating correctly. To resolve this issue, try the following: <ul style="list-style-type: none"> <li>Remove HD display from subbase and reattach</li> <li>Seal hole in wall behind subbase to minimize exposure to unconditioned air from inside the wall.</li> <li>Run <b>“reset all”</b> under Dealer Control Center.</li> <li>If issue persist, then replace the HD Display.</li> </ul> Automatically clears when the system detects that the issue no longer exists.
701		Moderate	HD Display (Thermostat)	TSTAT Temp Above Limit	The thermostat is reading indoor temperatures above the pre-programmed limit. The thermostat has a built-in non-adjustable high limit of 99°F. <ul style="list-style-type: none"> <li>Cool thermostat.</li> <li>Adjust set point.</li> <li>Run <b>reset all</b> under Dealer Control Center.</li> <li>Replace HD Display if needed.</li> </ul> Automatically clears when the system detects that the issue no longer exists.
900		Moderate	HD Display (Thermostat)	Temperature Control Problem	Something is causing the system not to be able to reach set point. Check for dirty coil, low refrigerant or verify the system is not under size for the application. Automatically clears when the system detects that the issue no longer exists.
901		Moderate (On/Off) Default	HD Display (Thermostat)	Smart Alert Modes: Heating & Cooling (Smart)	This alert occurs when temperature consistently diverges away from set-point in the following two conditions: <ul style="list-style-type: none"> <li>When system is running high stage/full speed.</li> <li>When the system is not providing demand when there is a call for one. Typically when system locked out.</li> <li>The Cooling capacity alert doesn't work in zoning.</li> <li>If alert code exist must be manually cleared.</li> </ul>

**Table 19. Alert Codes and Troubleshooting**

Initial notification of critical alerts will pop-up on the home screen and will be listed under notification menu. Minor and moderate alerts are found only under the notification menu. Moderate alerts are not e-mailed to Homeowners. Dealers will get an email and code can be seen on thermostat under the installer notification section.

**NOTE:** Anytime the word **DEVICE** or **DEVICE2** is used in this table, it will be replaced on all alert code notification screens with the actual offending device name, for example, thermostat, heat pump, etc.).

Alert Code	Inverter Flash Code	Priority Condition	Applicable Component	Actual Displayed Alert Text	Component or System Operational State and Troubleshooting Tip
65539		Critical	HD Display (Thermostat)	Missing TSTAT	<ul style="list-style-type: none"> <li>• HD Wall Display not detected for more than 30 seconds.</li> <li>• Flashing blue LED will appear if not communicating with smart hub.</li> </ul> <p>Typically the thermostat will send a command to the unknown device and place it in a soft disable state. The Lennox communicating control with the soft disable state will indicate so as follows:</p> <ul style="list-style-type: none"> <li>• On air handler, furnace and outdoor controls, the state is displayed by double horizontal lines on seven-segment display.</li> <li>• On the damper control module, the green LED will flash 3 seconds ON and 1 second OFF.</li> <li>• On the equipment interface module, the green LED will flash 3 seconds ON and 1 second OFF.</li> </ul> <p>Cycling power to the soft disabled control may clear the condition. If cycling power does not clear the soft disable state then replace control. Automatically clears once is detected for two seconds.</p>
65543		Info	HD Display (Thermostat)	Firmware updated	<p>When new firmware has been successfully updated to the thermostat. Typically the thermostat will send a command to the unknown device and place it in a soft disable state. The Lennox communicating control with the soft disable state will indicate so as follows:</p> <ul style="list-style-type: none"> <li>• On air handler, furnace and outdoor controls, the state is displayed by double horizontal lines on seven-segment display.</li> <li>• On the damper control module, the green LED will flash 3 seconds ON and 1 second OFF.</li> <li>• On the equipment interface module, the green LED will flash 3 seconds ON and 1 second OFF.</li> </ul> <p>Cycling power to the soft disabled control may clear the condition. If cycling power does not clear the soft disable state then replace control. Clears automatically after successfully update.</p>
65544		Critical	HD Display (Thermostat)	Too many siblings	<p>The system is limited to no more than five (5) smart hubs assigned to one group. You can have up to nine groups (1-9) with five smart hubs assigned to each. If you have more than 5 smart hubs assigned to a single group, then alert code 65544 will be displayed. This alert code notification will only appear once. Once the system detects that only five or less smart hubs are detected in one group will the alert code automatically clears.</p>
65545		Moderate (On/Off) Default	HD Display (Thermostat)	Cooling Capacity Alert	<p>Cooling operation may not be sufficient for the hottest days. Based on local conditions and climatological data for zip code. Examples: Dirty Filter, Low Freon charge, TXV, etc. Symptom during mild temperatures may include; system running longer than normal but not showing any other symptoms. Auto cleared on next prediction.</p>

## Installation Checklist

<b>Smart Hub Checks:</b>		<b>YES</b>	<b>NO</b>
<b>1</b>	Is the smart hub properly mounted to either a wall stud or wall? (Do not mount on equipment or ductwork)		
<b>2</b>	Is communication status LED (green) visible? When LED is active it indicates that 24VAC is present at the smart hub. It also indicates communication is active between smart hub and HD Display.		
<b>3</b>	Are all terminal wiring properly connected and tight?		
<b>4</b>	When required, is either or both the discharge (DATS) and outdoor air temperature (OATS) sensors properly connected and isolated when used?		
<b>HD Display Checks:</b>		<b>YES</b>	<b>NO</b>
<b>1</b>	Is the HD Display properly placed and connected to subbase?		
<b>2</b>	Are all terminal wiring properly connected and tight on subbase?		
<b>3</b>	Is the screen blank after initial power-up? The HD Display may take up to three minutes before anything appears on the screen due to a HD Display low battery condition. HD Display battery charging only occurs when connected to the subbase.		
<b>System Checks</b>		<b>YES</b>	<b>NO</b>
<b>1</b>	Is the Wi-Fi connected?		
<b>2</b>	Can the homeowner access the consumer portal ( <a href="http://www.myicomfort.com">www.myicomfort.com</a> ) from either a PC or tablet?		
<b>3</b>	Has the homeowner downloaded the Lennox Thermostat application from either Google Play or IOS App Store to their mobile devices?		
<b>4</b>	Is the Lennox Dealer account number or your main shop phone number been added to the dealer information screen?		
<b>5</b>	If applicable, has the air handler's electric heat strips been commissioned? If not, commissioning of heat strips must be performed.		
<b>6</b>	Has a complete system test been run? If not, from the HD Display home screen go to <b>settings &gt; advance settings &gt; view dealer control center &gt; and select tests.</b>		

## Technical Support and Mobile App for Installers/Technicians Only

### Technical Support for Installers/Technicians Only

---

Lennox Residential technical support can be reached at 1-800-453-6669. Hours for support are Monday through Friday 8am - 8pm EST.

Get targeted help: Tell us the issue so we get you to right rep, offer relevant tips, reminders & follow-up!

- Complaints
- Technical support
- Repairs
- Returns

### iComfort Mobile Setup Application for Installers/Technicians Only

---

The Lennox iComfort Mobile Setup App lets HVAC technician's setup, configure and test a Lennox iComfort S30 system directly on their mobile device.

Once installed, the dealer can pair their mobile device to the Lennox iComfort smart hub to easily make changes from anywhere in the home, saving them the hassle of walking back and forth from the thermostat to the indoor and outdoor HVAC unit.

With just a touch, technicians can:

- Setup and Configure the system
- Adjust parameters
- Run system tests

This app is designed for Lennox HVAC technicians servicing iComfort E30 and S30 systems.

### LennoxPros Mobile Application for Installers/Technicians Only

---

LennoxPROs.com and the LennoxPROs mobile application have all the information HVAC Professionals and businesses need in one place. From shopping for parts and supplies to using our FREE e-tools, we have you covered.

## LennoxPros Dealer Dashboard

The dealer dashboard displays Dealer's iComfort® thermostat installations in one convenient location. It is accessible through the Service Dashboard at [www.LennoxPros.com](http://www.LennoxPros.com).

The thermostat can be accessible via the Dealer Dashboard only after the dealership's main phone number or company name is added during thermostat commissioning.

### Service Dashboard Search Screen

---

- Customers can be searched using the following criteria: first name, last name, first and last name, zip code, city, email address, equipment type, error code, serial number or model number.
- Customer searches can be filtered by various options: thermostat type, alert type, access level or maintenance reminders.

### Customer Results Screen

---

Displays a list of customers with installed iComfort® thermostats, and their locations:

- Name
- Address
- Phone
- Email
- Thermostat Type and Monitor Status

Map displays the following:

- Shows all customer's locations and any current alerts
- Color-coded pins on the map denote the following:
  - » Red - Critical Alert
  - » Yellow - Moderate Alert
  - » Green - No Alerts, normal operation
  - » Black - No system information sharing

**NOTE:** Click on a customer's pin to view information about their system.

**NOTE:** Selecting a customer from the list or map pin displays the detailed System Overview Screen including owner information, system components, system history, status and any alerts.

### Customer Details Screen

---

#### Home Systems

- Shows thermostat connection status
- Multiple home systems are displayed for each customer if there are more than one system.

## System History

This section provides a list of alerts over the past 12 months

### Remote In Button

- Allows dealer remote control of customer's thermostat (if enabled)
- Remote In thermostat controls have the same appearance and functions as the touchscreen display, making it easy to make any settings and adjustments.
- Button is red if access is granted by homeowner and gray if Remote In is disabled at the thermostat.

### Alerts & Reminders: System

Tabs for Alerts - Critical, Moderate, Cleared and Reminders

**NOTE:** Clicking on a card with an alert expands to display the Remote In control (if enabled by the homeowner) and Troubleshoot (access to the Lennox Troubleshooting Center which includes error code lookups and any available documentation).

### Equipment & Reports

- Equipment Tab
  - » A detailed list of all installed equipment for a particular system
  - » Menus are available for each Equipment Type for Technical Documents, Warranty Lookup and Repair Parts.
- Reports Tab
  - » View Performance Reports, Installation Reports and Installation Update Reports
  - » Generate Monthly Performance Reports
  - » Generate Installation Update reports
  - » View Performance Reports Button displays a graphical view of the system performance
  - » Generating any report will save it as a PDF file to send to the customer or for record keeping.

**NOTE:** For additional information please visit the Service Tools Help Center and click on Service Dashboard.

## Summary of Changes

Instruction Date	Firmware or Hardware Change	Summary of Changes
5/2020	3.65.xxxx	Corrections of descriptions for various alarms. Added of California Title 24, Demand Response added. Updates to reports. Installing using the new smart hub 3.0 along with the HD Display 3.0. Screw terminals are now used and the order of the terminals have changed.







# Index

## A

- Advanced Dehumidification
  - Descriptions 44
- Airflow Profile - Cooling 38, 39
- Alert Codes and Troubleshooting 55
- Apple HomeKit 19
- Auto Brightness 40
- Auto Changeover
  - Humidif. Deadband 23
  - Temp Deadband 23
- Auto Dehumidification
  - Overcooling Threshold 23
- Automatic Max Defrost 35
- Aux Heating Activation Threshold 23

## B

- Balance Point Control 23
- Boot-up Screen 19
- Brightness Value 40

## C

- Commissioning
  - Using the HD Display 19
  - Using the Mobile Setup App 17
- Compressor Shift Delay ON / OFF 35, 36
- Compressor Short Cycle Delay 35, 37
- Continuous Indoor Blower Airflow 38, 39
- Cooling Indoor Blower
  - Off Delay 38, 39
  - On Delay 38, 39
- Cooling Mode 24

## Cooling Prognostics 24

## D

- Dealer Control Center 22
- Defrost Termination Temp 36
- Dehumidification
  - Airflow % 39
  - Airflow Adjustment Adder 36, 37
  - Set Point 43
  - Setting Options 43
- Dew Point Adjustment 24
- Diagnostics 42
- Dimensions 3
- Discharge Air Sensor (DATS) 6
  - Integral Gain 24
  - Offset 24
  - Proportional Gain 24
- Display
  - Air Quality 40
  - Indoor Humidity 40
  - Outdoor Weather 40

## E

- Electrical
  - Specifications 3
- Electric Heat
  - Airflow 38
  - Control Mode 24
  - Stages During Defrost 25
- Energy Recovery Ventilator (ERV) 46
- Equipment Name
  - Air Conditioner 37
  - Air Handler 38
  - Furnace 39
  - Heat Pump 36
  - Smart Hub 25
  - Zoning Control 40

## EvenHeat Discharge Temp 25

## F

- Factory Reset
  - Smart Hub 42
  - Thermostat 42
- Fan Cycling 36
- Freezing Alert Temperature 28
- Fresh Air Damper 20
- Fresh Air Dampers 45

## G

- Gas Heat Control Mode (SLP98 only) 25
- Gas Heating Activation Temp Difference 25
- Group ID 25

## H

- Heat / Cool Stages Locked In 25, 34
- Heating Airflow Control Type 39
- Heating Indoor Blower
  - Off Delay 38, 39
  - On Delay 38, 39
- Heat Recovery Ventilator (HRV) 46
- High
  - Balance Point 23
  - Cooling Airflow 38, 39
  - Heating Airflow 39
  - HP Airflow 38, 40
  - Normal Cooling Airflow 36, 37
  - Normal HP Heating Airflow 36

## HP

- Blower On Delay 40
- Heating Lockout Time 25
- Heating Mode 26
- Indoor Blower Off Delay 38, 40

*Indoor Blower On Delay 38*

- Humiditrol Comfort Adjust 26
- Humidity Reading Calibration 26

## I

- iHarmony Zoning 20, 45
- Information 43
- Installation
  - Checklist 94
  - Recommendations 14
  - Report 42

## L

- Language Selection 19
- Lock In 2nd Stage HP by Outdoor Temp 26

## Low

- Balance Point 24
- Cooling Airflow 38, 40
- Heating Airflow 40
- HP Airflow 38
- Normal Cooling Airflow 36, 37
- Normal HP Heating Airflow 37

## M

- Max
  - Defrost by Weather 37
  - Heat Setpoint 26
  - Humidification Setpoint 26

## Min

- Cool Setpoint 26
- Dehumidification Setpoint 26

## Mobile Applications 95

## Modulating

- Cooling Cycles Per Hour 26
- Cooling Steady State PI Gain 27
- Cooling Step Change PI Gain 27
- Gas Heating Cycles Per Hour (SLP98V only) 27

*Gas Heating Steady State PI Gain (SLP98V only) 27*  
*Gas Heating Step Change PI Gain (SLP98V only) 27*  
*HP Heating Cycles Per Hour 27*  
*HP Heating Steady State PI Gain 27*  
*HP Heating Step Change PI Gain 27*

## **N**

**Number of Gas Heating Stages 28**

## **O**

**Operating Environment 3**

**Outdoor Air Sensor 6**

**Outdoor Temperature**

*Calibration 28*

*Reading Calibration 23*

*Source 41*

**Overcooling 43**

## **P**

**Perfect Temp 28**

**Proximity Control 41**

**PureAir S 45**

**PureAir Wiring Diagram 13**

## **R**

**Received Signal Strength Indication (RSSI) 52**

**Re-configure System 42**

**Remote In 17, 18**

**Reset**

*Air Conditioner 37*

*Air Handler 38*

*Furnace 40*

*Heat Pump 37*

*HVAC Equipment 42*

*Smart Hub 28*

*Thermostat 41*

*Zoning Control 40*

## **S**

**Screen Locked 41**

**Screen Saver 41**

**Smart Alert Enable 29**

**Smart Hub**

*Group ID 25*

*Installation 3*

*LEDs 4*

*Multiple Devices 18, 25*

*Parameters 23*

*Push Button 4*

*Restart 18, 42*

*Terminals 4*

**Smooth Setback Recovery (SSR) 29**

**Soft Disable 55**

**Stage**

*Delay Timers 29, 30*

*Differentials 30*

**Subbase Installation 15**

## **T**

**Temperature Control Mode 30, 32**

**Temperature Unit Selection 20**

**Temp Reading Calibration 30**

**Tests 42**

**Troubleshooting Wi-Fi Connection 52**

## **V**

**Ventilation**

*Control Mode 46*

*Control Mode Parameters 30*

*Control Wiring 13*

*Filter 20*

*Maintenance 20*

*Reminders 20*

## **W**

**Wall Insulation 32**

**Wide Setpoint 41**

**Wi-Fi 51**

*Accessory Configuration (WAC) 19*

*Access Point Hidden 52*

*Setting Up Connection 51*

*Signal Strength Indicator 52*

*Troubleshooting 52*

*Visible Access Point 52*

## **Z**

**Zone 1 through 4**

*Continuous Blower CFM 32*

*Cooling CFM 32*

*Heating CFM 32*

*Temp Reading Calibration 40*

**Zoning**

*Anticipated Discharge Air Temperature Adjustment 33*

*Continuous Blower CFM 32*

*Gas Heating DAT Cool Down Target 33*

*Minimum Zone Run-Time 33*

*Supply Air Temp Limit for Cooling 33*

*Supply Air Temp Limit for Gas / Electric Heating 33*

*Target Supply Air Temp for Cooling 33*

*Target Supply Air Temp for HP Heating 33*

**Zoning Target Supply Air Temp for Gas/Electric Heating 33**