



© 2022 Lennox Industries Inc.  
Dallas, Texas USA



# INSTALLATION INSTRUCTIONS EL280DFE

ELITE® SERIES GAS FURNACE  
DOWNFLOW AIR DISCHARGE

507910-02  
07/2022  
Supersedes 04/2022

**THIS MANUAL MUST BE LEFT WITH THE  
HOMEOWNER FOR FUTURE REFERENCE**

**!** This is a safety alert symbol and should never be ignored. When you see this symbol on labels or in manuals, be alert to the potential for personal injury or death.

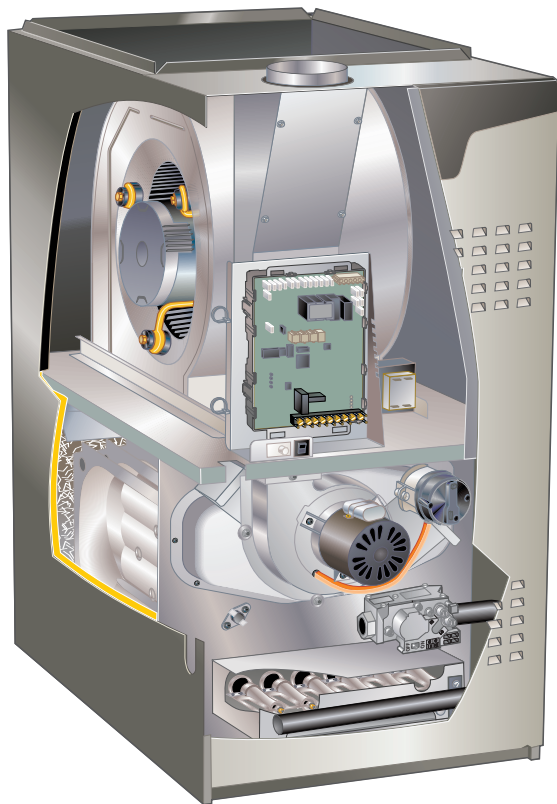

## **!** WARNING

Improper installation, adjustment, alteration, service or maintenance can cause property damage, personal injury or loss of life. Installation and service must be performed by a licensed professional HVAC installer (or equivalent), service agency or the gas supplier.

## **!** CAUTION

As with any mechanical equipment, contact with sharp sheet metal edges can result in personal injury. Take care while handling this equipment and wear gloves and protective clothing.

### Contents

Unit Dimensions - inches (mm) .....	2	Gas Piping .....	17
EL280DFE Gas Furnace .....	3	Electrical .....	19
Shipping and Packing List .....	3	Integrated Control .....	26
Safety .....	3	Unit Start-Up .....	30
Use of Furnace as a Construction Heater .....	4	Gas Pressure Measurement .....	32
General .....	4	Proper Combustion .....	32
Combustion, Dilution, Ventilation Air .....	5	High Altitude .....	32
Down Flow Installation .....	8	Other Unit Adjustments .....	33
Setting Equipment .....	9	Sequence of Operation .....	33
Filters .....	10	Service .....	34
Duct System .....	11	Start-Up and Performance Checklist .....	38
Venting .....	11	Blower Data .....	40



**Unit Dimensions - inches (mm)**

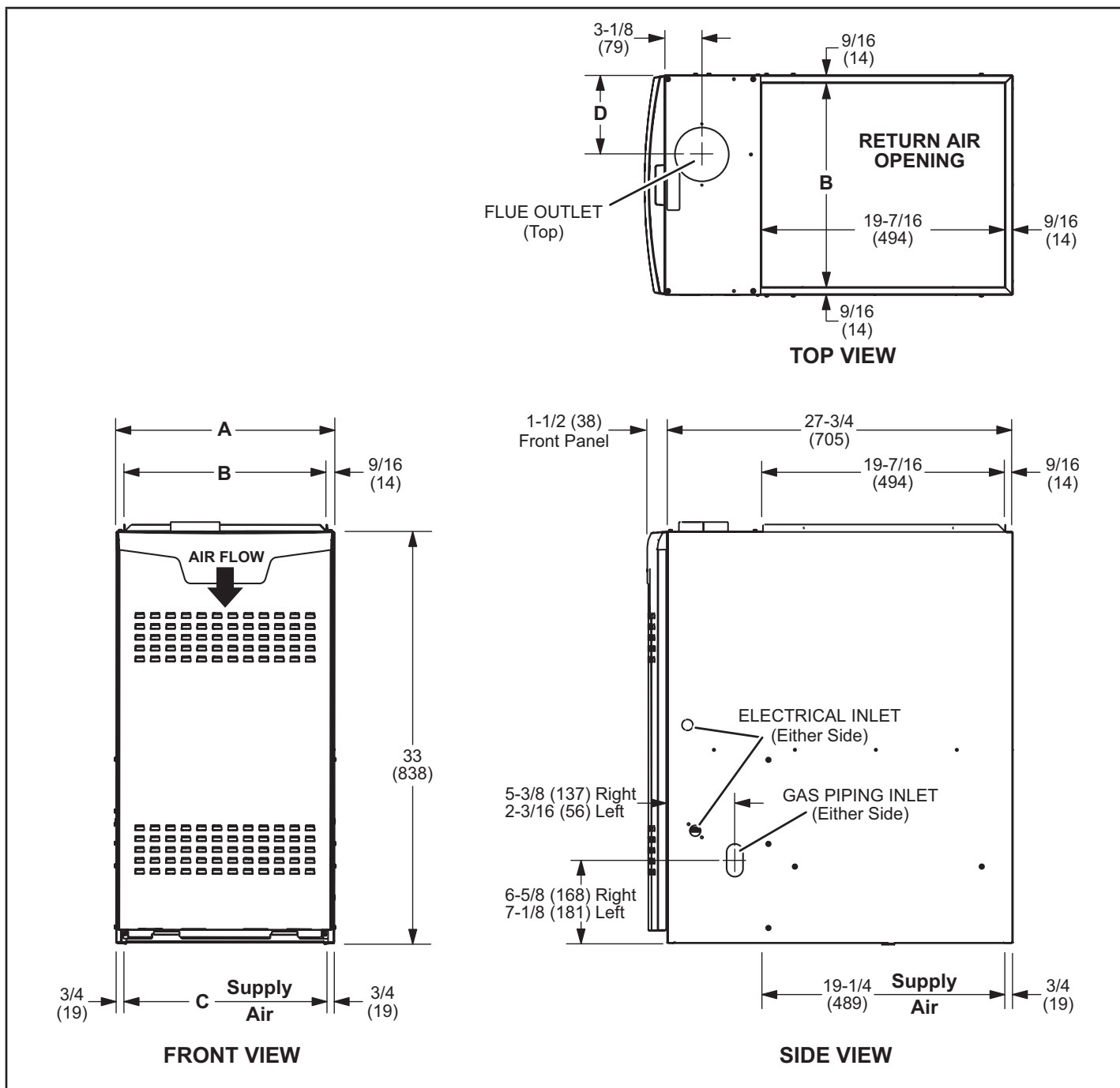

Model No.	A		B		C		D	
	in	mm	in	mm	in	mm	in	mm
EL280DF070E36A	14-1/2	368	13-3/8	340	13	330	4-3/4	121
EL280DF090E48B	17-1/2	446	16-3/8	416	16	406	6-1/4	159

## EL280DFE Gas Furnace

The EL280DFE gas furnace is shipped ready for installation in the downflow position fueled by natural gas. A conversion kit (ordered separately) is required for use in LP/ Propane gas applications.

## Shipping and Packing List

### Package 1 of 1 contains

- 1 - Assembled EL280DFE unit
- 1 - Bag assembly containing the following:
  - 2 - Screws
  - 1 - Snap bushing
  - 1 - Snap plug
  - 1 - Wire tie
  - 1 -Vent warning label
  - 1 - Owner's manual and warranty card

The following items may be ordered separately:

- 1 - Thermostat
- 1 - LP/Propane changeover kit
- 1 - Combustible flooring base
- 1 - High altitude kit

Check equipment for shipping damage. If you find any damage, immediately contact the last carrier.

## Safety

### DANGER

#### Danger of explosion.

There are circumstances in which odorant used with LP/propane gas can lose its scent. In case of a leak, LP/propane gas will settle close to the floor and may be difficult to smell. An LP/propane leak detector should be installed in all LP applications.

### WARNING

Improper installation, adjustment, alteration, service or maintenance can cause property damage, personal injury or loss of life. Installation and service must be performed by a licensed professional installer (or equivalent), service agency or the gas supplier.

### CAUTION

As with any mechanical equipment, contact with sharp sheet metal edges can result in personal injury. Take care while handling this equipment and wear gloves and protective clothing.

## Certifications

EL280DFE units are CSA International certified.

In the USA, installation of gas furnaces must conform with local building codes. In the absence of local codes, units must be installed according to the current National Fuel Gas Code (ANSI-Z223.1). The National Fuel Gas Code is available from the following address:

American National Standards Institute, Inc.  
11 West 42nd Street  
New York, NY 10036

## Clearances

Adequate clearance must be made around the air openings into the vestibule area. In order to ensure proper unit operation, combustion and ventilation air supply must be provided according to the current National Fuel Gas Code. Vent installations must be consistent with the National Fuel

Gas Code venting tables (in this instruction) and applicable provisions of local building codes.

This furnace is CSA International certified for installation clearances to combustible material as listed on the unit nameplate and in the tables in figure 13. Accessibility and service clearances must take precedence over fire protection clearances.

## Installed Locations

For installation in a residential garage, the furnace must be installed so that the burner(s) and the ignition source are located no less than 18 inches (457 mm) above the floor. The furnace must be located or protected to avoid physical damage by vehicles. When a furnace is installed in a public garage, hangar, or other building that has a hazardous atmosphere, the furnace must be installed according to recommended good practice requirements and current National Fuel Gas Code.

**NOTE** - Furnace must be adjusted to obtain a temperature rise within the range(s) specified on the unit nameplate. Failure to do so may cause erratic limit operation and may also result in premature heat exchanger failure.

This EL280DFE furnace must be installed so that its electrical components are protected from water.

## Installed in Combination with a Cooling Coil

When this furnace is used with cooling units, it shall be installed in parallel with, or on the upstream side of, cooling units to avoid condensation in the heating compartment.

With a parallel flow arrangement, a damper (or other means to control the flow of air) must adequately prevent chilled air from entering the furnace (see FIGURE 1). If the damper is manually operated, it must be equipped to prevent operation of either the heating or the cooling unit, unless it is in the full **HEAT** or **COOL** setting.

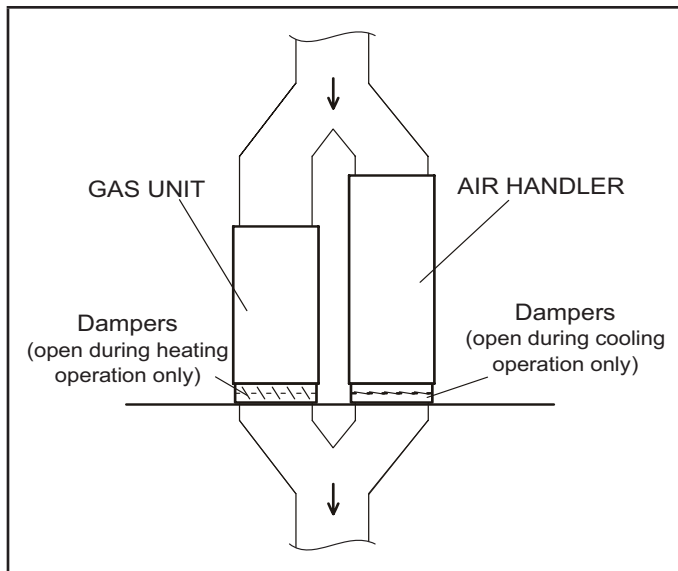

**FIGURE 1**

When installed, this furnace must be electrically grounded according to local codes. In addition, in the United States, installation must conform with the current National Electric Code, ANSI/NFPA No. 70. The National Electric Code (ANSI/NFPA No. 70) is available from the following address:

National Fire Protection Association  
1 Battery March Park  
Quincy, MA 02269

**NOTE** - This furnace is designed for a minimum continuous return air temperature of 60°F (16°C) or an intermittent operation down to 55°F (13°C) dry bulb for cases where a night setback thermostat is used. Return air temperature must not exceed 85°F (29°C) dry bulb.

The EL280DFE furnace may be installed in alcoves, closets, attics, basements, garages, and utility rooms in the downflow position.

**This furnace design has not been CSA International certified for installation in mobile homes, recreational vehicles, or outdoors.**

### Safety

Lennox does not recommend the use of EL280DFE units as a construction heater during any phase of construction. Very low return air temperatures, harmful vapors and operation of the unit with clogged or misplaced filters will damage the unit.

EL280DFE units may be used for heating of buildings or structures under construction, if the following conditions are met:

- The vent system must be permanently installed per these installation instructions.
- A room thermostat must control the furnace. The use of fixed jumpers that will provide continuous heating is not allowed.
- The return air duct must be provided and sealed to the furnace.

- Return air temperature range between 60°F (16°C) and 80°F (27°C) must be maintained.
- Air filters must be installed in the system and must be maintained during construction.
- Air filters must be replaced upon construction completion.
- The input rate and temperature rise must be set per the furnace rating plate.
- One hundred percent (100%) outdoor air must be provided for combustion air requirements during construction. Temporary ducting may supply outdoor air to the furnace. Do not connect duct directly to the furnace. Size the temporary duct following these instructions in section for Combustion, Dilution and Ventilation Air in a confined space with air from outside.
- The furnace heat exchanger, components, duct system, air filters and evaporator coils must be thoroughly cleaned following final construction clean-up.
- All furnace operating conditions (including ignition, input rate, temperature rise and venting) must be verified according to these installation instructions

### General

These instructions are intended as a general guide and do not supersede local codes in any way. Consult authorities having jurisdiction before installation.

In addition to the requirements outlined previously, the following general recommendations must be considered when installing a EL280DFE furnace:

- Place the furnace as close to the center of the air distribution system as possible. The furnace should also be located close to the chimney or vent termination point.
- Do not install the furnace where drafts might blow directly into it. This could cause improper combustion and unsafe operation.
- Do not block the furnace combustion air openings with clothing, boxes, doors, etc. Air is needed for proper combustion and safe unit operation.
- When the furnace is installed in an attic or other insulated space, keep insulation away from the furnace.

**NOTE** - The Commonwealth of Massachusetts stipulates these additional requirements:

- Gas furnaces shall be installed by a licensed plumber or fitter only.
- The gas cock must be "T handle" type.
- When a furnace is installed in an attic, the passageway to and service area surrounding the equipment shall be floored.

## Combustion, Dilution & Ventilation Air

In the past, there was no problem in bringing in sufficient outdoor air for combustion. Infiltration provided all the air that was needed. In today's homes, tight construction practices make it necessary to bring in air from outside for combustion.

Take into account that exhaust fans, appliance vents, chimneys, and fireplaces force additional air that could be used for combustion out of the house. Unless outside air is brought into the house for combustion, negative pressure (outside pressure is greater than inside pressure) will build to the point that a downdraft can occur in the furnace vent pipe or chimney. As a result, combustion gases enter the living space creating a potentially dangerous situation.

In the absence of local codes concerning air for combustion and ventilation, use the guidelines and procedures in this section to install EL280DFE furnaces to ensure efficient and safe operation. You must consider combustion air needs and requirements for exhaust vents. A portion of this information has been reprinted with permission from the National Fuel Gas Code (ANSI-Z223.1). This reprinted material is not the complete and official position of the ANSI on the referenced subject, which is represented only by the standard in its entirety.

## CAUTION

Do not install the furnace in a corrosive or contaminated atmosphere. Meet all combustion and ventilation air requirements, as well as all local codes.

All gas-fired appliances require air for the combustion process. If sufficient combustion air is not available, the furnace or other appliances will operate inefficiently and unsafely. Enough air must be provided to meet the needs of all fuel-burning appliances and appliances such as exhaust fans which force air out of the house. When fireplaces, exhaust fans, or clothes dryers are used at the same time as the furnace, much more air is necessary to ensure proper combustion and to prevent a downdraft. Insufficient air causes incomplete combustion which can result in carbon monoxide.

In addition to providing combustion air, fresh outdoor air dilutes contaminants in the indoor air. These contaminants may include bleaches, adhesives, detergents, solvents and other contaminants which can corrode furnace components.

## CAUTION

Insufficient combustion air can cause headaches, nausea, dizziness or asphyxiation. It will also cause excess water in the heat exchanger resulting in rusting and premature heat exchanger failure. Excessive exposure to contaminated combustion air will result in safety and performance related problems. Avoid exposure to the following substances in the combustion air supply:

**Permanent wave solutions**

**Chlorinated waxes and cleaners**

**Chlorine base swimming pool chemicals**

**Water softening chemicals**

**De-icing salts or chemicals**

**Carbon tetrachloride**

**Halogen type refrigerants**

**Cleaning solvents (such as perchloroethylene)**

**Printing inks, paint removers, varnishes, etc.**

**Hydrochloric acid**

**Cements and glues**

**Antistatic fabric softeners for clothes dryers**

**Masonry acid washing materials**

The requirements for providing air for combustion and ventilation depend largely on whether the furnace is installed in an unconfined or a confined space.

### Unconfined Space

An unconfined space is an area such as a basement or large equipment room with a volume greater than 50 cubic feet (1.42 m<sup>3</sup>) per 1,000 Btu (.29 kW) per hour of the combined input rating of all appliances installed in that space.

This space also includes adjacent rooms which are not separated by a door. Though an area may appear to be unconfined, it might be necessary to bring in outdoor air for combustion if the structure does not provide enough air by infiltration. If the furnace is located in a building of tight construction with weather stripping and caulking around the windows and doors, follow the procedures in the air from outside section.

### Confined Space

A confined space is an area with a volume less than 50 cubic feet (1.42 m<sup>3</sup>) per 1,000 Btu (.29 kW) per hour of the combined input rating of all appliances installed in that space. This definition includes furnace closets or small equipment rooms.



When the furnace is installed so that supply ducts carry air circulated by the furnace to areas outside the space containing the furnace, the return air must be handled by ducts which are sealed to the furnace casing and which terminate outside the space containing the furnace. This is especially important when the furnace is mounted on a platform in a confined space such as a closet or small equipment room. Even a small leak around the base of the unit at the platform or at the return air duct connection can cause a potentially dangerous negative pressure condition. Air for combustion and ventilation can be brought into the confined space either from inside the building or from outside.

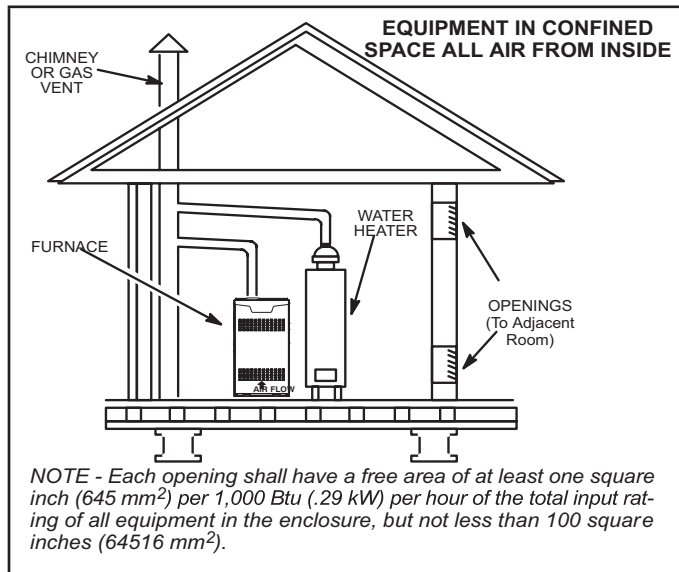

**FIGURE 2**

**Air from Inside**

If the confined space that houses the furnace adjoins a space categorized as unconfined, air can be brought in by providing two permanent openings between the two spaces. Each opening must have a minimum free area of 1 square inch (645 mm<sup>2</sup>) per 1,000 Btu (.29 kW) per hour of total input rating of all gas-fired equipment in the confined space.

Each opening must be at least 100 square inches (64516 mm<sup>2</sup>). One opening shall be within 12 inches (305 mm) of the top of the enclosure and one opening within 12 inches (305 mm) of the bottom. See FIGURE 2.

**Air from Outside**

If air from outside is brought in for combustion and ventilation, the confined space must have two permanent openings. One opening shall be within 12 inches (305 mm) of the top of the enclosure and one opening within 12 inches (305 mm) of the bottom. These openings must communicate directly or by ducts with the outdoors or spaces (crawl or attic) that freely communicate with the outdoors or indirectly through vertical ducts. Each opening shall have a minimum free area of 1 square inch (645 mm<sup>2</sup>) per 4,000 Btu (1.17 kW) per hour of total input rating of all equipment in the enclosure. See FIGURE 3 and FIGURE 4. When communicating with the outdoors through horizontal ducts, each opening shall have a minimum free area of 1 square inch (645 mm<sup>2</sup>) per 2,000 Btu (.56 kW) per total input rating of all equipment in the enclosure. See FIGURE 5.

When ducts are used, they shall be of the same cross-sectional area as the free area of the openings to which they connect. The minimum dimension of rectangular air ducts shall be no less than 3 inches (75 mm). In calculating free area, the blocking effect of louvers, grilles, or screens must be considered. If the design and free area of protective covering is not known for calculating the size opening required, it may be assumed that wood louvers will have 20 to 25 percent free area and metal louvers and grilles will have 60 to 75 percent free area. Louvers and grilles must be fixed in the open position or interlocked with the equipment so that they are opened automatically during equipment operation.

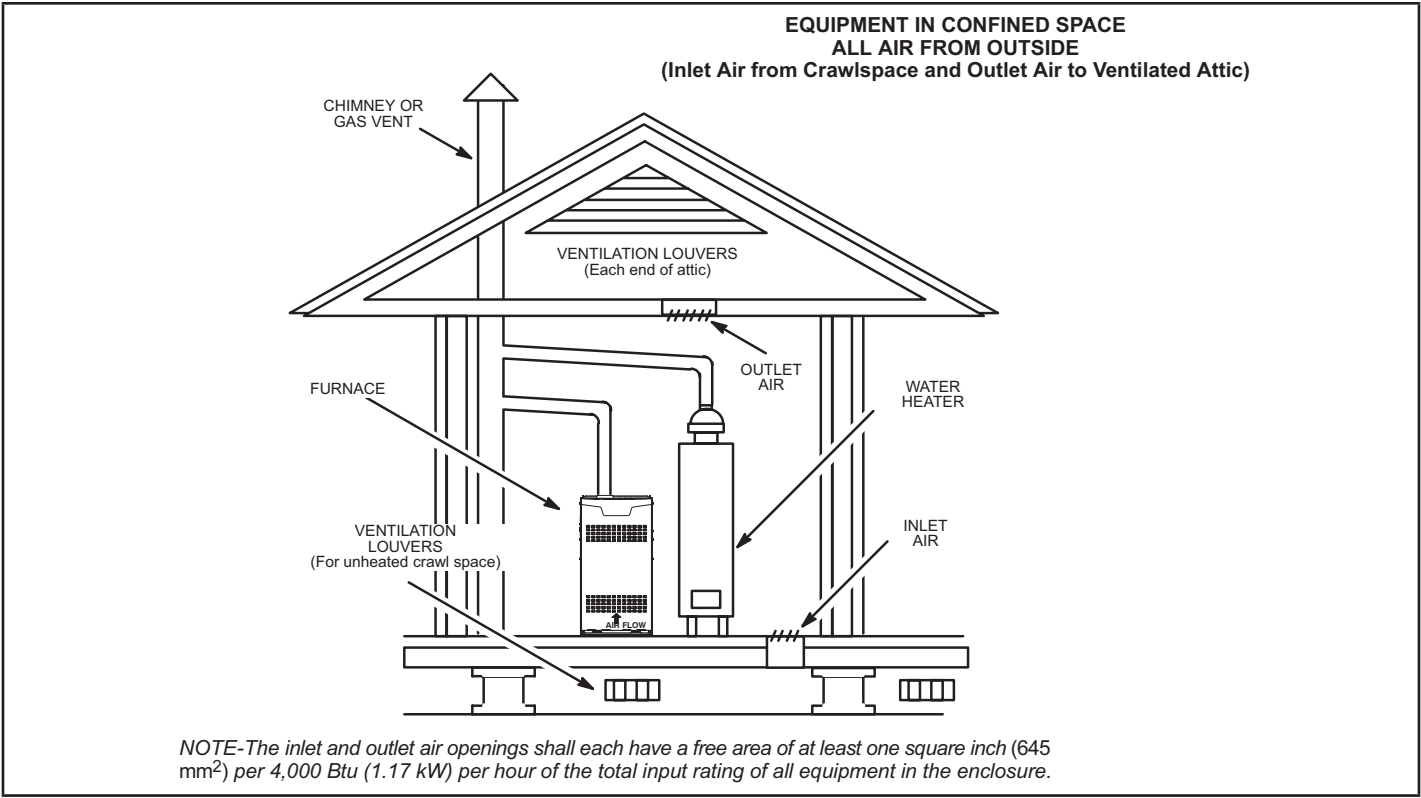

**FIGURE 3**

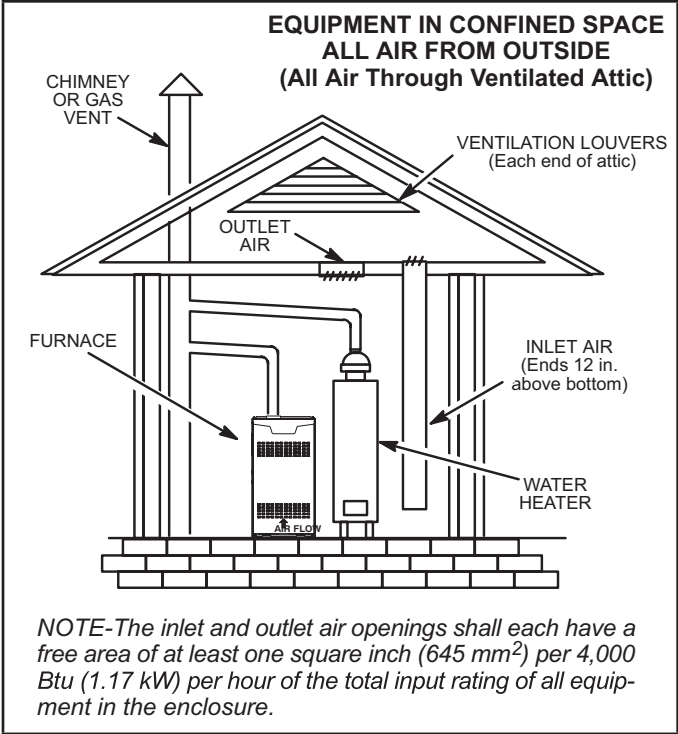

**FIGURE 4**

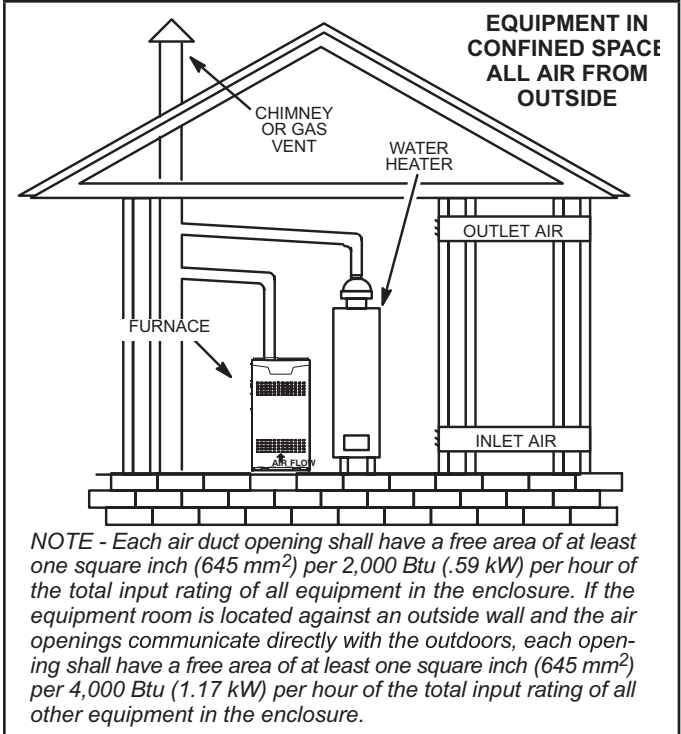

**FIGURE 5**

## Downflow Installation

Downflow unit installs in three ways: on non-combustible flooring, on combustible flooring using a downflow combustible flooring base, or on a reverse-flow cooling cabinet. Do not drag the unit across the floor.

### Installation on Non-Combustible Flooring (FIGURE 6)

- 1 - Cut floor opening keeping in mind clearances listed on unit rating plate. Also keep in mind gas supply connections, electrical supply, flue and air intake connections and sufficient installation and servicing clearances. See TABLE 1 for correct floor opening size.
- 2 - Flange warm air plenum and lower the plenum into the opening.
- 3 - Set the unit over the plenum and seal the plenum to the unit.
- 4 - Ensure that the seal is adequate.

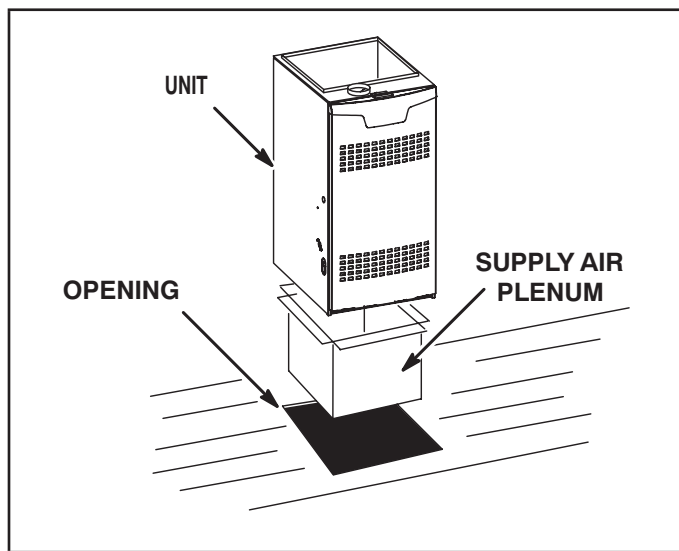

FIGURE 6

TABLE 1  
NON-COMBUSTIBLE FLOOR OPENING SIZE

Cabinet Width	Front to Rear		Side to Side	
	in	mm	in	mm
A (14.5")	19-3/4	502	13-1/4	337
B (17.5")	19-3/4	502	16-1/4	413

NOTE - Floor opening dimensions listed are 1/4 inch (6 mm) larger than the unit opening. See unit dimensions on page 2.

### Installation on Combustible Flooring (FIGURE 7)

- 1 - When unit is installed on a combustible floor, a downflow combustible flooring base must be installed between the furnace and the floor. The base must be ordered separately.

See TABLE 2 for opening size to cut in floor.

## ! IMPORTANT

The furnace and downflow combustible flooring base shall not be installed directly on carpeting, tile, or other combustible material other than wood flooring.

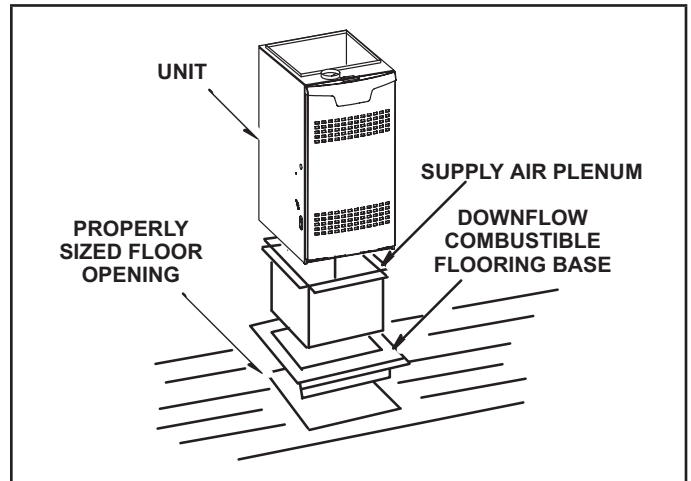

FIGURE 7

TABLE 2  
COMBUSTIBLE FLOOR OPENING SIZE

Cabinet Width	Front to Rear		Side to Side	
	in	mm	in	mm
A (14.5")	22	559	15-3/4	400
B (17.5")	22	559	18-3/4	476

- 2 - After opening is cut, set combustible flooring base into opening.

- 3 - Check sealing strips on combustible flooring base to make sure they are properly glued and positioned.

- 4 - Lower supply air plenum into downflow combustible flooring base until plenum flanges seal against the strips.

**NOTE** - Be careful not to damage sealing strips. Check for a tight seal.

- 5 - Set the furnace over the plenum.

- 6 - Ensure that the seal between the furnace and plenum is adequate.

### Installation on Cooling Cabinet (FIGURE 8)

- 1 - Refer to reverse-flow coil installation instructions for correctly sized opening in floor and installation of cabinet.

**NOTE** - Downflow combustible flooring kit is not used.

- 2 - When cooling cabinet is in place, set and secure the furnace according to the instructions that are provided with the cooling coil. Secure the furnace to the cabinet.

- 3 - Seal the cabinet and check for air leaks.



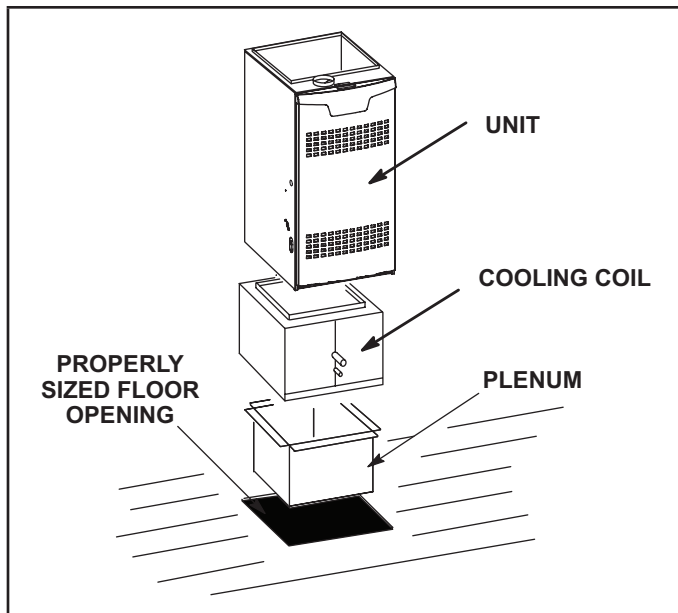
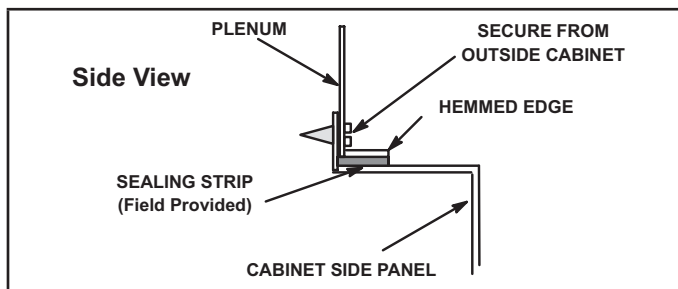

**FIGURE 8**

**Return Air Opening -- Downflow Units**

The following steps should be taken when installing plenum:

- 1 - Bottom edge of plenum should be flanged with a hemmed edge (See FIGURE 9).



**FIGURE 9**

- 2 - Sealing strip should be used.
- 3 - In all cases, plenum should be secured to top flanges of furnace with sheet metal screws.

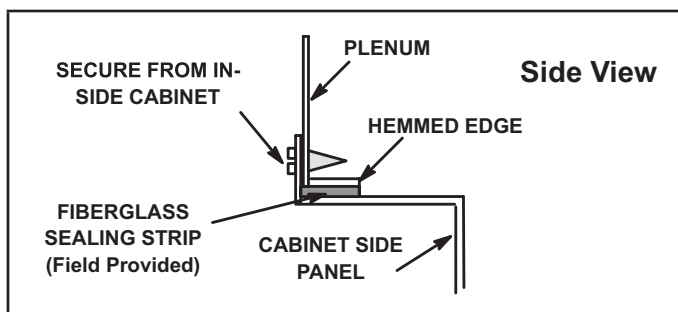

**FIGURE 10**

- 4 - In closet installations, it may be impossible to install sheet metal screws from the outside. In this case, make plenum with a removable front and install screws from the inside (See FIGURE 10).
- 5 - Make certain that an adequate seal is made.

**Setting Equipment**

**⚠ WARNING**

**Do not install the furnace on its front, back or in the horizontal position. See FIGURE 12. Do not connect the return air ducts to the back of the furnace. Doing so will adversely affect the operation of the safety control devices, which could result in personal injury or death.**

Install the EL280DFE gas furnace as shipped in the downflow position only. **Do not install the furnace horizontally.**

Select a location that allows for the required clearances that are listed on the unit nameplate. Also consider gas supply connections, electrical supply, vent connection, and installation and service clearances [24 inches (610 mm) at unit front]. The unit must be level.

Units with 1/2 and 3/4 hp blower motor are equipped with three flexible legs and one rigid leg. The rigid leg is equipped with a shipping bolt and a flat white plastic washer (rather than the rubber mounting grommet used with a flexible mounting leg). See FIGURE 11. **The bolt and washer must be removed before the furnace is placed into operation.** After the bolt and washer have been removed, the rigid leg will not touch the blower housing.

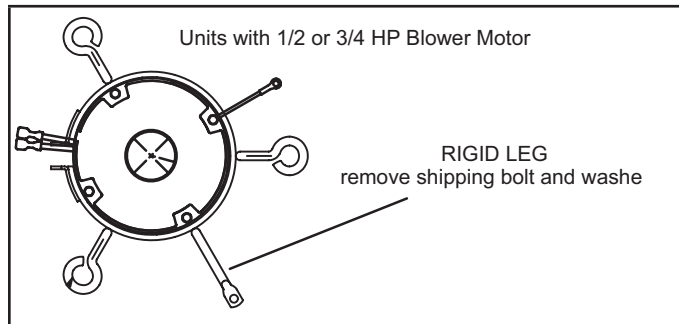

**FIGURE 11**

**⚠ WARNING**

**The blower access panel must be securely in place when the blower and burners are operating. Gas fumes, which could contain carbon monoxide, can be drawn into living space resulting in personal injury or death.**

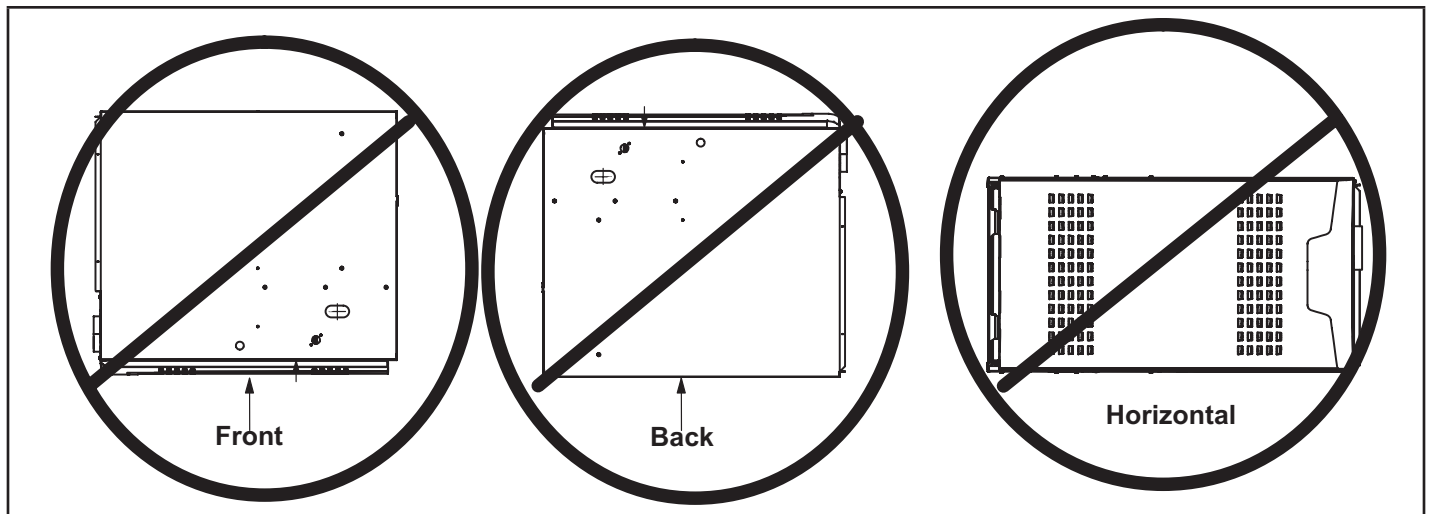

Figure 12

### Downflow Application

Allow for clearances to combustible materials as indicated on the unit nameplate. Minimum clearances for closet or alcove installations are shown in FIGURE 13.

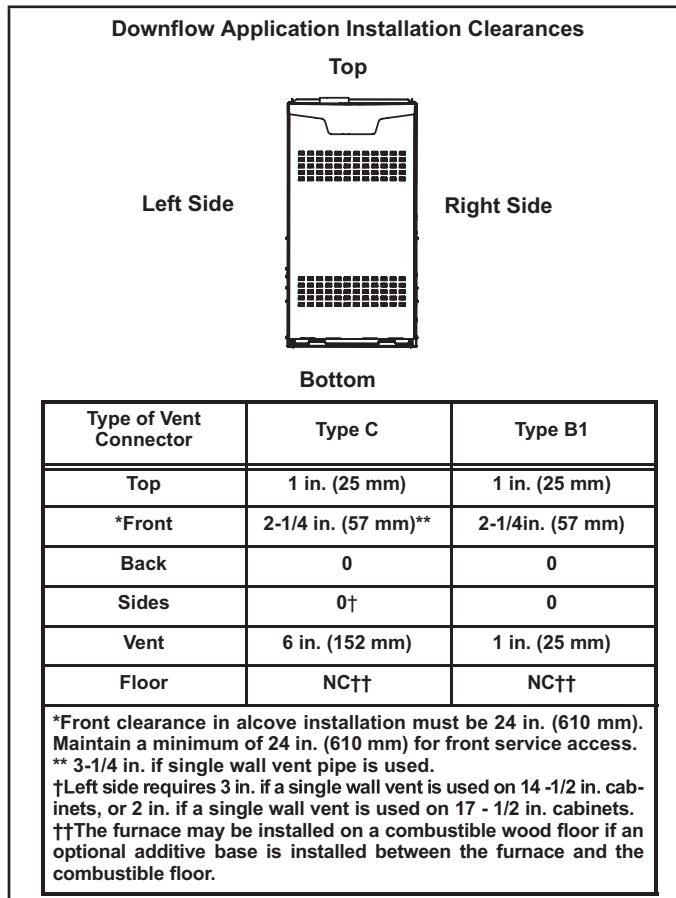

FIGURE 13

## ⚠ WARNING

**Improper installation of the furnace can result in personal injury or death. Combustion and flue products must never be allowed to enter the return air system or the living space. Use screws and joint tape to seal the return air system to the furnace.**

**In platform installations with bottom return air, the furnace should be sealed airtight to the return air plenum. A door must never be used as a portion of the return air duct system. The base must provide a stable support and an airtight seal to the furnace. Allow absolutely no sagging, cracks, gaps, etc. The return and supply air duct systems must never be connected to or from other heating devices such as a fireplace or stove, etc. Fire, explosion, carbon monoxide poisoning, personal injury and/or property damage could result.**

### Filters

This unit is not equipped with a filter or rack. A field-provided high-velocity filter is required for the unit to operate properly. TABLE 3 lists recommended filter sizes.

A filter must be in place any time the unit is operating.

**TABLE 3**

Cabinet Width	Return Air Filter Size (inches)
A (14-1/2")	14 x 25 x 1 (1)
B (17-1/2")	16 x 25 x 1 (1)

## Duct System

Use industry-approved standards (such as those published by Air Conditioning Contractors of America or American Society of Heating, Refrigerating and Air Conditioning Engineers) to size and install the supply and return air duct system. See FIGURE 14 for proper duct installation. This will result in a quiet and low-static system that has uniform air distribution.

**NOTE** - Do not operate the furnace in the heating mode with an external static pressure that exceeds 0.5 inches w.c. Higher external static pressures may cause erratic limit operation.

Ensure that you have made a seal between the supply air plenum and the furnace and between the furnace and the return air plenum.

## Return Air Plenum

**Return air must not be drawn from a room where this furnace, or any other gas-fueled appliance (i.e., water heater), or carbon monoxide-producing device (i.e., wood fireplace) is installed.** When return air is drawn from a room, a negative pressure is created in the room. If a gas appliance is operating in a room with negative pressure, the flue products can be pulled back down the vent pipe and into the room. This reverse flow of the flue gas may result in incomplete combustion and the formation of carbon monoxide gas. This toxic gas might then be distributed throughout the house by the furnace duct system.

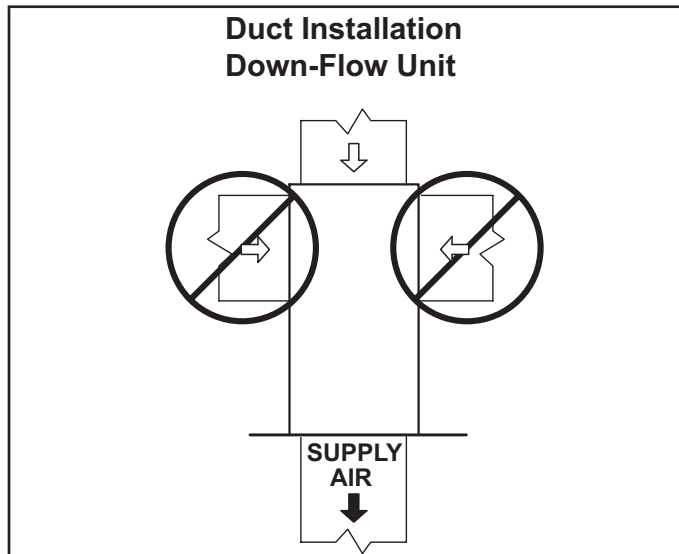

FIGURE 14

## Venting

A 4-inch diameter flue transition is factory-installed on all models. Modifying or removing the flue transition will cause the unit to operate unsafely and will void the unit certification. The vent connector does not require insulation.

The EL280DFE series units are classified as fan-assisted Category I furnaces when vertically vented according to the latest edition of National Fuel Gas Code (NFPA 54 / ANSI Z223.1). A fan-assisted Category I furnace is an appliance equipped with an integral mechanical means to either draw or force combustion products through the combustion chamber and/or heat exchanger.

**NOTE** - Use these instructions as a guide. They do not supersede local codes. This furnace must be vented according to all local codes, these installation instructions, and the provided venting tables in these instructions.

The venting tables in this manual were extracted from the National Fuel Gas Code (NFPA 54 / ANSI Z223.1) and are provided as a guide for proper vent installation. Proper application, termination, construction and location of vents must conform to local codes having jurisdiction. In the absence of local codes, the NFGC serves as the defining document.

Refer to the tables and the venting information contained in these instructions to properly size and install the venting system.

## IMPORTANT

Once the venting system is installed, attach the "Disconnected Vent" warning sticker to a visible area of the plenum near the vent pipe. The warning sticker is provided in the bag assembly. Order kit 66W04 for additional stickers.

## WARNING

Asphyxiation hazard. The exhaust vent for this furnace must be securely connected to the furnace flue transition at all times.

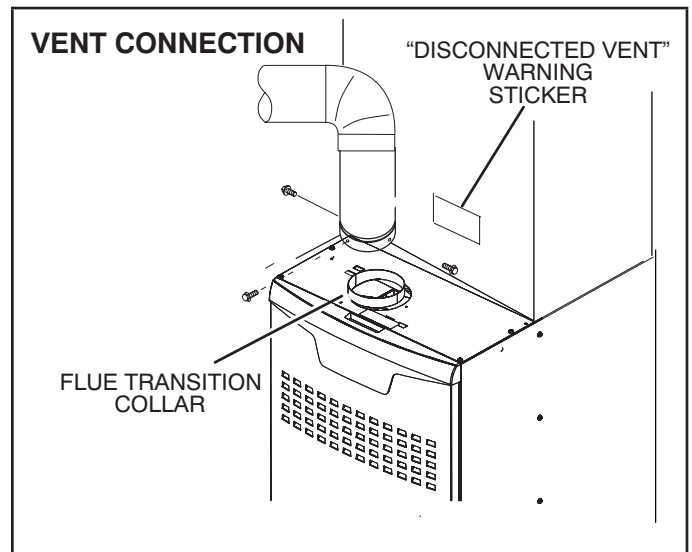

FIGURE 15

Use self-drilling sheet metal screws or a mechanical fastener to firmly secure the vent pipe to the round collar of the flue transition. If self-drilling screws are used to attach the vent pipe, it is recommended that three be used. Drive one self-drilling screw through the front and one through each side of the vent pipe and collar. See FIGURE 15.

Install the first vent connector elbow at a minimum of six inches (152 mm) from the furnace vent outlet. Masonry chimneys used to vent Category I central furnaces must be either tile-lined or lined with a listed metal lining system or dedicated gas vent. Unlined masonry chimneys are prohibited. See FIGURE 16 and FIGURE 17 for common venting.

### Venting Using a Masonry Chimney

The following additional requirements apply when a lined masonry chimney is used to vent this furnace. A chimney with one or more sides exposed to the outside of the structure is considered to be an exterior chimney. An exterior masonry chimney that is not tile-lined must be lined with B1 vent or a listed insulated flexible metal vent.

If the existing chimney will not accommodate a listed metal liner, either the chimney must be rebuilt to accommodate one of these liners or an alternate approved venting method must be found.

Insulation for the flexible vent pipe must be an encapsulated fiberglass sleeve recommended by the flexible vent pipe manufacturer. See FIGURE 17.

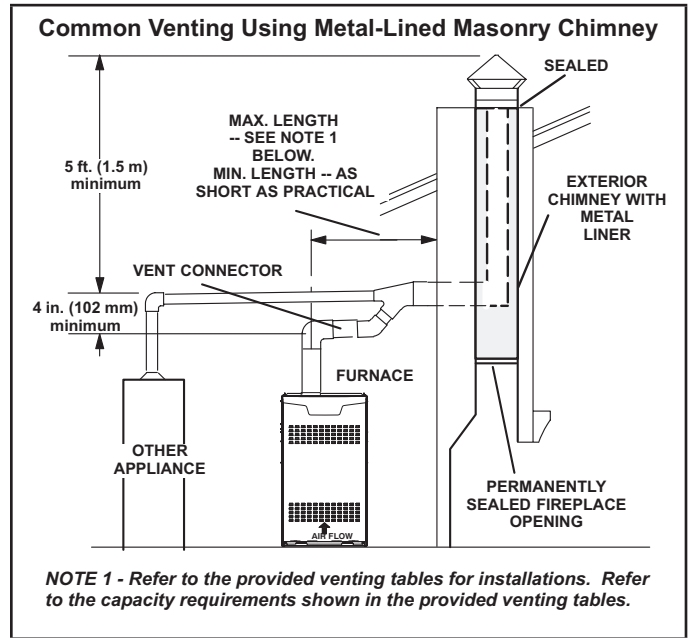

FIGURE 16

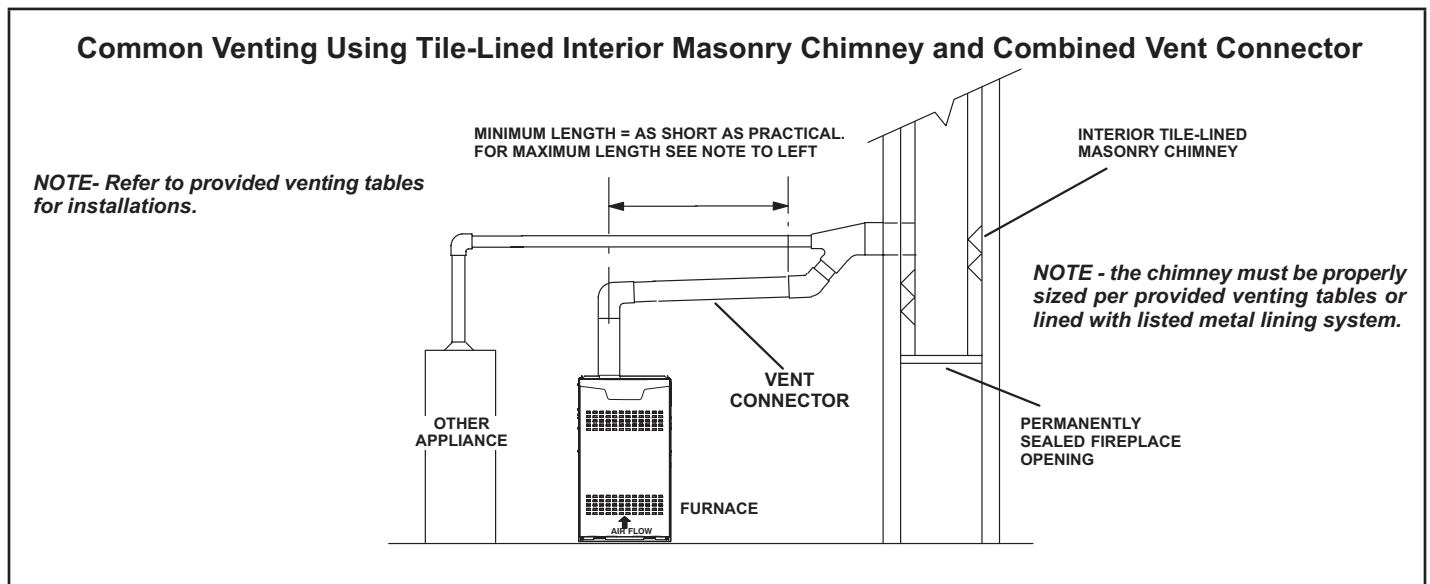

Figure 17

**DO NOT insulate the space between the liner and the chimney wall with puffed mica or any other loose granular insulating material.**

**⚠ IMPORTANT**

**SINGLE appliance venting of a fan-assisted furnace into a tile-lined masonry chimney (interior or outside wall) is PROHIBITED. The chimney must first be lined with either type B1 vent or an insulated single wall flexible vent lining system which has been sized according to the provided venting tables and the vent pipe manufacturer's instructions.**

A fan-assisted furnace may be commonly vented into an existing lined masonry chimney if the following conditions are met:

- The chimney is currently serving at least one draft-hood equipped appliance
- The vent connectors and chimney are sized according to the provided venting tables.

If type B1 double-wall vent is used inside a chimney, no other appliance can be vented into the chimney. The outer wall of type B1 vent pipe must not be exposed to flue products.

A type B1 vent or masonry chimney liner shall terminate above the roof surface with a listed cap or a listed roof assembly according to the terms of their respective listings and the vent manufacturer's instructions.

When inspection reveals that an existing chimney is not safe for the intended purpose, it shall be rebuilt to conform to nationally recognized standards, lined or relined with suitable materials, or replaced with a gas vent or chimney suitable for venting EL280DFE series units. The chimney passageway must be checked periodically to ensure that it is clear and free of obstructions.

Do not install a manual damper, barometric draft regulator, or flue restrictor between the furnace and the chimney. Never connect a Category I appliance to a chimney that is servicing a solid-fuel appliance. If a fireplace chimney flue is used to vent this appliance, the fireplace opening must be permanently sealed.

A type B or listed chimney lining system that passes through an unused masonry chimney flue is not considered to be exposed to the outdoors.

**General Venting Requirements**

Vent all EL280DFE furnaces according to these instructions:

- 1 - Vent diameter recommendations and maximum allowable piping runs are found in the provided venting tables.
- 2 - In no case should the vent or vent connector diameter be less than the diameter specified in the provided venting tables.

- 3 - The minimum vent capacity determined by the sizing tables must be less than the low fire input rating and the maximum vent capacity must be greater than the high fire input rating.
- 4 - Single appliance vents - If the vertical vent or tile-lined chimney has a larger diameter or flow area than the vent connector, use the vertical vent diameter to determine the minimum vent capacity and the vent connector diameter to determine the maximum vent capacity. The flow area of the vertical vent, however, shall not exceed 7 times the flow area of the listed appliance categorized vent area, draft-hood outlet area or flue collar area unless designed according to approved engineering methods.
- 5 - Multiple appliance vents - The flow area of the largest section of vertical vent or chimney shall not exceed 7 times the smallest listed appliance categorized vent area, draft-hood outlet area or flue collar area unless designed according to approved engineering methods.
- 6 - The entire length of single wall metal vent connector shall be readily accessible for inspection, cleaning, and replacement.
- 7 - Single appliance venting configurations with zero lateral lengths (TABLE 5) are assumed to have no elbows in the vent system. For all other vent configurations, the vent system is assumed to have two 90° elbows. For each additional 90° elbow or equivalent (for example two 45° elbows equal one 90° elbow) beyond two, the maximum capacity listed in the venting table should be reduced by 10% (0.90 x maximum listed capacity).
- 8 - The common venting tables (TABLE 6 and TABLE 7) were generated using a maximum horizontal vent connector length of 1-1/2 feet (.46 m) for each inch (25 mm) of connector diameter as follows:

**TABLE 4**

Connector Diameter inches (mm)	Maximum Horizontal Connector Length feet (m)
3 (76)	4-1/2 (1.37)
4 (102)	6 (1.83)
5 (127)	7-1/2 (2.29)
6 (152)	9 (2.74)
7 (178)	10-1/2 (3.20)

- 9 - If the common vertical vent is offset, the maximum common vent capacity listed in the common venting tables should be reduced by 20%, the equivalent of two 90° elbows (0.80 x maximum common vent capacity). The horizontal length of the offset shall not exceed 1-1/2 feet (.46 m) for each inch (25 mm) of common vent diameter.
- 10 - The vent pipe should be as short as possible with the least number of elbows and angles required to complete the job. Route the vent connector to the vent using the shortest possible route.

- 11 - A vent connector shall be supported without any dips or sags and shall slope a minimum of 1/4 inch (6.4 mm) per linear foot (305 mm) of connector, back toward the appliance.
- 12 - Vent connectors shall be firmly attached to the furnace flue collar by self-drilling screws or other approved means, except vent connectors of listed type B vent material which shall be assembled according to the manufacturer's instructions. Joints between sections of single wall connector piping shall be fastened by screws or other approved means.
- 13 - When the vent connector used for Category I appliances must be located in or pass through a crawlspace or other areas which may be cold, that portion of the vent connector shall be constructed of listed double-wall type B vent material or material having equivalent insulation qualities.
- 14 - All venting pipe passing through floors, walls, and ceilings must be installed with the listed clearance to combustible materials and be fire stopped according to local codes. In absence of local codes, refer to NFGC (Z223.1).
- 15 - No portion of the venting system can extend into, or pass through any circulation air duct or plenum.
- 16 - Vent connectors serving Category I appliances shall not be connected to any portion of mechanical draft systems operating under positive pressure such as Category III or IV venting systems.
- 17 - If vent connectors are combined prior to entering the common vent, the maximum common vent capacity listed in the common venting tables must be reduced by 10%, the equivalent of one 90° elbow (0.90 x maximum common vent capacity).
- 18 - The common vent diameter must always be at least as large as the largest vent connector diameter.
- 19 - In no case, shall the vent connector be sized more than two consecutive table size diameters over the size of the draft hood outlet or flue collar outlet.
- 20 - Do not install a manual damper, barometric draft regulator or flue restrictor between the furnace and the chimney.
- 21 - When connecting this appliance to an existing dedicated or common venting system, you must inspect the venting system's general condition and look for signs of corrosion. The existing vent pipe size must conform to these instructions and the provided venting tables. If the existing venting system does not meet these requirements, it must be resized.



**TABLE 5**  
Capacity of Type B Double-Wall Vents with Type B Double-Wall Connectors  
Serving a Single Category I Appliance

Height H (feet)	Lateral L (feet)	Vent and Connector Diameter - D (inches)							
		3 inch		4 inch		5 inch		6 inch	
		Appliance Input Rating in Thousands of Btu Per Hour							
		Min	Max	Min	Max	Min	Max	Min	Max
6	0	0	78	0	152	0	251	0	375
	2	13	51	18	97	27	157	32	232
	4	21	49	30	94	39	153	50	227
	6	25	46	36	91	47	149	59	223
8	0	0	84	0	165	0	276	0	415
	2	12	57	16	109	25	178	28	263
	5	23	53	32	103	42	171	53	255
	8	28	49	39	98	51	164	64	247
10	0	0	88	0	175	0	295	0	447
	2	12	61	17	118	23	194	26	289
	5	23	57	32	113	41	187	52	280
	10	30	51	41	104	54	176	67	267
15	0	0	94	0	191	0	327	0	502
	2	11	69	15	136	20	226	22	339
	5	22	65	30	130	39	219	49	330
	10	29	59	40	121	51	206	64	315
	15	35	53	48	112	61	195	76	301
20	0	0	97	0	202	0	349	0	540
	2	10	75	14	149	18	250	20	377
	5	21	71	29	143	38	242	47	367
	10	28	64	38	133	50	229	62	351
	15	34	58	46	124	59	217	73	337
	20	48	52	55	116	69	206	84	322
30	0	0	100	0	213	0	374	0	587
	2	9	81	13	166	14	283	18	432
	5	21	77	28	160	36	275	45	421
	10	27	70	37	150	48	262	59	405
	15	33	64	44	141	57	249	70	389
	20	56	58	53	132	66	237	80	374
	30	NA	NA	73	113	88	214	104	346

**NOTE** - Single appliance venting configurations with zero lateral lengths are assumed to have no elbows in the vent system. For all other vent configurations, the vent system is assumed to have two 90° elbows. For each additional 90° elbow or equivalent (for example two 45° elbows equal one 90° elbow) beyond two, the maximum capacity listed in the venting table should be reduced by 10 percent (0.90 x maximum listed capacity).

**TABLE 6**

Vent Connector Capacity  
Type B Double-Wall Vents with Type B Double-Wall Connectors  
Serving Two or More Category I Appliances

Height H (feet)	Lateral L (feet)	Vent and Connector Diameter - D (inches)							
		3 inch		4 inch		5 inch		6 inch	
		Appliance Input Rating in Thousands of Btu Per Hour							
		Min	Max	Min	Max	Min	Max	Min	Max
6	1	22	37	35	66	46	106	58	164
	2	23	41	37	75	48	121	60	183
	3	24	44	38	81	49	132	62	199
8	1	22	40	35	72	49	114	64	176
	2	23	44	36	80	51	128	66	195
	3	24	47	37	87	53	139	67	210
10	1	22	43	34	78	49	123	65	189
	2	23	47	36	86	51	136	67	206
	3	24	50	37	92	52	146	69	220
15	1	21	50	33	89	47	142	64	220
	2	22	53	35	96	49	153	66	235
	3	24	55	36	102	51	163	68	248
20	1	21	54	33	99	46	157	62	246
	2	2	57	34	105	48	167	64	259
	3	23	60	35	110	50	176	66	271
30	1	20	62	31	113	45	181	60	288
	2	21	64	33	118	47	190	62	299
	3	22	66	34	123	48	198	64	309

**TABLE 7**

Common Vent Capacity  
Type B Double-Wall Vents with Type B Double-Wall Connectors  
Serving Two or More Category I Appliances

Vent Height H (feet)	Vent and Connector Diameter - D (inches)							
	4 inch		5 inch		7 inch		7 inch	
	Appliance Input Rating in Thousands of Btu Per Hour							
	FAN + FAN	FAN + NAT	FAN + FAN	FAN + NAT	FAN + FAN	FAN + NAT	FAN + FAN	FAN + NAT
6	92	81	140	116	204	161	309	248
8	101	90	155	129	224	178	339	275
10	110	97	169	141	243	194	367	299
15	125	112	195	164	283	228	427	352
20	136	123	215	183	314	255	475	394
30	152	138	244	210	361	297	547	459

## Removal of the Furnace from Common Vent

In the event that an existing furnace is removed from a venting system commonly run with separate gas appliances, the venting system is likely to be too large to properly vent the remaining attached appliances.

Conduct the following test while each appliance is operating and the other appliances (which are not operating) remain connected to the common venting system. If the venting system has been installed improperly, you must correct the system as indicated in the general venting requirements section.

### **WARNING**

#### **CARBON MONOXIDE POISONING HAZARD**

Failure to follow the steps outlined below for each appliance connected to the venting system being placed into operation could result in carbon monoxide poisoning or death.

The following steps shall be followed for each appliance

connected to the venting system being placed into operation, while all other appliances connected to the venting system are not in operation:

- 1 - Seal any unused openings in the common venting system.
- 2 - Inspect the venting system for proper size and horizontal pitch. Determine that there is no blockage, restriction, leakage, corrosion, or other deficiencies which could cause an unsafe condition.
- 3 - Close all building doors and windows and all doors between the space in which the appliances remaining connected to the common venting system are located and other spaces of the building. Turn on clothes dryers and any appliances not connected to the common venting system. Turn on any exhaust fans, such as range hoods and bathroom exhausts, so they will operate at maximum speed. Do not operate a summer exhaust fan. Close fireplace dampers.
- 4 - Follow the lighting instructions. Turn on the appliance that is being inspected. Adjust the thermostat so that the appliance operates continuously.
- 5 - After the main burner has operated for 5 minutes, test for leaks of flue gases at the draft hood relief opening. Use the flame of a match or candle, or smoke from a cigarette, cigar, or pipe.
- 6 - After determining that each appliance connected to the common venting system is venting properly, (step 3) return all doors, windows, exhaust fans, fireplace dampers, and any other gas-burning appliances to their previous mode of operation.
- 7 - If a venting problem is found during any of the preceding tests, the common venting system must be modified to correct the problem. Resize the common venting system to the minimum vent pipe size determined by using the appropriate tables in Appendix G. (These are in the current standards of the National Fuel Gas Code ANSI Z223.1.

## Gas Piping

Gas supply piping should not allow more than 0.5"W.C. drop in pressure between gas meter and unit. Supply gas pipe must not be smaller than unit gas connection.

### **CAUTION**

If a flexible gas connector is required or allowed by the authority that has jurisdiction, black iron pipe shall be installed at the gas valve and extend outside the furnace cabinet. The flexible connector can then be added between the black iron pipe and the gas supply line.

## Gas Supply

### **WARNING**

Do not over torque (800 in-lbs) or under torque (350 in-lbs) when attaching the gas piping to the gas valve.

- 1 - This unit is shipped standard for left or right side installation of gas piping. Connect the gas supply to the piping assembly. The maximum torque is 800 in lbs and minimum torque is 350 in lbs when attaching the gas piping to the gas valve.
- 2 - When connecting the gas supply piping, consider factors such as length of run, number of fittings, and furnace rating to avoid excessive pressure drop. TABLE 8 lists recommended pipe sizes for typical applications.
- 3 - The gas piping must not run in or through air ducts, clothes chutes, gas vents or chimneys, dumb waiters, or elevator shafts.
- 4 - The piping should be sloped 1/4 inch (6.4 mm) per 15 feet (4.57 m) upward toward the meter from the furnace. The piping must be supported at proper intervals [every 8 to 10 feet (2.44 to 3.01 m)] with suitable hangers or straps. Install a drip leg inside vertical pipe runs to the unit.
- 5 - A 1/8" N.P.T. plugged tap or pressure post is located on the gas valve to facilitate test gauge connection. See figure 23.
- 6 - In some localities, codes may require the installation of a manual main shut-off valve and union (furnished by the installer) external to the unit. The union must be of the ground joint type.

### **IMPORTANT**

Compounds used on threaded joints of gas piping must be resistant to the actions of liquified petroleum gases.

**NOTE** - If emergency shutoff is necessary, shut off the main manual gas valve and disconnect main power to the furnace. The installer should properly label these devices.

**TABLE 8**  
**Gas Pipe Capacity - ft<sup>3</sup>/hr (m<sup>3</sup>/hr)**

Nominal Iron Pipe Size Inches (mm)	Internal Diameter inches (mm)	Length of Pipe - feet (m)									
		10 (3.048)	20 (6.096)	30 (9.144)	40 (12.192)	50 (15.240)	60 (18.288)	70 (21.336)	80 (24.384)	90 (27.432)	100 (30.480)
1/2 (12.7)	.622 (17.799)	172 (4.87)	118 (3.34)	95 (2.69)	81 (2.29)	72 (2.03)	65 (1.84)	60 (1.69)	56 (1.58)	52 (1.47)	50 (1.42)
3/4 (19.05)	.824 (20.930)	360 (10.19)	247 (7.000)	199 (5.63)	170 (4.81)	151 (4.23)	137 (3.87)	126 (3.56)	117 (3.31)	110 (3.11)	104 (2.94)
1 (25.4)	1.049 (26.645)	678 (19.19)	466 (13.19)	374 (10.59)	320 (9.06)	284 (8.04)	257 (7.27)	237 (6.71)	220 (6.23)	207 (5.86)	195 (5.52)
1-1/4 (31.75)	1.380 (35.052)	1350 (38.22)	957 (27.09)	768 (22.25)	657 (18.60)	583 (16.50)	528 (14.95)	486 (13.76)	452 (12.79)	424 (12.00)	400 (11.33)
1-1/2 (38.1)	1.610 (40.894)	2090 (59.18)	1430 (40.49)	1150 (32.56)	985 (27.89)	873 (24.72)	791 (22.39)	728 (20.61)	677 (19.17)	635 (17.98)	600 (17.00)
2 (50.8)	2.067 (52.502)	4020 (113.83)	2760 (78.15)	2220 (62.86)	1900 (53.80)	1680 (47.57)	1520 (43.04)	1400 (39.64)	1300 (36.81)	1220 (34.55)	1160 (32.844)
2-1/2 (63.5)	2.469 (67.713)	6400 (181.22)	4400 (124.59)	3530 (99.95)	3020 (85.51)	2680 (75.88)	2480 (70.22)	2230 (63.14)	2080 (58.89)	1950 (55.22)	1840 (52.10)

**NOTE - Capacity given in cubic feet (m<sup>3</sup>) of gas per hour and based on 0.60 specific gravity gas.**

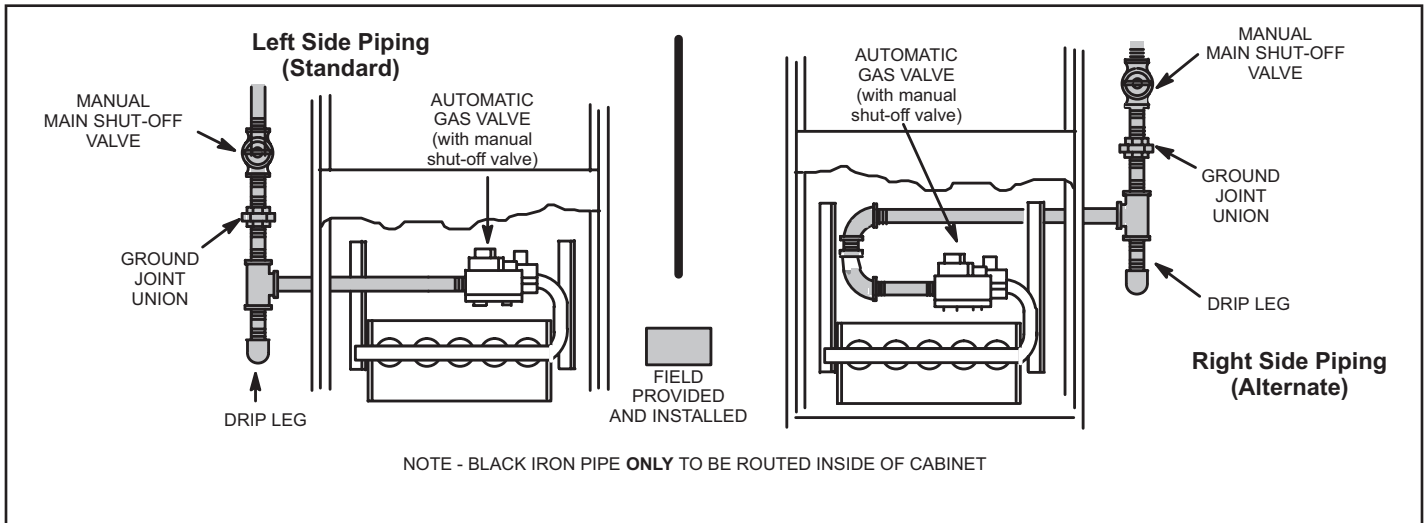

**Figure 18**

## Leak Check

After gas piping is completed, carefully check all field-installed piping connections for gas leaks. Use a commercially available leak detecting solution specifically manufactured for leak detection. Never use an open flame to test for gas leaks.

**NOTE** - If emergency shutoff is necessary, shut off the main manual gas valve and disconnect the main power to the furnace. The installer should properly label these devices.

### ⚠ CAUTION

Some soaps used for leak detection are corrosive to certain metals. Carefully rinse piping thoroughly after leak test has been completed. Do not use matches, candles, flame or other sources of ignition to check for gas leaks.

The furnace must be isolated from the gas supply system by closing the individual manual shut-off valve during any gas supply system at pressures greater than or equal to ½ psig. (3.48 kPa, 14 inches w.c.). This furnace and its components are designed, manufactured and independently certified to comply with all applicable ANSI/CSA standards. A leak check of the furnace and its components is not required.

### ⚠ IMPORTANT

When testing pressure of gas lines, gas valve must be disconnected and isolated. See FIGURE 19. Gas valves can be damaged if subjected to pressures greater than 1/2 psig (3.48 kPa, 14 inches w.c.).

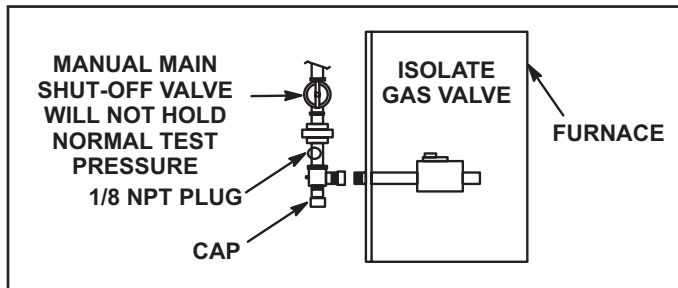

FIGURE 19

## Electrical

### ELECTROSTATIC DISCHARGE (ESD) Precautions and Procedures

### ⚠ CAUTION



Electrostatic discharge can affect electronic components. Take precautions to neutralize electrostatic charge by touching your hand and tools to metal prior to handling the control.

The unit is equipped with a field make-up box on the left hand side of the cabinet. The make-up box may be moved to the right side of the furnace to facilitate installation. If the make-up box is moved to the right hand side, clip the wire ties that bundle the wires together. Secure the excess wire to the existing harness to protect it from damage.

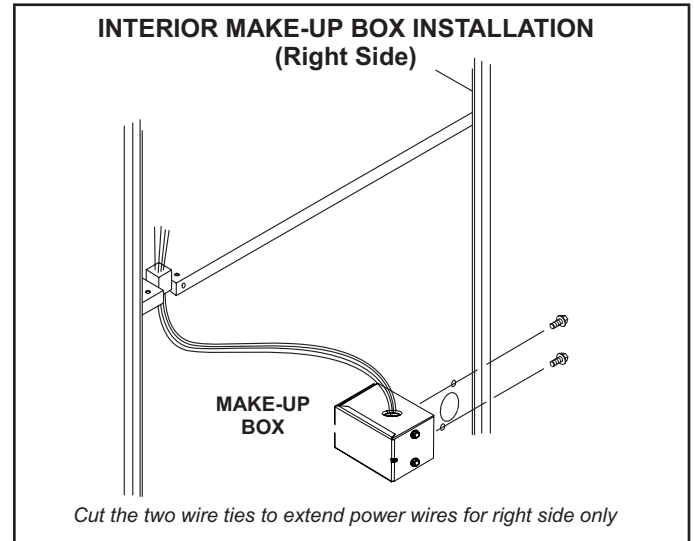

FIGURE 20

Refer to FIGURE 21 or FIGURE 23 for schematic wiring diagram and troubleshooting and TABLE 9 for field wiring.

The power supply wiring must meet Class I restrictions. Protected by either a fuse or circuit breaker, select circuit protection and wire size according to unit nameplate.

### ⚠ WARNING

Fire Hazard. Use of aluminum wire with this product may result in a fire, causing property damage, severe injury or death. Use copper wire only with this product.

### ⚠ CAUTION

Failure to use properly sized wiring and circuit breaker may result in property damage. Size wiring and circuit breaker(s) per Product Specifications bulletin (EHB) and unit rating plate.

**NOTE** - Unit nameplate states maximum current draw. Maximum over-current protection allowed is 15 AMP.

Holes are on both sides of the furnace cabinet to facilitate wiring. Install a separate (properly sized) disconnect switch near the furnace so that power can be turned off for servicing.

Before connecting the thermostat, check to make sure the wires will be long enough for servicing at a later date. Make sure that thermostat wire is long enough to facilitate future removal of blower for service.

Complete the wiring connections to the equipment. Use 18-gauge wire or larger that is suitable for Class II rating for thermostat connections.

Electrically ground the unit according to local codes or, in the absence of local codes, according to the current National Electric Code (ANSI/NFPA No. 70). A green ground wire is provided in the field make-up box.

**NOTE** - The EL280DFE furnace contains electronic components that are polarity sensitive. Make sure that the furnace is wired correctly and is properly grounded.



### Accessory Terminals

One line voltage "EAC" 1/4" spade terminal is provided on the furnace integrated control. See FIGURE 22 or FIGURE 24 for integrated control configuration. This terminal is energized when the indoor blower is operating. Any accessory rated up to one amp can be connected to this terminal with the neutral leg of the circuit being connected to one of the provided neutral terminals. If an accessory rated at greater than one amp is connected to this terminal, it is necessary to use an external relay.

One line voltage "HUM" 1/4" spade terminal is provided on the furnace integrated control. See FIGURE 22 or FIGURE 24 for integrated control configuration. This terminal is energized in the heating mode when the combustion air inducer is operating. Any humidifier rated up to one amp can be connected to this terminal with the neutral leg of the circuit being connected to one of the provided neutral terminals.

If a humidifier rated at greater than one amp is connected to this terminal, it is necessary to use an external relay.

One 24V "H" 1/4" spade terminal is provided on the furnace integrated control. See FIGURE 22 or FIGURE 24 for integrated control configuration. The terminal is energized in the heating mode when the combustion air inducer is operating and the pressure switch is closed. Any humidifier rated up to 0.5 amp can be connected to this terminal with the ground leg of the circuit connected to ground or the "C" terminal.

### Generator Use - Voltage Requirements

The following requirements must be kept in mind when specifying a generator for use with this equipment:

- The furnace requires 120 volts + 10% (Range: 108 volts to 132 volts).
- The furnace operates at 60 Hz + 5% (Range: 57 Hz to 63 Hz).
- The furnace integrated control requires both proper polarity and proper ground. Both polarity and proper grounding should be checked before attempting to operate the furnace on either permanent or temporary power.
- Generator should have a wave form distortion of less than 5% total harmonic distortion (THC).

### Thermostat

Install the room thermostat according to the instructions provided with the thermostat. See table 9 for thermostat designations. If the furnace is being matched with a heat pump, refer to the installation instruction or appropriate dual fuel thermostat instructions.

### Indoor Blower Speeds

- 1 - When the thermostat is set to "FAN ON," the indoor blower will run continuously on the low heat speed when there is no cooling or heating demand. See TABLE 18 for allowable circulation speeds.
- 2 - When the EL280DFE is operating in the high-fire or low-fire heating mode, the indoor blower will run on the corresponding heating speed.
- 3 - When the EL280DFE is operating in the low cool or the high cool cooling mode, the indoor blower will run on the corresponding cooling speed.

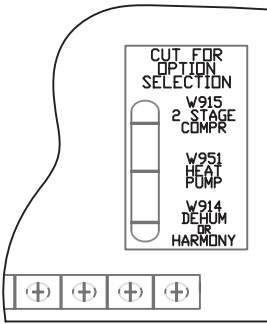
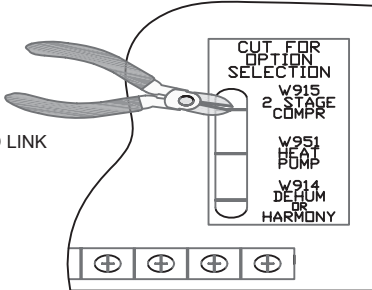
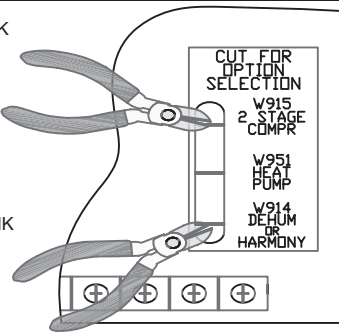

**TABLE 9**  
**Field Wiring Applications With Conventional Thermostat**

Thermostat	DIP Switch Settings and On-Board Links		Wiring Connections																														
	DIP Switch 1 Thermostat Heating Stages	On Board Links Must Be Cut To Select System Options																															
1 Heat / 1 Cool <i>NOTE - Use DIP switch 2 to set second-stage heat ON delay. OFF-7 minutes. ON-12 minutes.</i>	ON	DO NOT CUT ANY ON-BOARD LINKS 	<table border="0"> <tr> <td>S1 T'STAT</td> <td>FURNACE TERM. STRIP</td> <td>OUTDOOR UNIT</td> </tr> <tr> <td></td> <td align="center">DS</td> <td></td> </tr> <tr> <td>W2</td> <td align="center">W2</td> <td></td> </tr> <tr> <td>W1</td> <td align="center">W1</td> <td></td> </tr> <tr> <td>R</td> <td align="center">R</td> <td align="center">* R</td> </tr> <tr> <td>G</td> <td align="center">G</td> <td></td> </tr> <tr> <td>C</td> <td align="center">C</td> <td align="center">C</td> </tr> <tr> <td></td> <td align="center">Y2</td> <td></td> </tr> <tr> <td>Y</td> <td align="center">Y1</td> <td align="center">Y1</td> </tr> <tr> <td></td> <td align="center">O</td> <td></td> </tr> </table>	S1 T'STAT	FURNACE TERM. STRIP	OUTDOOR UNIT		DS		W2	W2		W1	W1		R	R	* R	G	G		C	C	C		Y2		Y	Y1	Y1		O	
S1 T'STAT	FURNACE TERM. STRIP	OUTDOOR UNIT																															
	DS																																
W2	W2																																
W1	W1																																
R	R	* R																															
G	G																																
C	C	C																															
	Y2																																
Y	Y1	Y1																															
	O																																
1 Heat / 2 Cool <i>NOTE - Use DIP switch 2 to set second-stage heat ON delay. OFF-7 minutes. ON-12 minutes.</i>	ON	CUT ON-BOARD LINK W915 2 STAGE COMPR 	<table border="0"> <tr> <td>S1 T'STAT</td> <td>FURNACE TERM. STRIP</td> <td>OUTDOOR UNIT</td> </tr> <tr> <td></td> <td align="center">DS</td> <td></td> </tr> <tr> <td></td> <td align="center">W2</td> <td></td> </tr> <tr> <td>W</td> <td align="center">W1</td> <td></td> </tr> <tr> <td>R</td> <td align="center">R</td> <td align="center">* R</td> </tr> <tr> <td>G</td> <td align="center">G</td> <td></td> </tr> <tr> <td>C</td> <td align="center">C</td> <td align="center">C</td> </tr> <tr> <td>Y2</td> <td align="center">Y2</td> <td align="center">Y2</td> </tr> <tr> <td>Y1</td> <td align="center">Y1</td> <td align="center">Y1</td> </tr> <tr> <td></td> <td align="center">O</td> <td></td> </tr> </table>	S1 T'STAT	FURNACE TERM. STRIP	OUTDOOR UNIT		DS			W2		W	W1		R	R	* R	G	G		C	C	C	Y2	Y2	Y2	Y1	Y1	Y1		O	
S1 T'STAT	FURNACE TERM. STRIP	OUTDOOR UNIT																															
	DS																																
	W2																																
W	W1																																
R	R	* R																															
G	G																																
C	C	C																															
Y2	Y2	Y2																															
Y1	Y1	Y1																															
	O																																
1 Heat / 2 Cool with t'stat with humidity control <i>NOTE - Use DIP switch 2 to set second-stage heat ON delay. OFF-7 minutes. ON-12 minutes.</i>	ON	CUT ON-BOARD LINK W915 2 STAGE COMPR  CUT ON-BOARD LINK W914 DEHUM OR HARMONY 	<table border="0"> <tr> <td>S1 T'STAT</td> <td>FURNACE TERM. STRIP</td> <td>OUTDOOR UNIT</td> </tr> <tr> <td>DS</td> <td align="center">DS</td> <td></td> </tr> <tr> <td></td> <td align="center">W2</td> <td></td> </tr> <tr> <td>W1</td> <td align="center">W1</td> <td></td> </tr> <tr> <td>R</td> <td align="center">R</td> <td align="center">* R</td> </tr> <tr> <td>G</td> <td align="center">G</td> <td></td> </tr> <tr> <td>C</td> <td align="center">C</td> <td align="center">C</td> </tr> <tr> <td>Y2</td> <td align="center">Y2</td> <td align="center">Y2</td> </tr> <tr> <td>Y1</td> <td align="center">Y1</td> <td align="center">Y1</td> </tr> <tr> <td></td> <td align="center">O</td> <td></td> </tr> </table>	S1 T'STAT	FURNACE TERM. STRIP	OUTDOOR UNIT	DS	DS			W2		W1	W1		R	R	* R	G	G		C	C	C	Y2	Y2	Y2	Y1	Y1	Y1		O	
S1 T'STAT	FURNACE TERM. STRIP	OUTDOOR UNIT																															
DS	DS																																
	W2																																
W1	W1																																
R	R	* R																															
G	G																																
C	C	C																															
Y2	Y2	Y2																															
Y1	Y1	Y1																															
	O																																

\* Not required on all units.

**TABLE 9**  
**Field Wiring Applications With Conventional Thermostat (Continued)**

Thermostat	DIP Switch Settings and On-Board Links		Wiring Connections																														
	DIP Switch 1 Thermostat Heating Stages	On Board Links Must Be Cut To Select System Options																															
2 Heat / 2 Cool	OFF	<p>CUT ON-BOARD LINK W915 2 STAGE COMPR</p>	<table border="0"> <tr> <td>S1 T'STAT</td> <td>FURNACE TERM. STRIP</td> <td>OUTDOOR UNIT</td> </tr> <tr> <td></td> <td align="center">DS</td> <td></td> </tr> <tr> <td>W2</td> <td>W2</td> <td></td> </tr> <tr> <td>W1</td> <td>W1</td> <td></td> </tr> <tr> <td>R</td> <td>R</td> <td>* R</td> </tr> <tr> <td>G</td> <td>G</td> <td></td> </tr> <tr> <td>C</td> <td>C</td> <td>C</td> </tr> <tr> <td>Y2</td> <td>Y2</td> <td>Y2</td> </tr> <tr> <td>Y1</td> <td>Y1</td> <td>Y1</td> </tr> <tr> <td></td> <td align="center">O</td> <td></td> </tr> </table>	S1 T'STAT	FURNACE TERM. STRIP	OUTDOOR UNIT		DS		W2	W2		W1	W1		R	R	* R	G	G		C	C	C	Y2	Y2	Y2	Y1	Y1	Y1		O	
S1 T'STAT	FURNACE TERM. STRIP	OUTDOOR UNIT																															
	DS																																
W2	W2																																
W1	W1																																
R	R	* R																															
G	G																																
C	C	C																															
Y2	Y2	Y2																															
Y1	Y1	Y1																															
	O																																
2 Heat / 2 Cool with t'stat with humidity control	OFF	<p>CUT ON-BOARD LINK W915 2 STAGE COMPR</p> <p>CUT ON-BOARD LINK W914 DEHUM OR HARMONY</p>	<table border="0"> <tr> <td>S1 T'STAT</td> <td>FURNACE TERM. STRIP</td> <td>OUTDOOR UNIT</td> </tr> <tr> <td>DS</td> <td>DS</td> <td></td> </tr> <tr> <td>W2</td> <td>W2</td> <td></td> </tr> <tr> <td>W1</td> <td>W1</td> <td></td> </tr> <tr> <td>R</td> <td>R</td> <td>* R</td> </tr> <tr> <td>G</td> <td>G</td> <td></td> </tr> <tr> <td>C</td> <td>C</td> <td>C</td> </tr> <tr> <td>Y2</td> <td>Y2</td> <td>Y2</td> </tr> <tr> <td>Y1</td> <td>Y1</td> <td>Y1</td> </tr> <tr> <td></td> <td align="center">O</td> <td></td> </tr> </table>	S1 T'STAT	FURNACE TERM. STRIP	OUTDOOR UNIT	DS	DS		W2	W2		W1	W1		R	R	* R	G	G		C	C	C	Y2	Y2	Y2	Y1	Y1	Y1		O	
S1 T'STAT	FURNACE TERM. STRIP	OUTDOOR UNIT																															
DS	DS																																
W2	W2																																
W1	W1																																
R	R	* R																															
G	G																																
C	C	C																															
Y2	Y2	Y2																															
Y1	Y1	Y1																															
	O																																
2 Heat / 1 Cool with t'stat with humidity control	OFF	<p>CUT ON-BOARD LINK W914 DEHUM OR HARMONY</p>	<table border="0"> <tr> <td>S1 T'STAT</td> <td>FURNACE TERM. STRIP</td> <td>OUTDOOR UNIT</td> </tr> <tr> <td>DS</td> <td>DS</td> <td></td> </tr> <tr> <td>W2</td> <td>W2</td> <td></td> </tr> <tr> <td>W1</td> <td>W1</td> <td></td> </tr> <tr> <td>R</td> <td>R</td> <td>* R</td> </tr> <tr> <td>G</td> <td>G</td> <td></td> </tr> <tr> <td>C</td> <td>C</td> <td>C</td> </tr> <tr> <td>Y1</td> <td>Y1</td> <td>Y1</td> </tr> <tr> <td></td> <td align="center">O</td> <td></td> </tr> </table>	S1 T'STAT	FURNACE TERM. STRIP	OUTDOOR UNIT	DS	DS		W2	W2		W1	W1		R	R	* R	G	G		C	C	C	Y1	Y1	Y1		O				
S1 T'STAT	FURNACE TERM. STRIP	OUTDOOR UNIT																															
DS	DS																																
W2	W2																																
W1	W1																																
R	R	* R																															
G	G																																
C	C	C																															
Y1	Y1	Y1																															
	O																																
2 Heat / 1 Cool	OFF	<p>DO NOT CUT ANY ON-BOARD LINKS</p>	<table border="0"> <tr> <td>S1 T'STAT</td> <td>FURNACE TERM. STRIP</td> <td>OUTDOOR UNIT</td> </tr> <tr> <td></td> <td align="center">DS</td> <td></td> </tr> <tr> <td>W2</td> <td>W2</td> <td></td> </tr> <tr> <td>W1</td> <td>W1</td> <td></td> </tr> <tr> <td>R</td> <td>R</td> <td>* R</td> </tr> <tr> <td>G</td> <td>G</td> <td></td> </tr> <tr> <td>C</td> <td>C</td> <td>C</td> </tr> <tr> <td></td> <td align="center">Y2</td> <td></td> </tr> <tr> <td>Y</td> <td>Y1</td> <td>Y1</td> </tr> <tr> <td></td> <td align="center">O</td> <td></td> </tr> </table>	S1 T'STAT	FURNACE TERM. STRIP	OUTDOOR UNIT		DS		W2	W2		W1	W1		R	R	* R	G	G		C	C	C		Y2		Y	Y1	Y1		O	
S1 T'STAT	FURNACE TERM. STRIP	OUTDOOR UNIT																															
	DS																																
W2	W2																																
W1	W1																																
R	R	* R																															
G	G																																
C	C	C																															
	Y2																																
Y	Y1	Y1																															
	O																																

\* Not required on all units.

**TABLE 9**  
**Field Wiring Applications With Conventional Thermostat (Continued)**

Thermostat	DIP Switch Settings and On-Board Links		Wiring Connections																																													
	DIP Switch 1 Thermostat Heating Stages	On Board Links Must Be Cut To Select System Options																																														
Dual Fuel Single Stage Heat Pump  ComfortSense thermostat w/ dual fuel capabilities Capable of 2 stage gas heat control	OFF		<table border="0"> <tr> <td>T*STAT</td> <td>FURNACE TERM. STRIP</td> <td>HEAT PUMP</td> </tr> <tr> <td>R</td> <td>R</td> <td>R</td> </tr> <tr> <td>H</td> <td></td> <td></td> </tr> <tr> <td>W2</td> <td>W2</td> <td>67M41*</td> </tr> <tr> <td>W1</td> <td>W1</td> <td>← W1 →</td> </tr> <tr> <td>O</td> <td>O</td> <td>O</td> </tr> <tr> <td>L</td> <td></td> <td>L</td> </tr> <tr> <td>Y1</td> <td>Y1</td> <td>Y</td> </tr> <tr> <td>Y2</td> <td></td> <td></td> </tr> <tr> <td>G</td> <td>G</td> <td></td> </tr> <tr> <td>D</td> <td>DB</td> <td></td> </tr> <tr> <td>B</td> <td>Y2</td> <td></td> </tr> <tr> <td>C</td> <td>C</td> <td>C</td> </tr> <tr> <td>T</td> <td></td> <td>outdoor sensor</td> </tr> <tr> <td>T</td> <td></td> <td></td> </tr> </table>	T*STAT	FURNACE TERM. STRIP	HEAT PUMP	R	R	R	H			W2	W2	67M41*	W1	W1	← W1 →	O	O	O	L		L	Y1	Y1	Y	Y2			G	G		D	DB		B	Y2		C	C	C	T		outdoor sensor	T		
T*STAT	FURNACE TERM. STRIP	HEAT PUMP																																														
R	R	R																																														
H																																																
W2	W2	67M41*																																														
W1	W1	← W1 →																																														
O	O	O																																														
L		L																																														
Y1	Y1	Y																																														
Y2																																																
G	G																																															
D	DB																																															
B	Y2																																															
C	C	C																																														
T		outdoor sensor																																														
T																																																
Dual Fuel Two Stage Heat Pump  ComfortSense thermostat w/ dual fuel capabilities Capable of 2 stage gas heat control	OFF		<table border="0"> <tr> <td>T*STAT</td> <td>FURNACE TERM. STRIP</td> <td>HEAT PUMP</td> </tr> <tr> <td>R</td> <td>R</td> <td>R</td> </tr> <tr> <td>H</td> <td></td> <td></td> </tr> <tr> <td>W2</td> <td>W2</td> <td>67M41*</td> </tr> <tr> <td>W1</td> <td>W1</td> <td>← W1 →</td> </tr> <tr> <td>O</td> <td>O</td> <td>O</td> </tr> <tr> <td>L</td> <td></td> <td>L</td> </tr> <tr> <td>Y1</td> <td>Y1</td> <td>Y1</td> </tr> <tr> <td>Y2</td> <td></td> <td>Y2</td> </tr> <tr> <td>G</td> <td>G</td> <td></td> </tr> <tr> <td>D</td> <td>DB</td> <td>Y2 out blue</td> </tr> <tr> <td>B</td> <td>Y2</td> <td></td> </tr> <tr> <td>C</td> <td>C</td> <td>C</td> </tr> <tr> <td>T</td> <td></td> <td>outdoor sensor</td> </tr> <tr> <td>T</td> <td></td> <td></td> </tr> </table>	T*STAT	FURNACE TERM. STRIP	HEAT PUMP	R	R	R	H			W2	W2	67M41*	W1	W1	← W1 →	O	O	O	L		L	Y1	Y1	Y1	Y2		Y2	G	G		D	DB	Y2 out blue	B	Y2		C	C	C	T		outdoor sensor	T		
T*STAT	FURNACE TERM. STRIP	HEAT PUMP																																														
R	R	R																																														
H																																																
W2	W2	67M41*																																														
W1	W1	← W1 →																																														
O	O	O																																														
L		L																																														
Y1	Y1	Y1																																														
Y2		Y2																																														
G	G																																															
D	DB	Y2 out blue																																														
B	Y2																																															
C	C	C																																														
T		outdoor sensor																																														
T																																																

\* Connect W1 to W1 ONLY if using defrost tempering kit 67M41

NOTE - **Do NOT** make a wire connection between the room thermostat L terminal and the L terminal of the furnace integrated control.

**TABLE 9**  
**Field Wiring Applications With Conventional Thermostat (Continued)**

Thermostat	DIP Switch Settings and On-Board Links		Wiring Connections																																													
	DIP Switch 1 Thermostat Heating Stages	On Board Links Must Be Cut To Select System Options																																														
Dual Fuel Single Stage Heat Pump  ComfortSense thermostat w/ dual fuel capabilities Capable of 2 stage gas heat control w/dehumidification control	OFF	CUT ON-BOARD LINK W951 HEAT PUMP  CUT ON-BOARD LINK W914 DEHUM OR HARMONY  	<table border="0"> <tr> <td>T'STAT</td> <td>FURNACE TERM. STRIP</td> <td>HEAT PUMP</td> </tr> <tr> <td>R</td> <td>R</td> <td>R</td> </tr> <tr> <td>H</td> <td></td> <td></td> </tr> <tr> <td>W2</td> <td>W2</td> <td>67M41*</td> </tr> <tr> <td>W1</td> <td>W1</td> <td>↔ W1</td> </tr> <tr> <td>O</td> <td>O</td> <td>O</td> </tr> <tr> <td>L</td> <td></td> <td>L</td> </tr> <tr> <td>Y1</td> <td>Y1</td> <td>Y</td> </tr> <tr> <td>Y2</td> <td></td> <td></td> </tr> <tr> <td>G</td> <td>G</td> <td></td> </tr> <tr> <td>D</td> <td>DS</td> <td></td> </tr> <tr> <td>B</td> <td>Y2</td> <td></td> </tr> <tr> <td>C</td> <td>C</td> <td>C</td> </tr> <tr> <td>T</td> <td></td> <td>outdoor sensor</td> </tr> <tr> <td>T</td> <td></td> <td></td> </tr> </table>	T'STAT	FURNACE TERM. STRIP	HEAT PUMP	R	R	R	H			W2	W2	67M41*	W1	W1	↔ W1	O	O	O	L		L	Y1	Y1	Y	Y2			G	G		D	DS		B	Y2		C	C	C	T		outdoor sensor	T		
T'STAT	FURNACE TERM. STRIP	HEAT PUMP																																														
R	R	R																																														
H																																																
W2	W2	67M41*																																														
W1	W1	↔ W1																																														
O	O	O																																														
L		L																																														
Y1	Y1	Y																																														
Y2																																																
G	G																																															
D	DS																																															
B	Y2																																															
C	C	C																																														
T		outdoor sensor																																														
T																																																
Dual Fuel Two Stage Heat Pump  ComfortSense thermostat w/ dual fuel capabilities Capable of 2 stage gas heat control w/dehumidification	OFF	CUT ON-BOARD LINK W915 2 STAGE COMPR  CUT ON-BOARD LINK W951 HEAT PUMP  CUT ON-BOARD LINK W914 DEHUM OR HARMONY  	<table border="0"> <tr> <td>T'STAT</td> <td>FURNACE TERM. STRIP</td> <td>HEAT PUMP</td> </tr> <tr> <td>R</td> <td>R</td> <td>R</td> </tr> <tr> <td>H</td> <td></td> <td></td> </tr> <tr> <td>W2</td> <td>W2</td> <td>67M41*</td> </tr> <tr> <td>W1</td> <td>W1</td> <td>↔ W1</td> </tr> <tr> <td>O</td> <td>O</td> <td>O</td> </tr> <tr> <td>L</td> <td></td> <td>L</td> </tr> <tr> <td>Y1</td> <td>Y1</td> <td>Y1</td> </tr> <tr> <td>Y2</td> <td></td> <td>Y2</td> </tr> <tr> <td>G</td> <td>G</td> <td></td> </tr> <tr> <td>D</td> <td>DS</td> <td></td> </tr> <tr> <td>B</td> <td>Y2</td> <td>Y2 out blue</td> </tr> <tr> <td>C</td> <td>C</td> <td>C</td> </tr> <tr> <td>T</td> <td></td> <td>outdoor sensor</td> </tr> <tr> <td>T</td> <td></td> <td></td> </tr> </table>	T'STAT	FURNACE TERM. STRIP	HEAT PUMP	R	R	R	H			W2	W2	67M41*	W1	W1	↔ W1	O	O	O	L		L	Y1	Y1	Y1	Y2		Y2	G	G		D	DS		B	Y2	Y2 out blue	C	C	C	T		outdoor sensor	T		
T'STAT	FURNACE TERM. STRIP	HEAT PUMP																																														
R	R	R																																														
H																																																
W2	W2	67M41*																																														
W1	W1	↔ W1																																														
O	O	O																																														
L		L																																														
Y1	Y1	Y1																																														
Y2		Y2																																														
G	G																																															
D	DS																																															
B	Y2	Y2 out blue																																														
C	C	C																																														
T		outdoor sensor																																														
T																																																

\* Connect W1 to W1 ONLY if using defrost tempering kit 67M41

NOTE - **Do NOT** make a wire connection between the room thermostat L terminal and the L terminal of the furnace integrated control.

## EL280DFE Schematic Wiring Diagram

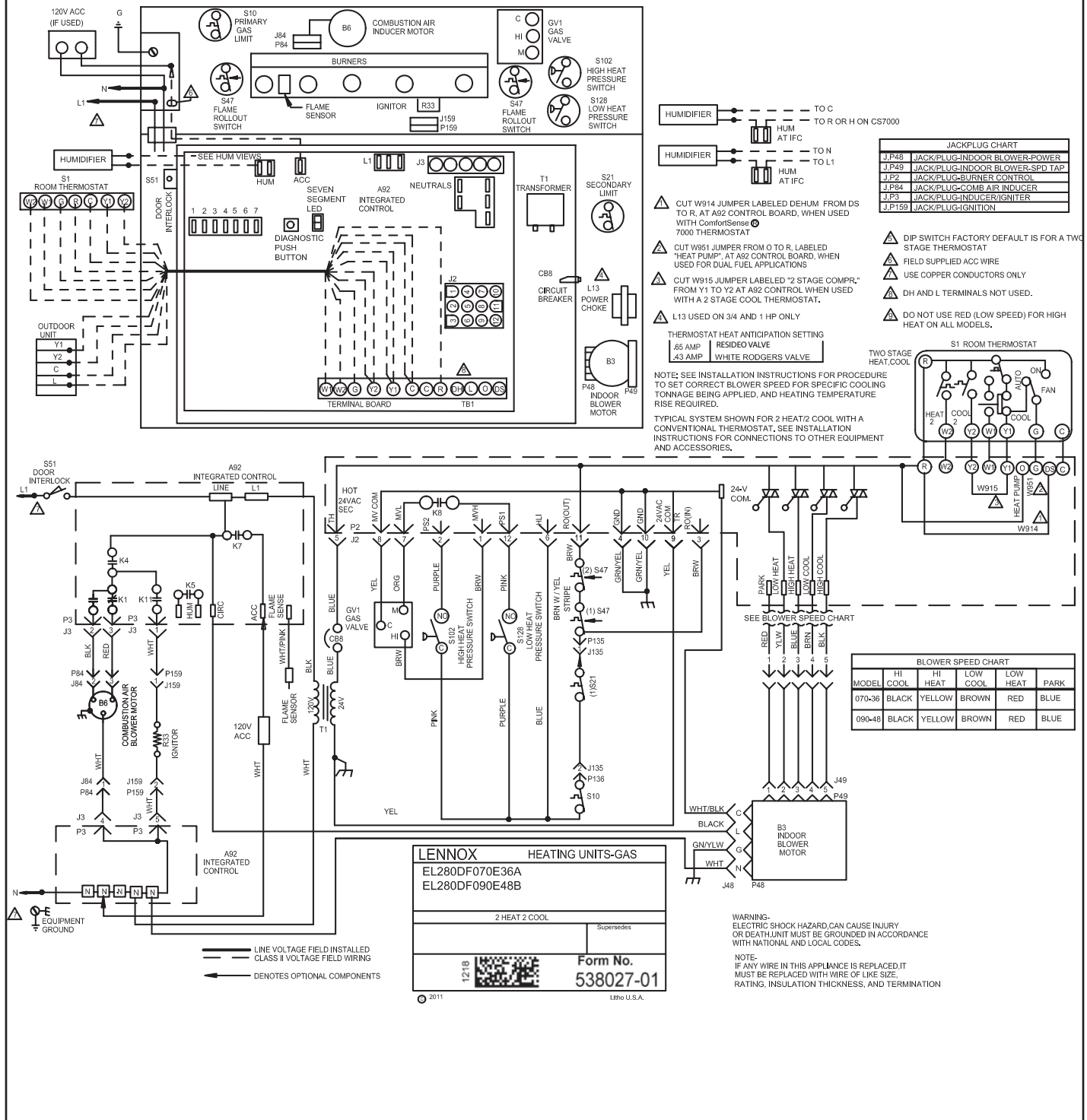
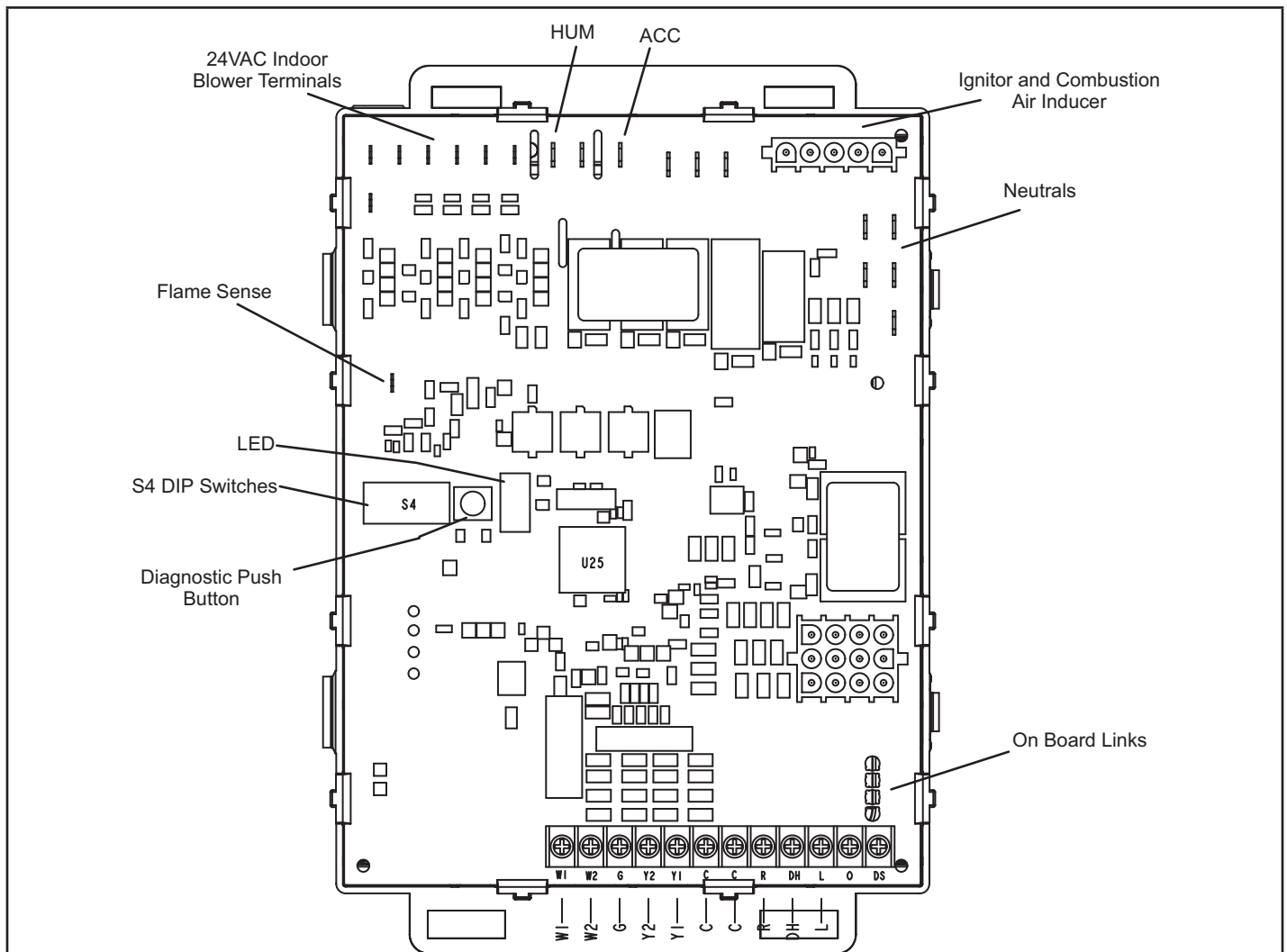

FIGURE 21



**3/16" QUICK CONNECT TERMINALS**

- FLAME SENSE SIGNAL
- HI Cool 24VAC
- HI HEAT 24VAC
- LO COOL 24VAC
- LO HEAT 24VAC
- PARK
- PARK
- COMMON 24VAC

**1/4" QUICK CONNECT TERMINALS**

- NEUTRALS = 120 VAC NEUTRAL
- HUM = UNPOWERED NORMALLY OPEN (DRY) CONTACTS
- LI = 120 VAC INPUT TO CONTROL
- ACC = 120 VAC OUTPUT TO OPTIONAL ACCESSORY

**THERMOSTAT CONNECTIONS (TB1)**

- DS = DEHUMIDIFICATION SIGNAL
- W2 = HEAT DEMAND FROM 2ND STAGE T/STAT
- W1 = HEAT DEMAND FROM 1ST STAGE T/STAT
- R = CLASS 2 VOLTAGE TO THERMOSTAT
- G = MANUAL FAN FROM T'STAT
- C = THERMOSTAT SIGNAL GROUND CONNECTED TO TRANSFORMER GRD (TR) & CHASIS GROUND (GRD)
- Y1 = THERMOSTAT 1ST STAGE COOL SIGNAL
- Y2 = THERMOSTAT 2ND STAGE COOL SIGNAL
- O = THERMOSTAT SIGNAL TO HEAT PUMP REVERSING VALVE
- DH = NOT USED
- L = NOT USED

**FIGURE 22**



# Wiring Diagram With Integrated Control 107048-XX

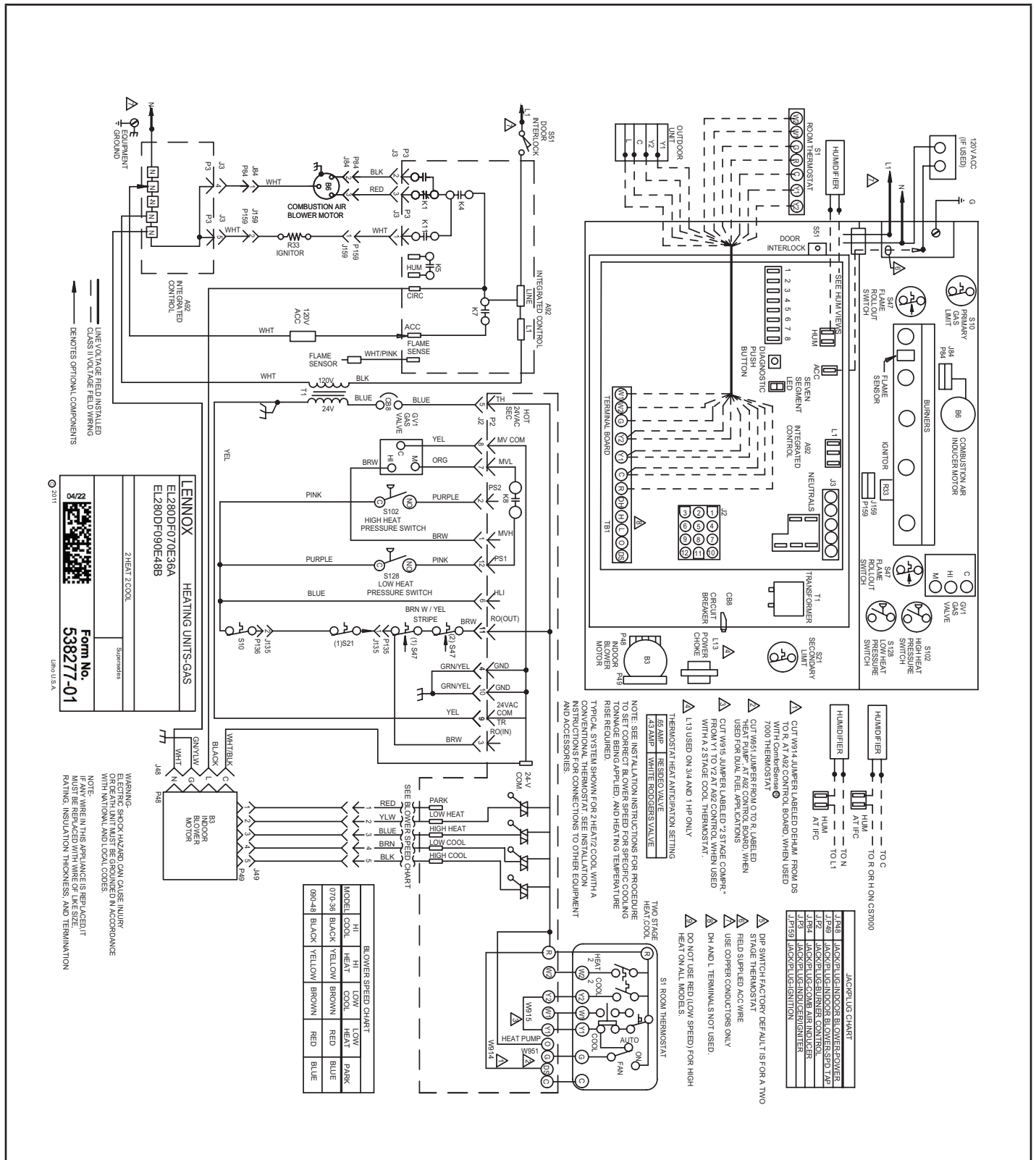
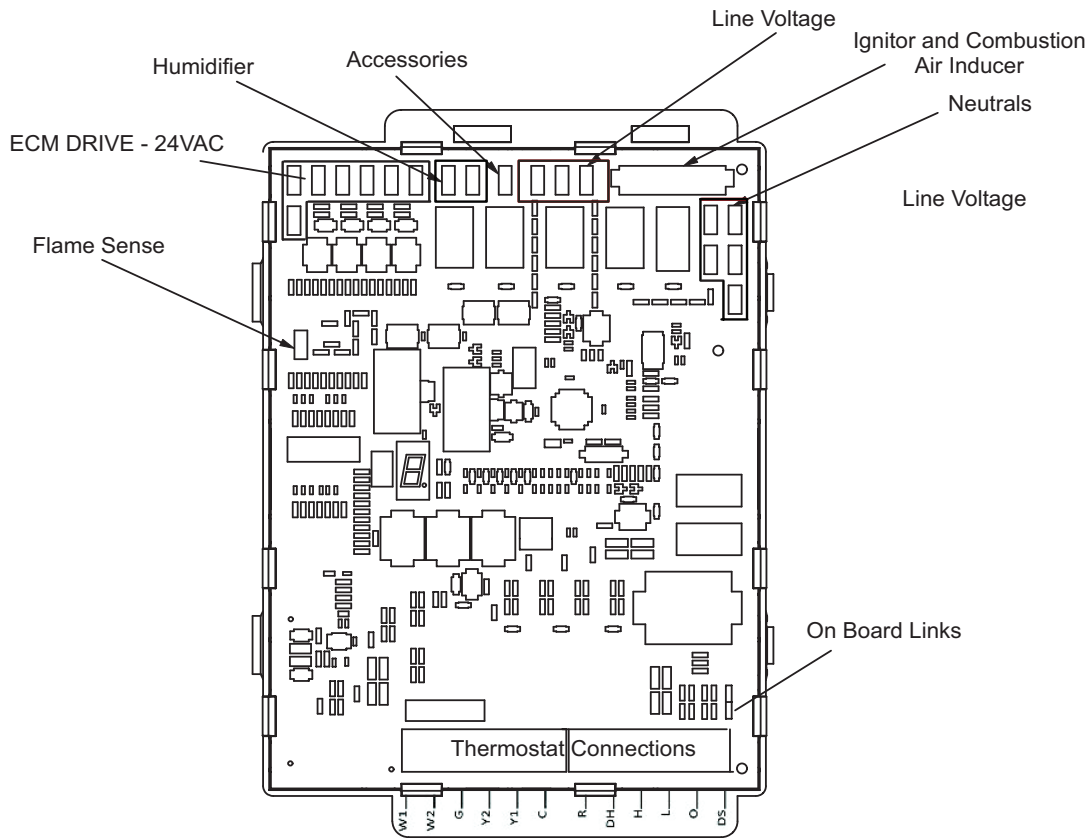

FIGURE 23

UTECH TWO-STAGE CONSTANT TORQUE INTEGRATED FURNACE CONTROL



**3/16" QUICK CONNECT TERMINALS**

- HI COOL (24VAC)
- LO COOL (24VAC)
- HI HEAT (24VAC)
- LO HEAT (24VAC)
- PARK (two un-powered terminals for unused motor speed taps)
- FLAME SENSE

**1/4" QUICK CONNECT TERMINALS**

- HUM (two un-powered, normally open/dry contacts)
- ACC (120VAC output terminal for optional accessory)
- L1 (three 120VAC line terminals)
- Neutrals (five 120VAC neutral terminals)

**THERMOSTAT CONNECTIONS**

- DS= Dehumidification signal
- W2= Heat demand from 2<sup>nd</sup> stage Tstat
- W1= Heat demand from 1<sup>st</sup> stage Tstat (white)
- R= Class 2 voltage to thermostat
- G= Manual fan from Tstat (green)
- C= Tstat signal ground connected to transformer Ground (TR) & Chasis ground (GRD)
- Y1= Tstat 1<sup>st</sup> stage cool signal
- Y2= Tstat 2<sup>nd</sup> stage cool signal
- DH= NOT USED
- H= NOT USED
- L= NOT USED

FIGURE 24

## Integrated Control DIP Switch Settings

EL280DFE units are equipped with a two-stage integrated control. This control manages ignition timing, heating mode fan off delays and indoor blower speeds based on selections made using the control dip switches and jumpers. The control includes an internal watchdog feature which automatically resets the ignition control when it has been locked out. After one hour of continuous thermostat demand for heat, the watchdog will break and remake thermostat demand to the furnace and automatically reset the control to relight the furnace.

### Heating Operation DIP Switch Settings

**NOTE** - Switch 8 is not powered and not used. Switching from on/off will not change any output.

**Switch 1 -- Thermostat Selection** -- This unit may be used with either a single-stage or two-stage thermostat. The thermostat selection is made using a DIP switch which must be properly positioned for the particular application. The DIP switch is factory-positioned for use with a two-stage thermostat. If a single-stage thermostat is to be used, the DIP switch must be repositioned.

- Select "OFF" for two-stage heating operation controlled by a two-stage heating thermostat (factory setting);
- Select "ON" for two-stage heating operation controlled by a single-stage heating thermostat. This setting provides a timed delay before second-stage heat is initiated.

### Switch 2 -- Second Stage Delay (Used with Single-

**Stage Thermostat Only)** -- This switch is used to determine the second stage on delay when a single-stage thermostat is being used. The switch is factory-set in the OFF position, which provides a 7-minute delay before second-stage heat is initiated. If the switch is toggled to the ON position, it will provide a 12-minute delay before second-stage heat is initiated. This switch is only activated when the thermostat selector jumper is positioned for SINGLE-stage thermostat use.

### Indoor Blower Operation DIP Switch Settings

#### Switches 3 and 4 -- Heating Mode Blower-Off Delay --

The blower-on delay of 30 seconds is not adjustable. The blower-off delay (time that the blower operates after the heating demand has been satisfied) can be adjusted by moving switches 3 and 4 on the integrated control. The unit is shipped from the factory with a blower-off delay of 90 seconds.

The blower off delay affects comfort and is adjustable to satisfy individual applications. Adjust the blower off delay to achieve a supply air temperature between 90° and 110°F at the exact moment that the blower is de-energized. Longer off delay settings provide lower supply air temperatures; shorter settings provide higher supply air temperatures. TABLE 10 provides the blower off timings that will result from different switch settings.

**TABLE 10**

**Blower Off Heating Mode Delay Switch Settings**

Blower Off Delay Seconds	Switch 3	Switch 4
60	On	Off
90 (factory)	Off	Off
120	Off	On
180	On	On

**Switch 5 -- Cooling Mode Blower-Off Delay**-- The unit is shipped from the factory with the dip switch positioned OFF for a 45 second delay. TABLE 11 provides the cooling mode off delay settings.

**TABLE 11**

**Blower Off Cooling Mode Delay Switch Settings**

Blower Off Delay Seconds	Switch 5
45 (factory)	Off
2	On

**Switches 6 and 7 -- Continuous Fan Mode** -- Continuous fan speed can be controlled by changing DIP switch positions. TABLE 12 below provides DIP switch settings for continuous fan mode.

**TABLE 12**

**Continuous Fan Mode Settings**

Continuous Fan Mode	Switch 6	Switch 7
Low Heat Speed (Factory Setting)	Off	Off

## On-Board Links and Diagnostic Push Button

### **WARNING**

Carefully review all configuration information provided. Failure to properly set DIP switches, jumpers and on-board links can result in improper operation!

### On-Board Link W914 Dehum

On-board link W914, is a clippable connection between terminals R and DS on the integrated control. W914 must be cut when the furnace is installed with a thermostat which features humidity control. If the link is not cut, terminal "DS" will remain energized not allowing the blower to reduce to low cool speed upon a call for dehumidification.

### On-Board Link W951 Heat Pump (R to O)

On-board link W951 is a clippable connection between terminals R and O on the integrated control. W951 must be cut when the furnace is installed in applications which include a heat pump unit and a thermostat which features dual fuel use. If the link is left intact, terminal "O" will remain energized eliminating the HEAT MODE in the heat pump.

### On-Board Link W915 2 Stage Compr (Y1 to Y2)

On-board link W915 is a clippable connection between terminals Y1 and Y2 on the integrated control. W915 must be cut if two-stage cooling will be used. If the Y1 to Y2 link is not cut the outdoor unit will operate in second-stage cooling only.

### Diagnostic Push Button

The diagnostic push button is located adjacent to the seven-segment diagnostic LED. This button is used to enable the Error Code Recall "E" mode and the Flame Signal "F" mode. Press the button and hold it to cycle through a menu of options. Every five seconds a new menu item will be displayed. When the button is released, the displayed item will be selected. Once all items in the menu have been displayed, the menu resumes from the beginning until the button is released.

### Unit Start-Up

### FOR YOUR SAFETY READ BEFORE LIGHTING

## ⚠ WARNING

Do not use this furnace if any part has been underwater. A flood-damaged furnace is extremely dangerous. Attempts to use the furnace can result in fire or explosion. Immediately call a qualified service technician to inspect the furnace and to replace all gas controls, control system parts, and electrical parts that have been wet or to replace the furnace, if deemed necessary.

## ⚠ WARNING

If overheating occurs or if gas supply fails to shut off, shut off the manual gas valve to the appliance before shutting off electrical supply.

## ⚠ CAUTION

Before attempting to perform any service or maintenance, turn the electrical power to unit OFF at disconnect switch.

**BEFORE LIGHTING** smell all around the appliance area for gas. Be sure to smell next to the floor because some gas is heavier than air and will settle on the floor.

The gas valve on the EL280DFE unit will be equipped with a gas control switch. Use only your hand to move the switch. Never use tools. If the switch will not turn or if the control switch will not move by hand, do not try to repair it.

### Placing the furnace into operation:

EL280DFE units are equipped with an automatic ignition system. Do not attempt to manually light burners on these furnaces. Each time the thermostat calls for heat, the burners will automatically light. The ignitor does not get hot when there is no call for heat on units with an automatic ignition system.

## ⚠ WARNING

If you do not follow these instructions exactly, a fire or explosion may result causing property damage, personal injury or death.

### Gas Valve Operation (FIGURE 25 and FIGURE 26)

- 1 - **STOP!** Read the safety information at the beginning of this section.
- 2 - Set the thermostat to the lowest setting.
- 3 - Turn off all electrical power to the unit.
- 4 - This furnace is equipped with an ignition device which automatically lights the burners. Do not try to light the burners by hand.
- 5 - Remove the upper access panel.
- 6 - Move switch on gas valve to OFF. Do not force. See FIGURE 25 and FIGURE 26.
- 7 - Wait five minutes to clear out any gas. If you then smell gas, STOP! Immediately call your gas supplier from a neighbor's phone. Follow the gas supplier's instructions. If you do not smell gas go to next step.

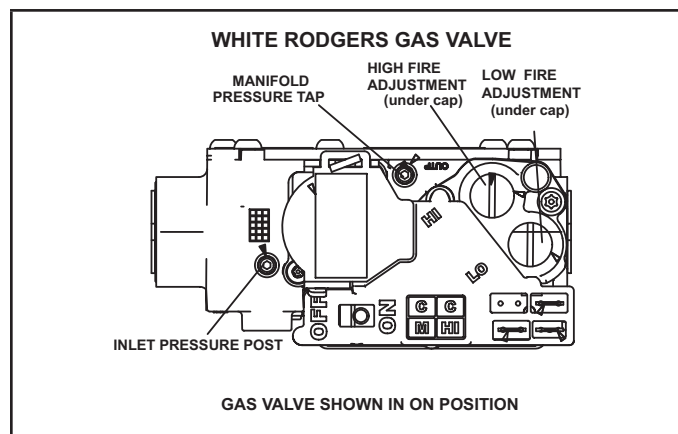
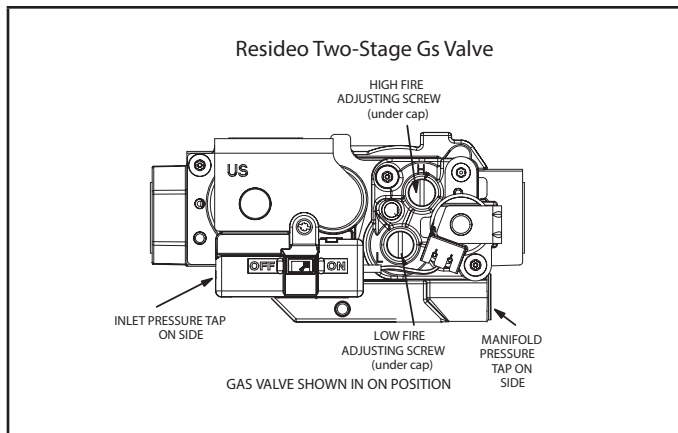

FIGURE 25



**FIGURE 26**

- 8 - Move switch on gas valve to ON. Do not force. See FIGURE 25 and FIGURE 26.
  - 9 - Replace the upper access panel.
  - 10 - Turn on all electrical power to the unit.
  - 11 - Set the thermostat to desired setting.
- NOTE** - When unit is initially started, steps 1 through 11 may need to be repeated to purge air from gas line.
- 12 - If the appliance will not operate, follow the instructions "Turning Off Gas to Unit" and call your service technician or gas supplier.

#### Turning Off Gas to Unit

- 1 - Set the thermostat to the lowest setting.
- 2 - Turn off all electrical power to the unit if service is to be performed.
- 3 - Remove the upper access panel.
- 4 - Move switch on gas valve to OFF. Do not force.
- 5 - Replace the upper access panel.

#### Failure To Operate

If the unit fails to operate, check the following:

- 1 - Is the thermostat calling for heat?
- 2 - Are access panels securely in place?
- 3 - Is the main disconnect switch closed?
- 4 - Is there a blown fuse or tripped circuit breaker?
- 5 - Is the filter dirty or plugged? Dirty or plugged filters will cause the limit control to shut the unit off.
- 6 - Is gas turned on at the meter?
- 7 - Is the manual main shut-off valve open?
- 8 - Is the internal manual shut-off valve open?
- 9 - Is the unit ignition system in lock out? If the unit locks out again, call the service technician to inspect the unit for blockages.
- 10 - Is pressure switch closed? Obstructed flue will cause unit to shut off at pressure switch. Check flue and outlet for blockages.
- 11 - Are flame rollout switches tripped? If flame rollout switches are tripped, call the service technician for inspection.

### Gas Pressure Adjustment

#### Gas Flow (Approximate)

**TABLE 13**

GAS METERING CLOCKING CHART				
EL280DFE Unit	Natural 1000 btu/cu ft		LP 2500 btu/cu ft	
	Seconds For One Revolution			
	1 cu ft dial	2 cu ft dial	1 cu ft Dial	2 cu ft Dial
-070	55	110	136	272
-090	41	82	102	204

Furnace should operate at least 5 minutes before checking gas flow. Determine time in seconds for two revolutions of gas through the meter. (Two revolutions assures a more accurate time.) Divide by two and compare to time in TABLE 13. If manifold pressure matches TABLE 15 and rate is incorrect, check gas orifices for proper size and restriction

Remove temporary gas meter if installed.

**NOTE** - To obtain accurate reading, shut off all other gas appliances connected to meter.

#### Supply Pressure Measurement

An inlet post located on the gas valve provides access to the supply pressure. See FIGURE 25. Back out the 3/32 hex screw one turn, connect a piece of 5/16 tubing and connect to a manometer to measure supply pressure. See table 15 for supply line pressure.

#### Manifold Pressure

A manifold pressure tap located on the gas valve provides access to the manifold pressure. See FIGURE 25. Back out the 3/32 hex screw one turn, connect a piece of 5/16" tubing and connect to a manometer to measure manifold pressure.

**NOTE** - Pressure test adapter kit (10L34) is available from Lennox to facilitate manifold pressure measurement.

- 1 - Connect test gauge to manifold pressure tap on the gas valve.
- 2 - Ignite unit on **low fire** and let run for 5 minutes to allow for steady state conditions.
- 3 - After allowing unit to stabilize for 5 minutes, record manifold pressure and compare to value given in TABLE 15.
- 4 - If necessary, make adjustments. FIGURE 25 shows location of high fire and low fire adjustment screw.
- 5 - Repeat steps 2, 3 and 4 on high fire.
- 6 - Shut unit off and remove manometer as soon as an accurate reading has been obtained. Turn the supply and manifold 3/32" hex screw one revolution back into the gas valve.
- 7 - Start unit and perform leak check. Seal leaks if found.

### Proper Combustion

Furnace should operate minimum 15 minutes with correct manifold pressure and gas flow rate before checking combustion. TABLE 14 shows acceptable combustion for ALL EL280DFE models. **The maximum carbon monoxide reading should not exceed 100 ppm.**

**TABLE 14**

Firing Rate	CO <sub>2</sub> % For Nat	CO <sub>2</sub> % For L.P.
High Fire	6.8 - 7.4	7.5 - 9.0
Low Fire	4.2 - 5.7	5.0 - 6.0

### High Altitude

The manifold pressure may require adjustment and combustion air pressure switch may need replacing to ensure proper combustion at higher altitudes. Refer to TABLE 15 for manifold pressure and TABLE 16 for pressure switch change and gas conversion kits.

## IMPORTANT

**For safety, shut unit off and remove manometer as soon as an accurate reading has been obtained. Take care to replace pressure tap plug.**

**TABLE 15**

### Manifold Pressure Settings at all Altitudes

Unit Input	Gas	Manifold Pressure in. wg. 0 - 4500 ft		Manifold Pressure in. wg. 4501 - 7500 ft		Manifold Pressure in. wg. 7501 - 10,000 ft <sup>2</sup>		Supply Line Pressure in. w.g.	
		Low Fire	High Fire	Low Fire	High Fire	Low Fire	High Fire	Min	Max
070	Natural	1.7	3.5	1.5	3.2	1.7	3.5	4.5	13.0
	LP/propane <sup>3</sup>	4.5	10.0	4.5	10.0	4.5	10.0	11.0	13.0
090	Natural	1.7	3.5	1.5	3.0	1.7	3.5	4.5	13.0
	LP/propane <sup>3</sup>	4.5	10.0	4.5	10.0	4.5	10.0	11.0	13.0

<sup>1</sup> This is the only permissible derate for these units.

<sup>2</sup> Natural gas high altitude orifice kit required.

<sup>3</sup> A natural to L.P. propane gas changeover kit is necessary to convert this unit. Refer to the changeover kit installation instruction for the conversion procedure.

NOTE - Units may be installed at altitudes up to 4500 ft. above sea level without modifications.

**TABLE 16**

### Pressure Switch and Gas Conversion Kits at all Altitudes

Unit Input	High Altitude Pressure Switch Kit			High Altitude Natural Gas Kit	LP/Propane Gas Kit		LP/Propane to Natural Kit
	0-4500 ft	4501- 7500 ft	7501-10,000 ft	7501-10,000 ft	0-7500 ft	7501 - 10,000 ft	0 -7500 ft
070	No Change	No Change	73W36	73W37	11K51	11K46	77W09
090			73W36				

NOTE - A natural to L.P. propane gas changeover kit is necessary to convert this unit. Refer to the changeover kit installation instruction for the conversion procedure.



## Other Unit Adjustments

### Primary and Secondary Limits

The primary limit is located on the heating compartment vestibule panel. The secondary limits (if equipped) are located in the blower compartment, attached to the back side of the blower. These auto reset limits are factory-set and require no adjustment.

### Flame Rollout Switches

The manual reset switch is located on the front of the burner box.

### Pressure Switch

The pressure switch is located in the heating compartment adjacent to the combustion air inducer. The switch checks for proper combustion air inducer operation before allowing ignition trial. The switch is factory-set and requires no adjustment.

### Temperature Rise

After the furnace has been started, and supply and return air temperatures have been allowed to stabilize, check the temperature rise. If necessary, adjust the blower speed to maintain the temperature rise within the range shown on the unit nameplate. See TABLE 17 for allowable heating speeds. Increase the blower speed to decrease the temperature. Decrease the blower speed to increase the temperature rise. Failure to adjust the temperature rise may cause erratic limit operation.

### Input Voltage Requirements

The circuit is designed to be operated with AC voltage. A voltage of 12 to 33VAC is required to energize the motor. Expected current draw will be less than 20mA.

### Blower Speeds

Follow the steps below to change the blower speeds.

- 1 - Turn off electrical power to furnace.
- 2 - Remove blower access panel.
- 3 - Disconnect existing speed tap at integrated control speed terminal.  
**NOTE** - Termination of any unused motor leads must be insulated.
- 4 - Place unused blower speed tap on integrated control "PARK" terminal or insulate.
- 5 - Refer to blower speed selection chart on unit wiring diagram for desired heating or cooling speed. See Blower performance data at the end of this manual and TABLE 17 for allowable heating speeds.
- 6 - Connect selected speed tap at integrated control speed terminal.
- 7 - Resecure blower access panel.
- 8 - Turn on electrical power to furnace.
- 9 - Recheck temperature rise.

## Electronic Ignition

The integrated control has an added feature of an internal Watchguard control. The feature serves as an automatic reset device for integrated control lockout caused by ignition failure. This type of lockout is usually due to low gas line pressure. After one hour of continuous thermostat demand for heat, the Watchguard will break and remake thermostat demand to the furnace and automatically reset the integrated control to begin the ignition sequence.

## Heating Sequence of Operation

### Electronic Ignition

The integrated control used in EL280DFE units has an added feature of an internal Watchguard control. The feature serves as an automatic reset device for ignition control lockout caused by ignition failure. After one hour of continuous thermostat demand for heat, the Watchguard will break and remake thermostat demand to the furnace and automatically reset the control to begin the ignition sequence.

**NOTE** - The ignition control thermostat selection DIP switch is factory-set in the "TWO-STAGE" position.

#### Applications Using a Two-Stage Thermostat

#### A - Heating Sequence -- Integrated Control Thermostat Selection DIP Switch 1 OFF in "Two-Stage" Position (Factory Setting)

- 1 - On a call for heat, thermostat first-stage contacts close sending a signal to the integrated control. The integrated control runs a self-diagnostic program and checks high temperature limit switches for normally closed contacts and pressure switches for normally open contacts. The combustion air inducer is energized at low speed.
- 2 - Once the control receives a signal that the low pressure switch has closed, the combustion air inducer begins a 15-second pre-purge in low speed.  
**NOTE** - If the low fire pressure switch does not close the combustion air inducer will switch to high fire. After a 15 second pre-purge the high fire pressure switch will close and the unit will begin operation on high fire. After 10 to 20 seconds of high fire operation the unit will switch to low fire..
- 3 - After the pre-purge is complete, a 20-second initial ignitor warm-up period begins. The combustion air inducer continues to operate at low speed.
- 4 - After the 20-second warm-up period has ended, the gas valve is energized on low fire (first stage) and ignition occurs. At the same time, the control module sends a signal to begin an indoor blower 30-second ON-delay. When the delay ends, the indoor blower motor is energized on the low fire heating speed, the HUM contacts close energizing the humidifier and 120V ACC terminal is energized. The furnace will continue this operation as long as the thermostat has a first-stage heating demand.
- 5 - If second-stage heat is required, the thermostat second-stage heat contacts close and send a signal to the integrated control. The integrated control initiates a 30-second second-stage recognition delay.

- 6 - At the end of the recognition delay, the integrated control energizes the combustion air inducer at high speed. The control also checks the high fire (second stage) pressure switch to make sure it is closed. The high fire (second stage) gas valve is energized and the indoor blower motor is energized for operation at the high fire heating speed.
- 7 - When the demand for high fire (second stage) heat is satisfied, the combustion air inducer is switched to the low-fire heating speed and the high-fire (second stage) gas valve is de-energized. The low-fire (first stage) gas valve continues operation. The indoor blower motor is switched to the low-fire heating speed.
- 8 - When the thermostat demand for low-fire (first stage) heat is satisfied, the gas valve is de-energized and the field-selected indoor blower off delay begins. The combustion air inducer begins a 5-second post-purge period.
- 9 - When the combustion air post-purge period is complete, the inducer and the HUM contacts are de-energized. The indoor blower is de-energized at the end of the off delay as well as the ACC terminals.

#### Applications Using A Single-Stage Thermostat

#### B - Heating Sequence -- Integrated Control Thermostat election DIP Switch 1 ON in "Single-Stage" Position

**NOTE** - In these applications, two-stage heat will be initiated by the integrated control if heating demand has not been satisfied after the field adjustable period (7 or 12 minutes).

- 1 - On a call for heat, thermostat first-stage contacts close sending a signal to the integrated control. The integrated control runs a self-diagnostic program and checks high temperature limit switches for normally closed contacts and pressure switches for normally open contacts. The combustion air inducer is energized at low speed.
- 2 - Once the control receives a signal that the low pressure switch has closed, the combustion air inducer begins a 15-second pre-purge in low speed.  
**NOTE** - If the low fire pressure switch does not close the combustion air inducer will switch to high fire. After a 15 second pre-purge the high fire pressure switch will close and the unit will begin operation on high fire. After 10 to 20 seconds of high fire operation the unit will switch to low fire.
- 3 - After the pre-purge is complete, a 20-second initial ignitor warm-up period begins. The combustion air inducer continues to operate at low speed.
- 4 - After the 20-second warm-up period has ended, the gas valve is energized on low fire (first stage) and ignition occurs. At the same time, the control module sends a signal to begin an indoor blower 30-second ON-delay. When the delay ends, the indoor blower motor is energized on the low fire heating speed and the HUM contacts are energized. The integrated control also initiates a second-stage on delay (factory-set at 7 minutes; adjustable to 12 minutes).

- 5 - If the heating demand continues beyond the secondstage on delay, the integrated control energizes the combustion air inducer at high speed. The control also checks the high fire (second stage) pressure switch to make sure it is closed. The high fire (second stage) gas valve is energized and the indoor blower motor is energized for operation at the high fire heating speed.
- 6 - When the thermostat heating demand is satisfied, the combustion air inducer begins a 5-second low speed post-purge. The field-selected indoor blower off delay begins. The indoor blower operates at the low-fire heating speed.
- 7 - When the combustion air post-purge period is complete, the inducer and the HUM contacts are de-energized. The indoor blower is de-energized at the end of the off delay as well as the 120 ACC terminals.

#### Service

### **WARNING**

**ELECTRICAL SHOCK, FIRE,  
OR EXPLOSION HAZARD.**

Failure to follow safety warnings exactly could result in dangerous operation, serious injury, death or property damage.

Improper servicing could result in dangerous operation, serious injury, death, or property damage.

Before servicing, disconnect all electrical power to furnace.

When servicing controls, label all wires prior to disconnecting. Take care to reconnect wires correctly. Verify proper operation after servicing.

### **WARNING**

The blower access panel must be securely in place when the blower and burners are operating. Gas fumes, which could contain carbon monoxide, can be drawn into living space resulting in personal injury or death.

#### Annual Furnace Maintenance

At the beginning of each heating season, and to comply with the **Lennox Limited Warranty**, your system should be checked by a licensed professional technician (or equivalent) as follows:

- 1 - Check wiring for loose connections, voltage at indoor unit and amperage of indoor motor.
- 2 - Check the condition of the belt and shaft bearings if applicable.
- 3 - Inspect all gas pipe and connections for leaks.
- 4 - Check the cleanliness of filters and change if necessary (monthly).
- 5 - Check the condition and cleanliness of burners and heat exchanger and clean if necessary.

- 6- Check the cleanliness of blower assembly and clean the housing, blower wheel and blower motor if necessary . The blower motors are prelubricated for extended bearing life. No further lubrication is needed.
- 7- Inspect the combustion air inducer and clean if necessary.
- 8- Evaluate the heat exchanger integrity by inspecting the heat exchanger per the AHRI heat exchanger inspection procedure. This procedure can be viewed at [www.ahrinet.org](http://www.ahrinet.org)
- 9- Ensure sufficient combustion air is available to the furnace. Fresh air grilles and louvers (on the unit and in the room where the furnace is installed) must be properly sized, open and unobstructed to provide combustion air.
- 10- Inspect the furnace venting system to make sure it is in place, structurally sound, and without holes, corrosion, or blockage. Vent system must be free and clear of obstructions and must slope upward away from the furnace . Vent system should be installed per the National Fuel Gas Code
- 11- Inspect the furnace return air duct connection to ensure the duct is sealed to the furnace. Check for air leaks on supply and return ducts and seal where necessary.
- 12- Check the condition of the furnace cabinet insulation and repair if necessary.
- 13- Perform a complete combustion analysis during the furnace inspection to ensure proper combustion and operation. Consult Service Literature for proper combustion values.
- 14- Verify operation of CO detectors and replace batteries as required.

Perform a general system test. Turn on the furnace to check operating functions such as the start-up and shut-off operation.

- 1 - Check the operation of the ignition system, inspect and clean flame sensor. Check microamps before and after. Check controls and safety devices (gas valve, flame sensor, temperature limits). Consult Service Manual for proper operating range. Thermal Limits should be checked by restricting airflow and not disconnecting the indoor blower. For additional details, please see Service and Application Note H049.
- 2 - Verify that system total static pressure and airflow settings are within specific operating parameters.

- 3 - Clock gas meter to ensure that the unit is operating at the specified firing rate. Check the supply pressure and the manifold pressure. On two-stage gas furnaces check the manifold pressure on high fire and low fire. If manifold pressure adjustment is necessary, consult the Service Literature for unit specific information on adjusting gas pressure. Not all gas valves are adjustable. Verify correct temperature rise.

### **Cleaning the Burners**

**NOTE** - Use papers or protective covering in front of the furnace during cleaning.

- 1 - Turn off both electrical and gas power supplies to furnace.
- 2 - Label the wires from gas valve, rollout switches, primary limit switch and make-up box then disconnect them.
- 3 - Disconnect gas supply piping. Remove the four screws securing the burner manifold assembly to the vestibule panel and remove the assembly from the unit.
- 4 - Remove 4 screws securing burner box and remove burner box.
- 5- To clean burners, run a vacuum cleaner with a soft brush attachment over the face of burners. Visually inspect inside the burners and crossovers for any blockage caused by foreign matter. Remove any blockage. FIGURE 26 shows burner detail.
- 6- Reinstall burner box, manifold assembly and burner box cover.
- 7- Reconnect all wires.
- 8- Reconnect gas supply piping.
- 9- Turn on power and gas supply to unit.
- 10- Set thermostat and check for proper operation.
- 11- Check all piping connections, factory and field, for gas leaks. Use a leak detecting solution or other preferred means.

## **CAUTION**

Some soaps used for leak detection are corrosive to certain metals. Carefully rinse piping thoroughly after leak test has been completed. Do not use matches, candles, flame or other sources of ignition to check for gas leaks.

- 12- If a leak is detected, shut gas and electricity off and repair leak.
- 13- Repeat steps 12 and 13 until no leaks are detected.
- 14- Replace access panel.

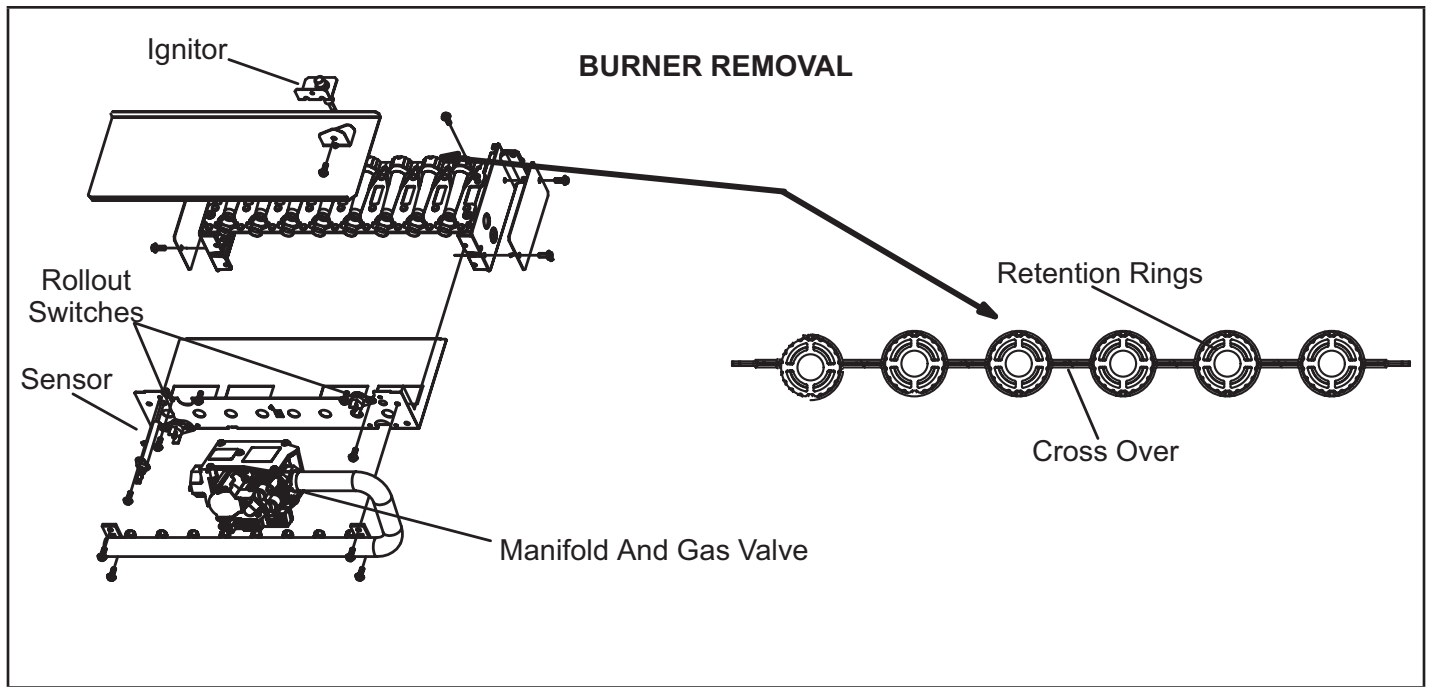

FIGURE 27

## Repair Parts List

The following repair parts are available through independent Lennox dealers. When ordering parts, include the complete furnace model number listed on the CSA International nameplate -- Example: EL280DF070E36A.

**All service must be performed by a licensed professional installer (or equivalent), service agency, or gas supplier**

### Cabinet Parts

- Main access panel
- Blower access panel
- Top cap

### Control Panel Parts

- Transformer
- Integrated control
- Door interlock switch
- Circuit breaker

### Blower Parts

- Blower wheel
- Blower housing
- Motor
- Motor mounting frame
- Blower housing cutoff plate

### Heating Parts

- Flame Sensor
- Heat exchanger assembly
- Gas manifold
- Combustion air inducer
- Gas valve
- Main burner cluster
- Main burner orifices
- Pressure switches
- Ignitor
- Primary limit control
- Flame rollout switch
- Secondary limit

**Start-Up & Performance Check List**

**UNIT SET UP  
(typical)**

Unit Model Number \_\_\_\_\_

Serial Number \_\_\_\_\_

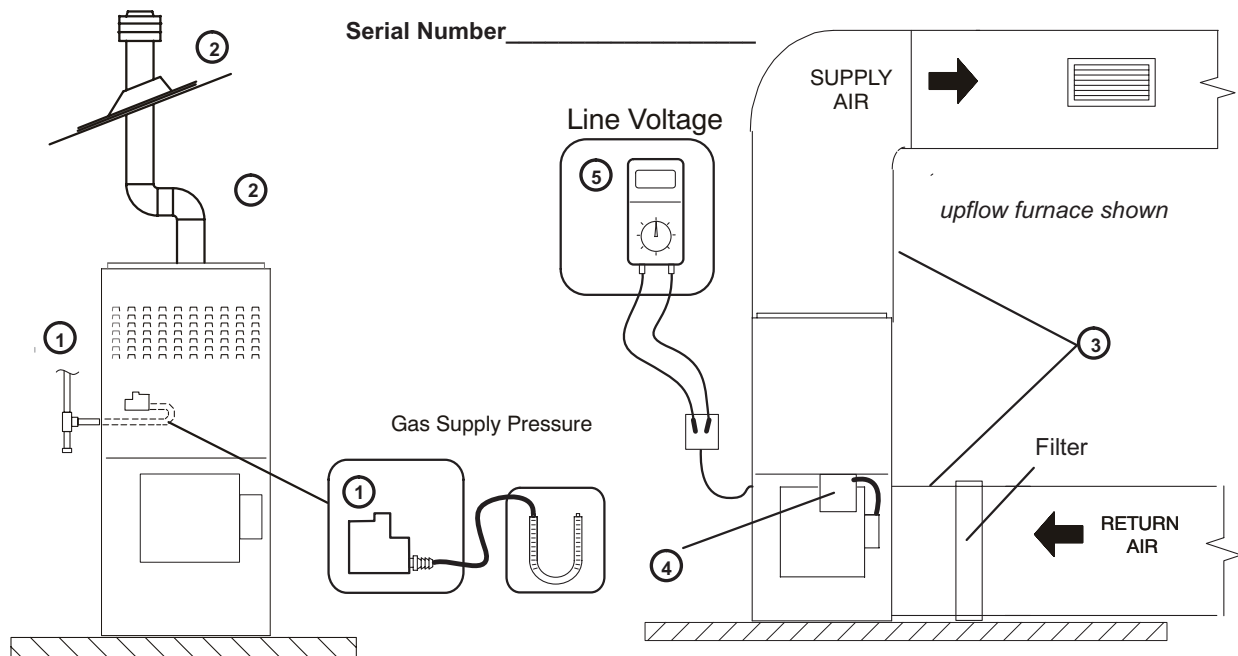

**① GAS SUPPLY**

- Natural Gas     LP/Propane Gas
- Piping Connections Tight
- Leak Tested
- Supply Line Pressure " W.C. \_\_\_\_\_

**② VENT / EXHAUST PIPE**

- Secure to Unit
- Elbows Secured to Pipe
- Roof Flashing (water tight)
- Vent Pipe Supported

**③ DUCT SYSTEM**

**SUPPLY AIR DUCT**

- Sealed
- Insulated (if necessary)
- Registers Open and Unobstructed

**RETURN DUCT**

- Sealed
- Filter Installed and Clean
- Grilles Unobstructed

**④ INTEGRATED CONTROL**

- DIP Switches Set (if applicable)
- Appropriate Links in Place (if applicable)

**⑤ VOLTAGE CHECK**

- Supply Voltage \_\_\_\_\_
- Electrical Connections Tight



**UNIT OPERATION  
(typical)**

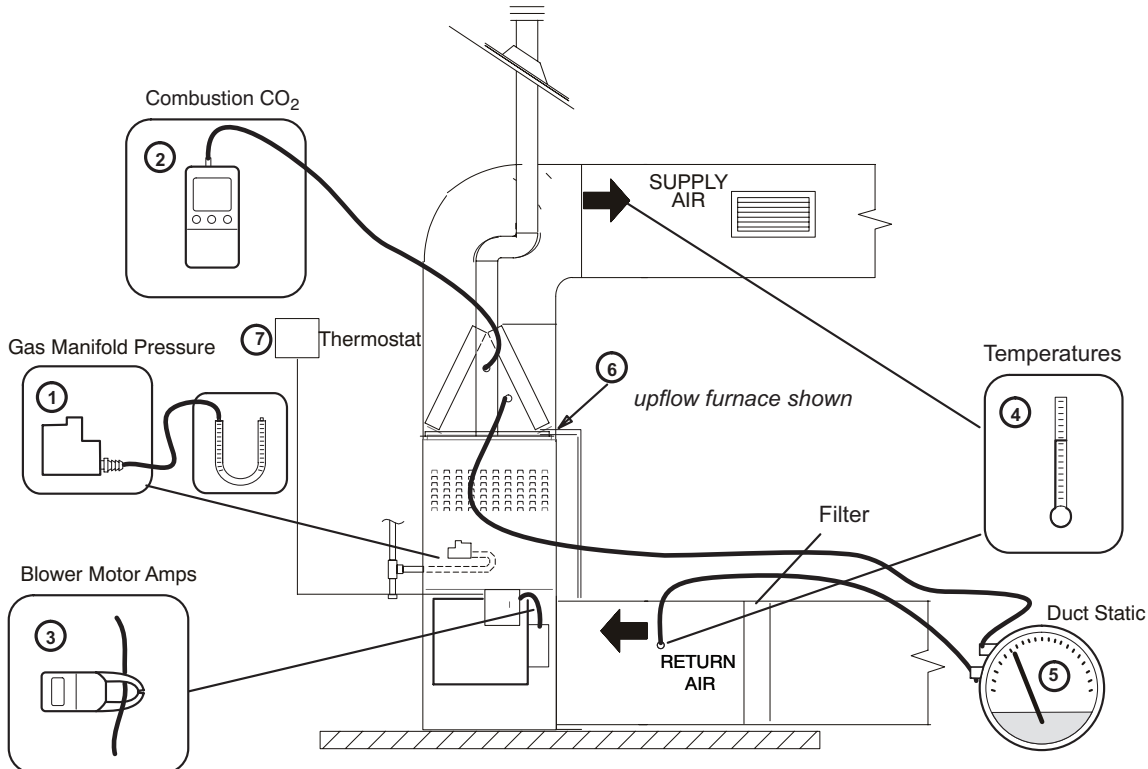

**HEATING MODE**

- ① GAS MANIFOLD PRESSURE "W.C. \_\_\_\_\_
- ② COMBUSTION SAMPLE CO<sub>2</sub>% \_\_\_\_\_ CO PPM \_\_\_\_\_
- ③ INDOOR BLOWER AMPS \_\_\_\_\_
- ④ TEMPERATURE RISE  
 Supply Duct Temperature \_\_\_\_\_  
 Return Duct Temperature - \_\_\_\_\_  
 Temperature Rise = \_\_\_\_\_
- ⑤ TOTAL EXTERNAL STATIC (dry coil)  
 Supply External Static \_\_\_\_\_  
 Return External Static + \_\_\_\_\_  
 Total External Static = \_\_\_\_\_

**COOLING MODE**

- ③ INDOOR BLOWER AMPS \_\_\_\_\_
- ④ TEMPERATURE DROP  
 Return Duct Temperature \_\_\_\_\_  
 Supply Duct Temperature - \_\_\_\_\_  
 Temperature Drop = \_\_\_\_\_
- ⑤ TOTAL EXTERNAL STATIC (dry coil)  
 Supply External Static \_\_\_\_\_  
 Return External Static + \_\_\_\_\_  
 Total External Static = \_\_\_\_\_
- ⑥ DRAIN LINE  
 Leak Free
- ⑦ THERMOSTAT  
 Adjusted and Programmed  
 Operation Explained to Owner

Contractor's: Name \_\_\_\_\_ Telephone \_\_\_\_\_ Checklist Completed \_\_\_\_\_

Job Address \_\_\_\_\_ - \_\_\_\_\_ Technician's Name \_\_\_\_\_

## Blower Data

### EL280DF070E36A PERFORMANCE (Less Filter)

External Static Pressure in. w.g.	Air Volume / Watts at Various Blower Speeds									
	High (Black)		Medium-High (Brown)		Medium (Blue)		Medium-Low (Yellow)		Low (Red)	
	cfm	Watts	cfm	Watts	cfm	Watts	cfm	Watts	cfm	Watts
0.00	1475	346	1345	269	1190	192	970	109	785	71
0.10	1440	355	1325	276	1165	198	935	114	775	74
0.20	1410	365	1280	287	1135	207	905	120	740	79
0.30	1260	401	1250	296	1095	216	855	129	665	86
0.40	1355	380	1225	305	1060	223	815	134	615	92
0.50	1320	394	1200	315	1035	229	770	140	580	97
0.60	1290	401	1160	324	1005	237	745	149	465	105
0.70	1260	410	1130	333	970	245	700	155	445	108
0.80	1215	399	1095	341	935	254	660	158	400	113

### EL280DF090E48B PERFORMANCE (Less Filter)

External Static Pressure in. w.g.	Air Volume / Watts at Various Blower Speeds									
	High (Black)		Medium-High (Brown)		Medium (Blue)		Medium-Low (Yellow)		Low (Red)	
	cfm	Watts	cfm	Watts	cfm	Watts	cfm	Watts	cfm	Watts
0.10	1700	423	1495	293	1380	233	1295	202	1165	156
0.20	1665	436	1455	307	1330	248	1245	211	1110	166
0.30	1620	452	1415	319	1295	257	1195	221	1055	175
0.40	1585	464	1365	328	1225	269	1140	230	985	185
0.50	1560	471	1325	343	1185	277	1090	240	930	193
0.60	1455	475	1275	355	1120	290	1025	252	875	202
0.70	1405	482	1235	365	1075	295	990	259	840	209
0.80	---	---	1160	369	1025	308	925	268	780	217

TABLE 17

Allowable Heating Speeds										
EL280DFE Model Number	Low Fire Heating Speeds					High Fire Heating Speeds				
	Red	Yellow	Blue	Brown	Black	Red	Yellow	Blue	Brown	Black
070E36A	Factory Setting	Allowed	Not Allowed	Not Allowed	Not Allowed	Not Allowed	Factory Setting	Allowed	Allowed	Allowed
090E48B	Factory Setting									

TABLE 18

Allowable Circulation Speeds					
EL280DF Model Number	Red	Yellow	Blue	Brown	Black
070E36A	Factory Setting	Allowed	Not Allowed	Not Allowed	Not Allowed
090E48B					