



© 2022 Lennox Industries Inc.
Dallas, Texas USA



INSTALLATION INSTRUCTIONS SL280DFV

DAVE LENNOX SIGNATURE®
COLLECTION GAS FURNACE
DOWNFLOW AIR DISCHARGE

508246-01
02/2022

**THIS MANUAL MUST BE LEFT WITH THE
HOMEOWNER FOR FUTURE REFERENCE**



⚠ WARNING

Improper installation, adjustment, alteration, service or maintenance can cause property damage, personal injury or loss of life. Installation and service must be performed by a licensed professional HVAC installer or equivalent, service agency, or the gas supplier.

⚠ NOTICE

A thermostat is not included and must be ordered separately.

- A Lennox communicating thermostat must be used in communicating applications.
- In non-communicating applications, the Lennox ComfortSense® 7500 thermostat may be used, as well as other non-communicating thermostats.

In all cases, setup is critical to ensure proper system operation. Field wiring for both communicating and non-communicating applications is illustrated in diagrams, which begin on Page 22.

⚠ CAUTION

As with any mechanical equipment, contact with sharp sheet metal edges can result in personal injury. Take care while handling this equipment and wear gloves and protective clothing.

⚠ This is a safety alert symbol and should never be ignored. When you see this symbol on labels or in manuals, be alert to the potential for personal injury or death.

Contents

Unit Dimensions - inches (mm)	2
Parts Arrangement.....	3
Shipping and Packing List.....	4
Safety Information	4
Use of Furnace as Construction Heater	5
General.....	5
Combustion, Dilution & Ventilation Air	6
Setting Equipment	10
Filters.....	11
Duct System / Venting	12
Gas Piping.....	18
Electrical.....	20

Integrated Control.....	29
Integrated Control DIP Switch Settings -	30
Conventional Thermostat (non-communicating).....	30
Blower Data	33
Unit Start-Up.....	37
Proper Combustion.....	38
High Altitude	39
Heating Sequence of Operation	40
Service.....	42
Repair Parts List.....	43
Integrated Control Diagnostic Modes	44
Program Unit Capacity / Size Mode	51
Troubleshooting: Heating Sequence of Operation	52



Unit Dimensions - inches (mm)

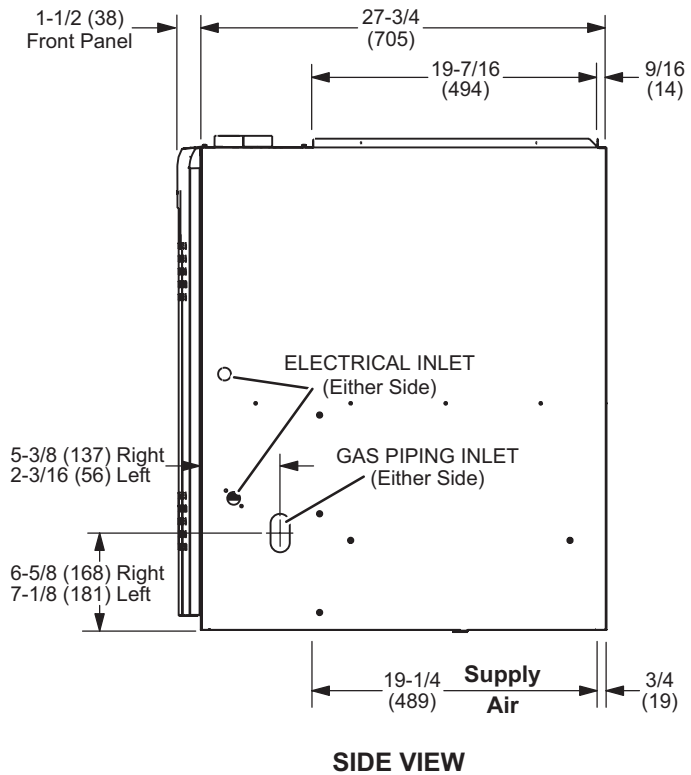
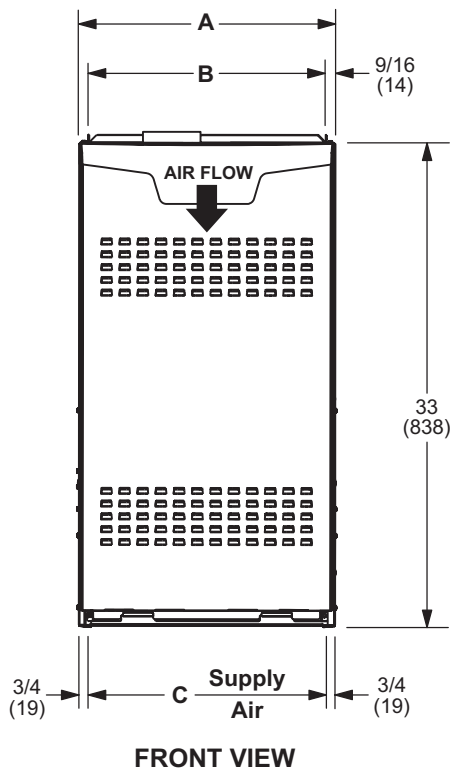
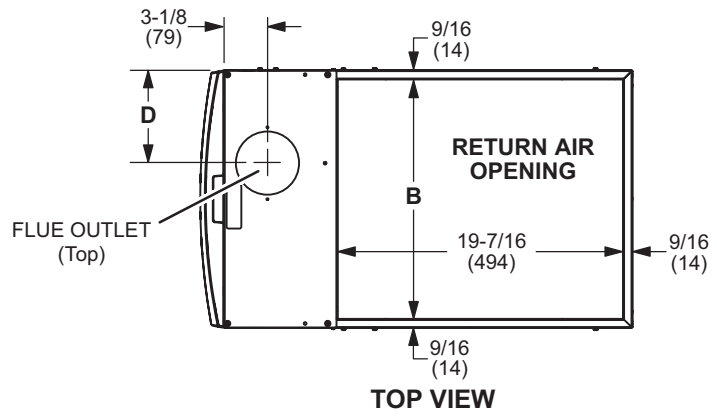

Model	A		B		C		D	
	in	mm	in	mm	in	mm	in	mm
SL280DF070V36A	14-1/2	368	13-3/8	340	13	330	4-3/4	121
SL280DF090V48B	17-1/2	446	16-3/8	416	16	406	6-1/4	159
SL280DF090V60C	21	533	19-7/8	504	19-1/2	495	8	203
SL280DF110V60V								

Parts Arrangement

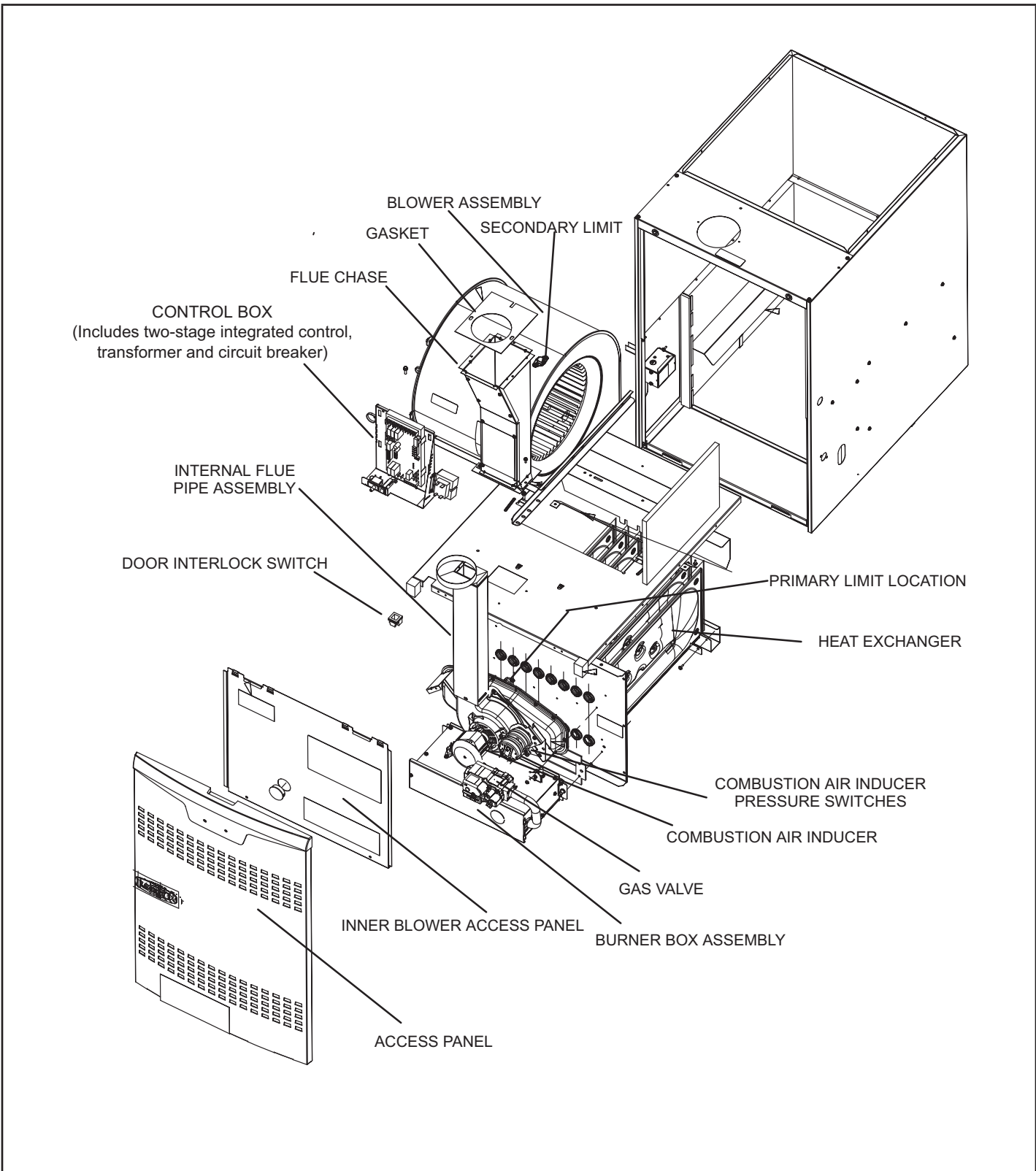

SL280DFV Gas Furnace

The SL280DFV gas furnace is equipped with a two-stage, variable speed integrated control. The control is compatible with:

Lennox communicating thermostats.

Non-communicating thermostats - ComfortSense or other conventional thermostats.

Control systems - Harmony III™ Zone Control System (non-communicating). Each SL280DFV unit is shipped ready for installation in the downflow position.

Shipping and Packing List

Shipping and Packing List

Package 1 of 1 contains

- 1 - Assembled SL280DFV unit
- 1 - Bag assembly containing the following:
 - 2 - Screws
 - 1 - Snap bushing
 - 1 - Snap plug
 - 1 - Wire tie
 - 1 - Vent warning label
 - 1 - Owner's manual and warranty card

The following items may be ordered separately:

- 1 - Thermostat
- 1 - Propane/LP changeover kit
- 1 - Combustible flooring base

Check equipment for shipping damage. If you find any damage, immediately contact the last carrier.

Safety Information

DANGER

Danger of explosion..

There are circumstances in which odorant used with LP/propane gas can lose its scent. In case of a leak, LP/propane gas will settle close to the floor and may be difficult to smell. An LP/propane leak detector should be installed in all LP applications..

WARNING

Improper installation, adjustment, alteration, service or maintenance can cause property damage, personal injury or loss of life. Installation and service must be performed by a licensed professional installer (or equivalent), service agency or the gas supplier.

CAUTION

As with any mechanical equipment, personal injury can result from contact with sharp sheet metal edges. Be careful when you handle this equipment.

Certifications

SL280DFV units are CSA International certified.

In the USA, installation of gas furnaces must conform with local building codes. In the absence of local codes, units must be installed according to the current National Fuel Gas Code (ANSI-Z223.1). The National Fuel Gas Code is available from the following address:

American National Standards Institute, Inc.

11 West 42nd Street

New York, NY 10036

Clearances

Adequate clearance must be made around the air openings into the vestibule area. In order to ensure proper unit operation, combustion and ventilation air supply must be provided according to the current National Fuel Gas Code. Vent installations must be consistent with the venting tables (in this instruction) and applicable provisions of local building codes.

This furnace is CSA International certified for installation clearances to combustible material as listed on the unit nameplate and in the tables in FIGURE 13. Accessibility and service clearances must take precedence over fire protection clearances.

Installed Locations

For installation in a residential garage, the furnace must be installed so that the burner(s) and the ignition source are located no less than 18 inches (457 mm) above the floor. The furnace must be located or protected to avoid physical damage by vehicles. When a furnace is installed in a public garage, hangar, or other building that has a hazardous atmosphere, the furnace must be installed according to recommended good practice requirements and current National Fuel Gas Code.

NOTE - Furnace must be adjusted to obtain a temperature rise (high and low fire) within the range(s) specified on the unit nameplate. Failure to do so may cause erratic limit operation and may also result in premature heat exchanger failure.

This SL280DFV furnace must be installed so that its electrical components are protected from water.

Installed in Combination with a Cooling Coil

When this furnace is used with cooling units, it shall be installed in parallel with, or on the upstream side of, cooling units to avoid condensation in the heating compartment. With a parallel flow arrangement, a damper (or other means to control the flow of air) must adequately prevent chilled air from entering the furnace (FIGURE 1). If the damper is manually operated, it must be equipped to prevent operation of either the heating or the cooling unit, unless it is in the full **HEAT** or **COOL** setting.

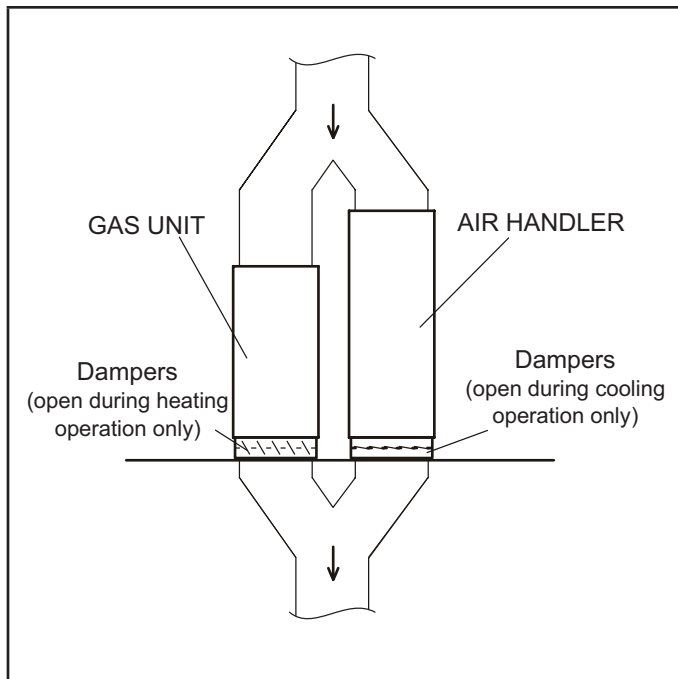

FIGURE 1

When installed, this furnace must be electrically grounded according to local codes. In addition, in the United States, installation must conform with the current National Electric Code, ANSI/NFPA No. 70. The National Electric Code (ANSI/NFPA No. 70) is available from the following address:

National Fire Protection Association
1 Battery March Park
Quincy, MA 02269

NOTE - This furnace is designed for a minimum continuous return air temperature of 60°F (16°C) or an intermittent operation down to 55°F (13°C) dry bulb for cases where a night setback thermostat is used. Return air temperature must not exceed 85°F (29°C) dry bulb.

The SL280DFV furnace may be installed in alcoves, closets, attics, basements, garages, and utility rooms in the downflow position.

This furnace design has not been CSA International certified for installation in mobile homes, recreational vehicles, or outdoors.

Use of Furnace as Construction Heater

Lennox does not recommend the use of SL280DFV units as a construction heater during any phase of construction. Very low return air temperatures, harmful vapors and operation of the unit with clogged or misplaced filters will damage the unit.

SL280DFV units may be used for heating of buildings or structures under construction, if the following conditions are met:

- The vent system must be permanently installed per these installation instructions.
- A room thermostat must control the furnace. The use of fixed jumpers that will provide continuous heating is not allowed.
- The return air duct must be provided and sealed to the furnace.
- Return air temperature range between 60°F (16°C) and 80°F (27°C) must be maintained.
- Air filters must be installed in the system and must be maintained during construction.
- Air filters must be replaced upon construction completion.
- The input rate and temperature rise must be set per the furnace rating plate.
- One hundred percent (100%) outdoor air must be provided for combustion air requirements during construction. Temporary ducting may supply outdoor air to the furnace. Do not connect duct directly to the furnace. Size the temporary duct following these instructions in section for Combustion, Dilution and Ventilation Air in a confined space with air from outside.
- The furnace heat exchanger, components, duct system, air filters and evaporator coils must be thoroughly cleaned following final construction clean-up.
- All furnace operating conditions (including ignition, input rate, temperature rise and venting) must be verified according to these installation instructions.

General

These instructions are intended as a general guide and do not supersede local codes in any way. Consult authorities having jurisdiction before installation.

In addition to the requirements outlined previously, the following general recommendations must be considered when installing a SL280DFV furnace:

- Place the furnace as close to the center of the air distribution system as possible. The furnace should also be located close to the chimney or vent termination point.
- Do not install the furnace where drafts might blow directly into it. This could cause improper combustion and unsafe operation.
- Do not block the furnace combustion air openings with clothing, boxes, doors, etc. Air is needed for proper combustion and safe unit operation.
- When the furnace is installed in an attic or other insulated space, keep insulation away from the furnace.

NOTE - The Commonwealth of Massachusetts stipulates these additional requirements:

- Gas furnaces shall be installed by a licensed plumber or fitter only.
- The gas cock must be “T handle” type.
- When a furnace is installed in an attic, the passage-way to and service area surrounding the equipment shall be floored.

Combustion, Dilution & Ventilation Air

In the past, there was no problem in bringing in sufficient outdoor air for combustion. Infiltration provided all the air that was needed. In today’s homes, tight construction practices make it necessary to bring in air from outside for combustion. Take into account that exhaust fans, appliance vents, chimneys, and fireplaces force additional air that could be used for combustion out of the house. Unless outside air is brought into the house for combustion, negative pressure (outside pressure is greater than inside pressure) will build to the point that a downdraft can occur in the furnace vent pipe or chimney. As a result, combustion gases enter the living space creating a potentially dangerous situation.

In the absence of local codes concerning air for combustion and ventilation, use the guidelines and procedures in this section to install SL280DFV furnaces to ensure efficient and safe operation. You must consider combustion air needs and requirements for exhaust vents. A portion of this information has been reprinted with permission from the National Fuel Gas Code (ANSI-Z223.1). This reprinted material is not the complete and official position of the ANSI on the referenced subject, which is represented only by the standard in its entirety.

CAUTION

Do not install the furnace in a corrosive or contaminated atmosphere. Meet all combustion and ventilation air requirements, as well as all local codes.

CAUTION

Insufficient combustion air can cause headaches, nausea, dizziness or asphyxiation. It will also cause excess water in the heat exchanger resulting in rusting and premature heat exchanger failure. Excessive exposure to contaminated combustion air will result in safety and performance related problems. Avoid exposure to the following substances in the combustion air supply:

- Permanent wave solutions
- Chlorinated waxes and cleaners
- Chlorine base swimming pool chemicals
- Water softening chemicals
- De-icing salts or chemicals
- Carbon tetrachloride
- Halogen type refrigerants
- Cleaning solvents (such as perchloroethylene)
- Printing inks, paint removers, varnishes, etc.
- Hydrochloric acid
- Cements and glues
- Antistatic fabric softeners for clothes dryers
- Masonry acid washing materials

All gas-fired appliances require air for the combustion process. If sufficient combustion air is not available, the furnace or other appliances will operate inefficiently and unsafely. Enough air must be provided to meet the needs of all fuel-burning appliances and appliances such as exhaust fans which force air out of the house. When fireplaces, exhaust fans, or clothes dryers are used at the same time as the furnace, much more air is necessary to ensure proper combustion and to prevent a downdraft. Insufficient air causes incomplete combustion which can result in carbon monoxide.

In addition to providing combustion air, fresh outdoor air dilutes contaminants in the indoor air. These contaminants may include bleaches, adhesives, detergents, solvents and other contaminants which can corrode furnace components. The requirements for providing air for combustion and ventilation depend largely on whether the furnace is installed in an unconfined or a confined space.

Unconfined Space

An unconfined space is an area such as a basement or large equipment room with a volume greater than 50 cubic feet (1.42 m³) per 1,000 Btu (.29 kW) per hour of the combined input rating of all appliances installed in that space. This space also includes adjacent rooms which are not separated by a door. Though an area may appear to be unconfined, it might be necessary to bring in outdoor air for combustion if the structure does not provide enough air by infiltration. If the furnace is located in a building of tight construction with weather stripping and caulking around the windows and doors, follow the procedures in the air from outside section.

Confined Space

A confined space is an area with a volume less than 50 cubic feet (1.42 m³) per 1,000 Btu (.29 kW) per hour of the combined input rating of all appliances installed in that space. This definition includes furnace closets or small equipment rooms.

When the furnace is installed so that supply ducts carry air circulated by the furnace to areas outside the space containing the furnace, the return air must be handled by ducts which are sealed to the furnace casing and which terminate outside the space containing the furnace. This is especially important when the furnace is mounted on a platform in a confined space such as a closet or small equipment room.

Even a small leak around the base of the unit at the platform or at the return air duct connection can cause a potentially dangerous negative pressure condition. Air for combustion and ventilation can be brought into the confined space either from inside the building or from outside.

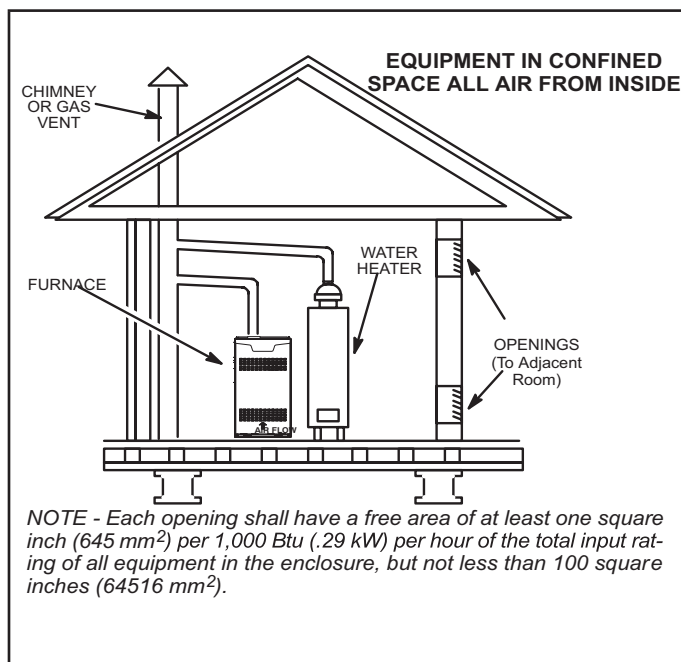

FIGURE 2

Air from Inside

If the confined space that houses the furnace adjoins a space categorized as unconfined, air can be brought in by providing two permanent openings between the two spaces. Each opening must have a minimum free area of 1 square inch (645 mm²) per 1,000 Btu (.29 kW) per hour of total input rating of all gas-fired equipment in the confined space. Each opening must be at least 100 square inches (64516 mm²). One opening shall be within 12 inches (305 mm) of the top of the enclosure and one opening within 12 inches (305 mm) of the bottom. See FIGURE 2.

Air from Outside

If air from outside is brought in for combustion and ventilation, the confined space must have two permanent openings. One opening shall be within 12 inches (305 mm) of the top of the enclosure and one opening within 12 inches (305 mm) of the bottom. These openings must communicate directly or by ducts with the outdoors or spaces (crawl or attic) that freely communicate with the outdoors or indirectly through vertical ducts. Each opening shall have a minimum free area of 1 square inch (645 mm²) per 4,000 Btu (1.17 kW) per hour of total input rating of all equipment in the enclosure. See FIGURE 3 and FIGURE 4. When communicating with the outdoors through horizontal ducts, each opening shall have a minimum free area of 1 square inch (645 mm²) per 2,000 Btu (.56 kW) per total input rating of all equipment in the enclosure. See FIGURE 5.

When ducts are used, they shall be of the same cross-sectional area as the free area of the openings to which they connect. The minimum dimension of rectangular air ducts shall be no less than 3 inches (75 mm). In calculating free area, the blocking effect of louvers, grilles, or screens must be considered. If the design and free area of protective covering is not known for calculating the size opening required, it may be assumed that wood louvers will have 20 to 25 percent free area and metal louvers and grilles will have 60 to 75 percent free area. Louvers and grilles must be fixed in the open position or interlocked with the equipment so that they are opened automatically during equipment operation.

**EQUIPMENT IN CONFINED SPACE
ALL AIR FROM OUTSIDE
(Inlet Air from Crawlspace and Outlet Air to Ventilated Attic)**

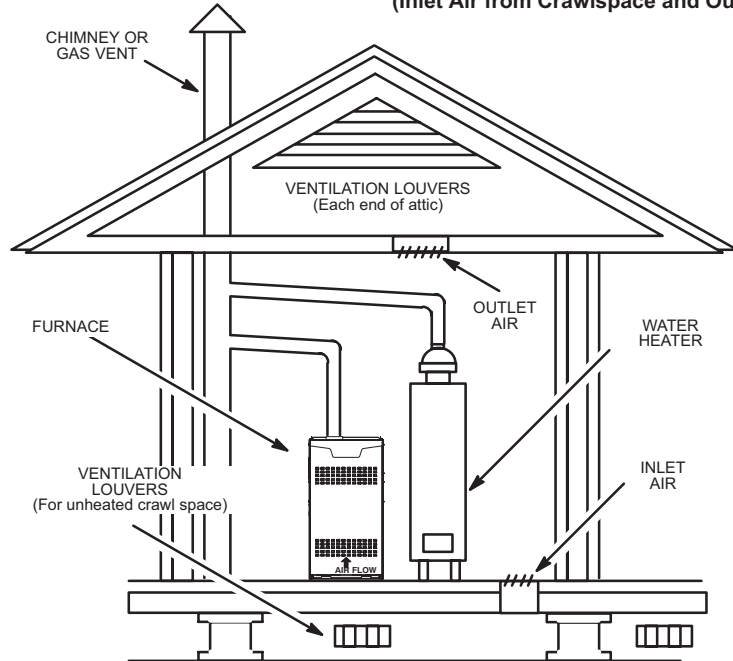

NOTE-The inlet and outlet air openings shall each have a free area of at least one square inch (645 mm²) per 4,000 Btu (1.17 kW) per hour of the total input rating of all equipment in the enclosure.

FIGURE 3

**EQUIPMENT IN CONFINED SPACE
ALL AIR FROM OUTSIDE
(All Air Through Ventiladed Attic)**

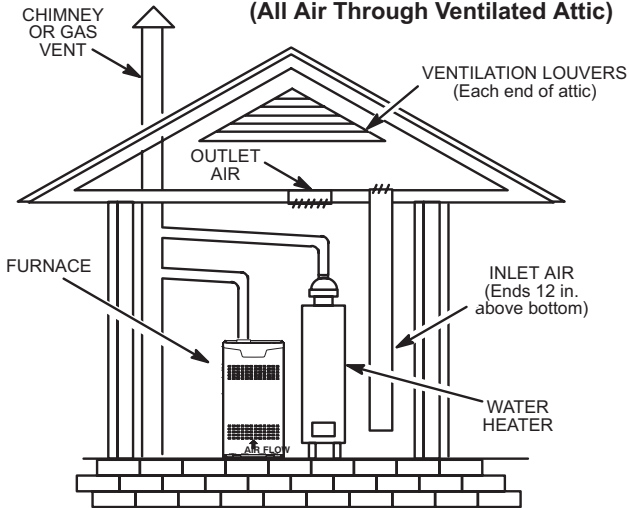

NOTE-The inlet and outlet air openings shall each have a free area of at least one square inch (645 mm²) per 4,000 Btu (1.17 kW) per hour of the total input rating of all equipment in the enclosure.

FIGURE 4

**EQUIPMENT IN CONFINED SPACE
ALL AIR FROM OUTSIDE**

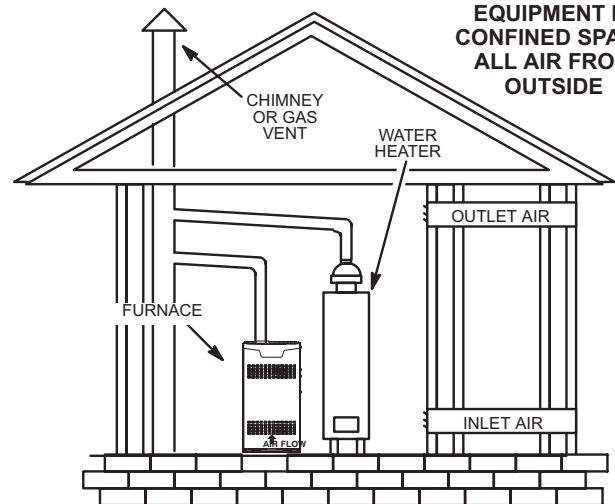

NOTE - Each air duct opening shall have a free area of at least one square inch (645 mm²) per 2,000 Btu (.59 kW) per hour of the total input rating of all equipment in the enclosure. If the equipment room is located against an outside wall and the air openings communicate directly with the outdoors, each opening shall have a free area of at least one square inch (645 mm²) per 4,000 Btu (1.17 kW) per hour of the total input rating of all other equipment in the enclosure.

FIGURE 5

Downflow Installation

Downflow unit installs in three ways: on non-combustible flooring, on combustible flooring using a downflow combustible flooring base, or on a reverse-flow cooling cabinet. Do not drag the unit across the floor.

Installation on Non-Combustible Flooring (FIGURE 6)

- 1 - Cut floor opening keeping in mind clearances listed on unit rating plate. Also keep in mind gas supply connections, electrical supply, flue and air intake connections and sufficient installation and servicing clearances. See TABLE 1 for correct floor opening size.
- 2 - Flange warm air plenum and lower the plenum into the opening.
- 3 - Set the unit over the plenum and seal the plenum to the unit.
- 4 - Ensure that the seal is adequate.

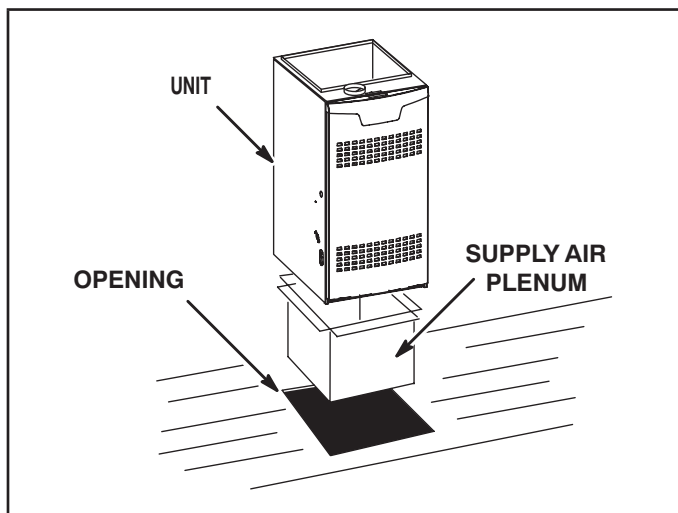

FIGURE 6

TABLE 1

NON-COMBUSTIBLE FLOOR OPENING SIZE

Cabinet Width	Front to Rear		Side to Side	
	in	mm	in	mm
A (14.5")	19-3/4	502	13-1/4	337
B (17.5")	19-3/4	502	16-1/4	413
C (21")	19-3/4	502	19-3/4	502

NOTE - Door opening dimensions listed are 1/4 inch (6 mm) larger than the unit opening. See unit dimensions on page 2.

Installation on Combustible Flooring (FIGURE 7)

- 1 - When unit is installed on a combustible floor, a downflow combustible flooring base must be installed between the furnace and the floor. The base must be ordered separately.

See TABLE 2 for opening size to cut in floor.

CAUTION

The furnace and downflow combustible flooring base shall not be installed directly on carpeting, tile, or other combustible material other than wood flooring.

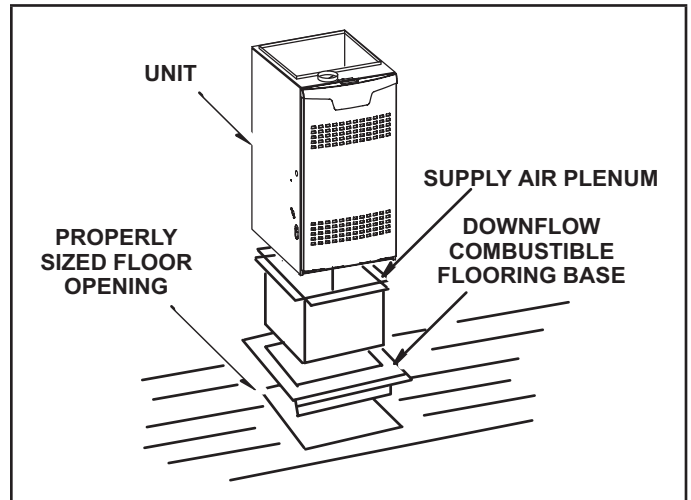

FIGURE 7

TABLE 2

COMBUSTIBLE FLOOR OPENING SIZE

Cabinet Width	Front to Rear		Side to Side	
	in	mm	in	mm
A (14.5")	2	559	15-3/4	400
B (17.5")	22	559	18-3/4	476
C (21")	22	559	22-3/4	578

NOTE - Floor opening dimensions listed are 1/4 inch (6 mm) larger than unit opening. See unit dimensions on page 2.

- 2 - After opening is cut, set combustible flooring base into opening.
- 3 - Check sealing strips on combustible flooring base to make sure they are properly glued and positioned.
- 4 - Lower supply air plenum into downflow combustible flooring base until plenum flanges seal against the strips.

NOTE - Be careful not to damage sealing strips. Check for a tight seal.

- 5 - Set the furnace over the plenum.
- 6 - Ensure that the seal between the furnace and plenum is adequate.

Installation on Cooling Cabinet (FIGURE 8)

- 1 - Refer to reverse-flow coil installation instructions for correctly sized opening in floor and installation of cabinet.

NOTE - Downflow combustible flooring kit is not used

- 2 - When cooling cabinet is in place, set and secure the furnace according to the instructions that are provided with the cooling coil. Secure the furnace to the cabinet.
- 3 - Seal the cabinet and check for air leaks.

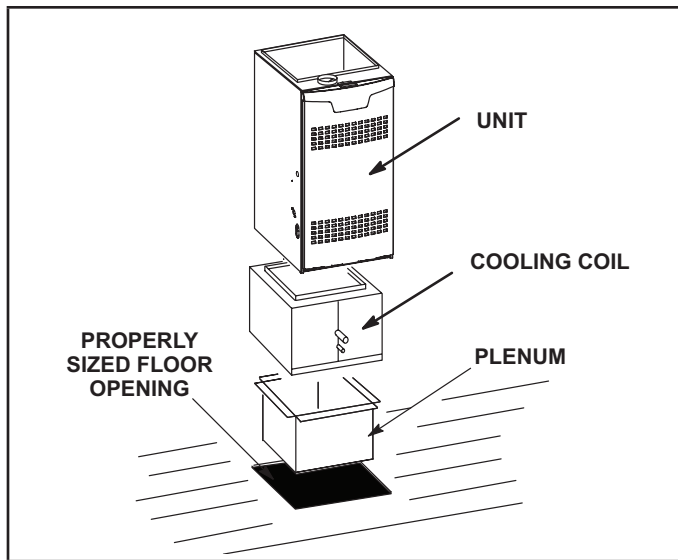

FIGURE 8

Return Air Opening -- Downflow Units

The following steps should be taken when installing plenum:

- 1 - Bottom edge of plenum should be flanged with a hemmed edge. See FIGURE 9.

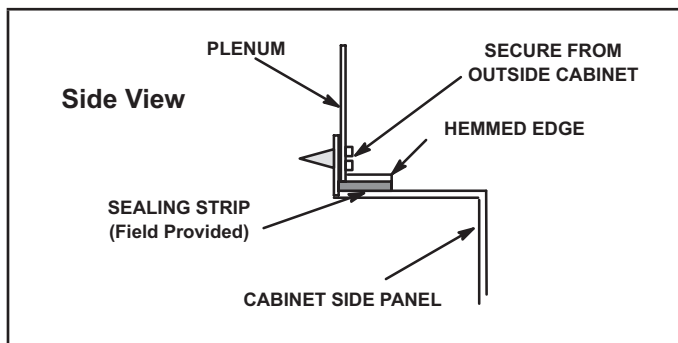

FIGURE 9

- 2 - Sealing strip should be used.
- 3 - In all cases, plenum should be secured to top flanges of furnace with sheet metal screws.

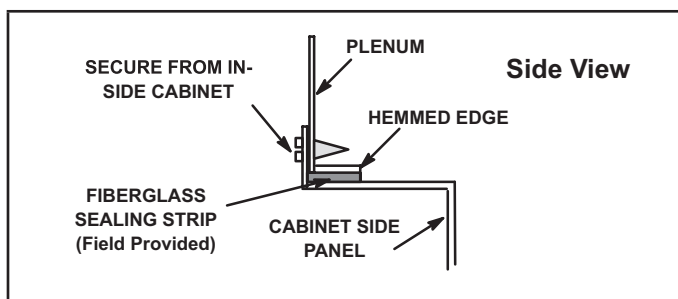

FIGURE 10

- 4 - In closet installations, it may be impossible to install sheet metal screws from the outside. In this case, make plenum with a removable front and install screws from the inside. See FIGURE 10.
- 5 - Make certain that an adequate seal is made.

Setting Equipment

⚠ WARNING

Do not install the furnace on its front, back or in the horizontal position. See FIGURE 12. Do not connect the return air ducts to the back of the furnace. Doing so will adversely affect the operation of the safety control devices, which could result in personal injury or death.

Install the SL280DFV gas furnace as shipped in the downflow position only. **Do not install the furnace horizontally.**

Select a location that allows for the required clearances that are listed on the unit nameplate. Also consider gas supply connections, electrical supply, vent connection, and installation and service clearances [24 inches (610 mm) at unit front]. The unit must be level.

NOTE - Units with 1/2 hp blower motors are equipped with three flexible legs and one rigid leg. See FIGURE 11. The rigid leg is equipped with a shipping bolt and a flat white plastic washer (rather than the rubber mounting grommet used with a flexible mounting leg). The bolt and washer must be removed before the furnace is placed into operation. After the bolt and washer have been removed, the rigid leg will not touch the blower housing.

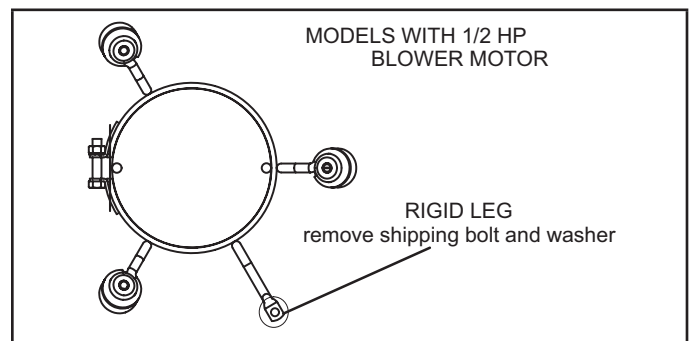

FIGURE 11

⚠ WARNING

The blower access panel must be securely in place when the blower and burners are operating. Gas fumes, which could contain carbon monoxide, can be drawn into living space resulting in personal injury or death.

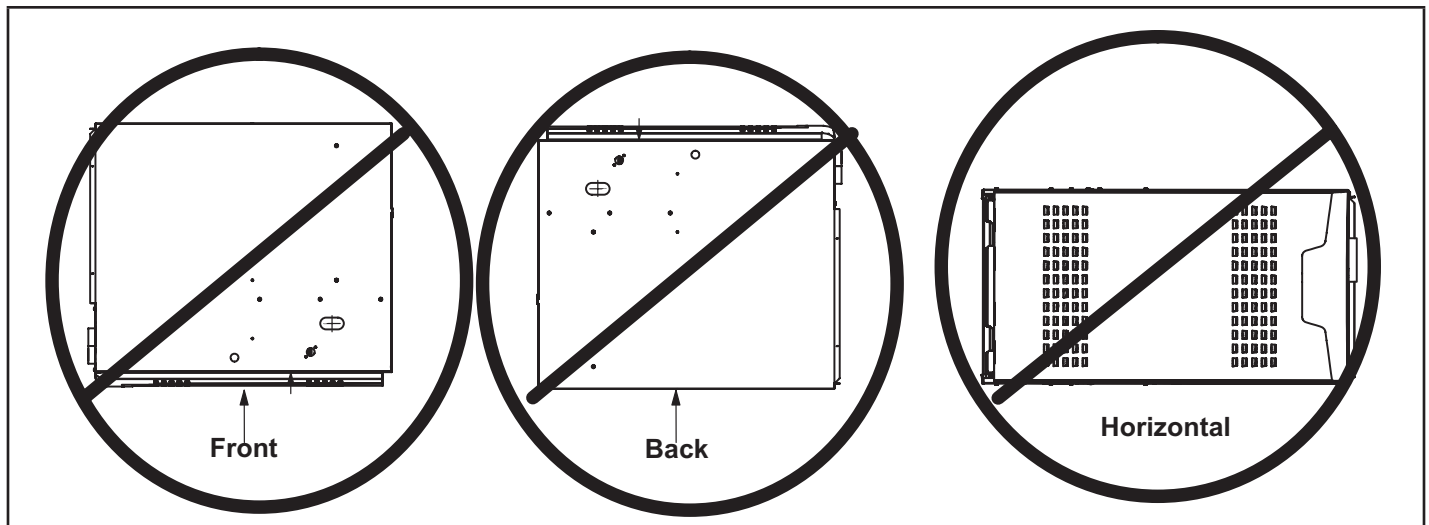

FIGURE 12

Downflow Application

Allow for clearances to combustible materials as indicated on the unit nameplate. Minimum clearances for closet or alcove installations are shown in FIGURE 13.

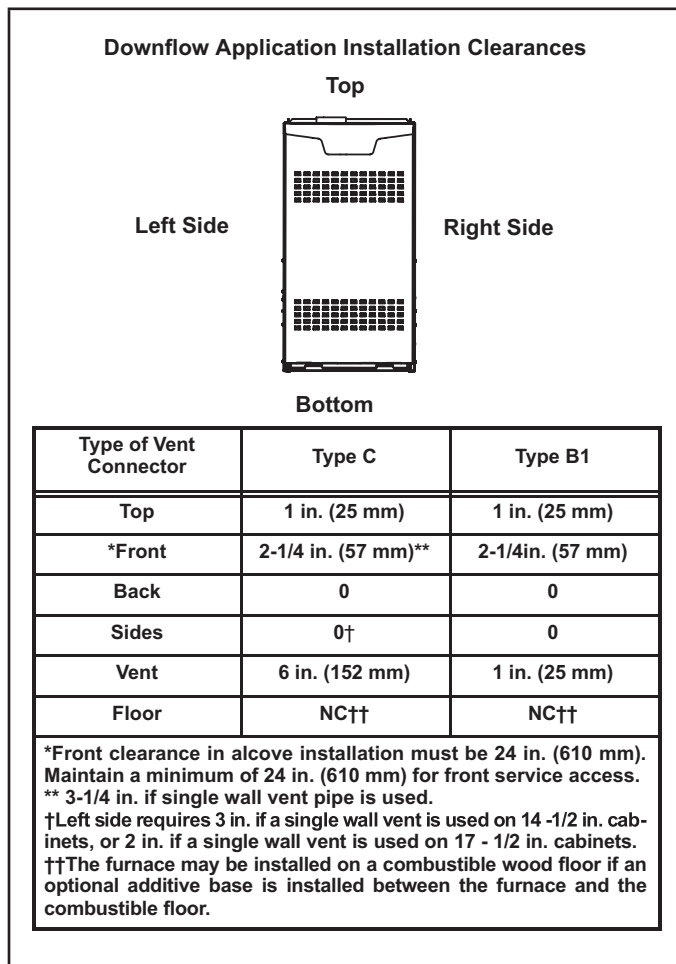

FIGURE 13

⚠ CAUTION

If this unit is being installed in a space serviced by an exhaust fan, power exhaust fan, or other device which may create a negative pressure in the space, take care when sizing the inlet air opening. The inlet air opening must be sized to accommodate the maximum volume of exhausted air as well as the maximum volume of combustion air required for all gas appliances serviced by this space.

⚠ WARNING

Improper installation of the furnace can result in personal injury or death. Combustion and flue products must never be allowed to enter the return air system or the living space. Use screws and joint tape to seal the return air system to the furnace. In platform installations with bottom return air, the furnace should be sealed airtight to the return air plenum.

A door must never be used as a portion of the return air duct system. The base must provide a stable support and an airtight seal to the furnace. Allow absolutely no sagging, cracks, gaps, etc. The return and supply air duct systems must never be connected to or from other heating devices such as a fireplace or stove, etc. Fire, explosion, carbon monoxide poisoning, personal injury and/or property damage could result. |

Filters

This unit is not equipped with a filter or rack. A field-provided high-velocity filter is required for the unit to operate properly. TABLE 3 lists recommended filter sizes. A filter must be in place any time the unit is operating.

IMPORTANT

If a highefficiency filter is being installed as part of this system to ensure better indoor air quality, the filter must be properly sized. Highefficiency filters have a higher static pressure drop than standardefficiency glass/foam filters. If the pressure drop is too great, system capacity and performance may be reduced.

The pressure drop may also cause the limit to trip more frequently during the winter and the indoor coil to freeze in the summer, resulting in an increase in the number of service calls. Before using any filter with this system, check the specifications provided by the filter manufacturer against the data given in the appropriate Lennox Product Specifications bulletin. Additional information is provided in Service and Application Note ACC002 (August 2000).

TABLE 3

Cabinet Width	Return Air Filter Size (inches)
A (14-1/2")	14 x 25 x 1 (1)
B (17-1/2")C	16 x 25 x 1 (1)
C (21")	20 x 25 x 1 (1)

Duct System / Venting

Use industry-approved standards (such as those published by Air Conditioning Contractors of America or American Society of Heating, Refrigerating and Air Conditioning Engineers) to size and install the supply and return air duct system. This will result in a quiet and low-static system that has uniform air distribution.

NOTE - Do not operate the furnace in the heating mode with an external static pressure that exceeds 0.8 inches w.c. Higher external static pressures may cause erratic limit operation.

Ensure that you have made a seal between the supply air plenum and the furnace and between the furnace and the return air plenum.

Return Air Plenum

Return air must not be drawn from a room where this furnace, or any other gas-fueled appliance (i.e., water heater), or carbon monoxide-producing device (i.e., wood fireplace) is installed. When return air is drawn from a room, a negative pressure is created in the room. If a gas appliance is operating in a room with negative pressure, the flue products can be pulled back down the vent pipe and into the room. This reverse flow of the flue gas may result in incomplete combustion and the formation of carbon monoxide gas. This toxic gas might then be distributed throughout the house by the furnace duct system.

Venting

A 4-inch diameter flue transition is factory-installed on all models. Modifying or removing the flue transition will cause the unit to operate unsafely and will void the unit certification. The vent connector does not require insulation.

The SL280DFV series units are classified as fan-assisted Category I furnaces when vertically vented according to the latest edition of National Fuel Gas Code (NFPA 54 / ANSI Z223.1). A fan-assisted Category I furnace is an appliance equipped with an integral mechanical means to either draw or force combustion products through the combustion chamber and/or heat exchanger.

NOTE - Use these instructions as a guide. They do not supersede local codes. This furnace must be vented according to all local codes, these installation instructions, and the provided venting tables in these instructions.

The venting tables in this manual were extracted from the National Fuel Gas Code (NFPA 54 / ANSI Z223.1) and are provided as a guide for proper vent installation. Proper application, termination, construction and location of vents must conform to local codes having jurisdiction. In the absence of local codes, the NFGC serves as the defining document.

Refer to the tables and the venting information contained in these instructions to properly size and install the venting system.

IMPORTANT

Once the venting system is installed, attach the "Disconnected Vent" warning sticker to a visible area of the plenum near the vent pipe. The warning sticker is provided in the bag assembly. Order kit 66W04 for additional stickers.

WARNING

Asphyxiation hazard. The exhaust vent for this furnace must be securely connected to the furnace flue transition at all times.

Use self-drilling sheet metal screws or a mechanical fastener to firmly secure the vent pipe to the round collar of the flue transition. If self-drilling screws are used to attach the vent pipe, it is recommended that three be used. Drive one self-drilling screw through the front and one through each side of the vent pipe and collar. See FIGURE 15.

Masonry chimneys used to vent Category I central furnaces must be either tile-lined or lined with a listed metal lining system or dedicated gas vent. Unlined masonry chimneys are prohibited. See FIGURE 14 and FIGURE 16 for common venting.

Common Venting Using Tile-Lined Interior Masonry Chimney and Combined Vent Connector

NOTE- Refer to provided venting tables for installations.

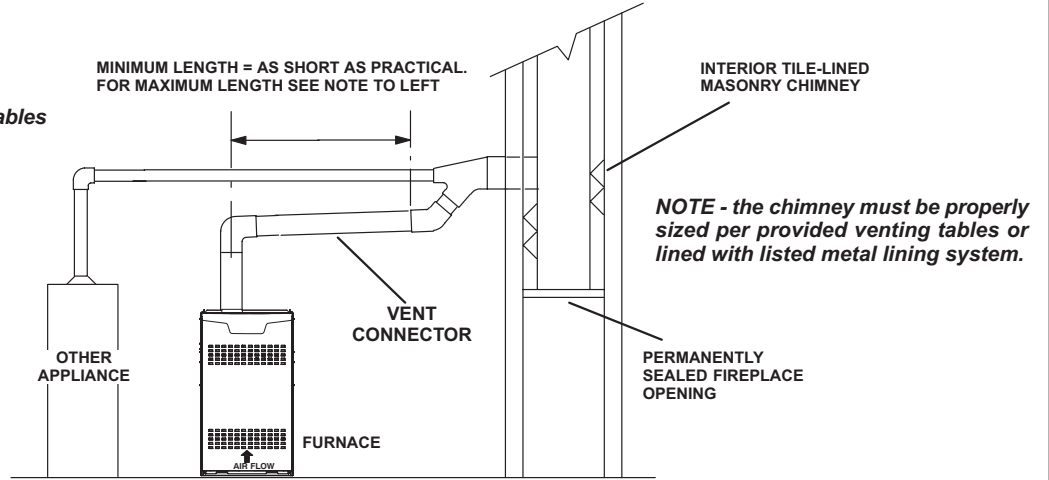

FIGURE 14

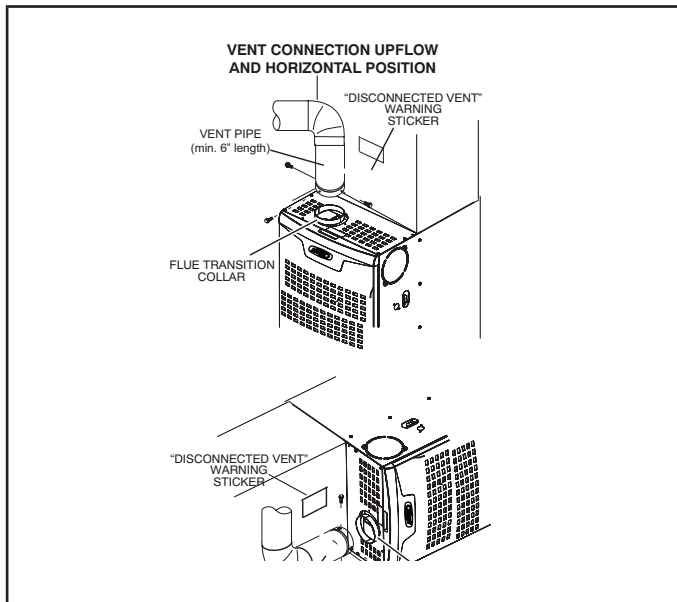

FIGURE 15

Venting Using a Masonry Chimney

The following additional requirements apply when a lined masonry chimney is used to vent this furnace.

A chimney with one or more sides exposed to the outside of the structure is considered to be an exterior chimney.

An exterior masonry chimney that is not tile-lined must be lined with B1 vent or a listed insulated flexible metal vent.

An exterior tile-lined chimney that is sealed and capped may be lined with a listed uninsulated flexible metal vent.

If the existing chimney will not accommodate a listed metal liner, either the chimney must be rebuilt to accommodate one of these liners or an alternate approved venting method must be found. Insulation for the flexible vent pipe must be an encapsulated fiberglass sleeve recommended by the flexible vent pipe manufacturer. See FIGURE 16.

Common Venting Using Metal-Lined Masonry Chimney

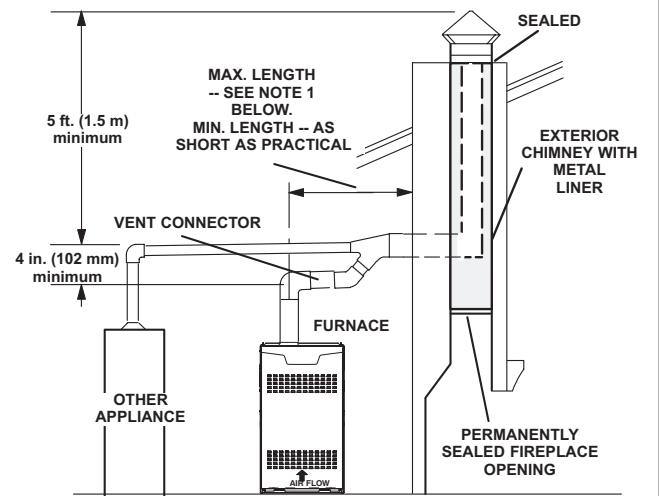

NOTE 1 - Refer to the provided venting tables for installations. Refer to the capacity requirements shown in the provided venting tables.

FIGURE 16

DO NOT insulate the space between the liner and the chimney wall with puffed mica or any other loose granular insulating material

! IMPORTANT

SINGLE appliance venting of a fan-assisted furnace into a tile-lined masonry chimney (interior or outside wall) is **PROHIBITED**. The chimney must first be lined with either type B1 vent or an insulated single wall flexible vent lining system which has been sized according to the provided venting tables and the vent pipe manufacturer's instructions.

A fan-assisted furnace may be commonly vented into an existing lined masonry chimney if the following conditions are met:

- The chimney is currently serving at least one draft-hood equipped appliance
- The vent connectors and chimney are sized according to the provided venting tables.

If type B1 double-wall vent is used inside a chimney, no other appliance can be vented into the chimney. The outer wall of type B1 vent pipe must not be exposed to flue products. A type B1 vent or masonry chimney liner shall terminate above the roof surface with a listed cap or a listed roof assembly according to the terms of their respective listings and the vent manufacturer's instructions.

When inspection reveals that an existing chimney is not safe for the intended purpose, it shall be rebuilt to conform to nationally recognized standards, lined or relined with suitable materials, or replaced with a gas vent or chimney suitable for venting SL280DFV series units. The chimney passageway must be checked periodically to ensure that it is clear and free of obstructions.

Do not install a manual damper, barometric draft regulator, or flue restrictor between the furnace and the chimney. Never connect a Category I appliance to a chimney that is servicing a solid-fuel appliance. If a fireplace chimney flue is used to vent this appliance, the fireplace opening must be permanently sealed.

A type B or listed chimney lining system that passes through an unused masonry chimney flue is not considered to be exposed to the outdoors.

General Venting Requirements

Vent all SL280DFV furnaces according to these instructions:

- 1 - Vent diameter recommendations and maximum allowable piping runs are found in the provided venting tables.
- 2 - In no case should the vent or vent connector diameter be less than the diameter specified in the provided venting tables.
- 3 - The minimum vent capacity determined by the sizing tables must be less than the low fire input rating and the maximum vent capacity must be greater than the high fire input rating.
- 4 - Single appliance vents - If the vertical vent or tile-lined chimney has a larger diameter or flow area than the vent connector, use the vertical vent diameter to determine the minimum vent capacity and the vent connector diameter to determine the maximum vent capacity. The flow area of the vertical vent, however, shall not exceed 7 times the flow area of the listed appliance categorized vent area, draft-hood outlet area or flue collar area unless designed according to approved engineering methods.
- 5 - Appliance vents - The flow area of the largest section of vertical vent or chimney shall not exceed 7 times the smallest listed appliance categorized vent area, draft-hood outlet area or flue collar area unless designed according to approved engineering methods.

- 6 - The entire length of single wall metal vent connector shall be readily accessible for inspection, cleaning, and replacement.
- 7 - Single appliance venting configurations with zero lateral lengths (TABLE 5) are assumed to have no elbows in the vent system. For all other vent configurations, the vent system is assumed to have two 90° elbows. For each additional 90° elbow or equivalent (for example two 45° elbows equal one 90° elbow) beyond two, the maximum capacity listed in the venting table should be reduced by 10% (0.90 x maximum listed capacity).
- 8 - The common venting tables (TABLE 6 and TABLE 7) were generated using a maximum horizontal vent connector length of 1-1/2 feet (.46 m) for each inch (25 mm) of connector diameter as follows:

TABLE 4

Connector Diameter inches	Maximum Horizontal Connector Length feet
3	4-1/2
4	6
5	7-1/2
6	9
7	10-1/2

- 9 - If the common vertical vent is offset, the maximum common vent capacity listed in the common venting tables should be reduced by 20%, the equivalent of two 90° elbows (0.80 x maximum common vent capacity). The horizontal length of the offset shall not exceed 1-1/2 feet (.46 m) for each inch (25 mm) of common vent diameter.
- 10 - The vent pipe should be as short as possible with the least number of elbows and angles required to complete the job. Route the vent connector to the vent using the shortest possible route.
- 11 - A vent connector shall be supported without any dips or sags and shall slope a minimum of 1/4 inch (6.4 mm) per linear foot (305 mm) of connector, back toward the appliance.
- 12 - Vent connectors shall be firmly attached to the furnace flue collar by self-drilling screws or other approved means, except vent connectors of listed type B vent material which shall be assembled according to the manufacturer's instructions. Joints between sections of single wall connector piping shall be fastened by screws or other approved means.
- 13 - When the vent connector used for Category I appliances must be located in or pass through a crawlspace or other areas which may be cold, that portion of the vent connector shall be constructed of listed double-wall type B vent material or material having equivalent insulation qualities.

- 14 - All venting pipe passing through floors, walls, and ceilings must be installed with the listed clearance to combustible materials and be fire stopped according to local codes. In absence of local codes, refer to NFGC (Z223.1).
- 15 - No portion of the venting system can extend into, or pass through any circulation air duct or plenum.
- 16 - Vent connectors serving Category I appliances shall not be connected to any portion of mechanical draft systems operating under positive pressure such as Category III or IV venting systems.
- 17 - If vent connectors are combined prior to entering the common vent, the maximum common vent capacity listed in the common venting tables must be reduced by 10%, the equivalent of one 90° elbow (0.90 x maximum common vent capacity).
- 18 - The common vent diameter must always be at least as large as the largest vent connector diameter.
- 19 - In no case, shall the vent connector be sized more than two consecutive table size diameters over the size of the draft hood outlet or flue collar outlet.
- 20 - Do not install a manual damper, barometric draft regulator or flue restrictor between the furnace and the chimney.
- 21 - When connecting this appliance to an existing dedicated or common venting system, you must inspect the venting system's general condition and look for signs of corrosion. The existing vent pipe size must conform to these instructions and the provided venting tables. If the existing venting system does

TABLE 5
Capacity of Type B Double-Wall Vents with Type B Double-Wall Connectors
Serving a Single Category I Appliance

Height H (feet)	Lateral L (feet)	Vent and Connector Diameter - D (inches)							
		3 inch		4 inch		5 inch		6 inch	
		Appliance Input Rating in Thousands of Btu Per Hour							
		Min	Max	Min	Max	Min	Max	Min	Max
6	0	0	78	0	152	0	251	0	375
	2	13	51	18	97	27	157	32	232
	4	21	49	30	94	39	153	50	227
	6	25	46	36	91	47	149	59	223
8	0	0	84	0	165	0	276	0	415
	2	12	57	16	109	25	178	28	263
	5	23	53	32	103	42	171	53	255
	8	28	49	39	98	51	164	64	247
10	0	0	88	0	175	0	295	0	447
	2	12	61	17	118	23	194	26	289
	5	23	57	32	113	41	187	52	280
	10	30	51	41	104	54	176	67	267
15	0	0	94	0	191	0	327	0	502
	2	11	69	15	136	20	226	22	339
	5	22	65	30	130	39	219	49	330
	10	29	59	40	121	51	206	64	315
	15	35	53	48	112	61	195	76	301
20	0	0	97	0	202	0	349	0	540
	2	10	75	14	149	18	250	20	377
	5	21	71	29	143	38	242	47	367
	10	28	64	38	133	50	229	62	351
	15	34	58	46	124	59	217	73	337
	20	48	52	55	116	69	206	84	322
30	0	0	100	0	213	0	374	0	587
	2	9	81	13	166	14	283	18	432
	5	21	77	28	160	36	275	45	421
	10	27	70	37	150	48	262	59	405
	15	33	64	44	141	57	249	70	389
	20	56	58	53	132	66	237	80	374
	30	NA	NA	73	113	88	214	104	346

NOTE - Single appliance venting configurations with zero lateral lengths are assumed to have no elbows in the vent system. For all other vent configurations, the vent system is assumed to have two 90° elbows. For each additional 90° elbow or equivalent (for example two 45° elbows equal one 90° elbow) beyond two, the maximum capacity listed in the venting table should be reduced by 10 percent (0.90 x maximum listed capacity).

TABLE 6

Vent Connector Capacity
 Type B Double-Wall Vents with Type B Double-Wall Connectors
 Serving Two or More Category I Appliances

Height H (feet)	Lateral L (feet)	Vent and Connector Diameter - D (inches)							
		3 inch		4 inch		5 inch		6 inch	
		Appliance Input Rating in Thousands of Btu Per Hour							
		Min	Max	Min	Max	Min	Max	Min	Max
6	1	22	37	35	66	46	106	58	164
	2	23	41	37	75	48	121	60	183
	3	24	44	38	81	49	132	62	199
8	1	22	40	35	72	49	114	64	176
	2	23	44	36	80	51	128	66	195
	3	24	47	37	87	53	139	67	210
10	1	22	43	34	78	49	123	65	189
	2	23	47	36	86	51	136	67	206
	3	24	50	37	92	52	146	69	220
15	1	21	50	33	89	47	142	64	220
	2	22	53	35	96	49	153	66	235
	3	24	55	36	102	51	163	68	248
20	1	21	54	33	99	46	157	62	246
	2	2	57	34	105	48	167	64	259
	3	23	60	35	110	50	176	66	271
30	1	20	62	31	113	45	181	60	288
	2	21	64	33	118	47	190	62	299
	3	22	66	34	123	48	198	64	309

TABLE 7

Common Vent Capacity
 Type B Double-Wall Vents with Type B Double-Wall Connectors
 Serving Two or More Category I Appliances

Vent Height H (feet)	Vent and Connector Diameter - D (inches)							
	4 inch		5 inch		7 inch		7 inch	
	Appliance Input Rating in Thousands of Btu Per Hour							
	FAN + FAN	FAN + NAT	FAN + FAN	FAN + NAT	FAN + FAN	FAN + NAT	FAN + FAN	FAN + NAT
6	92	81	140	116	204	161	309	248
8	101	90	155	129	224	178	339	275
10	110	97	169	141	243	194	367	299
15	125	112	195	164	283	228	427	352
20	136	123	215	183	314	255	475	394
30	152	138	244	210	361	297	547	459

Removal of the Furnace from Common Vent

In the event that an existing furnace is removed from a venting system commonly run with separate gas appliances, the venting system is likely to be too large to properly vent the remaining attached appliances.

Conduct the following test while each appliance is operating and the other appliances (which are not operating) remain connected to the common venting system. If the venting system has been installed improperly, you must correct the system as indicated in the general venting requirements section.

WARNING

CARBON MONOXIDE POISONING HAZARD

Failure to follow the steps outlined below for each appliance connected to the venting system being placed into operation could result in carbon monoxide poisoning or death.

The following steps shall be followed for each appliance connected to the venting system being placed into operation, while all other appliances connected to the venting system are not in operation:

- 1 - Seal any unused openings in the common venting system.
- 2 - Inspect the venting system for proper size and horizontal pitch. Determine that there is no blockage, restriction, leakage, corrosion, or other deficiencies which could cause an unsafe condition.
- 3 - Close all building doors and windows and all doors between the space in which the appliances remaining connected to the common venting system are located and other spaces of the building. Turn on clothes dryers and any appliances not connected to the common venting system. Turn on any exhaust fans, such as range hoods and bathroom exhausts, so they will operate at maximum speed. Do not operate a summer exhaust fan. Close fireplace dampers.
- 4 - Follow the lighting instructions. Turn on the appliance that is being inspected. Adjust the thermostat so that the appliance operates continuously.
- 5 - After the main burner has operated for 5 minutes, test for leaks of flue gases at the draft hood relief opening. Use the flame of a match or candle, or smoke from a cigarette, cigar, or pipe.
- 6 - After determining that each appliance connected to the common venting system is venting properly, (step 3) return all doors, windows, exhaust fans, fireplace dampers, and any other gas-burning appliances to their previous mode of operation.
- 7 - If a venting problem is found during any of the preceding tests, the common venting system must be modified to correct the problem.

Resize the common venting system to the minimum vent pipe size determined by using the appropriate tables in Appendix G. (These are in the current standards of the National Fuel Gas Code ANSI Z223.1.

Gas Piping

CAUTION

If a flexible gas connector is required or allowed by the authority that has jurisdiction, black iron pipe shall be installed at the gas valve and extend outside the furnace cabinet. The flexible connector can then be added between the black iron pipe and the gas supply line.

Gas Supply

WARNING

Do not over torque (800 in-lbs) or under torque (350 in-lbs) when attaching the gas piping to the gas valve.

- 1 - This unit is shipped standard for left or right side installation of gas piping. Connect the gas supply piping into the gas valve. The maximum torque is 800 in lbs and minimum torque is 350 in lbs when attaching the gas piping to the gas valve.
- 2 - When connecting the gas supply piping, consider factors such as length of run, number of fittings, and furnace rating to avoid excessive pressure drop. TABLE 8 lists recommended pipe sizes for typical applications.
- 3 - The gas piping must not run in or through air ducts, clothes chutes, gas vents or chimneys, dumb waiters, or elevator shafts.
- 4 - The piping should be sloped 1/4 inch (6.4 mm) per 15 feet (4.57 m) upward toward the meter from the furnace. The piping must be supported at proper intervals [every 8 to 10 feet (2.44 to 3.01 m)] with suitable hangers or straps. Install a drip leg inside vertical pipe runs to the unit.
- 5 - A 1/8" N.P.T. plugged tap or pressure post is located on the gas valve to facilitate test gauge connection. See FIGURE 24.
- 6 - In some localities, codes may require the installation of a manual main shut-off valve and union (furnished by the installer) external to the unit. The union must be of the ground joint type.

IMPORTANT

Compounds used on threaded joints of gas piping must be resistant to the actions of liquified petroleum gases.

TABLE 8
Gas Pipe Capacity - ft³/hr (m³/hr)

Nominal Iron Pipe Size Inches (mm)	Internal Diameter inches (mm)	Length of Pipe - feet (m)									
		10 (3.048)	20 (6.096)	30 (9.144)	40 (12.192)	50 (15.240)	60 (18.288)	70 (21.336)	80 (24.384)	90 (27.432)	100 (30.480)
1/2 (12.7)	.622 (17.799)	172 (4.87)	118 (3.34)	95 (2.69)	81 (2.29)	72 (2.03)	65 (1.84)	60 (1.69)	56 (1.58)	52 (1.47)	50 (1.42)
3/4 (19.05)	.824 (20.930)	360 (10.19)	247 (7.000)	199 (5.63)	170 (4.81)	151 (4.23)	137 (3.87)	126 (3.56)	117 (3.31)	110 (3.11)	104 (2.94)
1 (25.4)	1.049 (26.645)	678 (19.19)	466 (13.19)	374 (10.59)	320 (9.06)	284 (8.04)	257 (7.27)	237 (6.71)	220 (6.23)	207 (5.86)	195 (5.52)
1-1/4 (31.75)	1.380 (35.052)	1350 (38.22)	957 (27.09)	768 (22.25)	657 (18.60)	583 (16.50)	528 (14.95)	486 (13.76)	452 (12.79)	424 (12.00)	400 (11.33)
1-1/2 (38.1)	1.610 (40.894)	2090 (59.18)	1430 (40.49)	1150 (32.56)	985 (27.89)	873 (24.72)	791 (22.39)	728 (20.61)	677 (19.17)	635 (17.98)	600 (17.00)
2 (50.8)	2.067 (52.502)	4020 (113.83)	2760 (78.15)	2220 (62.86)	1900 (53.80)	1680 (47.57)	1520 (43.04)	1400 (39.64)	1300 (36.81)	1220 (34.55)	1160 (32.844)
2-1/2 (63.5)	2.469 (67.713)	6400 (181.22)	4400 (124.59)	3530 (99.95)	3020 (85.51)	2680 (75.88)	2480 (70.22)	2230 (63.14)	2080 (58.89)	1950 (55.22)	1840 (52.10)
3 (76.2)	3.068 (77.927)	11300 (319.98)	7780 (220.30)	6250 (176.98)	5350 (151.49)	4740 (134.22)	4290 (121.47)	3950 (111.85)	3670 (103.92)	3450 (97.69)	3260 (92.31)

NOTE - Capacity given in cubic feet (m³) of gas per hour and based on 0.60 specific gravity gas.

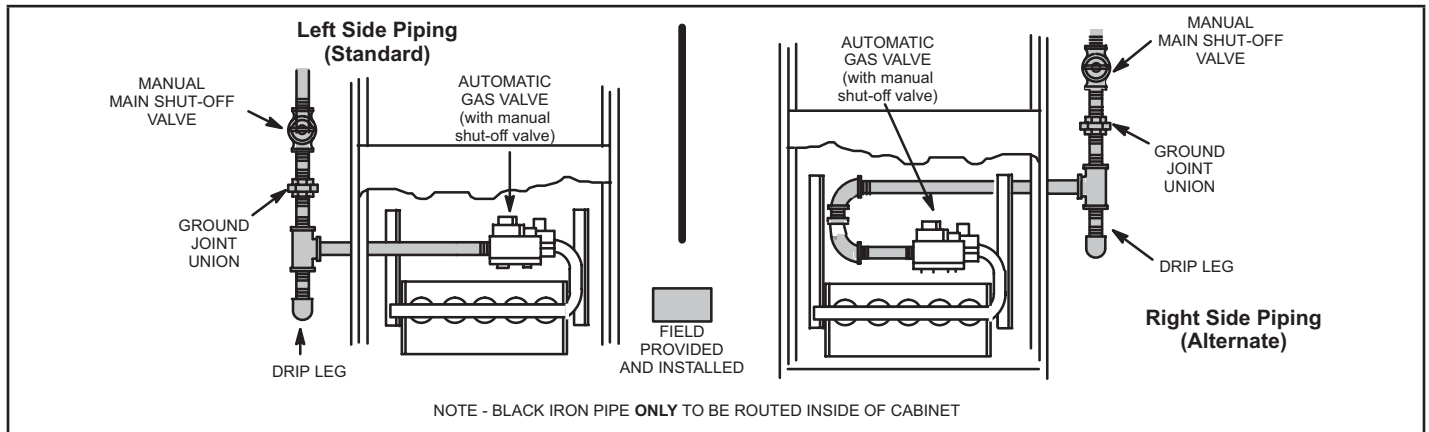

FIGURE 17

Leak Check

After gas piping is completed, carefully check all field-installed piping connections for gas leaks. Use a commercially available leak detecting solution specifically manufactured for leak detection. Never use an open flame to test for gas leaks.

NOTE - If emergency shutoff is necessary, shut off the main manual gas valve and disconnect the main power to the furnace. The installer should properly label these devices.

⚠ CAUTION

Some soaps used for leak detection are corrosive to certain metals. Carefully rinse piping thoroughly after leak test has been completed. Do not use matches, candles, flame or other sources of ignition to check for gas leaks.

The furnace must be isolated from the gas supply system by closing the individual manual shut-off valve during any gas supply system at pressures greater than or equal to 1/2 psig. (3.48 kPa, 14 inches w.c.). This furnace and its components are designed, manufactured and independently certified to comply with all applicable ANSI/CSA standards. A leak check of the furnace and its components is not required

⚠ IMPORTANT
When testing pressure of gas lines, gas valve must be disconnected and isolated. See FIGURE 18. Gas valves can be damaged if subjected to pressures greater than 1/2 psig (3.48 kPa, 14 inches w.c.).

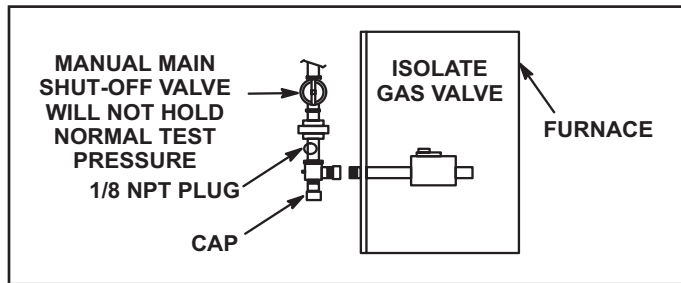

FIGURE 18

Electrical

**ELECTROSTATIC DISCHARGE (ESD)
Precautions and Procedures**

⚠ CAUTION
Electrostatic discharge can affect electronic components. Take precautions to neutralize electrostatic charge by touching your hand and tools to metal prior to handling the control.

⚠ WARNING
Electric Shock Hazard. Can cause injury or death. Unit must be properly grounded in accordance with national and local codes.

⚠ WARNING
Fire Hazard. Use of aluminum wire with this product may result in a fire, causing property damage, severe injury or death. Use copper wire only with this product.

⚠ CAUTION
Failure to use properly sized wiring and circuit breaker may result in property damage. Size wiring and circuit breaker(s) per Product Specifications bulletin (EHB) and unit rating plate.

The unit is equipped with a field make-up box on the left hand side of the cabinet. The make-up box may be moved to the right side of the furnace to facilitate installation. If the make-up box is moved to the right hand side, clip the wire ties that bundle the wires together. Secure the excess wire to the existing harness to protect it from damage.

See FIGURE 20 and FIGURE 21 for communicating applications. TABLE 10 shows DIP switch and on-board link settings for non-communicating thermostat applications. Typical wiring schematic is shown in FIGURE 22.

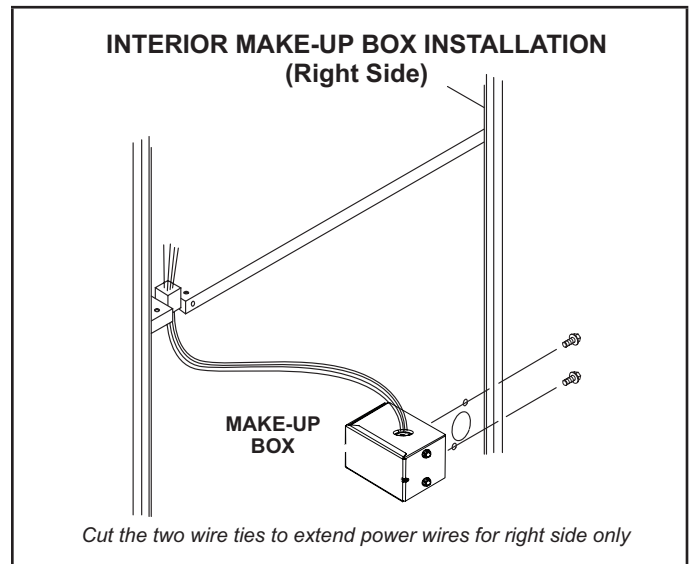

FIGURE 19

- 1 - The power supply wiring must meet Class I restrictions. Protected by either a fuse or circuit breaker, select circuit protection and wire size according to unit nameplate.

NOTE - Unit nameplate states maximum current draw. Maximum over-current protection allowed is shown in TABLE 9.

TABLE 9

SL280DF MODEL	Maximum Over-Current Protection (Amps)
070V36A	15
090V48B, 090V60C, 110V60C	20

- 2 - Holes are on both sides of the furnace cabinet to facilitate wiring.
- 3 - Install a separate (properly sized) disconnect switch near the furnace so that power can be turned off for servicing.
- 4 - Before connecting the thermostat or the power wiring, check to make sure the wires will be long enough for servicing at a later date. Remove the blower access panel to check the length of the wire
- 5 - Complete the wiring connections to the equipment. Use the provided unit wiring diagram and the field wiring diagrams shown in TABLE 10 and FIGURE 22. Use 18-gauge wire or larger that is suitable for Class II rating for thermostat connections.

- 6 - Electrically ground the unit according to local codes or, in the absence of local codes, according to the current National Electric Code (ANSI/NFPA No. 70). A green ground wire is provided in the field make-up box.

NOTE - The SL280DFV furnace contains electronic components that are polarity sensitive. Make sure that the furnace is wired correctly and is properly grounded.

- 7 - One line voltage "ACC" 1/4" spade terminal is provided on the furnace integrated control. Any electronic air cleaner or other accessory rated up to one amp can be connected to this terminal with the neutral leg of the circuit being connected to the one of the provided neutral terminals. See FIGURE 23 for control configuration. This terminal is energized when the indoor blower is operating.
- 8 - An unpowered, normally open (dry) set of contacts with a 1/4" spade terminal "HUM" are provided for humidifier connections and may be connected to 24V or 120V. Any humidifier rated up to one amp can be connected to these terminals. In 120V humidifier applications the neutral leg of the circuit can be connected to one of the provided neutral terminals. This terminal is energized in the heating mode.
- 9 - Install the room thermostat according to the instructions provided with the thermostat. See TABLE 10 for field wiring connections in varying applications. If the furnace is being matched with a heat pump, refer to the instruction packaged with the dual fuel thermostat.

Thermostat Selection

CAUTION

Field wiring for both communicating and non-communicating applications is illustrated in diagrams, which begin on Page 22.

Non-Communicating

In non-communicating applications the SL280DFV is designed to operate in a SINGLE-STAGE mode or TWOSTAGE mode using a conventional thermostat.

For optimal performance in non-communicating applications, Lennox recommends use of a ComfortSense® 7000 high quality electronic digital thermostat or any other with adjustable settings for 1st stage / 2nd stage on / off differentials and adjustable stage timers.

Lennox recommends the following two-stage thermostat settings:

First heat stage differential set to 1/2 to 1 degree F; second heat stage differential set to 1/2 or 1 degree F; second heat stage upstage timer disabled, or set to maximum (1 hr minimum).

Communicating

In communicating applications a communicating thermostat must be used. Refer to the instructions provided with the thermostat for installation, set-up and operation. In communicating system all unused thermostat wire in the wire bundle needs to be terminated inside and out. The extra wires can terminate on the "C" terminal of the communication terminal strip. (RSBus). Using an additional wire come off "C" terminal and wire nut all the extra wires together. Termination on the outdoor control must match the indoor control.

Indoor Blower Speeds

Non-Communicating

- 1 - When the thermostat is set to "FAN ON," the indoor blower will run continuously at a field selectable percentage of the second-stage cooling speed when there is no cooling or heating demand. The factory default setting is 38% of cool speed.
- 2 - When the SL280DFV is running in the heating mode, the indoor blower will run on the heating speed designated by the positions of DIP switches 11, 12 and 13. First stage heating will run at 91% heat speed.
- 3 - When there is a cooling demand, the indoor blower will run on the cooling speed designated by the positions of DIP switches 5 and 6. First stage cooling will run at 70% cool speed.

Communicating

NOTE - When the SL280DFV is used with a communicating thermostat, proper indoor blower speed selections are made by the thermostat.

- 1 - When the thermostat is set to "FAN ON," the indoor blower will run at setting determined during system configuration. See TABLE 25 on page 56 for allowable circulation speeds.
- 2 - When there is a heating demand the fan will run on heating speeds for firing rate.
- 3 - When there is a cooling demand, the fan will run on the first stage and second stage cooling speed set using the thermostat in the installer setup mode.

Generator Use - Voltage Requirements

The following requirements must be kept in mind when specifying a generator for use with this equipment:

- The furnace requires 120 volts (Range: 102 volts to 132 volts)
- The furnace operates at 60 Hz + 5% (Range: 57 Hz to 63 Hz)

- The furnace integrated control requires both correct polarity and proper ground. Both polarity and proper grounding should be checked before attempting to operate the furnace on either permanent or temporary power
- Generator should have a wave form distortion of less than 5% THD (total harmonic distortion)

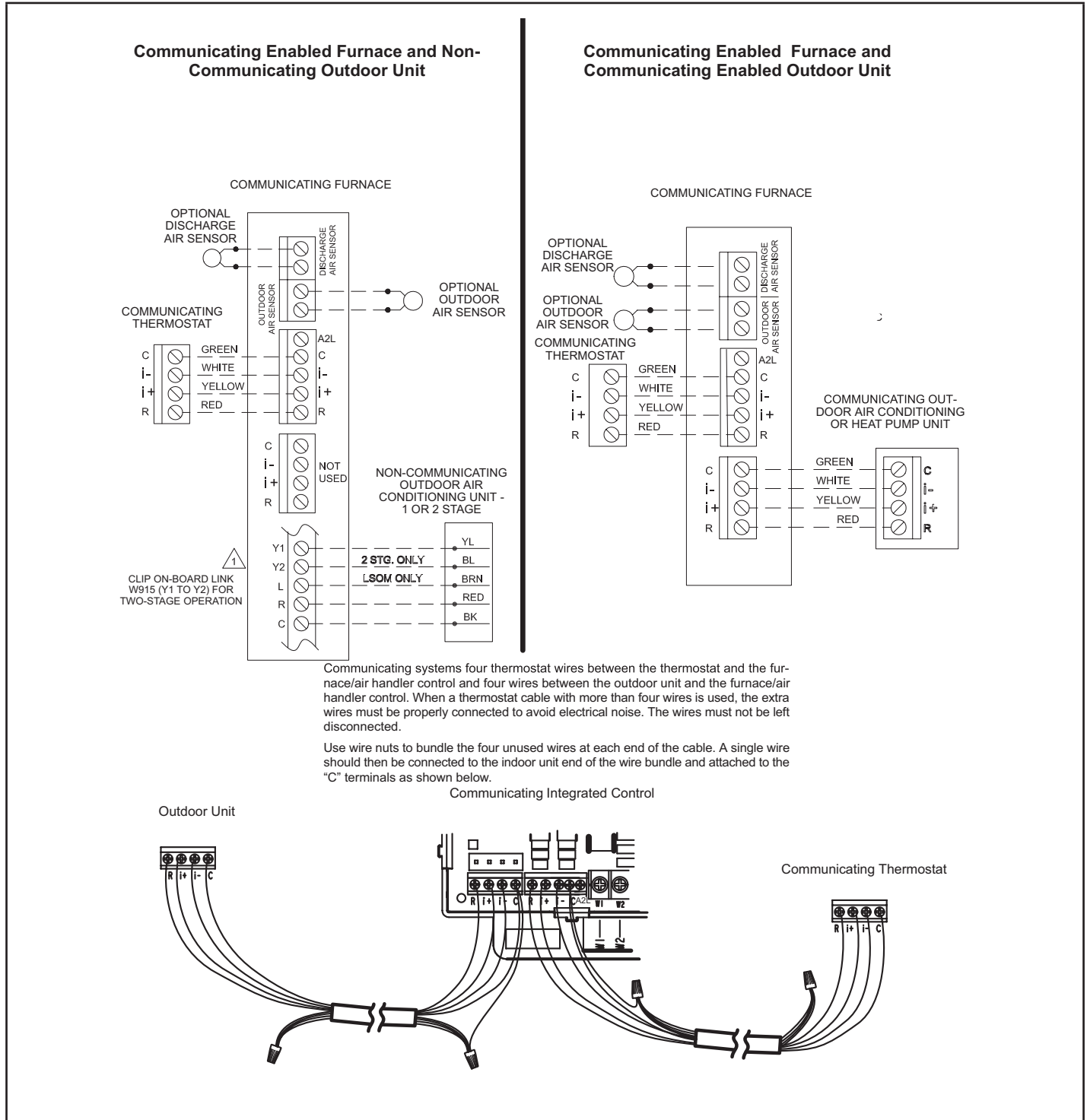

FIGURE 20

Optional Accessories for use with Communicating System

NOTE: COMMUNICATING THERMOSTAT SENSES HUMIDITY & CONTROLS HUM CONTACTS TO CYCLE HUMIDIFIER BASED ON DEMAND. NO OTHER CONTROL OR HUMIDISTAT REQUIRED.

OPTIONAL OUTDOOR AIR SENSOR FOR USE WITH HUMIDIFIER (IF NOT ALREADY IN THE SYSTEM FOR OTHER FUNCTIONS. BUILT INTO ALL COMMUNICATING ENABLED OUTDOOR UNITS).

120V CONNECTIONS

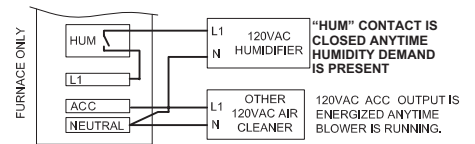

24V HUMIDIFIER CONNECTIONS

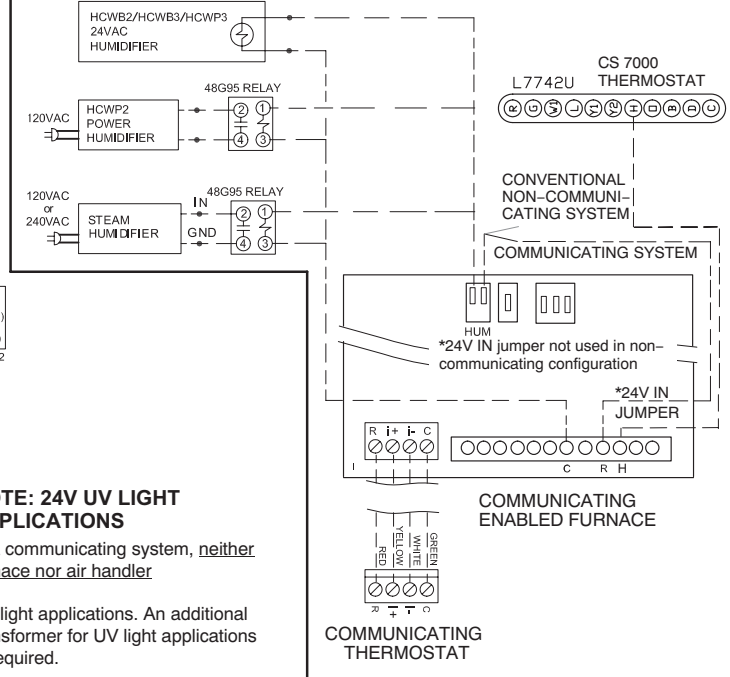

COMMUNICATING ENABLED FURNACE

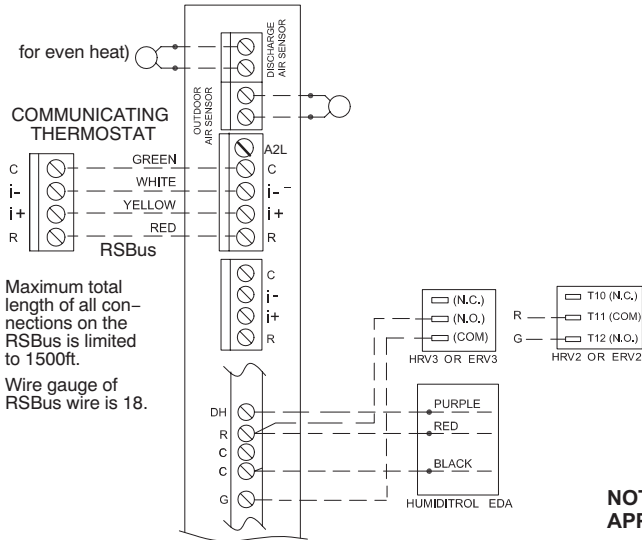

NOTE: 24V UV LIGHT APPLICATIONS

In a communicating system, neither furnace nor air handler

UV light applications. An additional transformer for UV light applications is required.

HEPA BYPASS FILTER X2680 HEPA INTERLOCK KIT

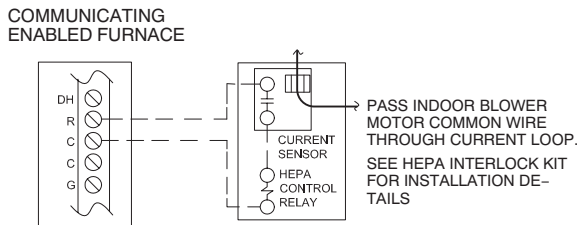

LVCS VENTILATION CONTROL SYSTEM

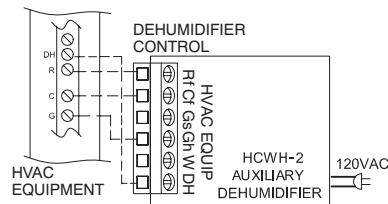
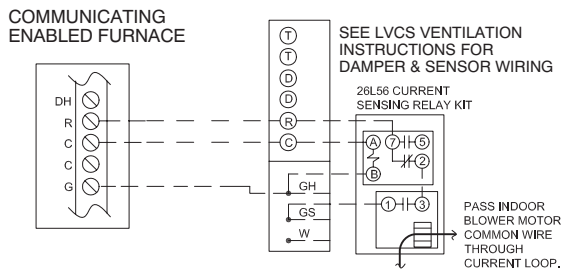

FIGURE 21

Optional Accessories With Communicating System

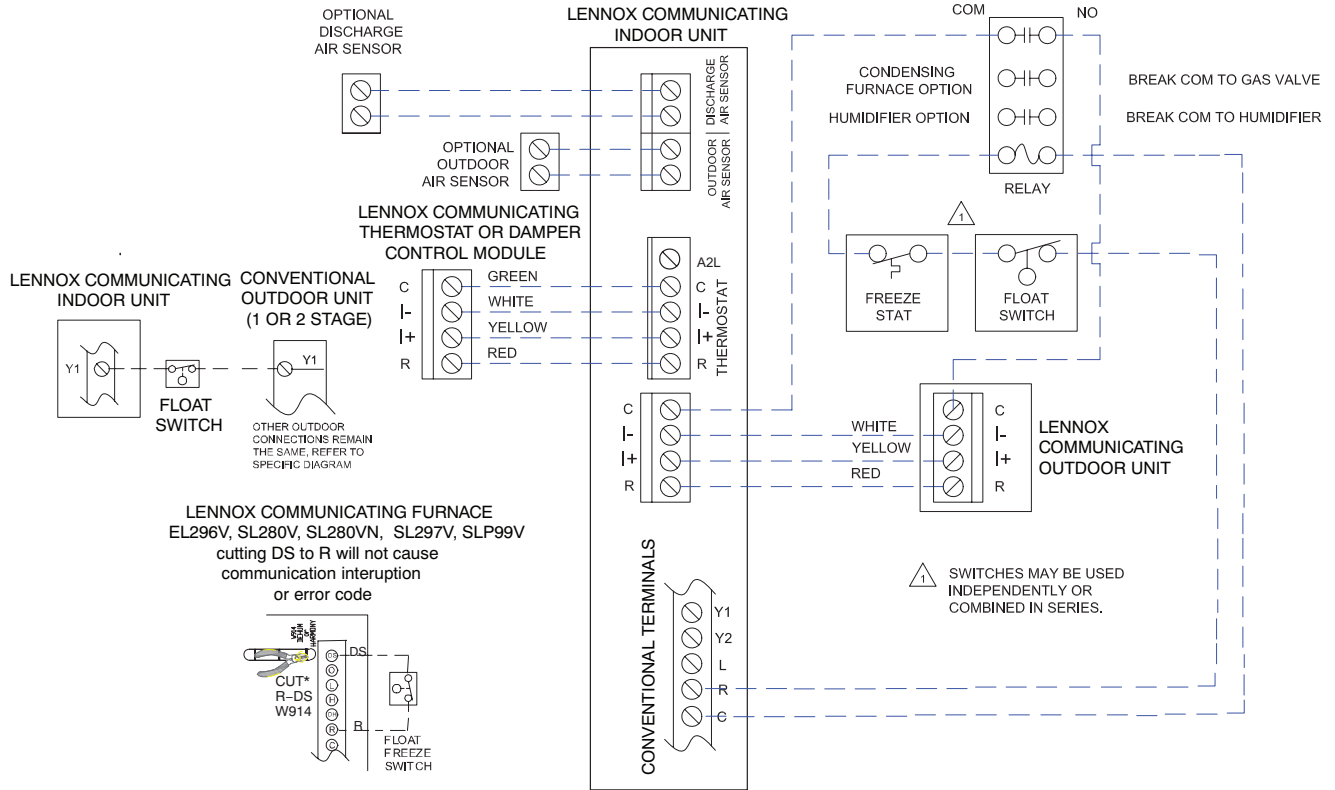
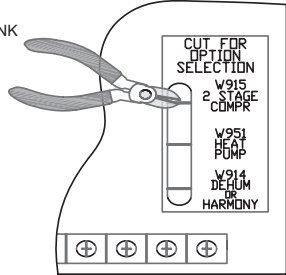
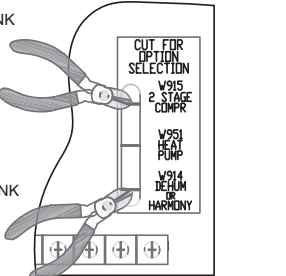
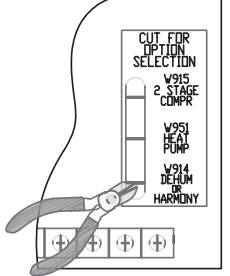
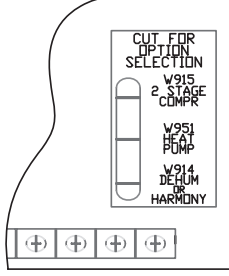

TABLE 10
SL280 Field Wiring Applications With Conventional Thermostat

Thermostat	DIP Switch Settings and On-Board Links		Wiring Connections																																				
	DIP Switch 1 Thermostat Heating Stages	On Board Links Must Be Cut To Select System Options																																					
1 Heat / 1 Cool <i>NOTE - Use DIP switch 2 to set second-stage heat ON delay. OFF-7 minutes. ON-12 minutes.</i>	ON	DO NOT CUT ANY ON-BOARD LINKS 	<table border="0"> <tr> <td>S1 T'STAT</td> <td>FURNACE TERM. STRIP</td> <td>OUTDOOR UNIT</td> </tr> <tr> <td></td> <td align="center">DS</td> <td></td> </tr> <tr> <td></td> <td align="center">H</td> <td></td> </tr> <tr> <td></td> <td align="center">W2</td> <td></td> </tr> <tr> <td>W2</td> <td></td> <td></td> </tr> <tr> <td>W1</td> <td align="center">W1</td> <td></td> </tr> <tr> <td>R</td> <td align="center">R</td> <td align="center">* R</td> </tr> <tr> <td>G</td> <td align="center">G</td> <td></td> </tr> <tr> <td>C</td> <td align="center">C</td> <td align="center">C</td> </tr> <tr> <td></td> <td align="center">Y2</td> <td></td> </tr> <tr> <td>Y</td> <td align="center">Y1</td> <td align="center">Y1</td> </tr> <tr> <td></td> <td align="center">O</td> <td></td> </tr> </table>	S1 T'STAT	FURNACE TERM. STRIP	OUTDOOR UNIT		DS			H			W2		W2			W1	W1		R	R	* R	G	G		C	C	C		Y2		Y	Y1	Y1		O	
S1 T'STAT	FURNACE TERM. STRIP	OUTDOOR UNIT																																					
	DS																																						
	H																																						
	W2																																						
W2																																							
W1	W1																																						
R	R	* R																																					
G	G																																						
C	C	C																																					
	Y2																																						
Y	Y1	Y1																																					
	O																																						
1 Heat / 2 Cool <i>NOTE - Use DIP switch 2 to set second-stage heat ON delay. OFF-7 minutes. ON-12 minutes.</i>	ON	CUT ON-BOARD LINK W915 2 STAGE COMPR 	<table border="0"> <tr> <td>S1 T'STAT</td> <td>FURNACE TERM. STRIP</td> <td>OUTDOOR UNIT</td> </tr> <tr> <td></td> <td align="center">DS</td> <td></td> </tr> <tr> <td></td> <td align="center">H</td> <td></td> </tr> <tr> <td></td> <td align="center">W2</td> <td></td> </tr> <tr> <td>W</td> <td align="center">W1</td> <td></td> </tr> <tr> <td>R</td> <td align="center">R</td> <td align="center">* R</td> </tr> <tr> <td>G</td> <td align="center">G</td> <td></td> </tr> <tr> <td>C</td> <td align="center">C</td> <td align="center">C</td> </tr> <tr> <td>Y2</td> <td align="center">Y2</td> <td align="center">Y2</td> </tr> <tr> <td>Y1</td> <td align="center">Y1</td> <td align="center">Y1</td> </tr> <tr> <td></td> <td align="center">O</td> <td></td> </tr> </table>	S1 T'STAT	FURNACE TERM. STRIP	OUTDOOR UNIT		DS			H			W2		W	W1		R	R	* R	G	G		C	C	C	Y2	Y2	Y2	Y1	Y1	Y1		O				
S1 T'STAT	FURNACE TERM. STRIP	OUTDOOR UNIT																																					
	DS																																						
	H																																						
	W2																																						
W	W1																																						
R	R	* R																																					
G	G																																						
C	C	C																																					
Y2	Y2	Y2																																					
Y1	Y1	Y1																																					
	O																																						
1 Heat / 2 Cool with t'stat with humidity control <i>NOTE - Use DIP switch 2 to set second-stage heat ON delay. OFF-7 minutes. ON-12 minutes.</i>	ON	CUT ON-BOARD LINK W915 2 STAGE COMPR CUT ON-BOARD LINK W914 DEHUM OR HARMONY 	<table border="0"> <tr> <td>S1 T'STAT</td> <td>FURNACE TERM. STRIP</td> <td>OUTDOOR UNIT</td> </tr> <tr> <td align="center">DS</td> <td align="center">DS</td> <td></td> </tr> <tr> <td></td> <td align="center">H</td> <td></td> </tr> <tr> <td></td> <td align="center">W2</td> <td></td> </tr> <tr> <td>W1</td> <td align="center">W1</td> <td></td> </tr> <tr> <td>R</td> <td align="center">R</td> <td align="center">* R</td> </tr> <tr> <td>G</td> <td align="center">G</td> <td></td> </tr> <tr> <td>C</td> <td align="center">C</td> <td align="center">C</td> </tr> <tr> <td>Y2</td> <td align="center">Y2</td> <td align="center">Y2</td> </tr> <tr> <td>Y1</td> <td align="center">Y1</td> <td align="center">Y1</td> </tr> <tr> <td></td> <td align="center">O</td> <td></td> </tr> </table>	S1 T'STAT	FURNACE TERM. STRIP	OUTDOOR UNIT	DS	DS			H			W2		W1	W1		R	R	* R	G	G		C	C	C	Y2	Y2	Y2	Y1	Y1	Y1		O				
S1 T'STAT	FURNACE TERM. STRIP	OUTDOOR UNIT																																					
DS	DS																																						
	H																																						
	W2																																						
W1	W1																																						
R	R	* R																																					
G	G																																						
C	C	C																																					
Y2	Y2	Y2																																					
Y1	Y1	Y1																																					
	O																																						

* Not required on all units.

TABLE 10
SL280 Field Wiring Applications With Conventional Thermostat

Thermostat	DIP Switch Settings and On-Board Links		Wiring Connections																																				
	DIP Switch 1 Thermostat Heating Stages	On Board Links Must Be Cut To Select System Options																																					
2 Heat / 2 Cool	OFF	<p>CUT ON-BOARD LINK W915 2 STAGE COMPR</p> 	<table border="0"> <tr> <td>S1</td> <td>FURNACE</td> <td>OUTDOOR</td> </tr> <tr> <td>T'STAT</td> <td>TERM. STRIP</td> <td>UNIT</td> </tr> <tr> <td>(DB)-----</td> <td>(DB)</td> <td></td> </tr> <tr> <td></td> <td>(H)</td> <td></td> </tr> <tr> <td>(W2)-----</td> <td>(W2)</td> <td></td> </tr> <tr> <td>(W1)-----</td> <td>(W1)</td> <td></td> </tr> <tr> <td>(R)-----</td> <td>(R)</td> <td>*---(R)</td> </tr> <tr> <td>(G)-----</td> <td>(G)</td> <td></td> </tr> <tr> <td>(C)-----</td> <td>(C)</td> <td>(C)</td> </tr> <tr> <td>(Y2)-----</td> <td>(Y2)</td> <td>(Y2)</td> </tr> <tr> <td>(Y1)-----</td> <td>(Y1)</td> <td>(Y1)</td> </tr> <tr> <td></td> <td>(O)</td> <td></td> </tr> </table>	S1	FURNACE	OUTDOOR	T'STAT	TERM. STRIP	UNIT	(DB)-----	(DB)			(H)		(W2)-----	(W2)		(W1)-----	(W1)		(R)-----	(R)	*---(R)	(G)-----	(G)		(C)-----	(C)	(C)	(Y2)-----	(Y2)	(Y2)	(Y1)-----	(Y1)	(Y1)		(O)	
S1	FURNACE	OUTDOOR																																					
T'STAT	TERM. STRIP	UNIT																																					
(DB)-----	(DB)																																						
	(H)																																						
(W2)-----	(W2)																																						
(W1)-----	(W1)																																						
(R)-----	(R)	*---(R)																																					
(G)-----	(G)																																						
(C)-----	(C)	(C)																																					
(Y2)-----	(Y2)	(Y2)																																					
(Y1)-----	(Y1)	(Y1)																																					
	(O)																																						
2 Heat / 2 Cool with t'stat with humidity control	OFF	<p>CUT ON-BOARD LINK W915 2 STAGE COMPR</p> <p>CUT ON-BOARD LINK W914 DEHUM OR HARMONY</p> 	<table border="0"> <tr> <td>S1</td> <td>FURNACE</td> <td>OUTDOOR</td> </tr> <tr> <td>T'STAT</td> <td>TERM. STRIP</td> <td>UNIT</td> </tr> <tr> <td>(DB)-----</td> <td>(DB)</td> <td></td> </tr> <tr> <td></td> <td>(H)</td> <td></td> </tr> <tr> <td>(W2)-----</td> <td>(W2)</td> <td></td> </tr> <tr> <td>(W1)-----</td> <td>(W1)</td> <td></td> </tr> <tr> <td>(R)-----</td> <td>(R)</td> <td>*---(R)</td> </tr> <tr> <td>(G)-----</td> <td>(G)</td> <td></td> </tr> <tr> <td>(C)-----</td> <td>(C)</td> <td>(C)</td> </tr> <tr> <td>(Y2)-----</td> <td>(Y2)</td> <td>(Y2)</td> </tr> <tr> <td>(Y1)-----</td> <td>(Y1)</td> <td>(Y1)</td> </tr> <tr> <td></td> <td>(O)</td> <td></td> </tr> </table>	S1	FURNACE	OUTDOOR	T'STAT	TERM. STRIP	UNIT	(DB)-----	(DB)			(H)		(W2)-----	(W2)		(W1)-----	(W1)		(R)-----	(R)	*---(R)	(G)-----	(G)		(C)-----	(C)	(C)	(Y2)-----	(Y2)	(Y2)	(Y1)-----	(Y1)	(Y1)		(O)	
S1	FURNACE	OUTDOOR																																					
T'STAT	TERM. STRIP	UNIT																																					
(DB)-----	(DB)																																						
	(H)																																						
(W2)-----	(W2)																																						
(W1)-----	(W1)																																						
(R)-----	(R)	*---(R)																																					
(G)-----	(G)																																						
(C)-----	(C)	(C)																																					
(Y2)-----	(Y2)	(Y2)																																					
(Y1)-----	(Y1)	(Y1)																																					
	(O)																																						
2 Heat / 1 Cool with t'stat with humidity control	OFF	<p>CUT ON-BOARD LINK W914 DEHUM OR HARMONY</p> 	<table border="0"> <tr> <td>S1</td> <td>FURNACE</td> <td>OUTDOOR</td> </tr> <tr> <td>T'STAT</td> <td>TERM. STRIP</td> <td>UNIT</td> </tr> <tr> <td>(DB)-----</td> <td>(DB)</td> <td></td> </tr> <tr> <td></td> <td>(H)</td> <td></td> </tr> <tr> <td>(W2)-----</td> <td>(W2)</td> <td></td> </tr> <tr> <td>(W1)-----</td> <td>(W1)</td> <td></td> </tr> <tr> <td>(R)-----</td> <td>(R)</td> <td>*---(R)</td> </tr> <tr> <td>(G)-----</td> <td>(G)</td> <td></td> </tr> <tr> <td>(C)-----</td> <td>(C)</td> <td>(C)</td> </tr> <tr> <td>(Y1)-----</td> <td>(Y1)</td> <td>(Y1)</td> </tr> <tr> <td></td> <td>(O)</td> <td></td> </tr> </table>	S1	FURNACE	OUTDOOR	T'STAT	TERM. STRIP	UNIT	(DB)-----	(DB)			(H)		(W2)-----	(W2)		(W1)-----	(W1)		(R)-----	(R)	*---(R)	(G)-----	(G)		(C)-----	(C)	(C)	(Y1)-----	(Y1)	(Y1)		(O)				
S1	FURNACE	OUTDOOR																																					
T'STAT	TERM. STRIP	UNIT																																					
(DB)-----	(DB)																																						
	(H)																																						
(W2)-----	(W2)																																						
(W1)-----	(W1)																																						
(R)-----	(R)	*---(R)																																					
(G)-----	(G)																																						
(C)-----	(C)	(C)																																					
(Y1)-----	(Y1)	(Y1)																																					
	(O)																																						
2 Heat / 1 Cool	OFF	<p>DO NOT CUT ANY ON-BOARD LINKS</p> 	<table border="0"> <tr> <td>S1</td> <td>FURNACE</td> <td>OUTDOOR</td> </tr> <tr> <td>T'STAT</td> <td>TERM. STRIP</td> <td>UNIT</td> </tr> <tr> <td>(DB)-----</td> <td>(DB)</td> <td></td> </tr> <tr> <td></td> <td>(H)</td> <td></td> </tr> <tr> <td>(W2)-----</td> <td>(W2)</td> <td></td> </tr> <tr> <td>(W1)-----</td> <td>(W1)</td> <td></td> </tr> <tr> <td>(R)-----</td> <td>(R)</td> <td>*---(R)</td> </tr> <tr> <td>(G)-----</td> <td>(G)</td> <td></td> </tr> <tr> <td>(C)-----</td> <td>(C)</td> <td>(C)</td> </tr> <tr> <td></td> <td>(Y2)</td> <td></td> </tr> <tr> <td>(Y)-----</td> <td>(Y1)</td> <td>(Y1)</td> </tr> <tr> <td></td> <td>(O)</td> <td></td> </tr> </table>	S1	FURNACE	OUTDOOR	T'STAT	TERM. STRIP	UNIT	(DB)-----	(DB)			(H)		(W2)-----	(W2)		(W1)-----	(W1)		(R)-----	(R)	*---(R)	(G)-----	(G)		(C)-----	(C)	(C)		(Y2)		(Y)-----	(Y1)	(Y1)		(O)	
S1	FURNACE	OUTDOOR																																					
T'STAT	TERM. STRIP	UNIT																																					
(DB)-----	(DB)																																						
	(H)																																						
(W2)-----	(W2)																																						
(W1)-----	(W1)																																						
(R)-----	(R)	*---(R)																																					
(G)-----	(G)																																						
(C)-----	(C)	(C)																																					
	(Y2)																																						
(Y)-----	(Y1)	(Y1)																																					
	(O)																																						

* Not required on all units.

TABLE 10
SL280 Field Wiring Applications With Conventional Thermostat

Thermostat	DIP Switch Settings and On-Board Links		Wiring Connections																																													
	DIP Switch 1 Thermostat Heating Stages	On Board Links Must Be Cut To Select System Options																																														
Dual Fuel Single Stage Heat Pump ComfortSense thermostat w/ dual fuel capabilities Capable of 2 stage gas heat control	OFF		<table border="0"> <tr> <td>L7742U T'STAT</td> <td>FURNACE TERM. STRIP</td> <td>HEAT PUMP</td> </tr> <tr> <td>(R) --- (R) --- (R)</td> <td>(R) --- (R)</td> <td>(R)</td> </tr> <tr> <td>(H) --- (H)</td> <td>(H)</td> <td>(H)</td> </tr> <tr> <td>(W2) --- (W2)</td> <td>(W2) ← 67M41* → (W1)</td> <td>(W1)</td> </tr> <tr> <td>(W1) --- (W1)</td> <td>(W1)</td> <td>(W1)</td> </tr> <tr> <td>(O) --- (O) --- (O)</td> <td>(O) --- (O)</td> <td>(O)</td> </tr> <tr> <td>(L) --- (L) --- (L)</td> <td>(L) --- (L)</td> <td>(L)</td> </tr> <tr> <td>(Y1) --- (Y1) --- (Y1)</td> <td>(Y1) --- (Y1)</td> <td>(Y1)</td> </tr> <tr> <td>(Y2) --- (Y2) --- (Y2)</td> <td>(Y2) --- (Y2)</td> <td>(Y2)</td> </tr> <tr> <td>(G) --- (G) --- (G)</td> <td>(G) --- (G)</td> <td>(G)</td> </tr> <tr> <td>(D) --- (D) --- (D)</td> <td>(DS) --- (DS)</td> <td>(DS)</td> </tr> <tr> <td>(B) --- (B) --- (B)</td> <td>(Y2) --- (Y2)</td> <td>(Y2)</td> </tr> <tr> <td>(C) --- (C) --- (C)</td> <td>(C) --- (C)</td> <td>(C)</td> </tr> <tr> <td>(T) --- (T) --- (T)</td> <td>(T) --- (T)</td> <td>(T)</td> </tr> <tr> <td></td> <td></td> <td>outdoor sensor</td> </tr> </table>	L7742U T'STAT	FURNACE TERM. STRIP	HEAT PUMP	(R) --- (R) --- (R)	(R) --- (R)	(R)	(H) --- (H)	(H)	(H)	(W2) --- (W2)	(W2) ← 67M41* → (W1)	(W1)	(W1) --- (W1)	(W1)	(W1)	(O) --- (O) --- (O)	(O) --- (O)	(O)	(L) --- (L) --- (L)	(L) --- (L)	(L)	(Y1) --- (Y1) --- (Y1)	(Y1) --- (Y1)	(Y1)	(Y2) --- (Y2) --- (Y2)	(Y2) --- (Y2)	(Y2)	(G) --- (G) --- (G)	(G) --- (G)	(G)	(D) --- (D) --- (D)	(DS) --- (DS)	(DS)	(B) --- (B) --- (B)	(Y2) --- (Y2)	(Y2)	(C) --- (C) --- (C)	(C) --- (C)	(C)	(T) --- (T) --- (T)	(T) --- (T)	(T)			outdoor sensor
L7742U T'STAT	FURNACE TERM. STRIP	HEAT PUMP																																														
(R) --- (R) --- (R)	(R) --- (R)	(R)																																														
(H) --- (H)	(H)	(H)																																														
(W2) --- (W2)	(W2) ← 67M41* → (W1)	(W1)																																														
(W1) --- (W1)	(W1)	(W1)																																														
(O) --- (O) --- (O)	(O) --- (O)	(O)																																														
(L) --- (L) --- (L)	(L) --- (L)	(L)																																														
(Y1) --- (Y1) --- (Y1)	(Y1) --- (Y1)	(Y1)																																														
(Y2) --- (Y2) --- (Y2)	(Y2) --- (Y2)	(Y2)																																														
(G) --- (G) --- (G)	(G) --- (G)	(G)																																														
(D) --- (D) --- (D)	(DS) --- (DS)	(DS)																																														
(B) --- (B) --- (B)	(Y2) --- (Y2)	(Y2)																																														
(C) --- (C) --- (C)	(C) --- (C)	(C)																																														
(T) --- (T) --- (T)	(T) --- (T)	(T)																																														
		outdoor sensor																																														
Dual Fuel Two Stage Heat Pump ComfortSense thermostat w/ dual fuel capabilities Capable of 2 stage gas heat control	OFF		<table border="0"> <tr> <td>L7742U T'STAT</td> <td>FURNACE TERM. STRIP</td> <td>HEAT PUMP</td> </tr> <tr> <td>(R) --- (R) --- (R)</td> <td>(R) --- (R)</td> <td>(R)</td> </tr> <tr> <td>(H) --- (H)</td> <td>(H)</td> <td>(H)</td> </tr> <tr> <td>(W2) --- (W2)</td> <td>(W2) ← 67M41* → (W1)</td> <td>(W1)</td> </tr> <tr> <td>(W1) --- (W1)</td> <td>(W1)</td> <td>(W1)</td> </tr> <tr> <td>(O) --- (O) --- (O)</td> <td>(O) --- (O)</td> <td>(O)</td> </tr> <tr> <td>(L) --- (L) --- (L)</td> <td>(L) --- (L)</td> <td>(L)</td> </tr> <tr> <td>(Y1) --- (Y1) --- (Y1)</td> <td>(Y1) --- (Y1)</td> <td>(Y1)</td> </tr> <tr> <td>(Y2) --- (Y2) --- (Y2)</td> <td>(Y2) --- (Y2)</td> <td>(Y2)</td> </tr> <tr> <td>(G) --- (G) --- (G)</td> <td>(G) --- (G)</td> <td>(G)</td> </tr> <tr> <td>(D) --- (D) --- (D)</td> <td>(DS) --- (DS)</td> <td>(DS)</td> </tr> <tr> <td>(B) --- (B) --- (B)</td> <td>(Y2) --- (Y2)</td> <td>(Y2)</td> </tr> <tr> <td>(C) --- (C) --- (C)</td> <td>(C) --- (C)</td> <td>(C)</td> </tr> <tr> <td>(T) --- (T) --- (T)</td> <td>(T) --- (T)</td> <td>(T)</td> </tr> <tr> <td></td> <td></td> <td>outdoor sensor</td> </tr> </table>	L7742U T'STAT	FURNACE TERM. STRIP	HEAT PUMP	(R) --- (R) --- (R)	(R) --- (R)	(R)	(H) --- (H)	(H)	(H)	(W2) --- (W2)	(W2) ← 67M41* → (W1)	(W1)	(W1) --- (W1)	(W1)	(W1)	(O) --- (O) --- (O)	(O) --- (O)	(O)	(L) --- (L) --- (L)	(L) --- (L)	(L)	(Y1) --- (Y1) --- (Y1)	(Y1) --- (Y1)	(Y1)	(Y2) --- (Y2) --- (Y2)	(Y2) --- (Y2)	(Y2)	(G) --- (G) --- (G)	(G) --- (G)	(G)	(D) --- (D) --- (D)	(DS) --- (DS)	(DS)	(B) --- (B) --- (B)	(Y2) --- (Y2)	(Y2)	(C) --- (C) --- (C)	(C) --- (C)	(C)	(T) --- (T) --- (T)	(T) --- (T)	(T)			outdoor sensor
L7742U T'STAT	FURNACE TERM. STRIP	HEAT PUMP																																														
(R) --- (R) --- (R)	(R) --- (R)	(R)																																														
(H) --- (H)	(H)	(H)																																														
(W2) --- (W2)	(W2) ← 67M41* → (W1)	(W1)																																														
(W1) --- (W1)	(W1)	(W1)																																														
(O) --- (O) --- (O)	(O) --- (O)	(O)																																														
(L) --- (L) --- (L)	(L) --- (L)	(L)																																														
(Y1) --- (Y1) --- (Y1)	(Y1) --- (Y1)	(Y1)																																														
(Y2) --- (Y2) --- (Y2)	(Y2) --- (Y2)	(Y2)																																														
(G) --- (G) --- (G)	(G) --- (G)	(G)																																														
(D) --- (D) --- (D)	(DS) --- (DS)	(DS)																																														
(B) --- (B) --- (B)	(Y2) --- (Y2)	(Y2)																																														
(C) --- (C) --- (C)	(C) --- (C)	(C)																																														
(T) --- (T) --- (T)	(T) --- (T)	(T)																																														
		outdoor sensor																																														

* Connect W1 to W1 ONLY if using defrost tempering kit 67M41

NOTE - **Do NOT** make a wire connection between the room thermostat L terminal and the L terminal of the furnace integrated control.

TABLE 10
SL280 Field Wiring Applications With Conventional Thermostat

Thermostat	DIP Switch Settings and On-Board Links		Wiring Connections																																													
	DIP Switch 1 Thermostat Heating Stages	On Board Links Must Be Cut To Select System Options																																														
Dual Fuel Single Stage Heat Pump ComfortSense thermostat w/ dual fuel capabilities Capable of 2 stage gas heat control w/dehumidification control	OFF	CUT ON-BOARD LINK W951 HEAT PUMP CUT ON-BOARD LINK W914 DEHUM OR HARMONY 	<table border="0"> <tr> <td>L7742U T'STAT</td> <td>FURNACE TERM. STRIP</td> <td>HEAT PUMP</td> </tr> <tr> <td>(R) --- (R) --- (R)</td> <td>(R)</td> <td>(R)</td> </tr> <tr> <td>(H) --- (H)</td> <td>(H)</td> <td></td> </tr> <tr> <td>(W2) --- (W2) 67M41*</td> <td>(W2)</td> <td></td> </tr> <tr> <td>(W1) --- (W1) ← 67M41* → (W1)</td> <td>(W1)</td> <td>(W1)</td> </tr> <tr> <td>(O) --- (O)</td> <td>(O)</td> <td>(O)</td> </tr> <tr> <td>(L) --- (L)</td> <td></td> <td>(L)</td> </tr> <tr> <td>(Y1) --- (Y1)</td> <td>(Y1)</td> <td>(Y)</td> </tr> <tr> <td>(Y2) --- (Y2)</td> <td></td> <td></td> </tr> <tr> <td>(G) --- (G)</td> <td>(G)</td> <td></td> </tr> <tr> <td>(D) --- (D)</td> <td>(D)</td> <td></td> </tr> <tr> <td>(B) --- (B)</td> <td>(Y2)</td> <td></td> </tr> <tr> <td>(C) --- (C)</td> <td>(C)</td> <td>(C)</td> </tr> <tr> <td>(T) --- (T)</td> <td></td> <td></td> </tr> <tr> <td>(T) --- (T)</td> <td></td> <td>outdoor sensor</td> </tr> </table>	L7742U T'STAT	FURNACE TERM. STRIP	HEAT PUMP	(R) --- (R) --- (R)	(R)	(R)	(H) --- (H)	(H)		(W2) --- (W2) 67M41*	(W2)		(W1) --- (W1) ← 67M41* → (W1)	(W1)	(W1)	(O) --- (O)	(O)	(O)	(L) --- (L)		(L)	(Y1) --- (Y1)	(Y1)	(Y)	(Y2) --- (Y2)			(G) --- (G)	(G)		(D) --- (D)	(D)		(B) --- (B)	(Y2)		(C) --- (C)	(C)	(C)	(T) --- (T)			(T) --- (T)		outdoor sensor
L7742U T'STAT	FURNACE TERM. STRIP	HEAT PUMP																																														
(R) --- (R) --- (R)	(R)	(R)																																														
(H) --- (H)	(H)																																															
(W2) --- (W2) 67M41*	(W2)																																															
(W1) --- (W1) ← 67M41* → (W1)	(W1)	(W1)																																														
(O) --- (O)	(O)	(O)																																														
(L) --- (L)		(L)																																														
(Y1) --- (Y1)	(Y1)	(Y)																																														
(Y2) --- (Y2)																																																
(G) --- (G)	(G)																																															
(D) --- (D)	(D)																																															
(B) --- (B)	(Y2)																																															
(C) --- (C)	(C)	(C)																																														
(T) --- (T)																																																
(T) --- (T)		outdoor sensor																																														
Dual Fuel Two Stage Heat Pump ComfortSense thermostat w/ dual fuel capabilities Capable of 2 stage gas heat control w/dehumidification	OFF	CUT ON-BOARD LINK W915 2 STAGE COMPR CUT ON-BOARD LINK W951 HEAT PUMP CUT ON-BOARD LINK W914 DEHUM OR HARMONY 	<table border="0"> <tr> <td>L7742U T'STAT</td> <td>FURNACE TERM. STRIP</td> <td>HEAT PUMP</td> </tr> <tr> <td>(R) --- (R) --- (R)</td> <td>(R)</td> <td>(R)</td> </tr> <tr> <td>(H) --- (H)</td> <td>(H)</td> <td></td> </tr> <tr> <td>(W2) --- (W2) 67M41*</td> <td>(W2)</td> <td></td> </tr> <tr> <td>(W1) --- (W1) ← 67M41* → (W1)</td> <td>(W1)</td> <td>(W1)</td> </tr> <tr> <td>(O) --- (O)</td> <td>(O)</td> <td>(O)</td> </tr> <tr> <td>(L) --- (L)</td> <td></td> <td>(L)</td> </tr> <tr> <td>(Y1) --- (Y1)</td> <td>(Y1)</td> <td>(Y1)</td> </tr> <tr> <td>(Y2) --- (Y2)</td> <td></td> <td>(Y2)</td> </tr> <tr> <td>(G) --- (G)</td> <td>(G)</td> <td></td> </tr> <tr> <td>(D) --- (D)</td> <td>(D)</td> <td></td> </tr> <tr> <td>(B) --- (B)</td> <td>(Y2)</td> <td>Y2 out blue</td> </tr> <tr> <td>(C) --- (C)</td> <td>(C)</td> <td>(C)</td> </tr> <tr> <td>(T) --- (T)</td> <td></td> <td></td> </tr> <tr> <td>(T) --- (T)</td> <td></td> <td>outdoor sensor</td> </tr> </table>	L7742U T'STAT	FURNACE TERM. STRIP	HEAT PUMP	(R) --- (R) --- (R)	(R)	(R)	(H) --- (H)	(H)		(W2) --- (W2) 67M41*	(W2)		(W1) --- (W1) ← 67M41* → (W1)	(W1)	(W1)	(O) --- (O)	(O)	(O)	(L) --- (L)		(L)	(Y1) --- (Y1)	(Y1)	(Y1)	(Y2) --- (Y2)		(Y2)	(G) --- (G)	(G)		(D) --- (D)	(D)		(B) --- (B)	(Y2)	Y2 out blue	(C) --- (C)	(C)	(C)	(T) --- (T)			(T) --- (T)		outdoor sensor
L7742U T'STAT	FURNACE TERM. STRIP	HEAT PUMP																																														
(R) --- (R) --- (R)	(R)	(R)																																														
(H) --- (H)	(H)																																															
(W2) --- (W2) 67M41*	(W2)																																															
(W1) --- (W1) ← 67M41* → (W1)	(W1)	(W1)																																														
(O) --- (O)	(O)	(O)																																														
(L) --- (L)		(L)																																														
(Y1) --- (Y1)	(Y1)	(Y1)																																														
(Y2) --- (Y2)		(Y2)																																														
(G) --- (G)	(G)																																															
(D) --- (D)	(D)																																															
(B) --- (B)	(Y2)	Y2 out blue																																														
(C) --- (C)	(C)	(C)																																														
(T) --- (T)																																																
(T) --- (T)		outdoor sensor																																														

* Connect W1 to W1 ONLY if using defrost tempering kit 67M41

NOTE - **Do NOT** make a wire connection between the room thermostat L terminal and the L terminal of the integrated control.

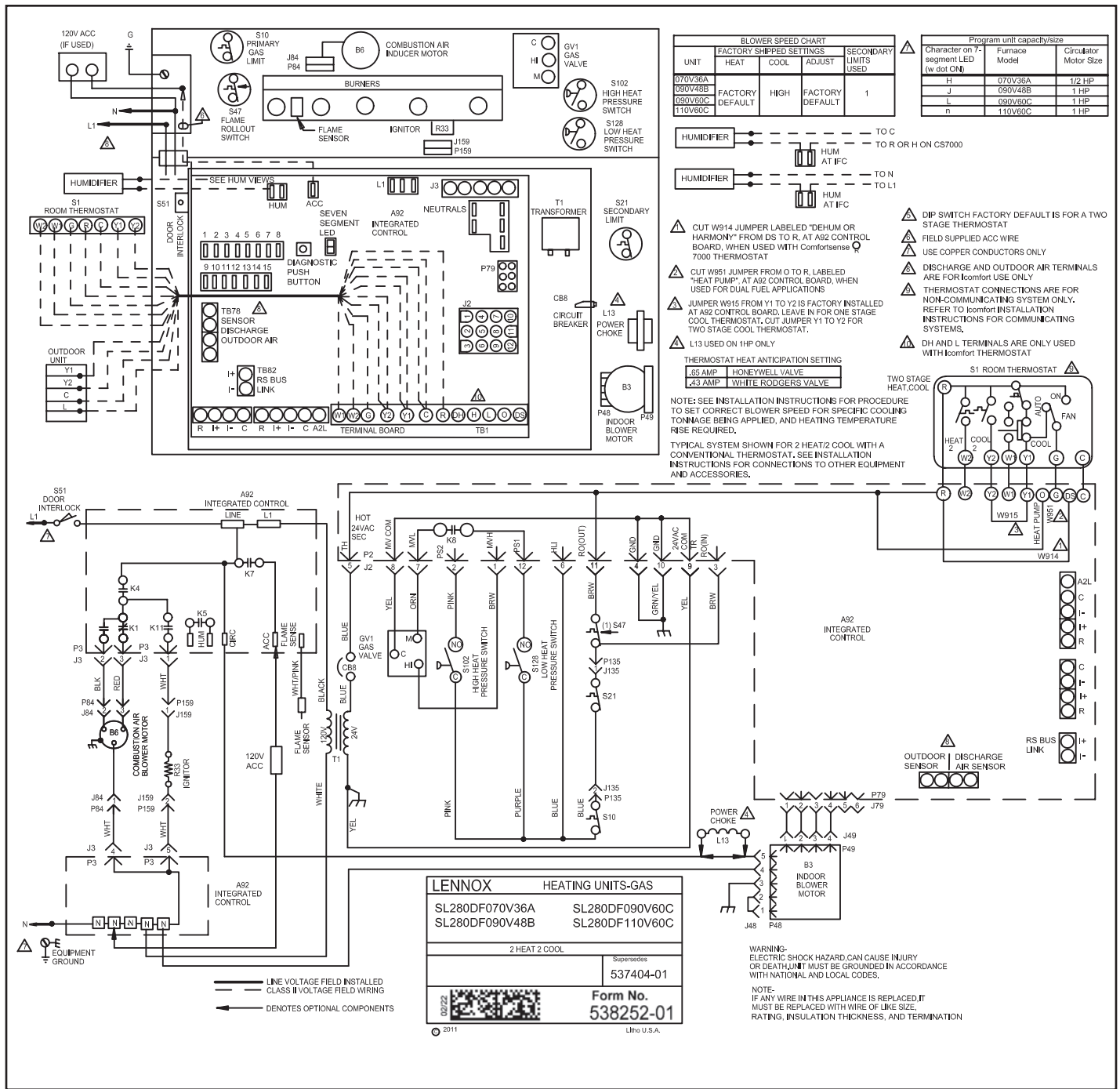
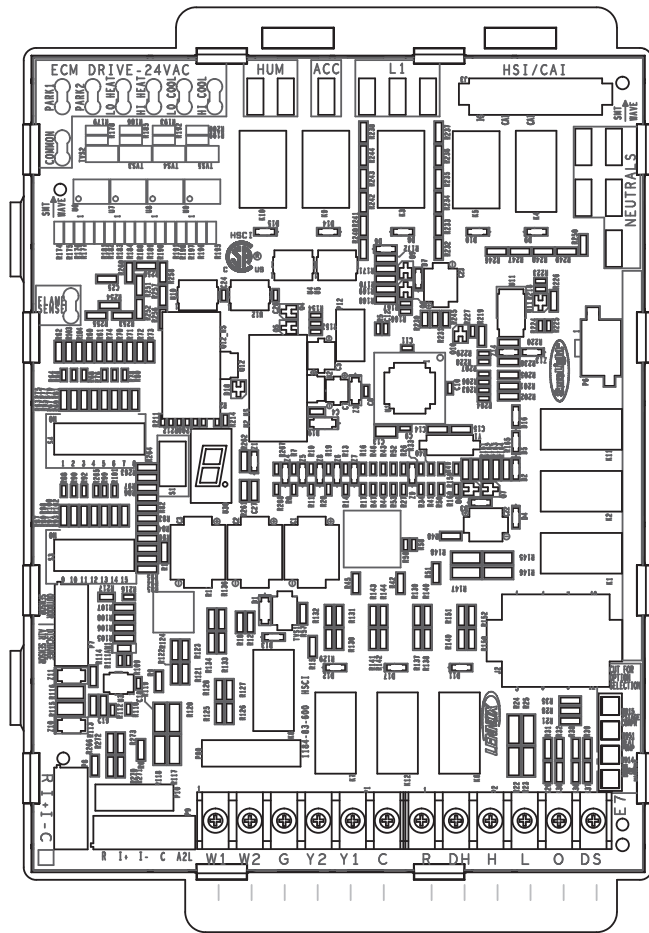

FIGURE 22



RS-BUS LINK (TB82, future use)

- I+ = DATA HIGH CONNECTION
- I- = DATA LOW CONNECTION
- R = 24VAC
- I+ = DATA HIGH CONNECTION
- I- = DATA LOW CONNECTION
- C = 24VAC COMMON (ground)

RS-BUS INDOOR (TB84)

- R = 24VAC
- I+ = DATA HIGH CONNECTION
- I- = DATA LOW CONNECTION
- C = 24VAC COMMON
- A2L=A2L REFRIGERANT

1/4" QUICK CONNECT TERMINALS

- HUM = UNPOWERED NORMALLY OPEN (DRY) CONTACTS
- XMFR = 120 VAC OUTPUT TO TRANSFORMER
- LI = 120 VAC INPUT TO CONTROL
- ACC = 120 VAC OUTPUT TO OPTIONAL ACCESSORY
- NEUTRALS = 120 VAC NEUTRAL

THERMOSTAT CONNECTIONS (TB1)

- DS = DEHUMIDIFICATION SIGNAL
- W2 = HEAT DEMAND FROM 2ND STAGE T/STAT
- W1 = HEAT DEMAND FROM 1ST STAGE T/STAT
- R = CLASS 2 VOLTAGE TO THERMOSTAT
- G = MANUAL FAN FROM T'STAT
- C = THERMOSTAT SIGNAL GROUND CONNECTED TO TRANSFORMER GRD (TR) & CHASIS GROUND (GRD)
- Y1 = THERMOSTAT 1ST STAGE COOL SIGNAL
- Y2 = THERMOSTAT 2ND STAGE COOL SIGNAL
- O = THERMOSTAT SIGNAL TO HEAT PUMP REVERSING VALVE
- DH = DEHUMIDIFICATION OUTPUT COMMUNICATING THERMOSTAT ONLY
- L = NOT USED
- H = LOW VOLTAGE (24 VAC) HUMIDIFICATION

FIGURE 23

**Integrated Control DIP Switch Settings -
Conventional Thermostat (non-communicating)**

SL280DFV units are equipped with a two-stage, variable speed integrated control. This control manages ignition timing, heating mode fan off delays and indoor blower speeds based on selections made using the control dip switches and jumpers. The control includes an internal watchdog feature which automatically resets the ignition control when it has been locked out. After one hour of continuous thermostat demand for heat, the watchdog will break and remake thermostat demand to the furnace and automatically reset the control to relight the furnace.

Note: All communicating settings are set at the thermostat. See thermostat installation instruction. In communication system all DIP switch and clippable link settings are ignored. For conventional thermostats proceed with DIP switch and clippable link settings as outlined in the following.

Heating Operation DIP Switch Settings

Switch 1 -- Thermostat Selection -- This unit may be used with either a single-stage or two-stage thermostat. The thermostat selection is made using a DIP switch which must be properly positioned for the particular application. The DIP switch is factory-positioned for use with a two-stage thermostat. If a single-stage thermostat is to be used, the DIP switch must be repositioned.

- a. Select "OFF" for two-stage heating operation controlled by a two-stage heating thermostat (factory setting);
- b. Select "ON" for two-stage heating operation controlled by a single-stage heating thermostat. This setting provides a timed delay before second-stage heat is initiated.

Switch 2 -- Second Stage Delay (Used with Single-Stage Thermostat Only) -- This switch is used to determine the second stage on delay when a single-stage thermostat is being used. The switch is factory-set in the OFF position, which provides a 7-minute delay before secondstage heat is initiated. If the switch is toggled to the ON position, it will provide a 12-minute delay before secondstage heat is initiated. This switch is only activated when the thermostat selector jumper is positioned for SINGLEstage thermostat use.

Switches 3 and 4 -- Blower-Off Delay -- The blower-on delay of 30 seconds is not adjustable. The blower-off delay (time that the blower operates after the heating demand has been satisfied) can be adjusted by moving switches 3 and 4 on the integrated control. The unit is shipped from the factory with a blower-off delay of 90 seconds. The blower off delay affects comfort and is adjustable to satisfy individual applications. Adjust the blower off delay to achieve a supply air temperature between 90° and 110°F at the exact moment that the blower is de-energized. Longer off delay settings provide lower supply air temperatures; shorter settings provide higher supply air temperatures. TABLE 11 provides the blower off timings that will result from different switch settings.

**TABLE 11
Blower Off Delay Switch Settings**

Blower Off Delay (Seconds)	Switch 3	Switch 4
60	On	Off
90 (factory)	Off	Off
120	Off	Off
180	On	Off

Indoor Blower Operation DIP Switch Settings Switches 5 and 6 -- Cooling Mode Blower Speed -- The unit is shipped from the factory with the dip switches positioned for high speed (4) indoor blower motor operation during the cooling mode. TABLE 12 provides the cooling mode blower speeds that will result from different switch settings. Switches 5 and 6 set the blower cfm for secondstage cool. The integrated control automatically ramps down to 70% of the second-stage cfm for first-stage cfm. Refer to tables for corresponding cfm values.

**TABLE 12
Cooling Mode Blower Speeds**

Speed	Switch 5	Switch 6
Low	On	On
Medium Low	Off	On
Medium High	On	Off
High (Factory)	Off	Off

Switches 7 and 8 -- Cooling Blower Speed Adjustment

-- The unit is shipped from the factory with the dip switches positioned for NORMAL (no) adjustment. The dip switches may be positioned to adjust the blower speed by +10% or -10% to better suit the application. TABLE 13 below provides blower speed adjustments that will result from different switch settings. Refer to tables for corresponding cfm values.

**TABLE 13
Cooling Blower Speed Adjustment**

Adjustment	Switch 7	Switch 8
+10% (approx.)	On	Off
Factory Default	Off	Off
-10% (approx.)	Off	On

Switches 9 and 10 -- Cooling Mode Blower Speed Ramping -- Blower speed ramping may be used to enhance dehumidification performance. The switches are factory set at option A which has the greatest effect on dehumidification performance. TABLE 14 provides the cooling mode blower speed ramping options that will result from different switch settings. The cooling mode blower speed ramping options are detailed on the next page.

NOTE - The off portion of the selected ramp profile also applies during heat pump operation in dual fuel applications.

TABLE 14
Cooling Mode Speed Ramping

Ramping Option	Switch 9	Switch 10
A (factory)	Off	Off
B	Off	On
C	On	Off
D	On	On

Ramping Option A (Factory Selection)

- Motor runs at 50% for 30 seconds.
- Motor then runs at 82% for approximately 7-1/2 minutes.
- If demand has not been satisfied after 7-1/2 minutes, motor runs at 100% until demand is satisfied.
- Once demand is met, motor runs at 50% for 30 seconds then ramps down to stop.

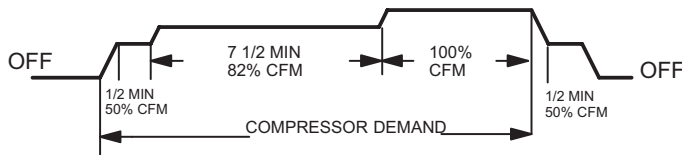

Ramping Option B

- Motor runs at 82% for approximately 7-1/2 minutes. If demand has not been satisfied after 7-1/2 minutes, motor runs at 100% until demand is satisfied.
- Once demand is met, motor ramps down to stop.



Ramping Option C

- Motor runs at 100% until demand is satisfied.
- Once demand is met, motor runs at 100% for 45 seconds then ramps down to stop.

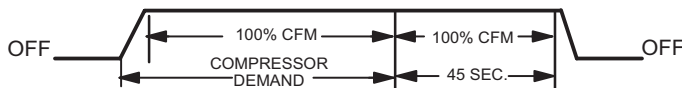

Ramping Option D

- Motor runs at 100% until demand is satisfied.
- Once demand is met, motor ramps down to stop.



Switches 11, 12 and 13 -- Heating Mode Blower Speed

The switches are factory set to the OFF position which provides normal heat speed. Refer to TABLE 15 for switches 11, 12 and 13 that provided the corresponding increases or decrease to both high and low heat demand. See TABLE 24 on page 56 for allowable heating speeds.

TABLE 15

Heating Mode Blower Speeds

Heat Speed	Switch 11	Switch 12	Switch 13
Increase 24%	On	On	On
Increase 18%	On	On	Off
Increase 12%	On	Off	On
Increase 6%	On	Off	Off
Factory Default	Off	Off	Off
Decrease 6%	Off	Off	On
Decrease 12%	Off	On	Off
Decrease 18%	Off	On	On

Switches 14 and 15 -- Continuous Blower Speed

TABLE 16 provides continuous blower speed adjustments that will result from different switch settings.

TABLE 16

Continuous Blower Speed

Continuous Blower Speed	Switch 14	Switch 15
28% of High Cool Speed	Off	On
38% of High Cool Speed (Factory Setting)	Off	Off

Switch 16 - Not Used

On-Boards Links

Note: In communicating systems with a conventional outdoor unit (non-communicating), the on-board clippable links must be set to properly configure the system.

WARNING

Carefully review all configuration information provided. Failure to properly set DIP switches, jumpers and on-board links can result in improper operation!

On-Board Link W914 Dehum or Harmony (R to DS)

On-board link W914, is a clippable connection between terminals R and DS on the integrated control. W914 must be cut when the furnace is installed with either the Harmony III zone control or a thermostat which features humidity control. If the link is left intact the PMW signal from the Harmony III control will be blocked and also lead to control damage. Refer to TABLE 17 for operation sequence in applications including SL280DFV, a thermostat which features humidity control and a single-speed outdoor unit. TABLE 18 gives the operation sequence in applications with a tw speed outdoor unit.

On-Board Link W951 Heat Pump (R to O)

On-board link W951 is a clippable connection between terminals R and O on the integrated control. W951 must be cut when the furnace is installed in applications which include a heat pump unit and a thermostat which features dual fuel use. If the link is left intact, terminal "O" will remain energized eliminating the HEAT MODE in the heat pump.

On-Board Link W915 2 Stage Compr (Y1 to Y2)

On-board link W915 is a clippable connection between terminals Y1 and Y2 on the integrated control. W915 must be cut if two-stage cooling will be used. If the Y1 to Y2 link is not cut the outdoor unit will operate in second-stage cooling only.

Diagnostic LED (FIGURE 23)

The seven-segment diagnostic LED displays operating status, target airflow, error codes and other information. The table beginning on Page 45 lists diagnostic LED codes.

Diagnostic Push Button (FIGURE 23)

The diagnostic push button is located adjacent to the seven-segment diagnostic LED. This button is used to enable the Error Code Recall "E" mode and the Flame Signal "F" mode. Press the button and hold it to cycle through a menu of options. Every five seconds a new menu item will be displayed. When the button is released, the displayed item will be selected. Once all items in the menu have been displayed, the menu resumes from the beginning until the button is released.

Error Code Recall Mode

Select "E" from the menu to access the most recent 10 error codes. Select "c" from the Error Code Recall menu to clear all error codes. Button must be pressed a second time while "c" is flashing to confirm command to delete codes. Press the button until a solid "≡" is displayed to exit the Error Code Recall mode.

Flame Signal Mode

Select "F" from the menu to access the flame signal mode. The integrated control will display the flame current on 7 segment LED in in micro amps (uA).

Flame signal mode is exited after the following:

- Power is reset.
- Pressing and holding push button until 3 horizontal lines "≡" are displayed.
- 10 minutes of entering the flame sense mode.

BLOWER DATA

SL280DF070V36A BLOWER PERFORMANCE (less filter)

0 through 0.8 in. w.g. (Heating) and 0 through 1.0 in. w.g. (Cooling) External Static Pressure Range

HEATING		
¹ Heating Speed DIP Switch Settings	First Stage Heating Speed - cfm	Second Stage Heating Speed - cfm
+24%	1065	1170
+18%	1010	1115
+12%	960	1055
+6%	910	1000
Factory Default	860	945
-6%	805	885
-12%	755	830
-18%	705	775

COOLING								
¹ Cooling Speed DIP Switch Settings	First Stage Cooling Speed - cfm				Second Stage Cooling Speed - cfm			
	Low	Medium-Low	Medium-High	² High	Low	Medium-Low	Medium-High	² High
+	667	756	872	1010	1015	1101	1241	1427
Factory Default	618	683	778	924	922	1014	1115	1304
-	537	619	691	811	800	900	1024	1169

¹ Cooling and heating speeds are based on a combination of DIP switch settings on the furnace control. Refer to Installation Instructions for specific DIP Switch Settings.

² Factory default setting.

NOTES - The effect of static pressure is included in air volumes shown.

First stage HEAT is approximately 91% of the same second stage HEAT.

First stage COOL (two-stage air conditioning units only) is approximately 70% of the same second stage COOL speed position.

Continuous Fan Only speed is selectable at 28% and 38% of the selected second stage cooling speed - minimum 250 cfm.

Lennox iHarmony® Zoning System Applications - Minimum blower speed is 250 cfm.

BLOWER DATA

SL280DF090V48B BLOWER PERFORMANCE (less filter)

0 through 0.8 in. w.g. (Heating) and 0 through 1.0 in. w.g. (Cooling) External Static Pressure Range

HEATING		
¹ Heating Speed DIP Switch Settings	First Stage Heating Speed - cfm	Second Stage Heating Speed - cfm
+24%	1360	1500
+18%	1285	1415
+12%	1220	1350
+6%	1135	1285
Factory Default	1075	1200
-6%	1030	1110
-12%	960	1050
-18%	890	975

COOLING								
¹ Cooling Speed DIP Switch Settings	First Stage Cooling Speed - cfm				Second Stage Cooling Speed - cfm			
	Low	Medium-Low	Medium-High	² High	Low	Medium-Low	Medium-High	² High
+	740	905	1040	1220	1085	1330	1545	1730
Factory Default	690	820	950	1110	990	1200	1400	1,595
-	610	745	855	1005	895	1075	1270	1460

¹ Cooling and heating speeds are based on a combination of DIP switch settings on the furnace control. Refer to Installation Instructions for specific DIP Switch Settings.

² Factory default setting.

NOTES - The effect of static pressure is included in air volumes shown.

First stage HEAT is approximately 91% of the same second stage HEAT.

First stage COOL (two-stage air conditioning units only) is approximately 70% of the same second stage COOL speed position.

Continuous Fan Only speed is selectable at 28% and 38% of the selected second stage cooling speed - minimum 380 cfm.

Lennox iHarmony® Zoning System Applications - Minimum blower speed is 380 cfm.

BLOWER DATA

SL280DF090V60C BLOWER PERFORMANCE (less filter)

0 through 0.8 in. w.g. (Heating) and 0 through 1.0 in. w.g. (Cooling) External Static Pressure Range

HEATING		
¹ Heating Speed DIP Switch Settings	First Stage Heating Speed - cfm	Second Stage Heating Speed - cfm
+24%	1540	1695
+18%	1465	1615
+12%	1390	1530
+6%	1320	1450
Factory Default	1245	1365
-6%	1170	1285
-12%	1095	1205
-18%	1020	1120

COOLING								
¹ Cooling Speed DIP Switch Settings	First Stage Cooling Speed - cfm				Second Stage Cooling Speed - cfm			
	Low	Medium-Low	Medium-High	² High	Low	Medium-Low	Medium-High	² High
+	1125	1250	1400	1590	1585	1770	2000	2275
Factory Default	1020	1135	1285	1445	1420	1610	1845	2,050
-	900	1005	1155	1280	1305	1395	1645	1875

¹ Cooling and heating speeds are based on a combination of DIP switch settings on the furnace control. Refer to Installation Instructions for specific DIP Switch Settings.

² Factory default setting.

NOTES - The effect of static pressure is included in air volumes shown.

First stage HEAT is approximately 91% of the same second stage HEAT.

First stage COOL (two-stage air conditioning units only) is approximately 70% of the same second stage COOL speed position.

Continuous Fan Only speed is selectable at 28% and 38% of the selected second stage cooling speed - minimum 450 cfm.

Lennox iHarmony® Zoning System Applications - Minimum blower speed is 450 cfm.

BLOWER DATA

SL280DF110V60C BLOWER PERFORMANCE (less filter)

0 through 0.8 in. w.g. (Heating) and 0 through 1.0 in. w.g. (Cooling) External Static Pressure Range

¹ Heating Speed DIP Switch Settings	First Stage Heating Speed - cfm	Second Stage Heating Speed - cfm
+24%	1645	1810
+18%	1565	1720
+12%	1485	1635
+6%	1405	1545
Factory Default	1325	1460
-6%	1245	1370
-12%	1170	1285
-18%	1090	1195

¹ Cooling Speed DIP Switch Settings	First Stage Cooling Speed - cfm				Second Stage Cooling Speed - cfm			
	Low	Medium-Low	Medium-High	² High	Low	Medium-Low	Medium-High	² High
+	1055	1230	1365	1525	1500	1755	1915	2120
Factory Default	975	1115	1250	1400	1360	1585	1770	1960
-	895	1005	1130	1245	1225	1405	1595	1760

¹ Cooling and heating speeds are based on a combination of DIP switch settings on the furnace control. Refer to Installation Instructions for specific DIP Switch Settings.

² Factory default setting.

NOTES - The effect of static pressure is included in air volumes shown.

First stage HEAT is approximately 91% of the same second stage HEAT.

First stage COOL (two-stage air conditioning units only) is approximately 70% of the same second stage COOL speed position.

Continuous Fan Only speed is selectable at 28% and 38% of the selected second stage cooling speed - minimum 450 cfm.

Lennox iHarmony® Zoning System Applications - Minimum blower speed is 450 cfm.

**TABLE 17
OPERATING SEQUENCE**

SL280DFV Non-Communicating Thermostat with Humidity Control Feature and Single-Speed Outdoor Unit

OPERATING SEQUENCE		SYSTEM DEMAND				SYSTEM RESPONSE				
System Condition	Step	Thermostat Demand				Relative Humidity		Compressor	Blower CFM (cool)	Comments
		Y1	O	G	W1	Status	D			
<i>NO CALL FOR DEHUMIDIFICATION</i>										
Normal Operation	1	On	On	On		Acceptable	24 VAC	High	100%	Compressor and indoor blower follow thermostat demand
<i>BASIC MODE (only active on a Y1 thermostat demand)</i>										
Normal Operation	1	On	On	On		Acceptable	24 VAC	High	100%	ComfortSense® 7500 thermostat energizes Y1 and de-energizes D on a call for dehumidification
Dehumidification call	2	On	On	On		Demand	0 VAC	High	70%*	
<i>PRECISION MODE (operates independent of a Y1 demand)</i>										
Normal Operation	1	On	On	On		Acceptable	24 VAC	High	100%	Dehumidification mode begins when humidity is greater than set point
Dehumidification Call	2	On	On	On		Demand	0 VAC	High	70%*	
Dehumidification Call Only	1	On	On	On		Demand	0 VAC	High	70%*	ComfortSense® 7500 thermostat will try to maintain room humidity setpoint by allowing the room space to maintain a cooler room thermostat setpoint**
	Jumpers at indoor unit with a single stage outdoor unit. With Condensing unit - Cut W914 (R to DS) on SureLight® control With Heat Pump - Cut W914 (R to DS) & W951 (R to O) on SureLight® control									

Dave Lennox ComfortSense® 7500 thermostat to use for this application - Y2081 4 heat / 2 cool

**Dehumidification blower speed is 70% of COOL speed for all units .*

***In Precision mode, ComfortSense® 7000 thermostat will maintain room temperature up to 2 °F (1.2°C) cooler than room setting.*

**TABLE 18
OPERATING SEQUENCE**

SL280DFV, Non-Communicating Thermostat with Humidity Control Feature and Two-Speed Outdoor Unit

OPERATING SEQUENCE		SYSTEM DEMAND						SYSTEM RESPONSE				
System Condition	Step	Thermostat Demand						Relative Humidity		Compressor	Blower CFM (cool)	Comments
		Y1	Y2	O	G	W1	W2	Status	D			
NO CALL FOR DEHUMIDIFICATION												
Normal Operation Y1	1	On		On	On			Acceptable	24 VAC	Low	70%*	Compressor and indoor blower follow thermostat demand
Normal Operation Y2	2	On	On	On	On			Acceptable	24 VAC	High	100%	
ROOM THERMOSTAT CALLS FOR FIRST STAGE COOLING												
BASIC MODE (only active on a Y1 thermostat demand)												
Normal Operation	1	On		On	On			Acceptable	24 VAC	Low	70%*	ComfortSense® 7500 thermostat energizes Y1 and de-energizes D on a call for de-humidification
Dehumidification call	2	On	On	On	On			Demand	0 VAC	High	70%**	
PRECISION MODE (operates independent of a Y1 demand)												
Normal Operation	1	On		On	On			Acceptable	24 VAC	Low	70%*	Dehumidification mode begins when humidity is greater than set point
Dehumidification Call	2	On	On	On	On			Demand	0 VAC	High	70%**	
Dehumidification Call Only	1	On	On	On	On			Demand	0 VAC	High	70%**	ComfortSense® 7500 thermostat will try to maintain room humidity setpoint by allowing the room space to maintain a cooler room thermostat setpoint**
ROOM THERMOSTAT CALLS FOR FIRST AND SECOND STAGE COOLING												
BASIC MODE (only active on a Y1 thermostat demand)												
Normal Operation	1	On	On	On	On			Acceptable	24 VAC	High	100%	ComfortSense® 7500 thermostat energizes Y2 and de-energizes D on a call for de-humidification
Dehumidification Call	2	On	On	On	On			Demand	0 VAC	High	70%**	
PRECISION MODE (operates independent of a Y1 thermostat demand)												
Normal Operation	1	On		On	On			Acceptable	24 VAC	Low	70%*	Dehumidification mode begins when humidity is greater than set point
Dehumidification Call	2	On	On	On	On			Demand	0 VAC	High	70%**	
Dehumidification Call ONLY	1	On	On	On	On			Demand	0 VAC	High	70%**	ComfortSense® 7500 thermostat will try to maintain room humidity setpoint by allowing the room space to maintain a cooler room thermostat setpoint***
	Jumpers at indoor unit with a two stage outdoor unit Cut factory jumper from Y1 to Y2 or cut W915 (Y1 to Y2) With Condensing unit - Cut W914 (R to DS) on SureLight® control With Heat Pump - Cut W914 (R to DS) & W951 (R to O) on SureLight® control											
<i>Dave Lennox ComfortSense® 7500 thermostat to use for this application - Y2081 4 heat / 2 cool</i>												
<i>*Normal operation first stage cooling blower speed is 70% COOL speed.</i>												
<i>**Dehumidification blower speed is, reduced to 70% of COOL.</i>												
<i>***In Precision mode, ComfortSense® 7000 thermostat will maintain room temperature up to 2 °F (1.2°C) cooler than room setting.</i>												

Unit Start-Up

FOR YOUR SAFETY READ BEFORE LIGHTING

⚠ WARNING

Do not use this furnace if any part has been underwater. Immediately call a licensed professional service technician (or equivalent) to inspect the furnace and to replace any part of the control system and any gas control which has been under water.

⚠ WARNING

If overheating occurs or if gas supply fails to shut off, shut off the manual gas valve to the appliance before shutting off electrical supply.

⚠ CAUTION

Before attempting to perform any service or maintenance, turn the electrical power to unit OFF at disconnect switch.

⚠ WARNING

During blower operation, the ECM motor emits energy that may interfere with pacemaker operation. Interference is reduced by both the sheet metal cabinet and distance.

BEFORE LIGHTING smell all around the appliance area for gas. Be sure to smell next to the floor because some gas is heavier than air and will settle on the floor.

The gas valve on the SL280DFV unit will be equipped with either a gas control switch. Use only your hand to move the control switch. Never use tools. If the switch will not turn or if the switch will not move by hand, do not try to repair it. Force or attempted repair may result in a fire or explosion.

Placing the furnace into operation:

SL280DFV units are equipped with an automatic ignition system. Do not attempt to manually light burners on these furnaces. Each time the thermostat calls for heat, the burners will automatically light. The ignitor does not get hot when there is no call for heat on units with an automatic ignition system.

⚠ WARNING

If you do not follow these instructions exactly, a fire or explosion may result causing property damage, personal injury or death.

Gas Valve Operation (FIGURE 24)

- 1 - **STOP!** Read the safety information at the beginning of this section.
- 2 - Set the thermostat to the lowest setting.
- 3 - Turn off all electrical power to the unit.
- 4 - This furnace is equipped with an ignition device which automatically lights the burners. Do not try to light the burners by hand.
- 5 - Remove the access panel.
- 6 - Move switch on gas valve to OFF. Do not force. See FIGURE 24.
- 7 - Wait five minutes to clear out any gas. If you then smell gas, **STOP!** Immediately call your gas supplier from a neighbor's phone. Follow the gas supplier's instructions. If you do not smell gas go to next step.

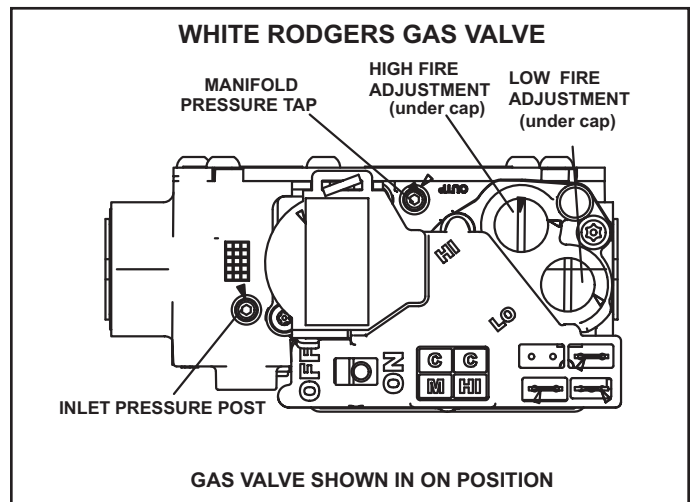

FIGURE 24

- 8 - Move switch on gas valve to ON. Do not force. See FIGURE 24.
 - 9 - Replace the access panel.
 - 10 - Turn on all electrical power to the unit.
 - 11 - Set the thermostat to desired setting.
- NOTE** - When unit is initially started, steps 1 through 11 may need to be repeated to purge air from gas line.
- 12 - If the appliance will not operate, follow the instructions "Turning Off Gas to Unit" and call your service technician or gas supplier.

Turning Off Gas to Unit

- 1 - Set the thermostat to the lowest setting.
- 2 - Turn off all electrical power to the unit if service is to be performed.
- 3 - Remove the upper access panel.
- 4 - Move switch on gas valve to OF. Do not force. See FIGURE 24.
- 5 - Replace the upper access panel.

Failure To Operate

If the unit fails to operate, check the following:

- 1 - Is the thermostat calling for heat?
- 2 - Are access panels securely in place?
- 3 - Is the main disconnect switch closed?
- 4 - Is there a blown fuse or tripped circuit breaker?
- 5 - Is the filter dirty or plugged? Dirty or plugged filters will cause the limit control to shut the unit off.
- 6 - Is gas turned on at the meter?
- 7 - Is the manual main shut-off valve open?
- 8 - Is the internal manual shut-off valve open?
- 9 - Is the unit ignition system in lock out? If the unit locks out again, call the service technician to inspect the unit for blockages.
- 10 - Is pressure switch closed? Obstructed flue will cause unit to shut off at pressure switch. Check flue and outlet for blockages.
- 11 - Is the rollout switch tripped? If the switch is tripped call the service technician to inspect the unit.

Gas Pressure Adjustment

Gas Flow (Approximate)

Furnace should operate at least 5 minutes before checking gas flow. Determine time in seconds for two revolutions of gas through the meter. (Two revolutions assures a more accurate time.) Divide by two and compare to time in TABLE 19 below. If manifold pressure matches TABLE 21 and rate is incorrect, check gas orifices for proper size and restriction. Remove temporary gas meter if installed.

NOTE - Shut unit off and remove manometer as soon as an accurate reading has been obtained. Take care to replace pressure tap plug.

TABLE 19

GAS METERING CLOCKING CHART				
SL280 Unit	Natural 1000 btu/cu ft		LP 2500 btu cu/cu ft	
	Seconds For One Revolution			
	1 cu ft dial	2 cu fr dial	1 cu ft Dial	2 cu ft Dial
-070	55	110	136	272
-090	41	82	102	204
-110	33	66	82	164

Supply Line Pressure

An inlet post located on the gas valve provides access to the supply pressure. See FIGURE 24. Back out the 3/32 hex screw one turn, connect a piece of 5/16 tubing and connect to a manometer to measure supply pressure. See TABLE 21 for supply line pressure.

Manifold Pressure

NOTE - Pressure test adapter kit (10L34) is available from Lennox to facilitate manifold pressure measurement.

A manifold pressure tap located on the gas valve provides access to the manifold pressure. See FIGURE 24. Back out the 3/32 hex screw one turn, connect a piece of 5/16 tubing and connect to a manometer to measure manifold pressure.

- 1 - Connect the test gauge positive side "+" to manifold pressure tap on gas valve as noted above.
- 2 - Ignite unit on **low fire** and let run for 5 minutes to allow for steady state conditions.
- 3 - After allowing unit to stabilize for 5 minutes, record manifold pressure and compare to value given in TABLE 21.
- 4 - If necessary, make adjustments. FIGURE 24 shows location of high fire and low fire adjustment screws.
- 5 - Repeat steps 3, 4 and 5 on high fire. See values in TABLE 21.
- 6 - Shut unit off and remove manometer as soon as an accurate reading has been obtained. Turn the supply and manifold 3/32" hex screws one revolution back into the gas valve.
- 7 - Start unit and perform leak check. Seal leaks if found.

Proper Combustion

Furnace should operate minimum 15 minutes with correct manifold pressure and gas flow rate before checking combustion. Table 20 shows acceptable combustion for ALL SL280DFV models.

TABLE 20

Firing Rate	CO2% For Nat	CO2% For L.P.
High Fire	6.0 - 7.4	6.9 - 8.4
Low Fire	4.8 - 6.0	5.7 - 7.0
The carbon monoxide reading should not exceed 100 ppm.		

High Altitude

The manifold pressure, gas orifice and pressure switch may require adjustment or replacement to ensure proper operation at higher altitudes. Tables 21 through 23 shows manifold pressure, pressures switch and gas conversion kits at all altitudes.

IMPORTANT

For safety, shut unit off and remove manometer as soon as an accurate reading has been obtained. Take care to replace pressure tap plug.

TABLE 21
Manifold Pressure Settings

Unit Input	Gas	Orifice Size 0 - 7500 ft.	Orifice Size 0 - 7500 ft ¹	Manifold Pressure in. wg. 0 - 4500 ft		Manifold Pressure in. wg. 4500 - 7500 ft		Manifold Pressure in. wg. 7500 - 10,000 ft ²		Supply Line Pressure in. w.g.	
				Low Firer	High Fire	Low Fire	High Fire	Low Fire	High Fire	Min	Max
070	Natural	.063	.055	1.7	3.5	1.6	3.4	1.7	3.5	4.5	13.0
	LP/propane ³	.034	.032	4.5	10.0	4.5	10.0	4.5	10.5	11.0	13.0
090	Natural	.063	.055	1.7	3.5	1.5	3.0	1.7	3.5	4.5	13.0
	LP/propane ³	.034	.032	4.5	10.0	4.5	10.0	4.5	10.0	11.0	13.0
110	Natural	.063	.055	1.7	3.5	1.5	3.2	1.7	3.5	4.5	13.0
	LP/propane ³	.034	.032	4.5	10.0	4.5	10.0	4.5	10.0	11.0	13.0

¹ This is the only permissible derate for these units.

² Natural gas high altitude orifice kit required.

³ A natural to L.P. propane gas changeover kit is necessary to convert this unit. Refer to the changeover kit installation instruction for the conversion procedure.

NOTE - Units may be installed at altitudes up to 4500 ft. above sea level without modifications.

TABLE 22

Unit Input	High Altitude Pressure Switch Kit		
	0 - 4500 ft.	4501 - 7500 ft.	7501 - 10,000 ft.
070	No Change	No Change	73W36
090	No Change	69W56	73W36
110	No Change	69W56	73W35

TABLE 23

Unit Input	High Altitude Natural Gas Orifice Kit	Natural Gas to LP/Propane Kit		LP/Propane to Natural Gas Kit
	7501 - 10,000 ft	0 - 7500 ft	7501 - 10,000 ft	0 - 7500 ft
070				
090	73W37	11K51	11K46	77W09
110				

Other Unit Adjustments

Primary and Secondary Limits

The primary limit is located on the heating compartment vestibule panel. The secondary limits (if equipped) are located in the blower compartment, attached to the back side of the blower. These limits are factory set and require no adjustment.

Flame Rollout Switch

This manually reset switch is located inside the burner box. If tripped, check for adequate combustion air before resetting.

Pressure Switches

The pressure switch assembly (includes two switches) is located in the heating compartment adjacent to the combustion air inducer. These switches check for proper combustion air inducer operation before allowing ignition trial. The switches are factory-set and require no adjustment.

Temperature Rise

Place the unit into operation with a second-stage heating demand. After supply and return air temperatures have stabilized, check the temperature rise. If necessary, adjust the heating blower speed to maintain the temperature rise within the range shown on the unit nameplate. See TABLE 25 on page 56 for allowable heating speeds. Increase the blower speed to decrease the temperature rise. Decrease the blower speed to increase the temperature rise. Failure to properly adjust the temperature rise may cause erratic limit operation and may result in premature heat exchanger failure.

Thermostat Heat Anticipation

Set the heat anticipator setting (if adjustable) according to the amp draw listed on the wiring diagram that is attached to the unit.

Heating Sequence of Operation

The two-stage, variable speed integrated control used in SL280DFV units has an added feature of an internal Watchguard control. The feature serves as an automatic reset device for ignition control lockout caused by ignition failure. This type of lockout is usually due to low gas line pressure. After one hour of continuous thermostat demand for heat, the Watchguard will break and remake thermostat demand to the furnace and automatically reset the control to begin the ignition sequence.

NOTE - The integrated control thermostat selection DIP switch is factory-set in the "TWO-STAGE" position.

Applications Using a Two-Stage Thermostat

See FIGURE 25 for ignition control sequence

A - Heating Sequence -- Integrated Control Thermostat Selection DIP Switch 1 OFF in "Two-Stage" Position (Factory Setting)

- 1 - On a call for heat, thermostat first-stage contacts close sending a signal to the integrated control. The integrated control runs a self-diagnostic program and checks high temperature limit switches for normally closed contacts and pressure switches for normally open contacts. The combustion air inducer is energized at low speed.
- 2 - Once the control receives a signal that the low pressure switch has closed, the combustion air inducer begins a 15-second pre-purge in low speed.

NOTE - If the low fire pressure switch does not close the combustion air inducer will switch to high fire. After a 15 second pre-purge the high fire pressure switch will close and the unit will begin operation on high fire. After 10 to 20 seconds of high fire operation the unit will switch to low fire.

- 3 - After the pre-purge is complete, a 20-second initial ignitor warm-up period begins. The combustion air inducer continues to operate at low speed.
- 4 - After the 20-second warm-up period has ended, the gas valve is energized on low fire (first stage) and ignition occurs. At the same time, the control module sends a signal to begin an indoor blower 30-second ON-delay. When the delay ends, the indoor blower motor is energized on the low fire heating speed, the HUM contacts close energizing the humidifier and 120V ACC terminal is energized. The furnace will continue this operation as long as the thermostat has a first-stage heating demand.
- 5 - If second-stage heat is required, the thermostat second-stage heat contacts close and send a signal to the integrated control. The integrated control initiates a 30-second second-stage recognition delay.
- 6 - At the end of the recognition delay, the integrated control energizes the combustion air inducer at high speed. The control also checks the high fire (second stage) pressure switch to make sure it is closed. The high fire (second stage) gas valve is energized and the indoor blower motor is energized for operation at the high fire heating speed.
- 7 - When the demand for high fire (second stage) heat is satisfied, the combustion air inducer is switched to the low-fire heating speed and the high-fire (second stage) gas valve is de-energized. The low-fire (first stage) gas valve continues operation. The indoor blower motor is switched to the low-fire heating speed.
- 8 - When the thermostat demand for low-fire (first stage) heat is satisfied, the gas valve is de-energized and the field-selected indoor blower off delay begins. The combustion air inducer begins a 5-second post-purge period.
- 9 - When the combustion air post-purge period is complete, the inducer, the HUM contacts as well as the 120V ACC terminals are de-energized. The indoor blower is de-energized at the end of the off delay.

Applications Using A Single-Stage Thermostat

See FIGURE 26 for ignition control sequence

B - Heating Sequence -- Control Thermostat Selection DIP Switch 1 ON in "Single-Stage" Position

NOTE - In these applications, two-stage heat will be initiated by the integrated control if heating demand has not been satisfied after the field adjustable period (7 or 12 minutes).

- 1 - On a call for heat, thermostat first-stage contacts close sending a signal to the integrated control. The integrated control runs a self-diagnostic program and checks high temperature limit switches for normally closed contacts and pressure switches for normally open contacts. The combustion air inducer is energized at low speed.
- 2 - Once the control receives a signal that the low pressure switch has closed, the combustion air inducer begins a 15-second pre-purge in low speed. **NOTE** - If the low fire pressure switch does not close the combustion air inducer will switch to high fire. After a 15 second pre-purge the high fire pressure switch will close and the unit will begin operation on high fire. After 10 to 20 seconds of high fire operation the unit will switch to low fire.
- 3 - After the pre-purge is complete, a 20-second initial ignitor warm-up period begins. The combustion
- 4 - After the 20-second warm-up period has ended, the gas valve is energized on low fire (first stage) and ignition occurs. At the same time, the control module sends a signal to begin an indoor blower 30-second ON-delay. When the delay ends, the indoor blower motor is energized on the low fire heating speed and the HUM contacts are energized. The integrated control also initiates a second-stage on delay (factory-set at 7 minutes; adjustable to 12 minutes).
- 5 - If the heating demand continues beyond the secondstage on delay, the integrated control energizes the combustion air inducer at high speed. The control also checks the high fire (second stage) pressure switch to make sure it is closed. The high fire (second stage) gas valve is energized and the indoor blower motor is energized for operation at the high fire heating speed.
- 6 - When the thermostat heating demand is satisfied, the combustion air inducer begins a 5-second low speed post-purge. The field-selected indoor blower off delay begins. The indoor blower operates at the low-fire heating speed.
- 7 - When the combustion air post-purge period is complete, the inducer, the HUM contacts as well as the 120V ACC terminals are de-energized. The indoor blower is de-energized at the end of the off delay.

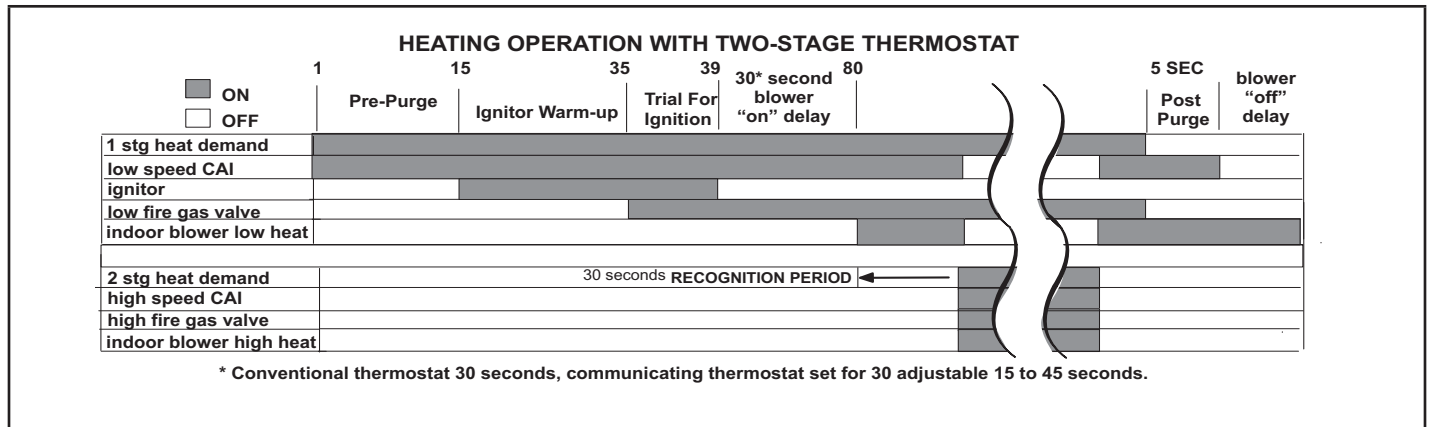

FIGURE 25

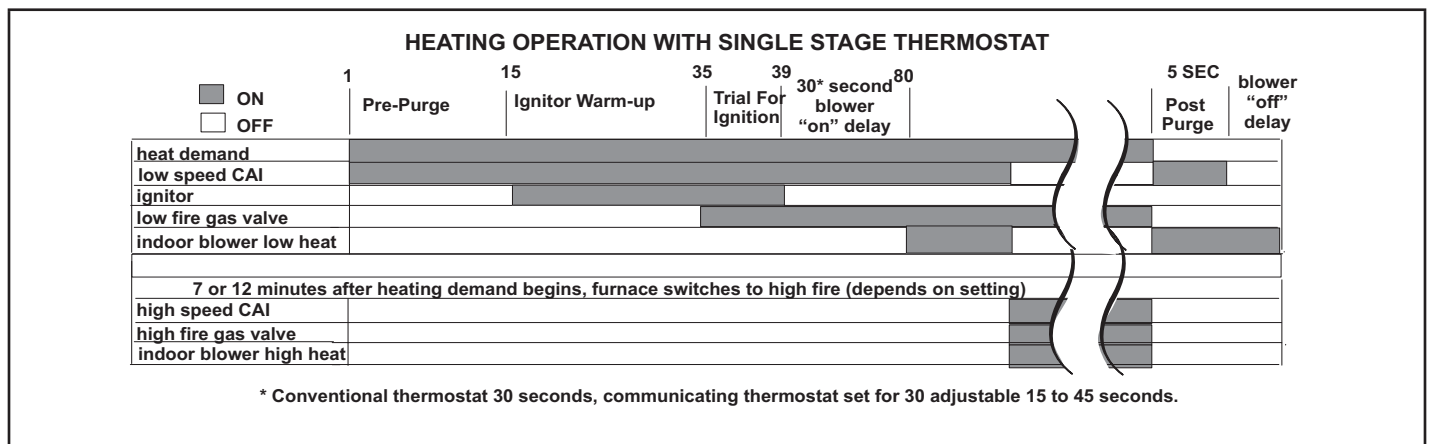

FIGURE 26

⚠ WARNING

**ELECTRICAL SHOCK, FIRE,
OR EXPLOSION HAZARD.**

Failure to follow safety warnings exactly could result in dangerous operation, serious injury, death or property damage. Improper servicing could result in dangerous operation, serious injury, death, or property damage. Before servicing, disconnect all electrical power to furnace. When servicing controls, label all wires prior to disconnecting. Take care to reconnect wires correctly. Verify proper operation after servicing.

⚠ WARNING

The blower door must be securely in place when the blower and burners are operating. Gas fumes, which could contain carbon monoxide, can be drawn into the living space resulting in personal injury or death.

Annual Furnace Maintenance

At the beginning of each heating season, and to comply with the Lennox Limited Warranty, your system should be checked as follows:

- 1 - Check wiring for loose connections, voltage at indoor unit and amperage of indoor motor.
- 2 - Check the condition of the belt and shaft bearings if applicable.
- 3 - Inspect all gas pipe and connections for leaks.
- 4 - Check the cleanliness of filters and change if necessary (monthly).
- 5 - Check the condition and cleanliness of burners and heat exchanger and clean if necessary.
- 6 - Check the cleanliness of blower assembly and clean the housing, blower wheel and blower motor if necessary .
- 7 - Inspect the combustion air inducer and clean if necessary.
- 8 - Evaluate the heat exchanger integrity by inspecting the heat exchanger per the AHRI heat exchanger inspection procedure. This procedure can be viewed at www.ahrinet.org

- 9 - Ensure sufficient combustion air is available to the furnace. Fresh air grilles and louvers (on the unit and in the room where the furnace is installed) must be properly sized, open and unobstructed to provide combustion air.
- 10 - Inspect the furnace venting system to make sure it is in place, structurally sound, and without holes, corrosion, or blockage. Vent system must be free and clear of obstructions and must slope upward away from the furnace . Vent system should be installed per the National Fuel Gas Code
- 11 - Inspect the furnace return air duct connection to ensure the duct is sealed to the furnace. Check for air leaks on supply and return ducts and seal where necessary.
- 12 - Check the condition of the furnace cabinet insulation and repair if necessary.
- 13 - Perform a complete combustion analysis during the furnace inspection to ensure proper combustion and operation. Consult Service Literature for proper combustion values.
- 14 - Verify operation of CO detectors and replace batteries as required.

Perform a general system test. Turn on the furnace to check operating functions such as the start-up and shut-off operation.

- 1 - Check the operation of the ignition system, inspect and clean flame sensor. Check microamps before and after. Check controls and safety devices (gas valve, flame sensor, temperature limits). Consult Service Manual for proper operating range. Thermal Limits should be checked by restricting airflow and not disconnecting the indoor blower. For additional details, please see Service and Application Note H049.
- 2 - Verify that system total static pressure and airflow settings are within specific operating parameters.
- 3 - Clock gas meter to ensure that the unit is operating at the specified firing rate. Check the supply pressure and the manifold pressure. On two-stage gas furnaces check the manifold pressure on high fire and low fire. If manifold pressure adjustment is necessary, consult the Service Literature for unit specific information on adjusting gas pressure. Not all gas valves are adjustable. Verify correct temperature rise.

Cleaning the Burners

NOTE - Use papers or protective covering in front of the furnace during cleaning.

- 1 - Turn off both electrical and gas power supplies to furnace.
- 2 - Label the wires from gas valve, rollout switches, primary limit switch and make-up box then disconnect them.
- 3 - Disconnect gas supply piping. Remove the four screws securing the burner manifold assembly to the vestibule panel and remove the assembly from the unit.
- 4 - Remove 4 screws securing burner box and remove burner box.
- 5 - To clean burners, run a vacuum cleaner with a soft brush attachment over the face of burners. Visually inspect inside the burners and crossovers for any blockage caused by foreign matter. Remove any blockage.
- 6 - Reinstall burner box, manifold assembly and burner box cover.
- 7 - 8- Reconnect all wires.

- 8 - Reconnect gas supply piping.
- 9 - Turn on power and gas supply to unit.
- 10 - Set thermostat and check for proper operation.
- 11 - Check all piping connections, factory and field, for gas leaks. Use a leak detecting solution or other preferred means.

CAUTION

Some soaps used for leak detection are corrosive to certain metals. Carefully rinse piping thoroughly after leak test has been completed. Do not use matches, candles, flame or other sources of ignition to check for gas leaks.

- 12 - If a leak is detected, shut gas and electricity off and repair leak.
- 13 - Repeat steps 12 and 13 until no leaks are detected.
- 14 - 15- Replace access panel.

Repair Parts List

The following repair parts are available through independent Lennox dealers. When ordering parts, include the complete furnace model number listed on the CSA International nameplate -- Example: SL280DF070V36A. **All service must be performed by a licensed professional installer (or equivalent), service agency, or gas supplier.**

Cabinet Parts

- Upper access panel
- Blower panel
- Top cap

Control Panel Parts

- Transformer
- Two-stage, variable speed integrated control
- Door interlock switch
- Circuit breaker

Blower Parts

- Blower wheel
- Blower housing
- Motor
- Motor electronics
- Power choke (1 hp only)
- Motor mounting frame
- Blower housing cutoff plate

Heating Parts

- Flame Sensor
- Heat exchanger assembly
- Gas manifold
- Two-speed combustion air inducer
- Two-stage gas valve
- Main burner cluster
- Main burner orifices
- Pressure switch
- Ignitor
- Primary limit control
- Flame rollout switch
- Secondary limit

Integrated Control Diagnostic Modes	
Display	Action (when button is released)
No change (idle)*	Remain in idle mode
Solid "E"	Enter diagnostic recall mode
Solid "U"	Discharge Air Installed
Solid "F"	Enter flame signal mode
Solid "F" (variable speed only)	Program unit capacity size (Unit Code)
Two horizontal lines	soft disable

* No change implies the display will continue to show whatever is currently being displayed for normal operation (blinking decimal, active error code, heat state, etc..)

Diagnostic LED (Figure 33)

The seven-segment diagnostic LED displays operating status, target airflow, error codes and other information. The table beginning on the next page lists diagnostic LED codes.

Diagnostic Push Button (Figure 33)

The diagnostic push button is located adjacent to the seven-segment diagnostic LED. This button is used to enable the Error Code Recall "E" mode and the Flame Signal "F" mode. Press the button and hold it to cycle through a menu of options. Every five seconds a new menu item will be displayed. When the button is released, the displayed item will be selected. Once all items in the menu have been displayed, the menu resumes from the beginning until the button is released.

Error Code Recall Mode

Select "E" from the menu to access the most recent 10 error codes. Select "c" from the Error Code Recall menu to clear all error codes. Button must be pressed a second time while "c" is flashing to confirm command to delete codes. Press the button until a solid "≡" is displayed to exit the Error Code Recall mode.

Flame Signal Mode

Select "F" from the menu to access the flame signal mode. The integrated control will display the flame current on 7 segment LED in micro amps (uA).

Flame signal mode is exited after any of the following:

- Power is reset
- Pressing and holding push button until 3 horizontal lines "≡" are displayed
- 10 minutes after entering the flame sense mode.

Program Unit Capacity/Size Mode

After the "P" is selected (by releasing the push button) the integrated control will start flashing the "P" on display for 90 seconds. If push button is pressed again and held during that time, the control will start to display characters corresponding to different variable speed furnace models for 3 seconds each. While the wanted character-model is displayed push button has to be released. Selected option will flash display for 10 seconds and during that time push button has to be pressed and held for 5 seconds. Once control accepts new setting it will store data in non-volatile memory and reset itself. If 10 seconds expires or push button is held less than 5 seconds, control will exit field test mode and go into idle without changing programming the unit size.

Soft Disable

Soft disabling is when thermostat finds a device on the BUS that it does not recognize and the thermostat sends a the device a message to be in soft disabling mode until properly configured. Two horizontal bars will display.

Steps to follow if the damper control module is displaying the soft disable code.

- 1 - Confirm proper wiring between all devices (thermostat, damper control module, indoor and outdoor).
- 2 - Cycle power to the control that is displaying the soft disable code.
- 3 - Put the room thermostat through set up.
- 4 - Go to setup / system devices / thermostat / edit / then push reset.
- 5 - Go to setup / system devices / thermostat / edit / then push reset All.

Integrated Control Diagnostic Codes

Code	Diagnostic Codes/Status of Equipment	Action Required to Clear and Recover
.	Idle mode (Decimal blinks at 1 Hertz -- 0.5 second ON, 0.5 second OFF).	
A	Cubic feet per minute (cfm) setting for indoor blower (1 second ON, 0.5 second OFF) / cfm setting for current mode displayed.	
C	Cooling stage (1 second ON, 0.5 second OFF) / 1 or 2 displayed / Pause / cfm setting displayed / Pause / Repeat codes).	
d	Dehumidification mode (1 second ON) / 1 second OFF) / cfm setting displayed / Pause / Repeat Codes).	
h	Heat pump stage (1 second ON, 0.5 second OFF) / % of input rate displayed / Pause / cfm setting / Pause / Repeat codes.	
H	Gas Heat Stage (1 second ON, 0.5 second OFF) / 1 or 2 displayed / Pause / cfm setting displayed / Pause / Repeat codes. Blinking during ignition.	
dF	Defrost mode.	
U	Discharge Air Temperature	
E000	No error in memory	
E105	Device communication problem - No other devices on RS BUS (Communication system).	
E110	Low line voltage.	Line Voltage Low (Voltage lower than nameplate rating). Check power line voltage and correct. Alarm clears 5 seconds after fault recovered.
E111	Low line voltage.	Reverse line power voltage wiring. System resumes normal operation 5 seconds after fault recovered.
E112	Ground not detected	System shuts down. Provide proper earth ground. System resumes normal operation 5 seconds after fault recovered.
E113	High line voltage.	Line Voltage High (Voltage higher than nameplate rating). Provide power voltage within proper range. System resumes normal operation 5 seconds after fault recovered.
E114	Line voltage frequency out-of-range.	No 60 Hertz Power. Check voltage and line power frequency. Correct voltage and frequency problems. System resumes normal operation 5 seconds after fault recovered.
E115	Low 24V - Control will restart if the error recovers.	24-Volt Power Low (Range is 18 to 30 volts). Check and correct voltage. Check for additional power-robbing equipment connected to system. May require installation of larger VA transformer to be installed in furnace / air handler. Clears after fault recovered.
E117	Poor ground detected (Warning only)	Provide proper grounding for unit. Check for proper earth ground to the system. Warning only will clear 30 seconds after fault recovered.
E120	Unresponsive device. Communication only.	Usually caused by delay in outdoor unit responding to indoor unit polling. Recycle power. Check all wiring connections. Cleared after unresponsive device responds to any inquiry.

Integrated Control Diagnostic Codes

Code	Diagnostic Codes/Status of Equipment	Action Required to Clear and Recover
E124	Active communicating thermostat signal missing for more than 3 minutes.	Equipment lost communication with the thermostat. Check four wiring connections, ohm wires and cycle power at the thermostat. Alert stops all services and waits for heartbeat message from thermostat (subnet controller). Cleared after valid thermostat (subnet controller) message is received.
E125	Control failed self-check, internal error, failed hardware. Will restart if error recovers. Integrated control not communicating. Covers hardware errors (flame sense circuit faults, pin shorts, etc.).	Hardware problem on the control. Cycle power on control. Replace if problem prevents service and is persistent. Critical alert. Cleared 300 seconds after fault recovered.
E131	Corrupted control parameters (Verify configuration of system). Communicating only.	Reconfigure the system. Replace control if heating or cooling is not available. Only applicable in the communicating mode, not in startup. Exit from Commissioning and Execute 'Set Factory Default mode Control will still operate on default parameter settings
E150	A2L Refigerant leak alarm	
E151	A2L Sensor fault (sensor problem) (communication mode only)	
E180	Outdoor air temperature sensor failure. Only shown if shorted or out-of-range.	Compare outdoor sensor resistance to temperature/ resistance charts in unit installation instructions. Replace sensor pack if necessary. At beginning of (any) configuration, furnace or air handler control will sense outdoor air and discharge air temperature sensor(s). If detected (reading in range), appropriate feature will be set as 'installed' and that could be seen in 'About' screen. In normal operation after control recognizes sensors, alarm will be sent if valid temperature reading is lost. To get rid of setting and alarm, redo configuration and make sure that temperature sensor is marked as 'not installed' in Indoor Unit 'About' screen. When Indoor unit control is replaced, thermostat will 'tell' new control if temperature sensor is in system or not. Clears 30 seconds after fault recovered.
E200	Hard lockout - Rollout circuit open or previously open.	Correct cause of rollout trip, or replace flame rollout switch. Test furnace operation. Cleared after fault recovered.
E201	Indoor blower communication failure - Unable to communicate with blower motor.	Indoor blower communication failure (including power outage). Lost communication with indoor blower motor. Possible causes: motor not powered, loose wiring. Problem may be on control or motor side. Cleared after fault recovered.
E202	Indoor blower motor mis-match - Indoor motor horsepower does not match unit capacity.	Incorrect appliance capacity code selected. Check for proper configuring under: Unit Size Codes for Furnace/Air Handler on configuration guide or in installation instructions. Cleared after the correct match is detected following a reset. (Remove thermostat from system while applying power and reprogramming.)
E203	Appliance capacity / size is NOT programmed. Invalid unit codes refer to configuration flow chart.	No appliance capacity code selected. Check for proper configuring under: Unit Size Codes for Furnace on configuration guide or in installation instructions. Critical Alert. Cleared after valid unit code is read following a reset. (Remove thermostat from system while applying power and reprogramming.)
E204	Gas valve mis-wired.	Check gas valve operation and wiring. Clears when repaired.
E205	Gas valve control relay contact shorted.	Check wiring on control and gas valve. If wiring is correct, replace control.

Integrated Control Diagnostic Codes

Code	Diagnostic Codes/Status of Equipment	Action Required to Clear and Recover
E206	Gas valve second-stage relay failure	Furnace will operate on 1st stage for remainder of the heating demand. Will clear after fault recovered. If unable to operate 2nd stage, replace control.
E207	Hot surface ignitor sensed open.	Measure resistance of hot surface ignitor. Replace if open or not within specified range found in IOM. Resumes normal operation after fault is cleared.
E223	Low pressure switch failed open.	Check pressure (inches w.c.) of low pressure switch closing on heat call. Measure operating pressure (inches w.c.). Inspect vent and combustion air inducer for correct operation and restriction. Resumes normal operation after fault is cleared
E224	Low pressure switch failed closed.	Check operation of low pressure switch to see if it is stuck closed on heat call longer than 150 seconds. Measure operating pressure (inches w.c.). Inspect vent and combustion air inducer for correct operation and restriction. Resumes normal operation after fault is cleared.
E225	High pressure switch failed open.	Check pressure (inches w.c.) of high pressure switch closing on heat call. Measure operating pressure (inches w.c.). Inspect vent and combustion air inducer for correct operation and restriction. Resumes normal operation after fault is cleared.
E226	High pressure switch failed closed	Check operation of high pressure switch closing on heat call. Measure operating pressure (inches w.c.). Inspect vent and combustion air inducer for correct operation and restriction. Resumes normal operation after fault is cleared.
E227	Low pressure switch open during trial for ignition or run mode.	Check pressure (inches w.c.) of low pressure switch closing on heat call. Measure operating pressure (inches w.c.). Inspect vent and combustion air inducer for correct operation and restriction. Resumes normal operation after fault is cleared.
E228	Combustion air inducer calibration failure	Unable to perform pressure switch calibration. Check vent system and pressure switch wiring connections. Resumes normal operation after fault is cleared.
E229	Ignition on high fire	IFC switched to high fire ignition because low fire pressure switch did not close in allowed time. No action is needed.
E240	Low flame current - Run mode.	Check micro-amperes of flame sensor using control diagnostics or field-installed mode. Clean or replace sensor. Measure voltage of neutral to ground to ensure good unit ground. Alert clears after current heat call has been completed.
E241	Flame sensed out of sequence - Flame still present.	Shut off gas. Check for gas valve leak. Replace, if necessary. Alert clears when fault is recovered.
E250	Limit switch circuit open.	Check for proper firing rate on furnace. Ensure there is no blockage in heater. Check for proper air flow. If limit not closed within 3 minutes, unit will go into 1-hour soft lockout. Resumes normal operation after fault is cleared.
E252	Discharge air temperature too high (gas heat only).	Check temperature rise, air flow and input rate. Cleared when heat call is finished.
E270	Soft lockout - Exceeded maximum number of retries. No flame current sensed.	Check for proper gas flow. Ensure that ignitor is lighting burner. Check flame sensor current. Clears when heat call finishes successfully.

Integrated Control Diagnostic Codes

Code	Diagnostic Codes/Status of Equipment	Action Required to Clear and Recover
E271	Soft lockout - Exceeded maximum number of retries. Last retry failed due to the pressure switch opening.	Check pressure (inches w.c.) of low pressure switch closing on heat call. Measure operating pressure (inches w.c.). Inspect vent and combustion air inducer for correct operation and restriction. Clears when heat call finishes successfully.
E272	Soft lockout - Exceeded maximum number of recycles. Last recycle due to the pressure switch opening.	Check operation of low pressure switch to see if it is stuck closed on heat call. Check pressure (inches w.c.) of high pressure switch closing on heat call. Measure operating pressure (inches w.c.). Inspect vent and combustion air inducer for correct operation and restriction. Clears when heat call finishes successfully.
E273	Soft lockout - Exceeded maximum number of recycles. Last recycle due to flame failure.	Check micro-amperes of flame sensor using control diagnostics or field-installed mode. Clean or replace sensor. Measure voltage of neutral to ground to ensure good unit ground. Clears when heat call finishes successfully.
E274	Soft lockout - Exceeded maximum number of recycles. Last recycle failed due to the limit circuit opening or limit remained open longer than 3 minutes	Shut down system. 1-hour soft lockout. Check firing rate and air flow. Check for blockage. Clears when heat call finishes successfully.
E275	Soft lockout - Flame sensed out of sequence. Flame signal is gone.	Shut off gas. Check for gas valve leak. 1-hour soft lockout. Clears when flame has been proven stable.
E290	Ignitor circuit fault - Failed ignitor or triggering circuitry.	Measure resistance of hot surface ignitor. Replace if open or not within specifications. 1-hour soft lockout. Clears when flame has been proven stable.
E292	Indoor blower motor unable to start due to obstructed wheel, seized bearings.	Indoor blower motor unable to start (seized bearing, stuck wheel, etc.). Replace motor or wheel if assembly does not operate or meet performance standards. 1-hour soft lockout. Clears after circulator successfully starts.
E295	Indoor blower motor temperature is too high.	Indoor blower motor over temperature (motor tripped on internal protector). Check motor bearings and amps. Replace if necessary. Cleared after blower demand is satisfied.
E310	Discharge error temperature sensor failure. Only shown if shorted or out of range.	Compare outdoor sensor resistance to temperature/ resistance charts in installation instructions. Replace sensor if necessary. Cleared in Communicating mode: 30 seconds after fault recovered. In Non-Communicating mode: Cleared after the current heat call is completed.
E311	Heat rate reduced to match indoor blower air flow.	Warning Only. Furnace blower in cutback mode due to restricted airflow. Reduce firing rate every 60 seconds to match available CFM. Check filter and duct system. To clear, replace filter if needed or repair/ add duct. 2-stage controls will reduce firing rate to 1st stage. Clears when heat call finishes successfully.

Integrated Control Diagnostic Codes

Code	Diagnostic Codes/Status of Equipment	Action Required to Clear and Recover
E312	Restricted air flow in cooling or continuous fan mode is lower than cfm setting.	Warning Only. Restricted airflow - Indoor blower is running at a reduced CFM (Cutback Mode - The variable speed motor has pre-set speed and torque limiters to protect the motor from damage caused by operating outside of design parameters (0 to 0.8" W.C.. total external static pressure). Check filter and duct system. To clear, replace filter if needed or repair/add duct. Cleared after the current service demand is satisfied.
E313	Indoor or outdoor unit capacity mismatch. Communication only.	Incorrect indoor/outdoor capacity code selected. Check for proper configuring in installation instructions. Alarm is just a warning. The system will operate, but might not meet efficiency and capacity parameters. Alarm will clear when commissioning is exited. Cleared after commissioning is complete.
E334	Relay "Y1" stuck on interated control.	Replace integrated control.
E345	Relay O Failure	
E347	No 24 Volt output on Y1 of "integrated control" with non communicating outdoor unit.	Operation stopped. Y1 relay / Stage 1 failed. (Pilot relay contacts did not close or the relay coil did not energize; no input back to IFC chip). Critical Alert. Cleared after reset and Y1 input sensed.
E348	No 24 Volt output on Y2 of "integrated control" with non?communicating outdoor unit.	Y2 relay / Stage 2 failed. (Pilot relay contacts did not close or the relay coil did not energize; no input back to IFC chip). Critical Alert. Cleared after reset and Y1 input sensed.
E370	Interlock switch sensed open for 2 minutes.	Control sees the loss of 24VAC for 2 minutes. Terminate all services and wait for interlock switch to close. The alarm will clear when 24VAC is continuously sensed on DS terminal for a minimum of 10 seconds or on a power reset.

Troubleshooting: Heating Sequence of Operation

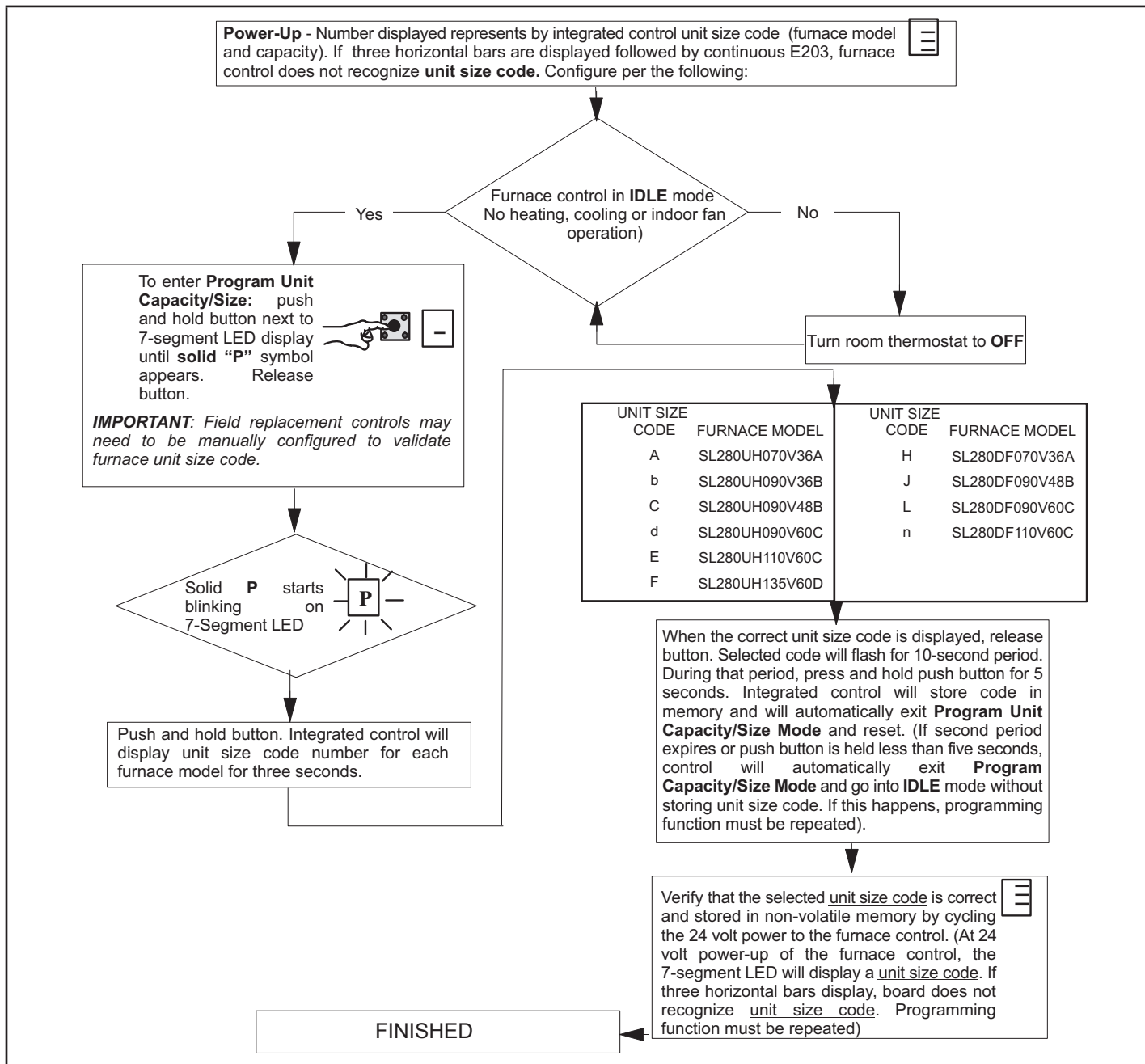

CALL FOR FIRST-STAGE HEAT

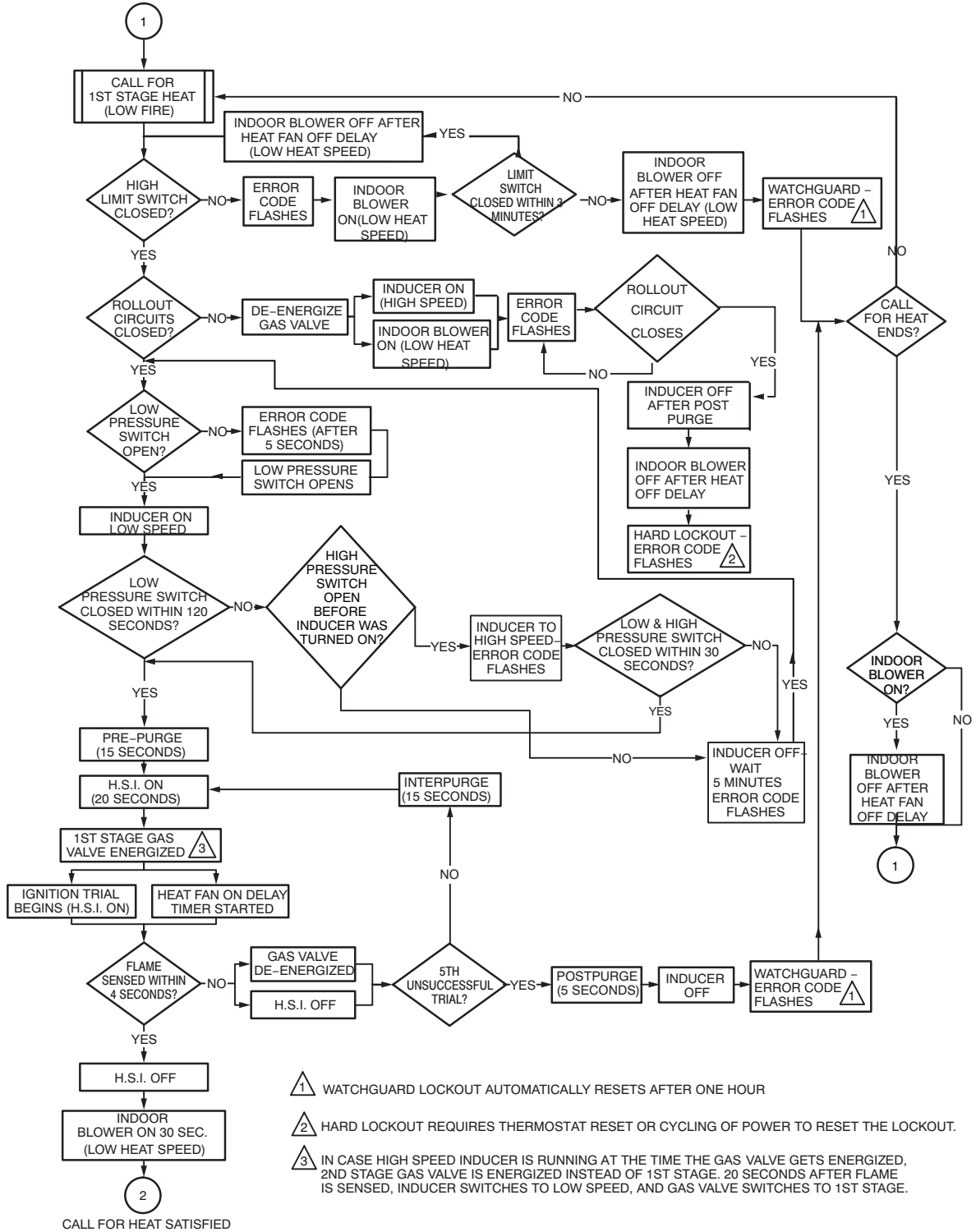

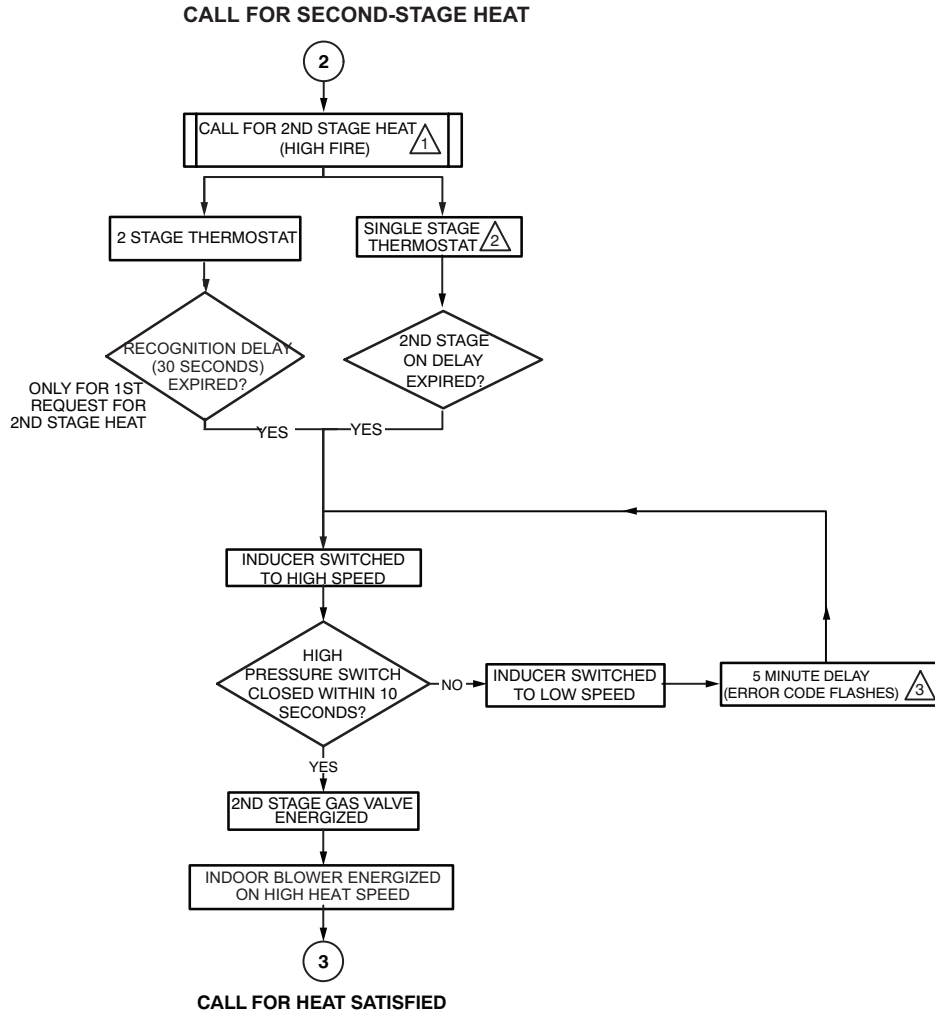

- 1 SYSTEM WILL ALWAYS LIGHT ON LOW FIRE, EVEN IF 2ND STAGE HEAT IS IN PLACE.
- 2 WHEN USED WITH A SINGLE STAGE THERMOSTAT, SET SW1 TO THE ON POSITION IN DIP SWITCH S4.
- 3 IF THE HIGH FIRE PRESSURE SWITCH DOES NOT CLOSE WITHIN 5 ATTEMPTS, THE SYSTEM WILL OPERATE AT LOW FIRE FOR THE REMAINDER OF THE CALL FOR HEAT REQUEST.

Troubleshooting: Heating Sequence of Operation (Continued)

CALL FOR HEAT SATISFIED

FIRST-STAGE HEAT SECOND-STAGE HEAT

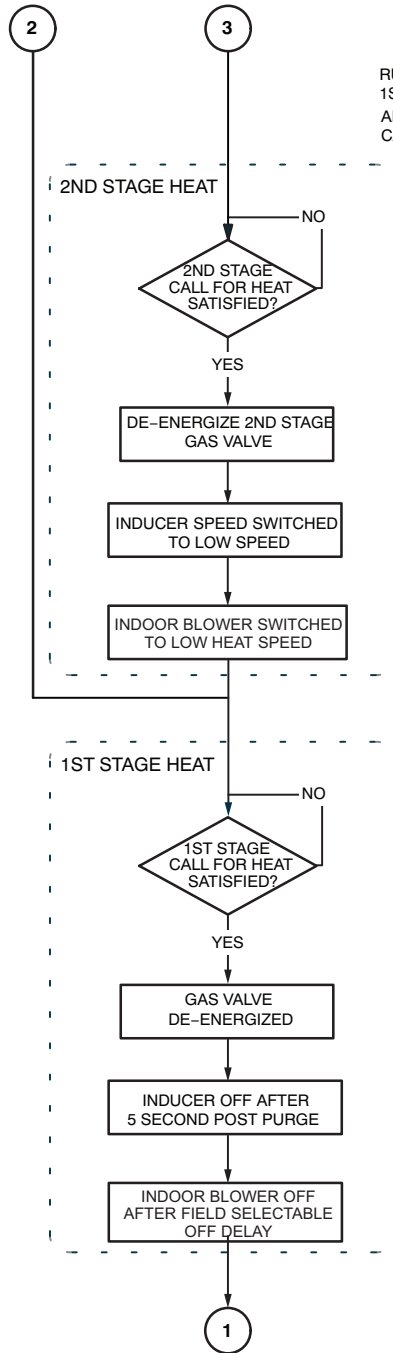

RUN MODE:
1ST OR 2ND STAGE CALL FOR HEAT.
ALL INPUTS MONITORED (LIMIT, PRESSURE,
CALL FOR HEAT/COOL, FLAME LEVEL)

Troubleshooting: Cooling Sequence of Operation

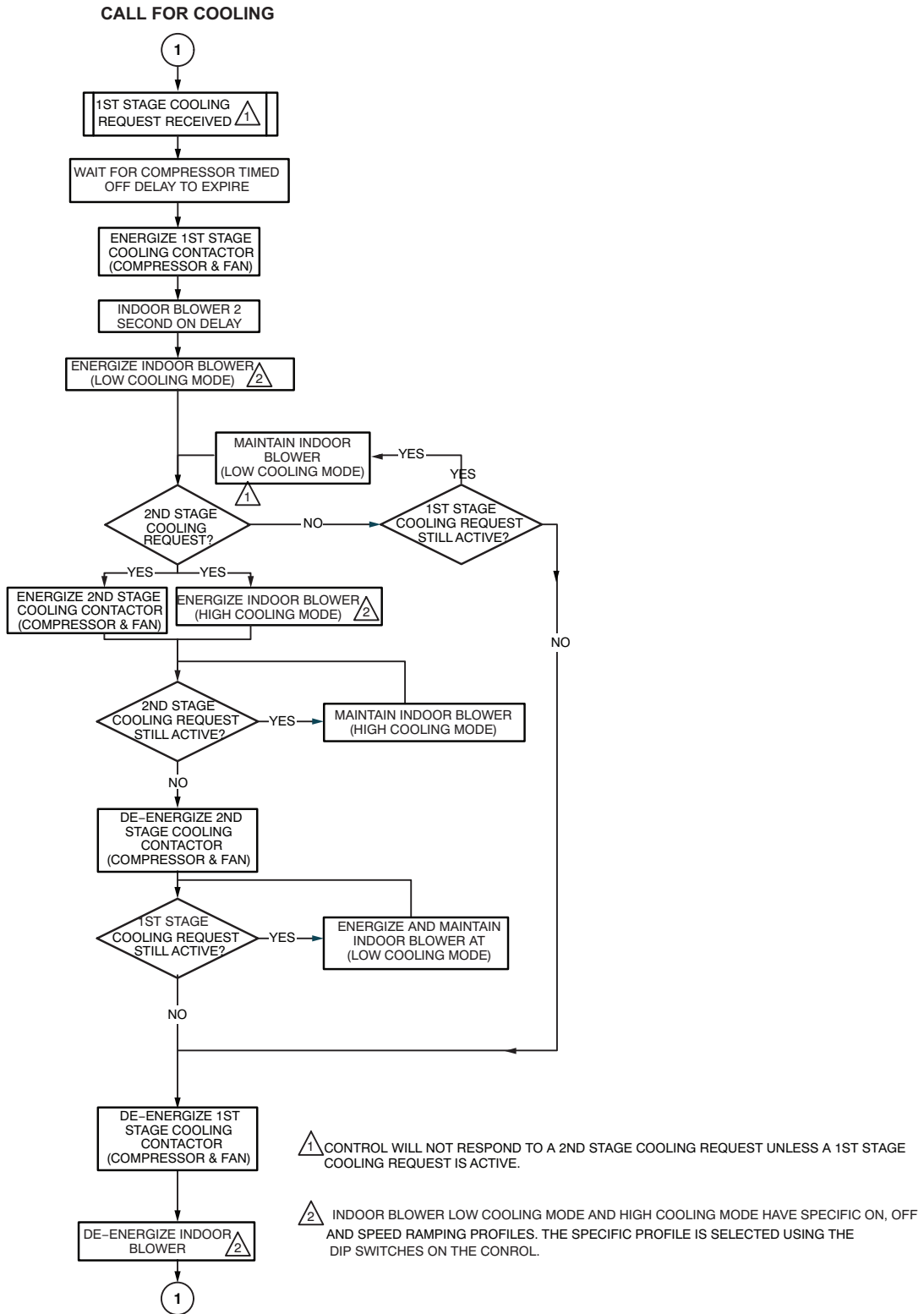

Troubleshooting: Continuous Fan Sequence of Operation

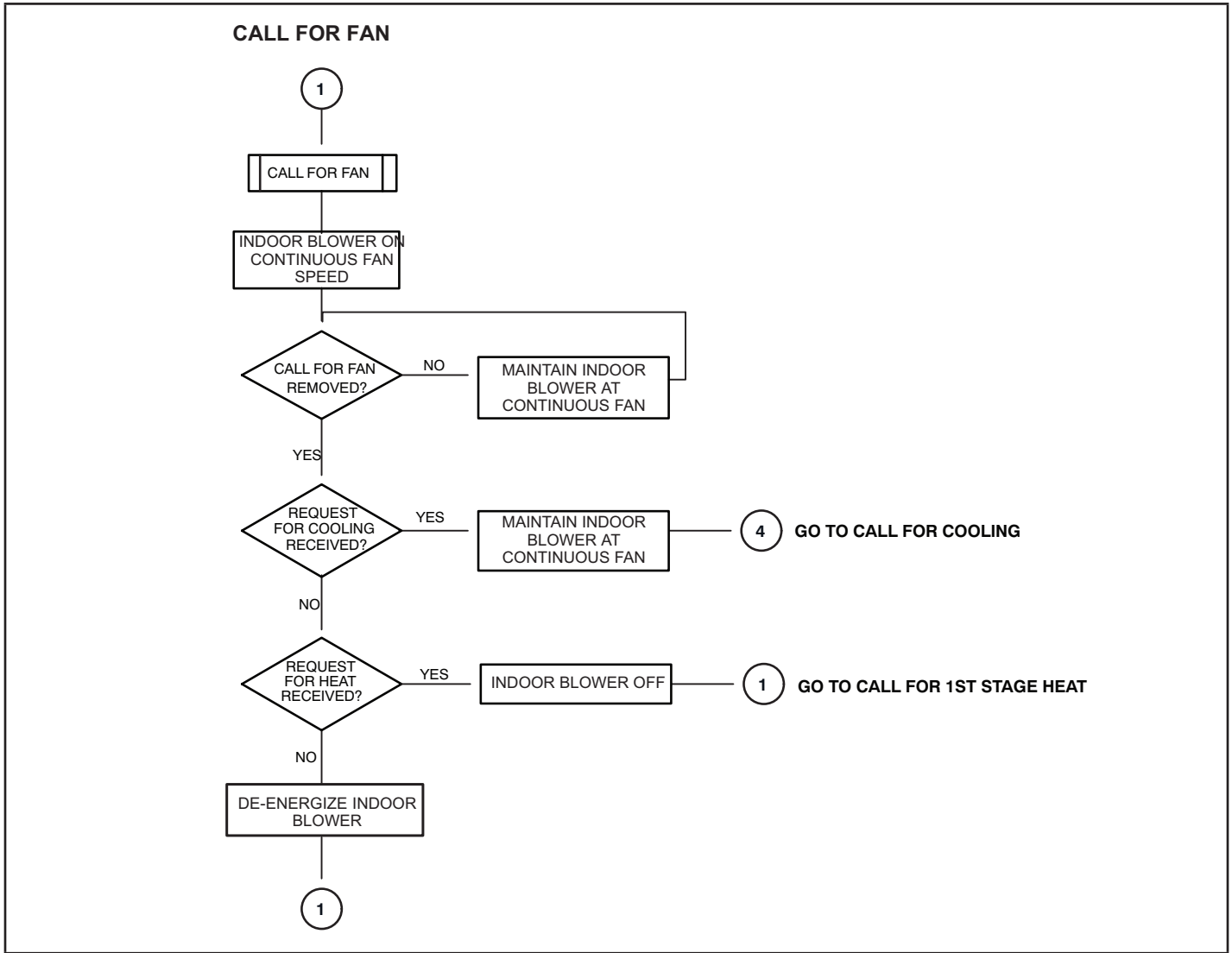

TABLE 24

Allowable Heating Speeds								
Model Number	-18%	-12%	-6%	Default	+6%	+12%	+18%	+24%
All Models	Allowed	Allowed	Allowed	Factory Setting	Allowed	Allowed	Allowed	Allowed

TABLE 25

Allowable Circulation Speeds		
Model Number	28% (second stage cool)	38% (second stage cool)
All Models	Allowed	Factory Setting