

VARIABLE REFRIGERANT FLOW SYSTEMS



VRF V33B

High Efficiency 360° Cassette Indoor Models - 60HZ

Bulletin No. 210710
July 2018
Supersedes March 2018

PRODUCT SPECIFICATIONS

Low-sound, high efficiency cassette, encased in galvanized steel offers 360° airflow for immediate, equal distribution of wide-range cooling and heating. Cassette has motor-driven dual swing louvers and installs in standard ceilings.



CONTENTS

Air Throw Data	8
Cooling Capacity	10
Dimensions	4
Heating Capacity	14
Installation Clearances	5
Model Number Identification	1
Sound Data	6
Specifications	2

APPROVALS

- Units are ETL certified for the U.S. and Canada.

WARRANTY

- **Components** - Limited ten years for qualifying installations. See Warranty Certificate for details.

FEATURES

- **360° Airflow Panel** - Allows for even, wide-range cooling and heating.
- **Pre-Heat Function** - Delays the operation of the fan until the indoor coil has reached a pre-determined temperature which prevents the discharge of cold air while the system is operating in the “heating” mode.
- **LED Readout/Infrared Receiver Panel** - Mounted on unit. LEDs display unit operation status, and codes for maintenance and servicing. Infrared receiver for use with a wireless remote control (not furnished).



- **Unit Addressing (Heat Pump Systems Only)** - An optional wireless remote control (not furnished) can be used to inquire and modify each indoor unit’s address.
- **Auto Restart** - Automatically restores the previous function setting if power is interrupted.
- **Built-In Condensate Pump** - Maximum lift - 28 inch lift.
- **Electronic Expansion Valve** - Assures optimal performance throughout the application range.
- **Flare Connections** - Equipped with liquid and gas flare fittings for quick and secure piping.
- **Turbo Fan With Backward Curved Blades** - Reduces sound levels and air resistance.
- **Three-Stage Fan Speed** - Fan functions at three levels: low, medium, high.
- **Air Filter** - Cleanable air filter is furnished as standard.

MODEL NUMBER IDENTIFICATION

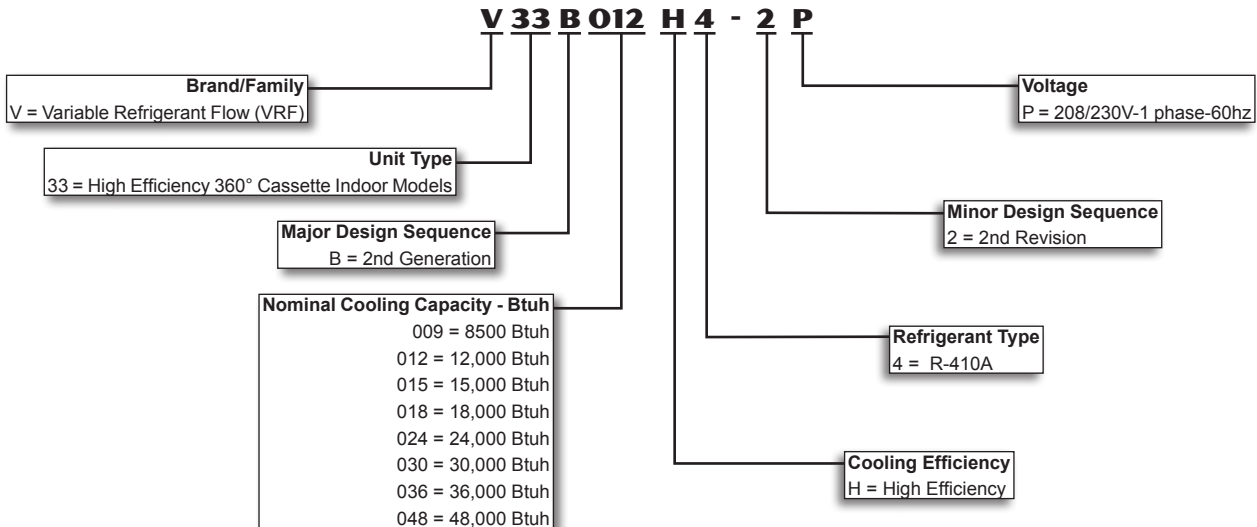

SPECIFICATIONS
009 - 018

General Data		Nominal kBtuh	9	12	15	18
		Model Number	V33B009H4	V33B012H4	V33B015H4	V33B018H4
		Efficiency	High	High	High	High
¹ Cooling Performance	Net Cooling Capacity - Btuh		8,500	12,000	15,000	18,000
	Total Unit Power Input (W)		29	39	59	59
	Rated current (A)		0.35	0.40	0.55	0.55
¹ Heating Performance	Net Heating Capacity - Btuh		10,900	13,600	17,000	21,000
	Total Unit Power Input (W)		22	33	52	83
	Rated current (A)		0.35	0.45	0.55	0.55
Refrigerant	Type		R-410A	R-410A	R-410A	R-410A
Indoor fan motor	Input - W		22	33	54	54
Indoor coil	Number of rows		2	2	3	3
	Fin spacing - in.		1/16	1/16	1/16	1/16
	Coil length x height x width - in.		79 x 6-5/8 x 1-1/2		79 x 10 x 1-1/2	
	Number of circuits		4	4	12	12
	Tube outside diameter and type - in.		1/4 - Rifled Copper Tubing			
	Fin type		Hydrophilic Coated Aluminum			
	Expansion device type		Electronic Expansion Valve			
	Design Pressure (high / low)- psig		650 / 250			
Indoor Coil Connections	Liquid pipe o.d. - in. (flare)		1/4	1/4	1/4	3/8
	Gas pipe o.d. - in. (flare)		1/2	1/2	1/2	5/8
	Drain connection o.d. - in.		(1) 1-1/4	(1) 1-1/4	(1) 1-1/4	(1) 1-1/4
Indoor Blower	Airflow (super high / high / medium / low) - cfm		460 / 390 / 330	560 / 460 / 390	800 / 680 / 560	800 / 680 / 560
	Sound data (high / medium / low) dBA		38 / 37 / 36	42 / 38 / 37	47 / 43 / 40	47 / 44 / 42
Control Wiring (AWG)		18/3 gauge (3-core shielded)				
Weight Data	Unit weight (net / shipping) - lbs.		54 / 71	54 / 71	69 / 86	69 / 86
	Diffuser Panel weight (net / shipping) - lbs.		11 / 18	11 / 18	11 / 18	11 / 18
ELECTRICAL DATA						
	Line voltage data - 60 hz - 1ph		208/230V	208/230V	208/230V	208/230V
	² Maximum overcurrent protection (amps)		15	15	15	15
	³ Minimum circuit ampacity		0.46	0.62	0.83	0.83
	Indoor Blower Motor - Full load amps		0.32	0.43	0.58	0.58

¹ Nominal capacities are based on the following conditions (with 25 ft. of connecting refrigerant lines);

- Cooling Ratings - 95°F outdoor air temperature and 80°F db/67°F wb entering indoor coil air.
- Heating Ratings - 47°F db/43°F wb outdoor air temperature and 70°F db entering indoor coil air.

² HACR type circuit breaker or fuse.

³ Refer to National or Canadian Electrical Code manual to determine wire, fuse and disconnect size requirements.

SPECIFICATIONS		024 - 048			
General Data	Nominal kBtuh	24	30	36	48
	Model Number	V33B024H4	V33B030H4	V33B036H4	V33B048H4
	Efficiency	High	High	High	High
¹ Cooling Performance	Net Cooling Capacity - Btuh	24,000	30,000	36,000	48,000
	Total Unit Power Input (W)	90	90	133	168
	Rated current (A)	0.80	0.80	1.10	1.35
¹ Heating Performance	Net Heating Capacity - Btuh	27,000	34,000	42,000	54,000
	Total Unit Power Input (W)	83	83	127	163
	Rated current (A)	0.80	0.80	1.10	1.40
Refrigerant	Type	R-410A	R-410A	R-410A	R-410A
Indoor fan motor	Input - W	88	88	133	165
Indoor coil	Number of rows	3	3	3	3
	Fin spacing - in.	1/16	1/16	1/16	1/16
	Coil length x height x width - in.	79 x 10 x 1-1/2	79 x 10 x 1-1/2	79 x 10 x 1-1/2	79 x 10 x 1-1/2
	Number of circuits	12	12	12	12
	Tube outside diameter and type - in.	1/4 - Rifled Copper Tubing			
	Fin type	Hydrophilic Coated Aluminum			
	Expansion device type	Electronic Expansion Valve			
	Design Pressure (high / low)- psig	650 / 250			
Indoor Coil Connections	Liquid pipe o.d. - in. (flare)	3/8	3/8	3/8	3/8
	Gas pipe o.d. - in. (flare)	5/8	5/8	5/8	5/8
	Drain connection o.d. - in.	(1) 1-1/4	(1) 1-1/4	(1) 1-1/4	(1) 1-1/4
Indoor Blower	Airflow (super high/high/medium/low) - cfm	950 / 800 / 680	950 / 800 / 680	1100 / 950 / 800	1200 / 1100 / 950
	Sound data (high / medium / low) dBA	51 / 47 / 44	51 / 47 / 44	54 / 51 / 47	56 / 54 / 50
Control Wiring (AWG)		18/3 gauge (3-core shielded)			
Weight Data	Unit weight (net / gross) - lbs.	69 / 86	69 / 86	69 / 86	69 / 86
	Diffuser Panel weight (net / gross) - lbs.	11 / 18	11 / 18	11 / 18	11 / 18
ELECTRICAL DATA					
	Line voltage data - 60 hz - 1ph	208/230V	208/230V	208/230V	208/230V
	² Maximum overcurrent protection (amps)	15	15	15	15
	³ Minimum circuit ampacity	1.3	1.3	1.8	2.2
	Indoor Blower Motor - Full load amps	0.86	0.86	1.22	1.49

¹ Nominal capacities are based on the following conditions (with 25 ft. of connecting refrigerant lines);

• Cooling Ratings - 95°F outdoor air temperature and 80°F db/67°F wb entering indoor coil air.

• Heating Ratings - 47°F db/43°F wb outdoor air temperature and 70°F db entering indoor coil air.

² HACR type circuit breaker or fuse.

³ Refer to National or Canadian Electrical Code manual to determine wire, fuse and disconnect size requirements.

DIMENSIONS - INCHES (MM)

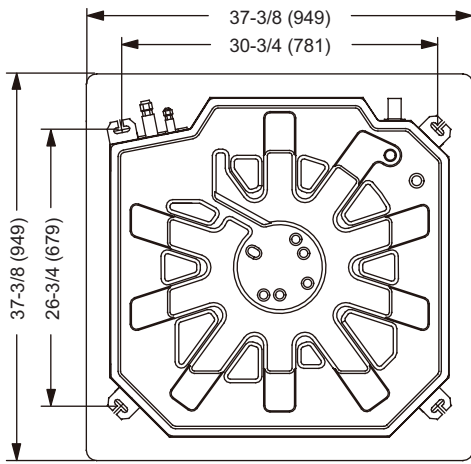

TOP VIEW

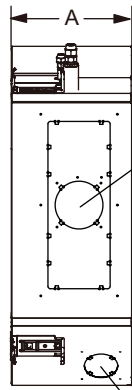

2-3/4 (70) dia.
FRESH AIR
INTAKE

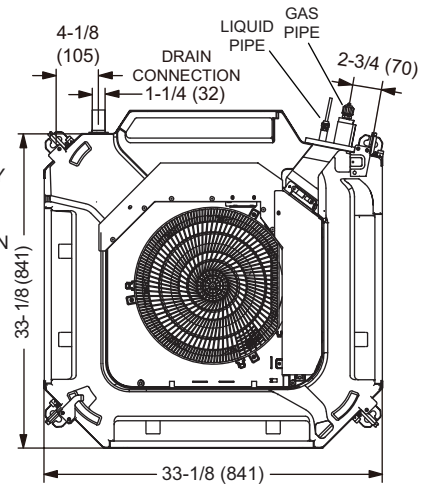

BOTTOM VIEW

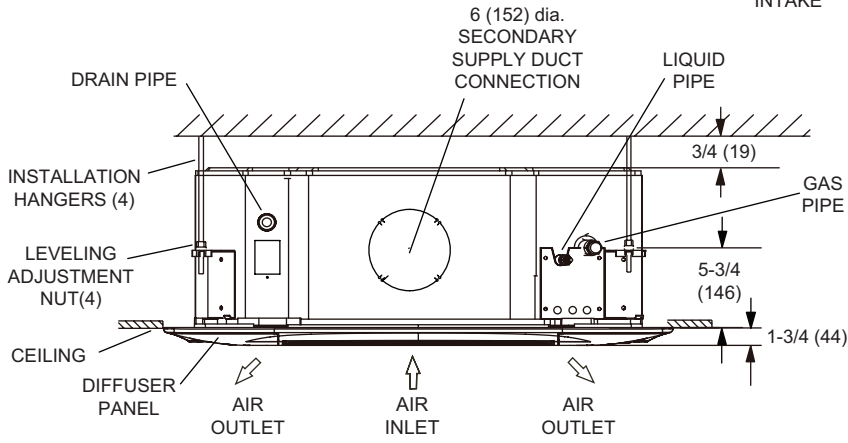

SIDE VIEW

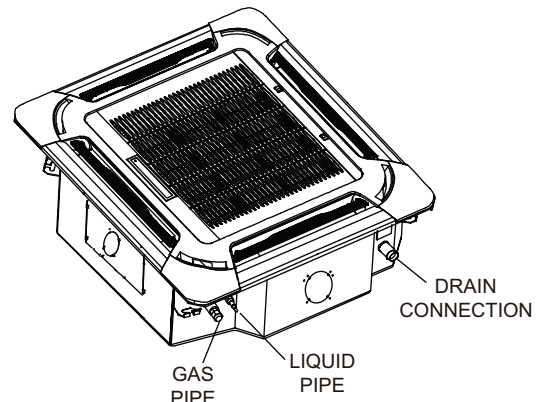

BOTTOM (PANEL) VIEW

Size	A	
	in.	mm
009, 012	9	229
015, 018, 024, 030, 036, 048	11-7/8	302

INSTALLATION CLEARANCES - INCHES (MM)

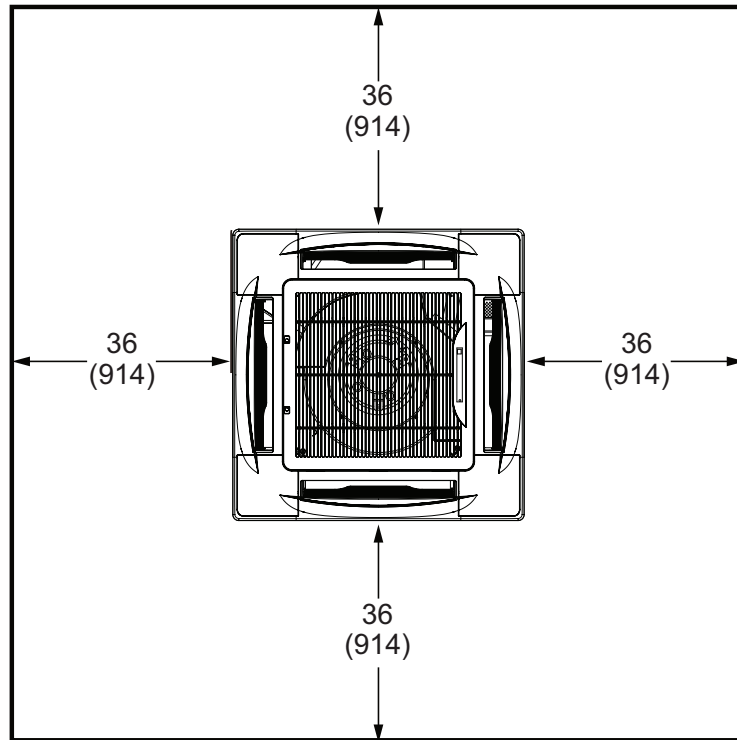

Minimum Vertical Clearances:

Minimum Clearance from Structural Ceiling to Drop Ceiling:

10-1/4 inches (260 mm) - 009, 012 models

13 inches (330 mm) - 015, 018, 024, 030, 036, 048 models

Minimum Clearance to Floor:

98-1/2 inches (2500 mm)

SOUND DATA

SOUND LEVELS

Model No.	Low	Medium	High
V33B009	36	37	38
V33B012	37	38	42
V33B015	40	43	47
V33B018	42	44	47
V33B024	44	47	51
V33B030	44	47	51
V33B036	47	51	54
V33B048	50	54	56

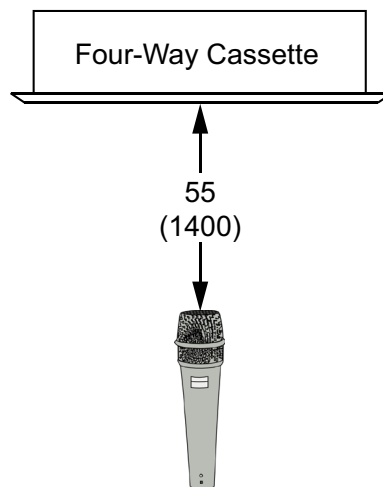

NOTE:

- Semi-anechoic chamber conversion value is measured at a point 55 inches (1400 mm) under the unit.

OCTAVE BAND LEVELS

V33B009H4

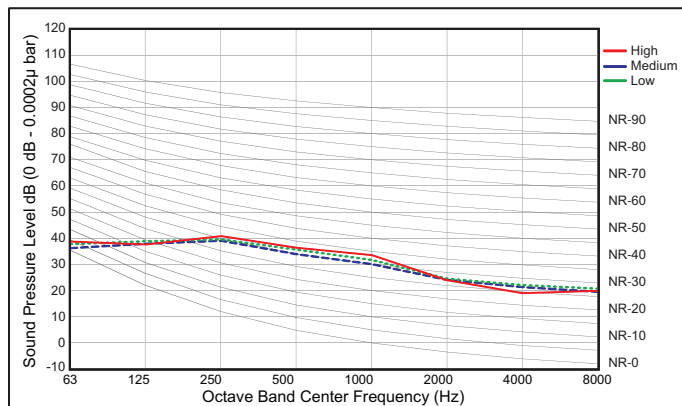

V33B015H4

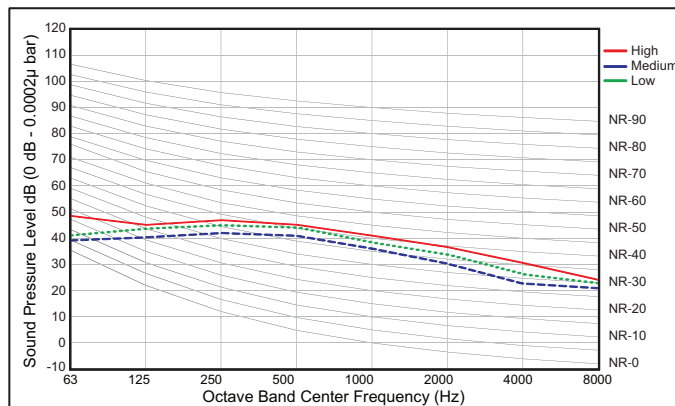

V33B012H4

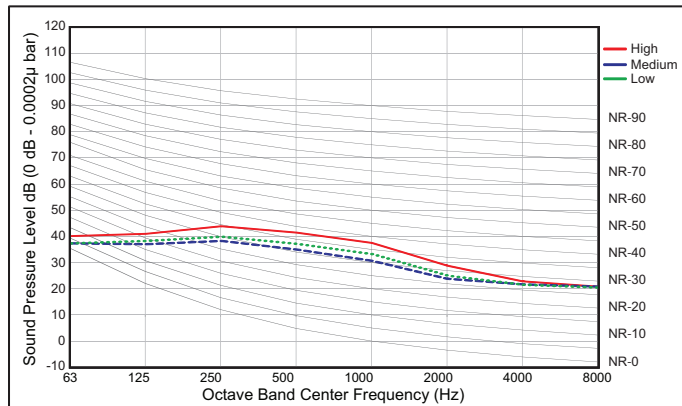

V33B018H4

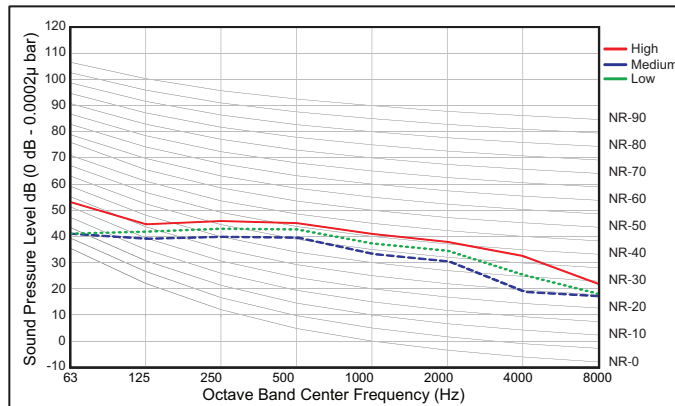

SOUND DATA

OCTAVE BAND LEVELS

V33B024H4

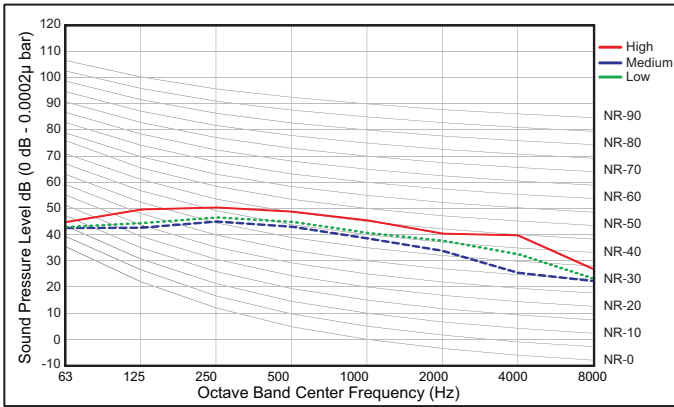

V33B036H4

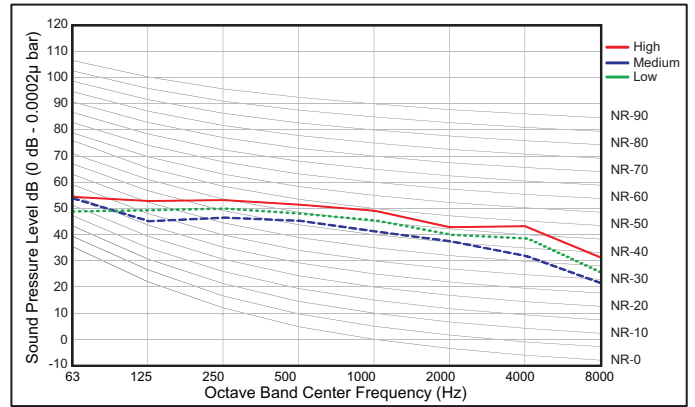

V33B030H4

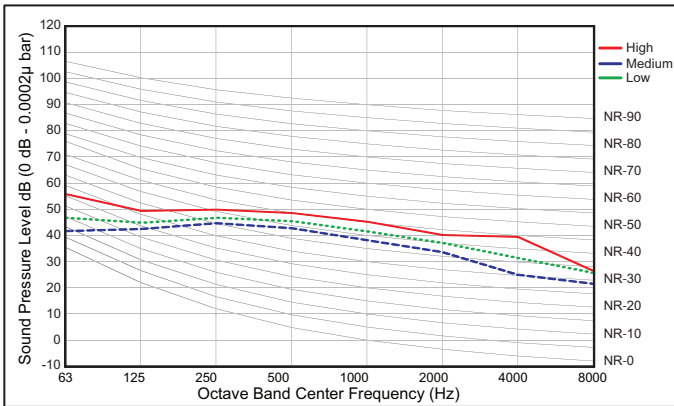

V33B048H4

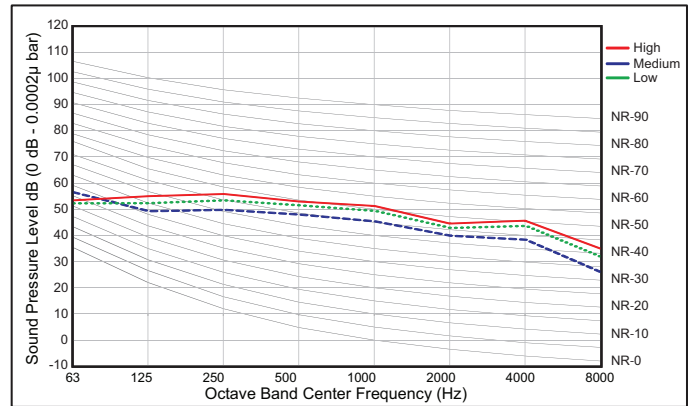

AIR THROW DATA

V33B009 - COOLING

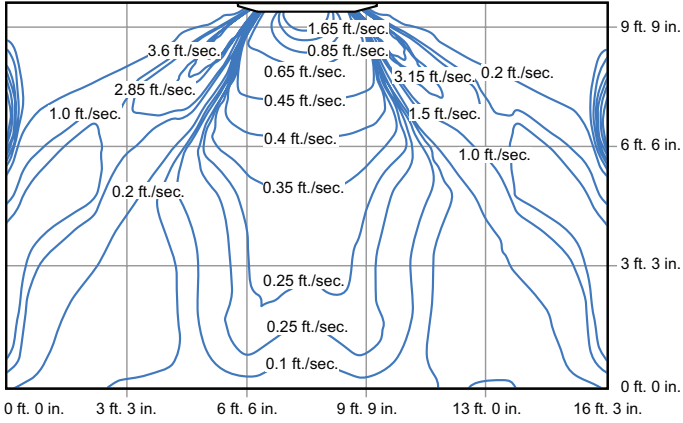

V33B009 - HEATING

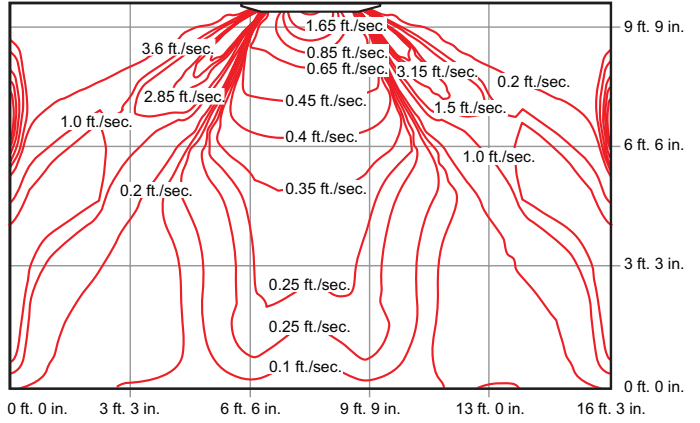

V33B012 - COOLING

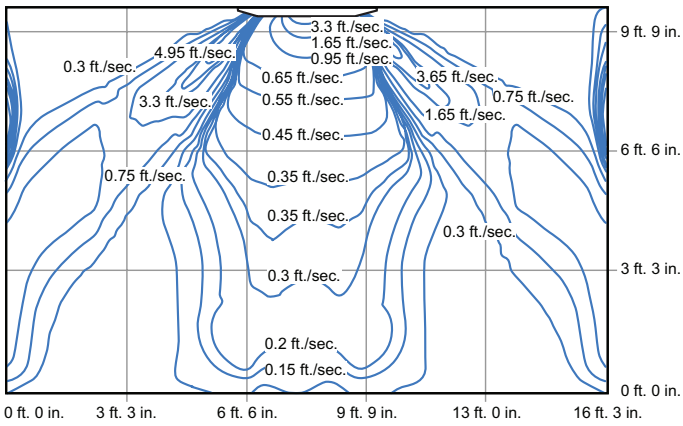

V33B012 - HEATING

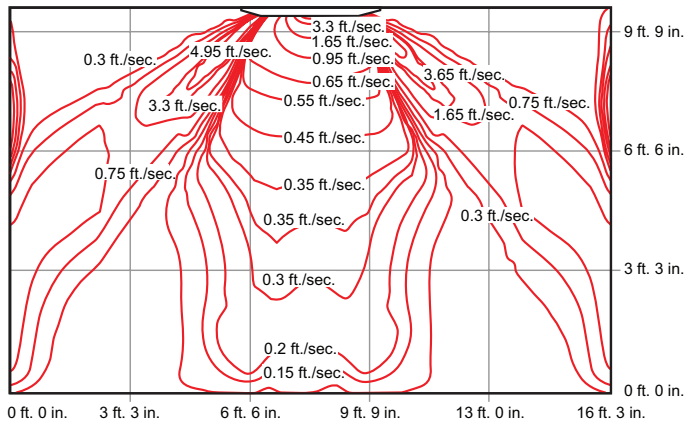

V33B015 - COOLING

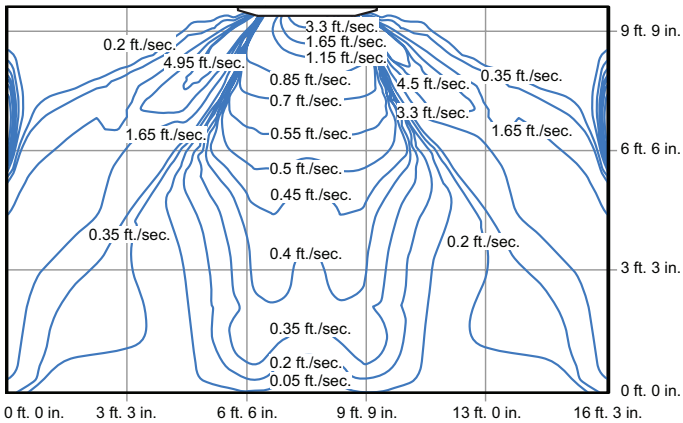

V33B015 - HEATING

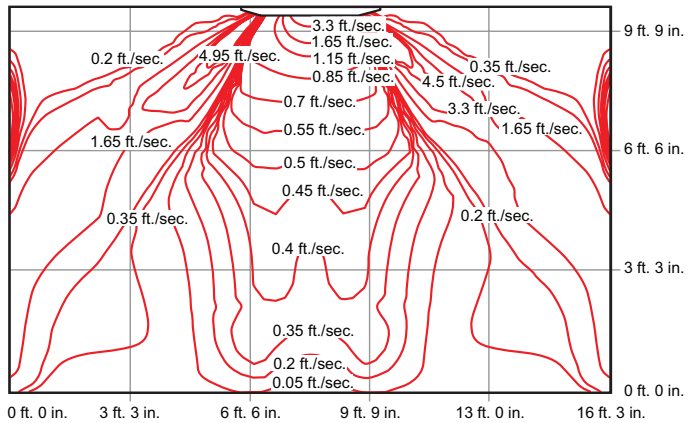

V33B018 - COOLING

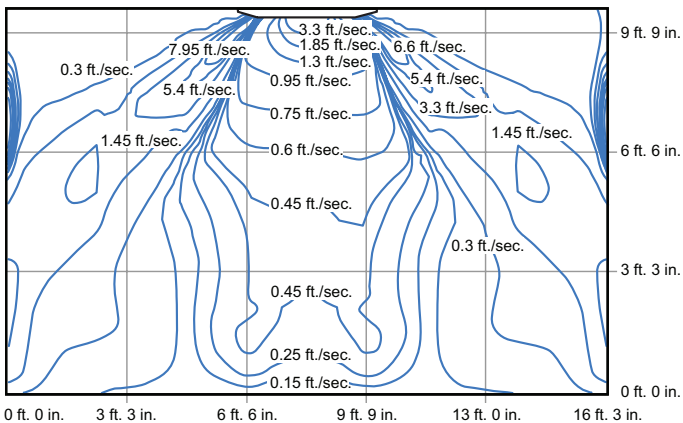

V33B018 - HEATING

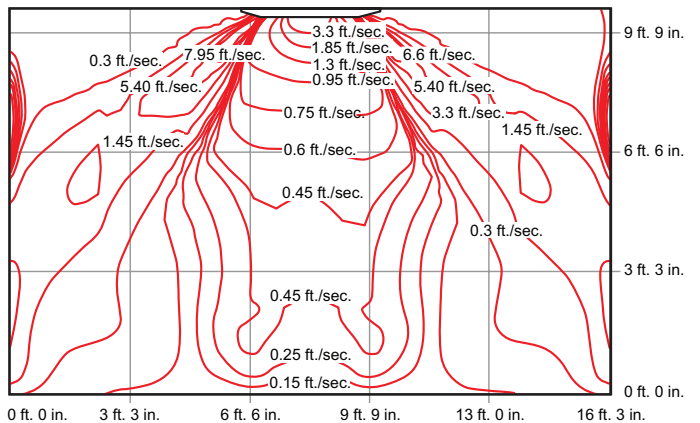

AIR THROW DATA

V33B024 - COOLING

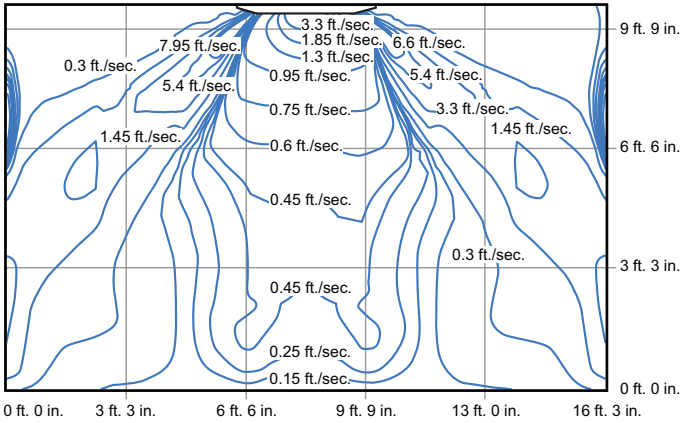

V33B024 - HEATING

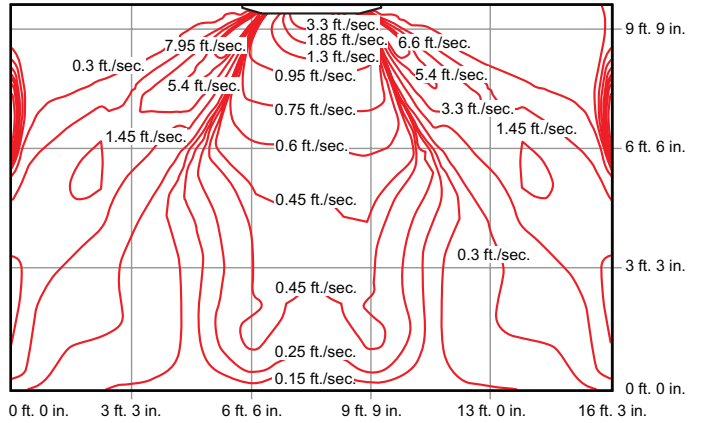

V33B030 - COOLING

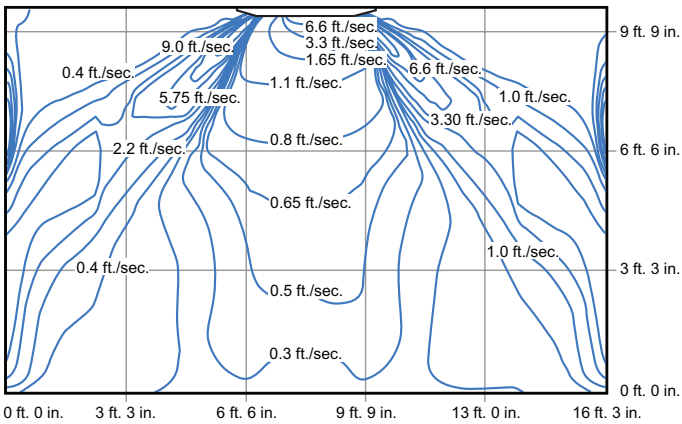

V33B030 - HEATING

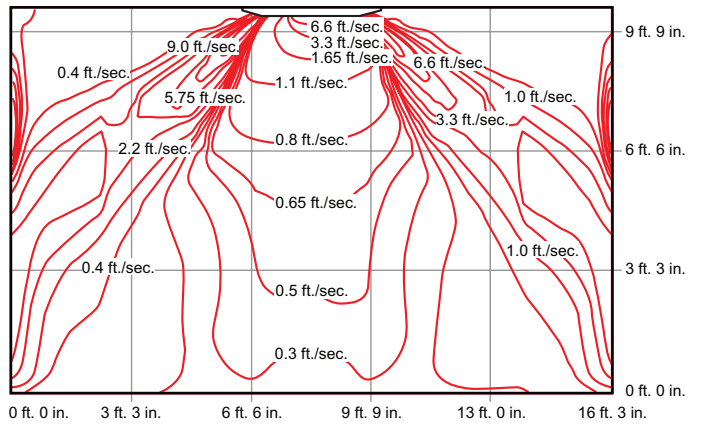

V33B036 - COOLING

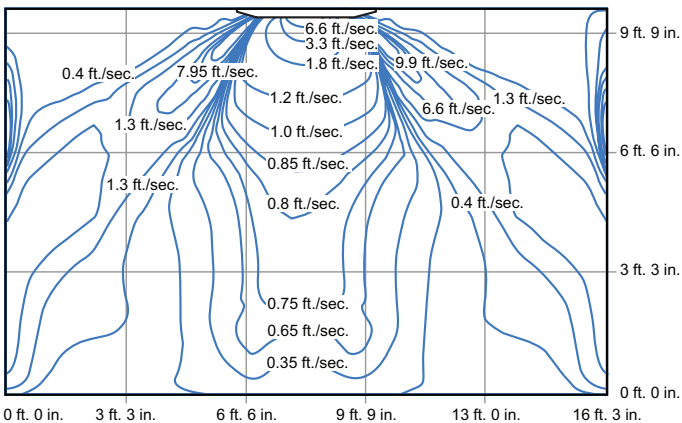

V33B036 - HEATING

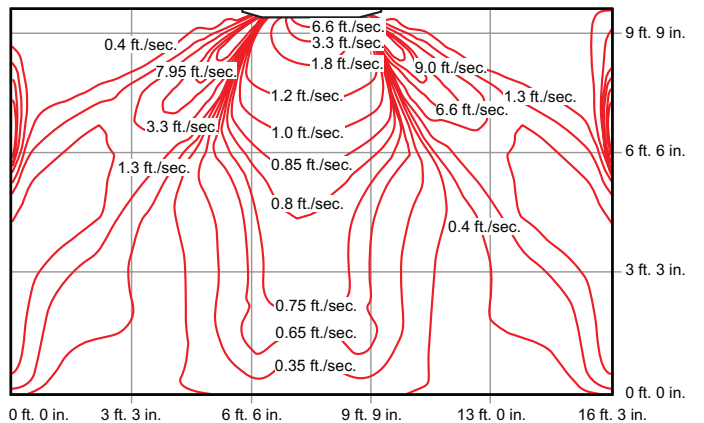

V33B048 - COOLING

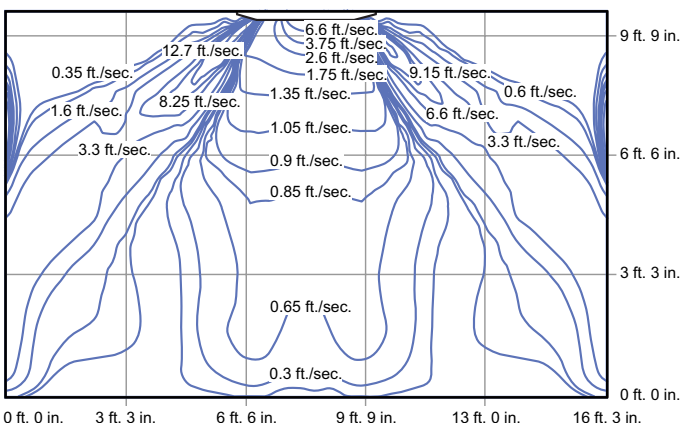

V33B048 - HEATING

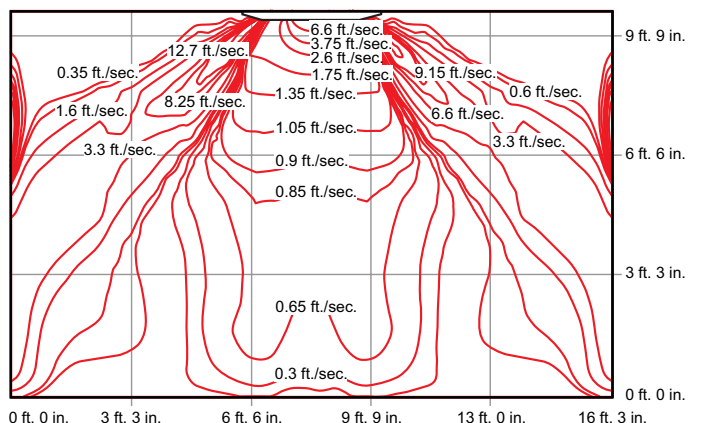

COOLING CAPACITY

Size	Outdoor Temperature °F (Dry Bulb)	Indoor Temperature - °F (Dry Bulb / Wet Bulb)											
		67 / 57		71 / 60		75 / 63		80 / 67		85 / 71		90 / 75	
		Total	Sensible	Total	Sensible	Total	Sensible	Total	Sensible	Total	Sensible	Total	Sensible
		MBH	MBH	MBH	MBH	MBH	MBH	MBH	MBH	MBH	MBH	MBH	MBH
009	5	5.28	3.75	6.40	4.65	7.51	5.59	8.50	6.38	10.49	7.83	11.98	9.02
	10	5.28	3.75	6.40	4.65	7.51	5.59	8.50	6.38	10.49	7.83	11.98	9.02
	15	5.28	3.75	6.40	4.65	7.51	5.59	8.50	6.38	10.49	7.83	11.93	8.99
	20	5.28	3.75	6.40	4.65	7.51	5.59	8.50	6.38	10.49	7.83	11.77	8.86
	25	5.28	3.75	6.40	4.65	7.51	5.59	8.50	6.38	10.49	7.83	11.59	8.73
	30	5.28	3.75	6.40	4.65	7.51	5.59	8.50	6.38	10.49	7.83	11.42	8.60
	35	5.28	3.75	6.40	4.65	7.51	5.59	8.50	6.38	10.49	7.83	11.25	8.47
	40	5.28	3.75	6.40	4.65	7.51	5.59	8.50	6.38	10.49	7.83	11.07	8.34
	45	5.28	3.75	6.40	4.65	7.51	5.59	8.50	6.38	10.49	7.83	10.90	8.21
	50	5.28	3.75	6.40	4.65	7.51	5.59	8.50	6.38	10.49	7.83	10.73	8.08
	55	5.28	3.75	6.40	4.65	7.51	5.59	8.50	6.38	10.47	7.82	10.55	7.95
	60	5.28	3.75	6.40	4.65	7.51	5.59	8.50	6.38	10.30	7.69	10.38	7.82
	65	5.28	3.75	6.40	4.65	7.51	5.59	8.50	6.38	10.12	7.56	10.21	7.69
	70	5.28	3.75	6.40	4.65	7.51	5.59	8.50	6.38	9.95	7.43	10.04	7.56
	75	5.28	3.75	6.40	4.65	7.51	5.59	8.50	6.38	9.78	7.30	9.86	7.43
	80	5.28	3.75	6.40	4.65	7.51	5.59	8.50	6.38	9.60	7.17	9.69	7.30
	85	5.28	3.75	6.40	4.65	7.51	5.59	8.50	6.38	9.43	7.04	9.52	7.17
	90	5.28	3.75	6.40	4.65	7.51	5.59	8.50	6.38	9.26	6.91	9.35	7.04
95	5.28	3.75	6.40	4.65	7.51	5.59	8.50	6.38	9.09	6.78	9.17	6.91	
100	5.28	3.75	6.40	4.65	7.51	5.59	8.34	6.26	8.91	6.66	8.99	6.77	
105	5.28	3.75	6.40	4.65	7.51	5.59	8.17	6.14	8.71	6.51	8.72	6.57	
110	5.28	3.75	6.40	4.65	7.51	5.59	7.96	5.98	8.34	6.22	8.46	6.37	
115	5.28	3.75	6.12	4.45	6.27	4.66	6.47	4.86	6.67	4.98	6.87	5.18	
118	5.02	3.56	5.17	3.76	5.32	3.95	5.52	4.14	5.72	4.27	5.92	4.46	
012	5	7.04	5.00	8.53	6.21	10.02	7.45	12.00	9.01	13.98	10.44	15.97	12.03
	10	7.04	5.00	8.53	6.21	10.02	7.45	12.00	9.01	13.98	10.44	15.97	12.03
	15	7.04	5.00	8.53	6.21	10.02	7.45	12.00	9.01	13.98	10.44	15.91	11.98
	20	7.04	5.00	8.53	6.21	10.02	7.45	12.00	9.01	13.98	10.44	15.69	11.82
	25	7.04	5.00	8.53	6.21	10.02	7.45	12.00	9.01	13.98	10.44	15.45	11.64
	30	7.04	5.00	8.53	6.21	10.02	7.45	12.00	9.01	13.98	10.44	15.22	11.47
	35	7.04	5.00	8.53	6.21	10.02	7.45	12.00	9.01	13.98	10.44	14.99	11.29
	40	7.04	5.00	8.53	6.21	10.02	7.45	12.00	9.01	13.98	10.44	14.76	11.12
	45	7.04	5.00	8.53	6.21	10.02	7.45	12.00	9.01	13.98	10.44	14.53	10.95
	50	7.04	5.00	8.53	6.21	10.02	7.45	12.00	9.01	13.98	10.44	14.30	10.77
	55	7.04	5.00	8.53	6.21	10.02	7.45	12.00	9.01	13.96	10.42	14.07	10.60
	60	7.04	5.00	8.53	6.21	10.02	7.45	12.00	9.01	13.73	10.25	13.84	10.43
	65	7.04	5.00	8.53	6.21	10.02	7.45	12.00	9.01	13.50	10.08	13.61	10.25
	70	7.04	5.00	8.53	6.21	10.02	7.45	12.00	9.01	13.27	9.91	13.38	10.08
	75	7.04	5.00	8.53	6.21	10.02	7.45	12.00	9.01	13.04	9.73	13.15	9.91
	80	7.04	5.00	8.53	6.21	10.02	7.45	12.00	9.01	12.81	9.56	12.92	9.73
	85	7.04	5.00	8.53	6.21	10.02	7.45	12.00	9.01	12.58	9.39	12.69	9.56
	90	7.04	5.00	8.53	6.21	10.02	7.45	12.00	9.01	12.35	9.22	12.46	9.39
95	7.04	5.00	8.53	6.21	10.02	7.45	12.00	9.01	12.12	9.05	12.23	9.21	
100	7.04	5.00	8.53	6.21	10.02	7.45	11.77	8.84	11.89	8.87	11.99	9.03	
105	7.04	5.00	8.53	6.21	10.02	7.45	11.54	8.67	11.62	8.67	11.63	8.76	
110	7.04	5.00	8.53	6.21	10.02	7.45	10.85	8.15	11.12	8.30	11.27	8.49	
115	7.04	5.00	8.16	5.94	8.36	6.22	8.63	6.48	8.89	6.64	9.16	6.90	
118	6.69	4.75	6.89	5.01	7.09	5.27	7.36	5.52	7.62	5.69	7.89	5.94	

NOTE - MBH = 1000 BTUs per hour.

COOLING CAPACITY

Size	Outdoor Temperature °F (Dry Bulb)	Indoor Temperature - °F (Dry Bulb / Wet Bulb)											
		67 / 57		71 / 60		75 / 63		80 / 67		85 / 71		90 / 75	
		Total	Sensible	Total	Sensible	Total	Sensible	Total	Sensible	Total	Sensible	Total	Sensible
		MBH	MBH	MBH	MBH	MBH	MBH	MBH	MBH	MBH	MBH	MBH	MBH
015	5	8.80	6.25	10.66	7.76	12.52	9.31	15.00	11.26	17.48	13.05	19.96	15.03
	10	8.80	6.25	10.66	7.76	12.52	9.31	15.00	11.26	17.48	13.05	19.96	15.03
	15	8.80	6.25	10.66	7.76	12.52	9.31	15.00	11.26	17.48	13.05	19.89	14.98
	20	8.80	6.25	10.66	7.76	12.52	9.31	15.00	11.26	17.48	13.05	19.61	14.77
	25	8.80	6.25	10.66	7.76	12.52	9.31	15.00	11.26	17.48	13.05	19.32	14.55
	30	8.80	6.25	10.66	7.76	12.52	9.31	15.00	11.26	17.48	13.05	19.03	14.33
	35	8.80	6.25	10.66	7.76	12.52	9.31	15.00	11.26	17.48	13.05	18.74	14.12
	40	8.80	6.25	10.66	7.76	12.52	9.31	15.00	11.26	17.48	13.05	18.45	13.90
	45	8.80	6.25	10.66	7.76	12.52	9.31	15.00	11.26	17.48	13.05	18.17	13.68
	50	8.80	6.25	10.66	7.76	12.52	9.31	15.00	11.26	17.48	13.05	17.88	13.47
	55	8.80	6.25	10.66	7.76	12.52	9.31	15.00	11.26	17.45	13.03	17.59	13.25
	60	8.80	6.25	10.66	7.76	12.52	9.31	15.00	11.26	17.16	12.81	17.30	13.03
	65	8.80	6.25	10.66	7.76	12.52	9.31	15.00	11.26	16.87	12.60	17.02	12.82
	70	8.80	6.25	10.66	7.76	12.52	9.31	15.00	11.26	16.58	12.38	16.73	12.60
	75	8.80	6.25	10.66	7.76	12.52	9.31	15.00	11.26	16.30	12.17	16.44	12.38
	80	8.80	6.25	10.66	7.76	12.52	9.31	15.00	11.26	16.01	11.95	16.15	12.17
	85	8.80	6.25	10.66	7.76	12.52	9.31	15.00	11.26	15.72	11.74	15.86	11.95
	90	8.80	6.25	10.66	7.76	12.52	9.31	15.00	11.26	15.43	11.52	15.58	11.73
95	8.80	6.25	10.66	7.76	12.52	9.31	15.00	11.26	15.14	11.31	15.29	11.52	
100	8.80	6.25	10.66	7.76	12.52	9.31	14.71	11.05	14.86	11.09	14.99	11.29	
105	8.80	6.25	10.66	7.76	12.52	9.31	14.42	10.83	14.52	10.84	14.54	10.95	
110	8.80	6.25	10.66	7.76	12.52	9.31	13.56	10.18	13.90	10.37	14.09	10.61	
115	8.80	6.25	10.20	7.42	10.45	7.77	10.78	8.10	11.12	8.30	11.45	8.63	
118	8.36	5.94	8.61	6.27	8.86	6.59	9.20	6.90	9.53	7.11	9.86	7.43	
018	5	11.15	7.92	13.50	9.82	15.86	11.79	18.00	13.52	22.14	16.53	25.28	19.04
	10	11.15	7.92	13.50	9.82	15.86	11.79	18.00	13.52	22.14	16.53	25.28	19.04
	15	11.15	7.92	13.50	9.82	15.86	11.79	18.00	13.52	22.14	16.53	25.19	18.98
	20	11.15	7.92	13.50	9.82	15.86	11.79	18.00	13.52	22.14	16.53	24.84	18.71
	25	11.15	7.92	13.50	9.82	15.86	11.79	18.00	13.52	22.14	16.53	24.47	18.43
	30	11.15	7.92	13.50	9.82	15.86	11.79	18.00	13.52	22.14	16.53	24.10	18.16
	35	11.15	7.92	13.50	9.82	15.86	11.79	18.00	13.52	22.14	16.53	23.74	17.88
	40	11.15	7.92	13.50	9.82	15.86	11.79	18.00	13.52	22.14	16.53	23.38	17.61
	45	11.15	7.92	13.50	9.82	15.86	11.79	18.00	13.52	22.14	16.53	23.01	17.33
	50	11.15	7.92	13.50	9.82	15.86	11.79	18.00	13.52	22.14	16.53	22.65	17.06
	55	11.15	7.92	13.50	9.82	15.86	11.79	18.00	13.52	22.10	16.50	22.28	16.78
	60	11.15	7.92	13.50	9.82	15.86	11.79	18.00	13.52	21.73	16.23	21.92	16.51
	65	11.15	7.92	13.50	9.82	15.86	11.79	18.00	13.52	21.37	15.96	21.55	16.23
	70	11.15	7.92	13.50	9.82	15.86	11.79	18.00	13.52	21.01	15.68	21.19	15.96
	75	11.15	7.92	13.50	9.82	15.86	11.79	18.00	13.52	20.64	15.41	20.82	15.69
	80	11.15	7.92	13.50	9.82	15.86	11.79	18.00	13.52	20.28	15.14	20.46	15.41
	85	11.15	7.92	13.50	9.82	15.86	11.79	18.00	13.52	19.91	14.87	20.09	15.14
	90	11.15	7.92	13.50	9.82	15.86	11.79	18.00	13.52	19.55	14.59	19.73	14.86
95	11.15	7.92	13.50	9.82	15.86	11.79	18.00	13.52	19.18	14.32	19.37	14.59	
100	11.15	7.92	13.50	9.82	15.86	11.79	17.65	13.26	18.82	14.05	18.99	14.30	
105	11.15	7.92	13.50	9.82	15.86	11.79	17.31	13.00	18.39	13.73	18.42	13.87	
110	11.15	7.92	13.50	9.82	15.86	11.79	16.27	12.22	17.60	13.14	17.85	13.45	
115	11.15	7.92	12.92	9.40	13.24	9.84	13.66	10.26	14.08	10.51	14.50	10.93	
118	10.59	7.52	10.91	7.94	11.22	8.35	11.65	8.75	12.07	9.01	12.49	9.41	

NOTE - MBH = 1000 BTUs per hour.

COOLING CAPACITY

Size	Outdoor Temperature °F (Dry Bulb)	Indoor Temperature - °F (Dry Bulb / Wet Bulb)											
		67 / 57		71 / 60		75 / 63		80 / 67		85 / 71		90 / 75	
		Total	Sensible	Total	Sensible	Total	Sensible	Total	Sensible	Total	Sensible	Total	Sensible
		MBH	MBH	MBH	MBH	MBH	MBH	MBH	MBH	MBH	MBH	MBH	MBH
024	5	14.08	10.00	17.06	12.41	20.03	14.90	24.00	18.02	27.97	20.88	31.93	24.05
	10	14.08	10.00	17.06	12.41	20.03	14.90	24.00	18.02	27.97	20.88	31.93	24.05
	15	14.08	10.00	17.06	12.41	20.03	14.90	24.00	18.02	27.97	20.88	31.82	23.97
	20	14.08	10.00	17.06	12.41	20.03	14.90	24.00	18.02	27.97	20.88	31.37	23.63
	25	14.08	10.00	17.06	12.41	20.03	14.90	24.00	18.02	27.97	20.88	30.91	23.28
	30	14.08	10.00	17.06	12.41	20.03	14.90	24.00	18.02	27.97	20.88	30.45	22.93
	35	14.08	10.00	17.06	12.41	20.03	14.90	24.00	18.02	27.97	20.88	29.99	22.59
	40	14.08	10.00	17.06	12.41	20.03	14.90	24.00	18.02	27.97	20.88	29.53	22.24
	45	14.08	10.00	17.06	12.41	20.03	14.90	24.00	18.02	27.97	20.88	29.07	21.89
	50	14.08	10.00	17.06	12.41	20.03	14.90	24.00	18.02	27.97	20.88	28.61	21.55
	55	14.08	10.00	17.06	12.41	20.03	14.90	24.00	18.02	27.91	20.84	28.15	21.20
	60	14.08	10.00	17.06	12.41	20.03	14.90	24.00	18.02	27.45	20.50	27.68	20.85
	65	14.08	10.00	17.06	12.41	20.03	14.90	24.00	18.02	26.99	20.15	27.22	20.51
	70	14.08	10.00	17.06	12.41	20.03	14.90	24.00	18.02	26.53	19.81	26.76	20.16
	75	14.08	10.00	17.06	12.41	20.03	14.90	24.00	18.02	26.07	19.47	26.30	19.81
	80	14.08	10.00	17.06	12.41	20.03	14.90	24.00	18.02	25.61	19.12	25.84	19.47
	85	14.08	10.00	17.06	12.41	20.03	14.90	24.00	18.02	25.15	18.78	25.38	19.12
	90	14.08	10.00	17.06	12.41	20.03	14.90	24.00	18.02	24.69	18.44	24.92	18.77
95	14.08	10.00	17.06	12.41	20.03	14.90	24.00	18.02	24.23	18.09	24.46	18.43	
100	14.08	10.00	17.06	12.41	20.03	14.90	23.54	17.68	23.77	17.75	23.99	18.07	
105	14.08	10.00	17.06	12.41	20.03	14.90	23.08	17.33	23.23	17.35	23.27	17.53	
110	14.08	10.00	17.06	12.41	20.03	14.90	21.70	16.29	22.23	16.60	22.55	16.98	
115	14.08	10.00	16.32	11.87	16.72	12.43	17.25	12.96	17.79	13.28	18.32	13.80	
118	13.38	9.50	13.78	10.02	14.18	10.54	14.71	11.05	15.25	11.38	15.78	11.89	
030	5	17.60	12.50	21.32	15.51	25.04	18.62	30.00	22.53	34.96	26.10	39.92	30.07
	10	17.60	12.50	21.32	15.51	25.04	18.62	30.00	22.53	34.96	26.10	39.92	30.07
	15	17.60	12.50	21.32	15.51	25.04	18.62	30.00	22.53	34.96	26.10	39.78	29.96
	20	17.60	12.50	21.32	15.51	25.04	18.62	30.00	22.53	34.96	26.10	39.22	29.54
	25	17.60	12.50	21.32	15.51	25.04	18.62	30.00	22.53	34.96	26.10	38.63	29.10
	30	17.60	12.50	21.32	15.51	25.04	18.62	30.00	22.53	34.96	26.10	38.06	28.67
	35	17.60	12.50	21.32	15.51	25.04	18.62	30.00	22.53	34.96	26.10	37.48	28.23
	40	17.60	12.50	21.32	15.51	25.04	18.62	30.00	22.53	34.96	26.10	36.91	27.80
	45	17.60	12.50	21.32	15.51	25.04	18.62	30.00	22.53	34.96	26.10	36.33	27.37
	50	17.60	12.50	21.32	15.51	25.04	18.62	30.00	22.53	34.96	26.10	35.76	26.93
	55	17.60	12.50	21.32	15.51	25.04	18.62	30.00	22.53	34.89	26.05	35.18	26.50
	60	17.60	12.50	21.32	15.51	25.04	18.62	30.00	22.53	34.32	25.62	34.61	26.07
	65	17.60	12.50	21.32	15.51	25.04	18.62	30.00	22.53	33.74	25.19	34.03	25.63
	70	17.60	12.50	21.32	15.51	25.04	18.62	30.00	22.53	33.17	24.76	33.45	25.20
	75	17.60	12.50	21.32	15.51	25.04	18.62	30.00	22.53	32.59	24.33	32.88	24.77
	80	17.60	12.50	21.32	15.51	25.04	18.62	30.00	22.53	32.02	23.90	32.30	24.33
	85	17.60	12.50	21.32	15.51	25.04	18.62	30.00	22.53	31.44	23.47	31.73	23.90
	90	17.60	12.50	21.32	15.51	25.04	18.62	30.00	22.53	30.86	23.04	31.15	23.47
95	17.60	12.50	21.32	15.51	25.04	18.62	30.00	22.53	30.29	22.61	30.58	23.03	
100	17.60	12.50	21.32	15.51	25.04	18.62	29.42	22.09	29.71	22.18	29.98	22.58	
105	17.60	12.50	21.32	15.51	25.04	18.62	28.85	21.66	29.04	21.68	29.08	21.91	
110	17.60	12.50	21.32	15.51	25.04	18.62	27.12	20.37	27.79	20.75	28.18	21.23	
115	17.60	12.50	20.40	14.84	20.90	15.54	21.57	16.20	22.23	16.60	22.90	17.25	
118	16.72	11.88	17.22	12.53	17.72	13.18	18.39	13.81	19.06	14.23	19.72	14.86	

NOTE - MBH = 1000 BTUs per hour.

COOLING CAPACITY

Size	Outdoor Temperature °F (Dry Bulb)	Indoor Temperature - °F (Dry Bulb / Wet Bulb)											
		67 / 57		71 / 60		75 / 63		80 / 67		85 / 71		90 / 75	
		Total	Sensible	Total	Sensible	Total	Sensible	Total	Sensible	Total	Sensible	Total	Sensible
		MBH	MBH	MBH	MBH	MBH	MBH	MBH	MBH	MBH	MBH	MBH	MBH
036	5	22.30	15.84	27.01	19.65	31.72	23.59	36.00	27.03	44.28	33.06	50.56	38.09
	10	22.30	15.84	27.01	19.65	31.72	23.59	36.00	27.03	44.28	33.06	50.56	38.09
	15	22.30	15.84	27.01	19.65	31.72	23.59	36.00	27.03	44.28	33.06	50.38	37.95
	20	22.30	15.84	27.01	19.65	31.72	23.59	36.00	27.03	44.28	33.06	49.68	37.42
	25	22.30	15.84	27.01	19.65	31.72	23.59	36.00	27.03	44.28	33.06	48.94	36.86
	30	22.30	15.84	27.01	19.65	31.72	23.59	36.00	27.03	44.28	33.06	48.21	36.31
	35	22.30	15.84	27.01	19.65	31.72	23.59	36.00	27.03	44.28	33.06	47.48	35.76
	40	22.30	15.84	27.01	19.65	31.72	23.59	36.00	27.03	44.28	33.06	46.75	35.21
	45	22.30	15.84	27.01	19.65	31.72	23.59	36.00	27.03	44.28	33.06	46.02	34.67
	50	22.30	15.84	27.01	19.65	31.72	23.59	36.00	27.03	44.28	33.06	45.29	34.12
	55	22.30	15.84	27.01	19.65	31.72	23.59	36.00	27.03	44.20	33.00	44.56	33.57
	60	22.30	15.84	27.01	19.65	31.72	23.59	36.00	27.03	43.47	32.46	43.83	33.02
	65	22.30	15.84	27.01	19.65	31.72	23.59	36.00	27.03	42.74	31.91	43.11	32.47
	70	22.30	15.84	27.01	19.65	31.72	23.59	36.00	27.03	42.01	31.37	42.38	31.92
	75	22.30	15.84	27.01	19.65	31.72	23.59	36.00	27.03	41.28	30.82	41.65	31.37
	80	22.30	15.84	27.01	19.65	31.72	23.59	36.00	27.03	40.55	30.28	40.92	30.82
	85	22.30	15.84	27.01	19.65	31.72	23.59	36.00	27.03	39.82	29.73	40.19	30.27
	90	22.30	15.84	27.01	19.65	31.72	23.59	36.00	27.03	39.09	29.19	39.46	29.72
95	22.30	15.84	27.01	19.65	31.72	23.59	36.00	27.03	38.37	28.64	38.73	29.17	
100	22.30	15.84	27.01	19.65	31.72	23.59	35.31	26.51	37.64	28.10	37.98	28.61	
105	22.30	15.84	27.01	19.65	31.72	23.59	34.62	26.00	36.79	27.47	36.84	27.75	
110	22.30	15.84	27.01	19.65	31.72	23.59	33.55	25.19	35.20	26.28	35.70	26.89	
115	22.30	15.84	25.84	18.80	26.47	19.69	27.32	20.51	28.16	21.03	29.01	21.85	
118	21.18	15.05	21.82	15.87	22.45	16.69	23.29	17.49	24.14	18.02	24.98	18.82	
048	5	28.17	20.01	34.12	24.82	40.07	29.79	48.00	36.04	55.93	41.76	63.87	48.11
	10	28.17	20.01	34.12	24.82	40.07	29.79	48.00	36.04	55.93	41.76	63.87	48.11
	15	28.17	20.01	34.12	24.82	40.07	29.79	48.00	36.04	55.93	41.76	63.64	47.94
	20	28.17	20.01	34.12	24.82	40.07	29.79	48.00	36.04	55.93	41.76	62.75	47.26
	25	28.17	20.01	34.12	24.82	40.07	29.79	48.00	36.04	55.93	41.76	61.82	46.56
	30	28.17	20.01	34.12	24.82	40.07	29.79	48.00	36.04	55.93	41.76	60.89	45.87
	35	28.17	20.01	34.12	24.82	40.07	29.79	48.00	36.04	55.93	41.76	59.97	45.18
	40	28.17	20.01	34.12	24.82	40.07	29.79	48.00	36.04	55.93	41.76	59.05	44.48
	45	28.17	20.01	34.12	24.82	40.07	29.79	48.00	36.04	55.93	41.76	58.13	43.79
	50	28.17	20.01	34.12	24.82	40.07	29.79	48.00	36.04	55.93	41.76	57.21	43.09
	55	28.17	20.01	34.12	24.82	40.07	29.79	48.00	36.04	55.83	41.68	56.29	42.40
	60	28.17	20.01	34.12	24.82	40.07	29.79	48.00	36.04	54.91	41.00	55.37	41.71
	65	28.17	20.01	34.12	24.82	40.07	29.79	48.00	36.04	53.99	40.31	54.45	41.01
	70	28.17	20.01	34.12	24.82	40.07	29.79	48.00	36.04	53.07	39.62	53.53	40.32
	75	28.17	20.01	34.12	24.82	40.07	29.79	48.00	36.04	52.15	38.93	52.61	39.63
	80	28.17	20.01	34.12	24.82	40.07	29.79	48.00	36.04	51.22	38.25	51.69	38.93
	85	28.17	20.01	34.12	24.82	40.07	29.79	48.00	36.04	50.30	37.56	50.77	38.24
	90	28.17	20.01	34.12	24.82	40.07	29.79	48.00	36.04	49.38	36.87	49.84	37.55
95	28.17	20.01	34.12	24.82	40.07	29.79	48.00	36.04	48.46	36.18	48.92	36.85	
100	28.17	20.01	34.12	24.82	40.07	29.79	47.08	35.35	47.54	35.50	47.97	36.13	
105	28.17	20.01	34.12	24.82	40.07	29.79	46.16	34.66	46.47	34.70	46.53	35.05	
110	28.17	20.01	34.12	24.82	40.07	29.79	43.40	32.59	44.46	33.20	45.09	33.97	
115	28.17	20.01	32.64	23.75	33.44	24.87	34.51	25.91	35.58	26.56	36.64	27.60	
118	26.76	19.01	27.56	20.05	28.36	21.09	29.42	22.09	30.49	22.77	31.56	23.77	

NOTE - MBH = 1000 BTUs per hour.

HEATING CAPACITY

Size	Outdoor Temperature (°F)		Indoor Temperature - °F (Dry Bulb)					
			61	64	67	70	73	75
	Dry Bulb	Wet Bulb	Total Capacity					
			MBH	MBH	MBH	MBH	MBH	MBH
009	-13	-14	4.92	4.70	4.48	4.26	4.04	3.89
	-8	-9	5.51	5.28	5.06	4.84	4.62	4.47
	-3	-4	6.09	5.87	5.65	5.42	5.20	5.05
	2	1	6.67	6.45	6.23	6.01	5.78	5.64
	7	6	7.25	7.03	6.81	6.59	6.37	6.22
	12	10	7.72	7.50	7.28	7.06	6.83	6.69
	17	15	8.30	8.08	7.86	7.64	7.42	7.27
	22	20	8.89	8.66	8.44	8.22	8.00	7.85
	27	24	9.35	9.13	8.91	8.69	8.47	8.32
	32	29	9.94	9.71	9.49	9.27	9.05	8.90
	37	34	10.52	10.30	10.08	9.85	9.63	9.48
	42	38	10.98	10.76	10.54	10.32	10.10	9.63
	47	43	11.57	11.35	11.12	10.90	10.14	9.63
	52	47	12.03	11.81	11.59	10.90	10.14	9.63
	57	52	12.62	12.40	11.66	10.90	10.14	9.63
	62	56	13.08	12.42	11.66	10.90	10.14	9.63
	67	61	13.18	12.42	11.66	10.90	10.14	9.63
72	66	13.18	12.42	11.66	10.90	10.14	9.63	
75	69	13.18	12.42	11.66	10.90	10.14	9.63	
012	-13	-14	5.34	5.07	4.79	4.51	4.24	4.05
	-8	-9	6.14	5.86	5.59	5.31	5.03	4.85
	-3	-4	6.94	6.66	6.38	6.11	5.83	5.65
	2	1	7.74	7.46	7.18	6.91	6.63	6.44
	7	6	8.53	8.26	7.98	7.70	7.43	7.24
	12	10	9.17	8.89	8.62	8.34	8.06	7.88
	17	15	9.97	9.69	9.41	9.14	8.86	8.68
	22	20	10.77	10.49	10.21	9.94	9.66	9.47
	27	24	11.40	11.13	10.85	10.57	10.30	10.11
	32	29	12.20	11.92	11.65	11.37	11.09	10.91
	37	34	13.00	12.72	12.44	12.17	11.89	11.71
	42	38	13.64	13.36	13.08	12.81	12.53	12.02
	47	43	14.43	14.16	13.88	13.60	12.65	12.02
	52	47	15.07	14.79	14.52	13.60	12.65	12.02
	57	52	15.87	15.50	14.55	13.60	12.65	12.02
	62	56	16.45	15.50	14.55	13.60	12.65	12.02
	67	61	16.45	15.50	14.55	13.60	12.65	12.02
72	66	16.45	15.50	14.55	13.60	12.65	12.02	
75	69	16.45	15.50	14.55	13.60	12.65	12.02	

NOTE - MBH = 1000 BTUs per hour.

HEATING CAPACITY

Size	Outdoor Temperature (°F)		Indoor Temperature - °F (Dry Bulb)					
			61	64	67	70	73	75
	Dry Bulb	Wet Bulb	Total Capacity					
			MBH	MBH	MBH	MBH	MBH	MBH
015	-13	-14	7.68	7.33	6.99	6.64	6.29	6.06
	-8	-9	8.59	8.24	7.90	7.55	7.20	6.97
	-3	-4	9.50	9.15	8.80	8.46	8.11	7.88
	2	1	10.41	10.06	9.71	9.37	9.02	8.79
	7	6	11.31	10.97	10.62	10.28	9.93	9.70
	12	10	12.04	11.70	11.35	11.00	10.66	10.43
	17	15	12.95	12.61	12.26	11.91	11.57	11.34
	22	20	13.86	13.51	13.17	12.82	12.48	12.25
	27	24	14.59	14.24	13.90	13.55	13.20	12.97
	32	29	15.50	15.15	14.80	14.46	14.11	13.88
	37	34	16.41	16.06	15.71	15.37	15.02	14.79
	42	38	17.13	16.79	16.44	16.09	15.75	15.02
	47	43	18.04	17.70	17.35	17.00	15.81	15.02
	52	47	18.77	18.42	18.08	17.00	15.81	15.02
	57	52	19.68	19.33	18.19	17.00	15.81	15.02
	62	56	20.40	19.37	18.19	17.00	15.81	15.02
	67	61	20.56	19.37	18.19	17.00	15.81	15.02
	72	66	20.56	19.37	18.19	17.00	15.81	15.02
75	69	20.56	19.37	18.19	17.00	15.81	15.02	
018	-13	-14	9.71	9.27	8.84	8.40	7.96	7.67
	-8	-9	10.86	10.42	9.99	9.55	9.11	8.82
	-3	-4	12.01	11.57	11.14	10.70	10.26	9.97
	2	1	13.16	12.72	12.29	11.85	11.41	11.12
	7	6	14.31	13.87	13.43	13.00	12.56	12.27
	12	10	15.23	14.79	14.35	13.92	13.48	13.19
	17	15	16.38	15.94	15.50	15.07	14.63	14.34
	22	20	17.53	17.09	16.65	16.22	15.78	15.49
	27	24	18.45	18.01	17.57	17.14	16.70	16.41
	32	29	19.60	19.16	18.72	18.29	17.85	17.56
	37	34	20.75	20.31	19.87	19.44	19.00	18.71
	42	38	21.67	21.23	20.79	20.35	19.92	19.00
	47	43	22.82	22.38	21.94	21.00	20.00	19.00
	52	47	23.74	23.30	22.86	21.00	20.00	19.00
	57	52	24.89	24.45	23.00	21.00	20.00	19.00
	62	56	25.81	24.50	23.00	21.00	20.00	19.00
	67	61	26.00	24.50	23.00	21.00	20.00	19.00
	72	66	26.00	24.50	23.00	21.00	20.00	19.00
75	69	26.00	24.50	23.00	21.00	20.00	19.00	

NOTE - MBH = 1000 BTUs per hour.

HEATING CAPACITY

Size	Outdoor Temperature (°F)		Indoor Temperature - °F (Dry Bulb)					
			61	64	67	70	73	75
	Dry Bulb	Wet Bulb	Total Capacity					
		MBH	MBH	MBH	MBH	MBH	MBH	
024	-13	-14	12.95	12.40	11.85	11.30	10.75	10.38
	-8	-9	14.23	13.69	13.14	12.59	12.04	11.67
	-3	-4	15.54	14.99	14.44	13.89	13.34	12.98
	2	1	16.87	16.32	15.77	15.22	14.67	14.30
	7	6	18.21	17.66	17.11	16.56	16.01	15.65
	12	10	19.30	18.75	18.20	17.65	17.10	16.73
	17	15	20.67	20.12	19.57	19.02	18.47	18.11
	22	20	22.06	21.51	20.97	20.42	19.87	19.50
	27	24	23.19	22.64	22.09	21.54	20.99	20.63
	32	29	24.61	24.07	23.52	22.97	22.42	22.05
	37	34	26.06	25.51	24.96	24.41	23.86	23.49
	42	38	27.22	26.67	26.12	25.57	25.03	23.86
	47	43	28.70	28.15	27.60	27.00	25.12	23.86
	52	47	29.89	29.34	28.79	27.00	25.12	23.86
	57	52	31.39	30.77	28.88	27.00	25.12	23.86
	62	56	32.61	30.77	28.88	27.00	25.12	23.86
	67	61	32.65	30.77	28.88	27.00	25.12	23.86
72	66	32.65	30.77	28.88	27.00	25.12	23.86	
75	69	32.65	30.77	28.88	27.00	25.12	23.86	
030	-13	-14	13.82	13.12	12.43	11.74	11.05	10.59
	-8	-9	15.77	15.08	14.39	13.69	13.00	12.54
	-3	-4	17.72	17.03	16.34	15.65	14.95	14.49
	2	1	19.68	18.98	18.29	17.60	16.91	16.45
	7	6	21.63	20.94	20.25	19.55	18.86	18.40
	12	10	23.19	22.50	21.81	21.12	20.42	19.96
	17	15	25.14	24.45	23.76	23.07	22.38	21.92
	22	20	27.10	26.41	25.71	25.02	24.33	23.87
	27	24	28.66	27.97	27.28	26.59	25.89	25.43
	32	29	30.61	29.92	29.23	28.54	27.85	27.39
	37	34	32.57	31.88	31.18	30.49	29.80	29.34
	42	38	34.13	33.44	32.75	32.05	31.36	30.05
	47	43	36.08	35.39	34.70	34.00	31.63	30.05
	52	47	37.65	36.95	36.26	34.00	31.63	30.05
	57	52	39.60	38.74	36.37	34.00	31.63	30.05
	62	56	41.12	38.74	36.37	34.00	31.63	30.05
	67	61	41.12	38.74	36.37	34.00	31.63	30.05
72	66	41.12	38.74	36.37	34.00	31.63	30.05	
75	69	41.12	38.74	36.37	34.00	31.63	30.05	

NOTE - MBH = 1000 BTUs per hour.

HEATING CAPACITY

Size	Outdoor Temperature (°F)		Indoor Temperature - °F (Dry Bulb)					
			61	64	67	70	73	75
	Dry Bulb	Wet Bulb	Total Capacity					
			MBH	MBH	MBH	MBH	MBH	MBH
036	-13	-14	16.50	15.65	14.79	13.94	13.08	12.51
	-8	-9	18.96	18.11	17.25	16.40	15.54	14.98
	-3	-4	21.43	20.57	19.72	18.86	18.01	17.44
	2	1	23.89	23.03	22.18	21.32	20.47	19.90
	7	6	26.35	25.50	24.64	23.79	22.93	22.36
	12	10	28.32	27.47	26.61	25.76	24.90	24.33
	17	15	30.78	29.93	29.07	28.22	27.36	26.80
	22	20	33.25	32.39	31.54	30.68	29.83	29.26
	27	24	35.22	34.36	33.51	32.65	31.80	31.23
	32	29	37.68	36.82	35.97	35.11	34.26	33.69
	37	34	40.14	39.29	38.43	37.58	36.72	36.15
	42	38	42.11	41.26	40.40	39.55	38.69	37.12
	47	43	44.57	43.72	42.86	42.00	39.07	37.12
	52	47	46.54	45.69	44.83	42.00	39.07	37.12
	57	52	49.01	47.86	44.93	42.00	39.07	37.12
	62	56	50.79	47.86	44.93	42.00	39.07	37.12
	67	61	50.79	47.86	44.93	42.00	39.07	37.12
72	66	50.79	47.86	44.93	42.00	39.07	37.12	
75	69	50.79	47.86	44.93	42.00	39.07	37.12	
048	-13	-14	24.61	23.51	22.41	21.31	20.21	19.48
	-8	-9	27.47	26.38	25.28	24.18	23.08	22.35
	-3	-4	30.34	29.24	28.15	27.05	25.95	25.21
	2	1	33.21	32.11	31.01	29.92	28.82	28.08
	7	6	36.08	34.98	33.88	32.78	31.68	30.95
	12	10	38.38	37.28	36.18	35.08	33.98	33.25
	17	15	41.24	40.15	39.05	37.95	36.85	36.12
	22	20	44.11	43.01	41.91	40.82	39.72	38.98
	27	24	46.41	45.31	44.21	43.11	42.01	41.28
	32	29	49.28	48.18	47.08	45.98	44.88	44.15
	37	34	52.14	51.05	49.95	48.85	47.75	47.02
	42	38	54.44	53.34	52.24	51.14	50.04	47.72
	47	43	57.31	56.21	55.11	54.00	50.23	47.72
	52	47	59.60	58.50	57.41	54.00	50.23	47.72
	57	52	62.47	61.37	57.77	54.00	50.23	47.72
	62	56	64.77	61.53	57.77	54.00	50.23	47.72
	67	61	65.30	61.53	57.77	54.00	50.23	47.72
72	66	65.30	61.53	57.77	54.00	50.23	47.72	
75	69	65.30	61.53	57.77	54.00	50.23	47.72	

NOTE - MBH = 1000 BTUs per hour.

REVISIONS

Sections	Description of Change
Specifications	Updated Indoor Blower CFM data for V33B015H4 and V33B024H4.



Visit us at www.lennox.com

For the latest technical information, www.lennoxcommercial.com

Contact us at 1-800-4-LENNOX

NOTE - Due to Lennox' ongoing commitment to quality, Specifications, Ratings and Dimensions subject to change without notice and without incurring liability. Improper installation, adjustment, alteration, service or maintenance can cause property damage or personal injury. Installation and service must be performed by a qualified installer and servicing agency.

©2018 Lennox Industries, Inc.